

Digital Still Camera  
**Read This First**

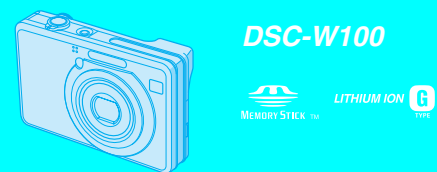

Operating Instructions  
Before operating the unit, please read this manual and "User's Guide/Troubleshooting" (separate volume) thoroughly, and retain them for future reference.



**Checking the accessories supplied**

- Battery charger BC-CSG/BC-CSGB (1)
- Wrist strap (1)
- CD-ROM (Cyber-shot application software) (1)
- Power cord (mains lead) (1)
- Operating instructions: "Read This First" (this manual) (1)
- Operating instructions: "User's Guide/Troubleshooting" (1)
- Rechargeable battery pack NP-BG1 (1)/Battery case (1)
- USB, A/V cable for multi-use terminal (1)

**A "Memory Stick Duo" is not supplied.**

The camera has its own internal memory (64 MB), however, purchase of a "Memory Stick Duo" is recommended for shooting more images.

**"Memory Stick Duo": you can use a "Memory Stick Duo" with your camera.**

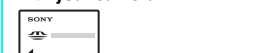

**"Memory Stick": you cannot use a "Memory Stick" with your camera.**



**Other memory cards cannot be used.**

For details on "Memory Stick Duo" → "User's Guide/Troubleshooting" (page 97)

**Notes**

- Charge the battery pack (supplied) before using the camera for the first time.
- The LCD screen is manufactured using extremely high-precision technology so over 99.99% of the pixels are operational for effective use. However, there may be some tiny black points and/or bright points (white, red, blue or green in color) that constantly appear on the LCD screen. These points are normal in the manufacturing process and do not affect the recording in any way.

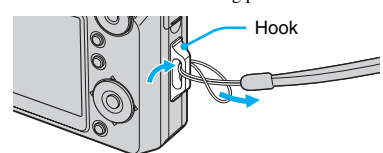

- The camera is a precision instrument. Be careful not to bump the lens or the LCD screen, and not to apply force to it. Attach the strap to prevent the camera from damage by being dropped, etc.

Designed for use with compatible Sony batteries.

Additional information on this product and answers to frequently asked questions can be found at our Customer Support Website.

**1 Prepare the battery pack**

**1 Insert the battery pack.**

Push the battery pack gently until it clicks into place.

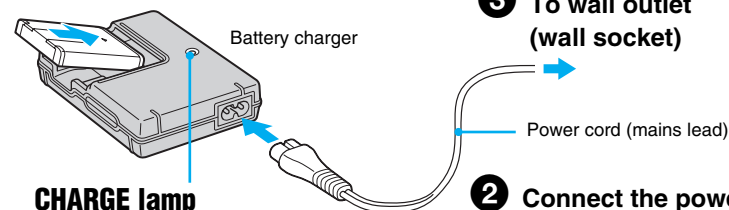

**CHARGE lamp**

Light on: Charging

Light off: Completed (Practical charge)

If you continue charging the battery pack for about one more hour (until it is fully charged), the charge will last slightly longer.

- Connect the battery charger to an easily accessible wall outlet (wall socket) close by.
- Even if the CHARGE lamp is not lit, the battery charger is not disconnected from the AC power source (mains) as long as it is connected to the wall outlet (wall socket). If some trouble occurs while using the battery charger, immediately shut off the power by disconnecting the plug from the wall outlet (wall socket).
- When charging is finished, disconnect the power cord (mains lead) from the wall outlet (wall socket), and remove the battery pack from the battery charger.
- The time required to fully charge the battery pack (supplied) from when it is completely discharged at a temperature of 25°C (77°F) is approximately 330 min., and the practical charging time is approximately 270 min. Charging may take longer under certain circumstances or conditions.

**4 Insert the charged battery pack.**

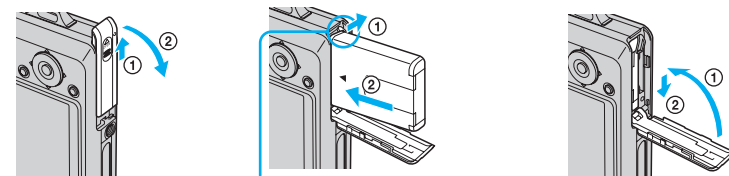

Open the battery/"Memory Stick Duo" cover.  
Insert the battery pack while pressing the battery eject lever with the tip of the battery.  
Close the battery/"Memory Stick Duo" cover.

**2 Turn the camera on/set the clock**

**1 Select**

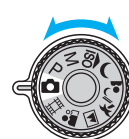

**2 Press the POWER button.**

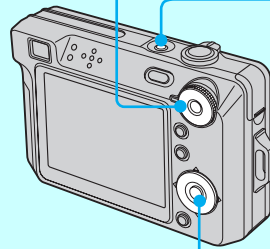
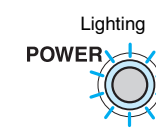

**3 Set the clock with the control button.**

1 Select the date display format with , then press .

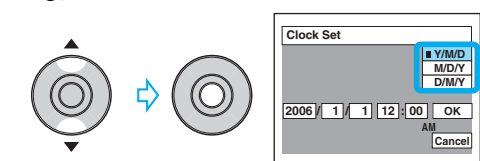

2 Select each item with and set the numeric value with , then press .

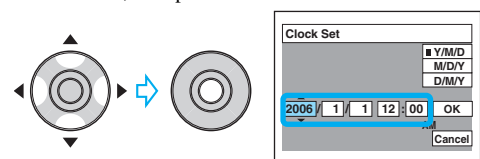

3 Select [OK] with , then press .

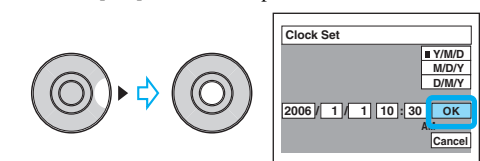

To cancel, select [Cancel] and press .

**3 Insert a "Memory Stick Duo" (not supplied)**

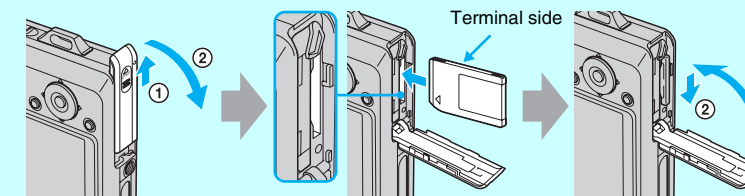

Insert the "Memory Stick Duo" all the way in until it clicks.

**When there is no "Memory Stick Duo" inserted**

The camera records/plays back images using the internal memory (64 MB). → "User's Guide/Troubleshooting" (page 27)

**4 Select the image size for use**

**1 Select a mode.**

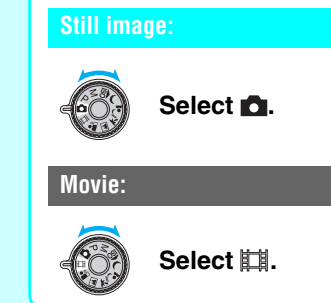

**2 Press / (Image Size).**

**3 Select the size with .**

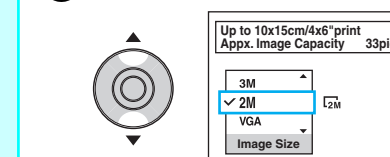

- The screen above is for still images.
- For movies, select [640(Fine)] ("Memory Stick PRO Duo" only), [640(Standard)] or [160].

**4 Press / (Image Size) to complete the setting.**

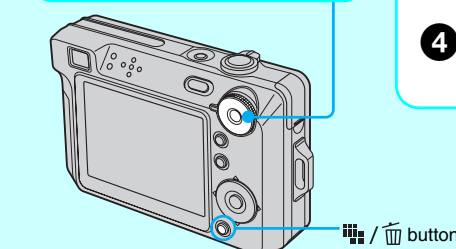

**Using the AC Adaptor**

You can connect the camera to a wall outlet (wall socket) using the AC-LS5K AC Adaptor (not supplied). → "User's Guide/Troubleshooting" (page 19).

**To check the remaining battery time**

Press POWER button to turn on and check the remaining battery on the LCD screen.

Battery remaining indicator					
Battery remaining guidelines	Sufficient power remaining	Battery half full	Battery low, recording/playback will stop soon.	Change the battery with fully charged one, or charge the battery. (The warning indicator flashes.)	

- It takes about one minute until the correct battery remaining indicator appears.
- The displayed battery remaining indicator may not be correct under certain circumstances.

**To remove the battery pack**

Slide the battery eject lever to pull the battery pack out. Be sure not to drop the battery pack when pulling it out.

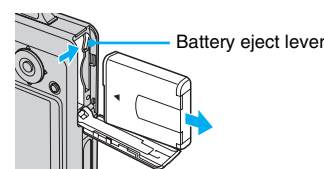

**To use your camera abroad — Power sources**

You can use your camera, the battery charger, and the AC-LS5K AC Adaptor (not supplied) in any country or region where the power supply is within 100 V to 240 V AC, 50/60 Hz.

- Do not use an electronic transformer (travel converter), as this may cause a malfunction.

**To change the date and time**

Select [Clock Set] in the (Setup) screen and perform the procedure in step 3 above. → "User's Guide/Troubleshooting" (pages 48 and 57)

**On the clock display**

- Midnight is indicated as 12:00 AM, and noon as 12:00 PM.
- If you selected [D/M/Y] in step 1, set the time on a 24-hour cycle.

**When turning on the power**

- Unless you set the clock, the Clock Set screen appears each time the camera is turned on.
- Do not touch the lens portion as the cover opens and the lens portion extends. Also, do not leave the camera with the lens portion extended for a long period of time with the power off as this may cause malfunction.
- The following screen appears when the camera is turned on for the second time or afterwards.

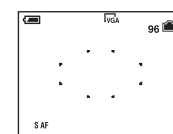

**To turn off the power**

Press the POWER button again.

- If the camera is running on battery power and you do not operate the camera for about three minutes, the camera turns off automatically to prevent wearing down the battery pack (Auto power-off function).

**Changing the language setting**

You can change the screen display to show messages in a specified language. To change the language setting, press MENU to display the menu screen. Select (Setup) with the control button, then, select [A] Language in (Setup1), and select the desired language. → "User's Guide/Troubleshooting" (page 55)

**On still image sizes**

For details on the image size → "User's Guide/Troubleshooting" (page 16)

The default settings are marked with .

Image size	Guidelines	No. of images	Printing
8M	Up to A3/11x17"print	Less	Fine
3:2 <sup>1)</sup>	Match 3:2 Aspect Ratio		
5M	Up to A4/8x10"print	More	Rough
3M	Up to 13x18cm/5x7"print		
2M	Up to 10x15cm/4x6"print		
VGA	For E-mail		
16:9 <sup>2)</sup>	Display On 16:9 HDTV <sup>3)</sup>		

<sup>1)</sup> Images are recorded in the same 3:2 aspect ratio as photograph printing paper or postcards, etc.  
<sup>2)</sup> Both edges of the image may be cut off when printing → "User's Guide/Troubleshooting" (page 91)  
<sup>3)</sup> By using a Memory Stick slot or USB connection, you can enjoy higher quality images.

**On the recordable number of still images and recordable time of movies**

Recordable number of still images and recordable time of movies vary depending on the image size selected.

For details on recordable number or time → "User's Guide/Troubleshooting" (page 25)

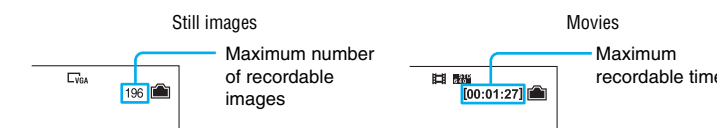

- The number of recordable images and time can differ according to shooting conditions.

**To remove a "Memory Stick Duo"**

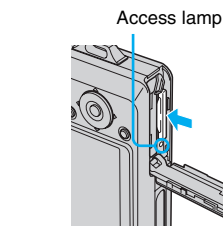

Open the battery/"Memory Stick Duo" cover, then push the "Memory Stick Duo" in once.

**When the access lamp is lit**

Never remove the battery/"Memory Stick Duo" or turn off the power. The data may be corrupted.



# 5 Shoot images easily (Auto adjustment mode)

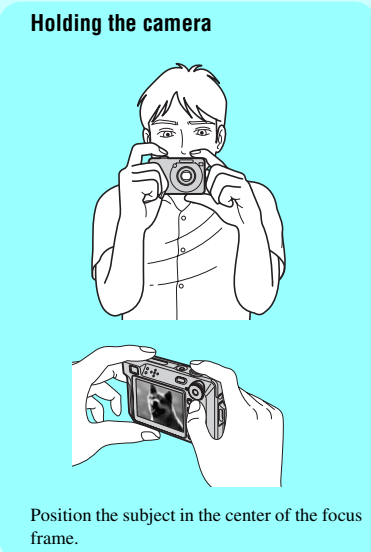

- Select a mode.**  
**Still image (auto adjustment mode):**  
 Select .  
**Movie:**  
 Select .

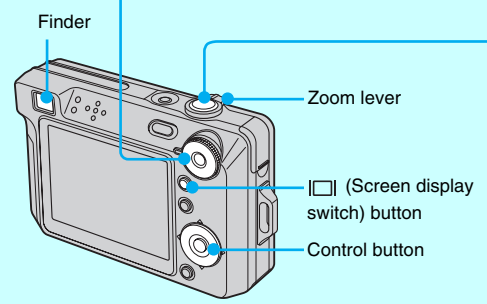

## Using the control button

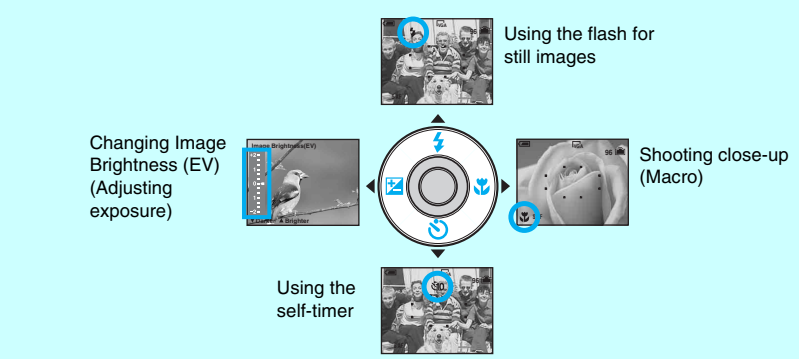

- Shoot with the shutter button.**  
**Still image:**  
 Press and hold the shutter button halfway down to focus. AE/AF lock indicator Flashing → lit/beeps down to focus. Press the shutter button fully down. The shutter sounds.  
  
 AF range finder frame  
**Movie:**  
 Press the shutter button fully down.  
  
 To stop recording, press the shutter button fully down again.

## Using the zoom

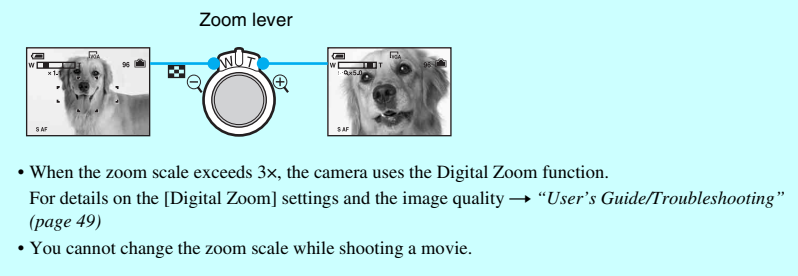

# 6 Shoot still images (Scene Selection)

- Select the desired mode of Scene Selection (ISO, , , , , , ).**  
  
 High Sensitivity ISO  
 Shoot without flash in low-light reducing blur  
 Function Guide  
 • For details on modes, see below.

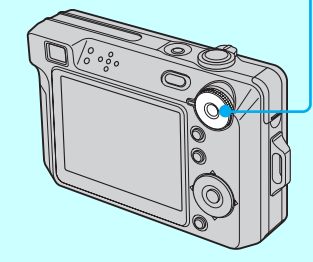

- Shoot with the shutter button.**

## On Function Guide

The operational instructions displayed on the Function Guide are automatically turned off in a few seconds. When you want to cancel the Function Guide, press the Shutter Button half way down. You can set the Function Guide not to be displayed on the [Setup] screen. → “User’s Guide/Troubleshooting” (page 50)

## To cancel the Scene Selection

Set the mode dial to other than the mode of Scene Selection.

# 6 View/delete images

- Press (Playback).**  
 • If you press button when the camera is powered off, the camera is turned on in the playback mode.

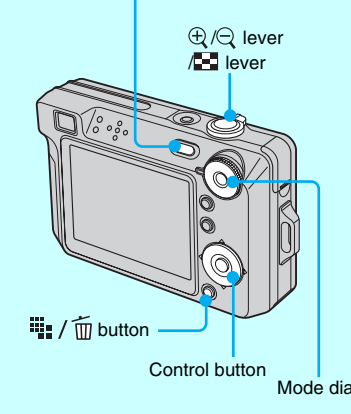

- To return to the shooting mode**
- Press (Playback) again.
  - Press and hold the shutter button halfway down.
  - Change the position of the mode dial.

## To delete images

- 1 Display the image you want to delete and press / (Delete).
- 2 Select [Delete] with , then press .



- Select an image with .**  
 Still image: the image size is displayed  
 Movie: is displayed  
**Movie:**  
 To play back a movie, press .  
  
 Playback bar  
 Rewind/Fast forward: (Return to normal playback: )  
 Volume:   
 Stop playback: .  
 • Movies with the image size [160] are displayed a size smaller.

## Changing Image Brightness (EV) (Adjusting exposure)

Before Step 2, press on the control button. Adjust the image brightness with (Brighter) / (Darker). To delete the displayed scale bar, press again.



- The compensation value can be set in 1/3EV increments.
- If a subject is being shot in extremely bright or dark conditions, or the flash is used, the exposure adjustment may not be effective.
- For details on the exposure → “User’s Guide/Troubleshooting” (page 14)

## Selecting a flash mode for still images

Before step 2, press on the control button repeatedly until the desired mode is selected.

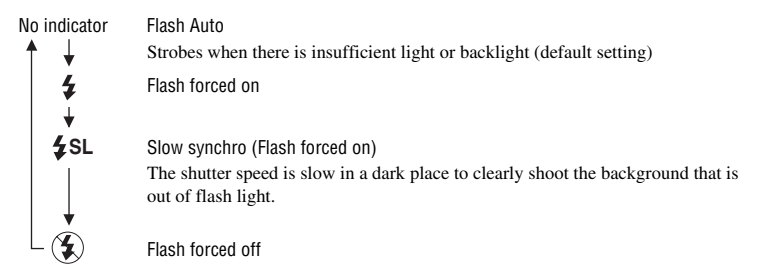

- Shooting distance (when [ISO] is set to [Auto])  
 W side: Approx. 0.2 to 6 m (7 7/8 inches to 19 feet 8 7/8 inches)  
 T side: Approx. 0.3 to 3.2 m (11 7/8 inches to 10 feet 6 3/8 inches)
- The flash strobos twice. The first time is to adjust the light quantity.

## Shooting close-up (Macro)

Before step 2, press on the control button. To cancel, press again.

- Setting the zoom all the way to the W side is recommended.
- The in-focus range becomes narrow, and the complete subject may not entirely be in focus.
- The Auto Focus speed drops.

**Shortest shooting distance from the lens surface**  
 Setting all the way to the W side: Approx. 6 cm (2 3/8 inches)  
 Setting all the way to the T side: Approx. 30 cm (11 7/8 inches)

## Using the self-timer

Before Step 2, press on the control button repeatedly until the desired mode is selected.

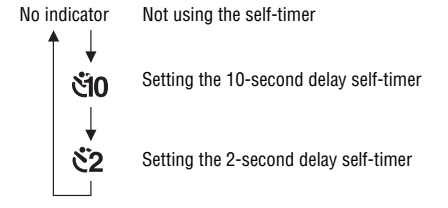

Press the shutter button, the self-timer lamp flashes, and a beep sounds until the shutter operates.

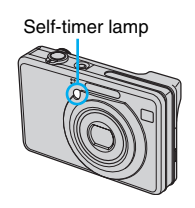

To cancel, press again.  
 • If you use the 2-second delay self-timer, you may prevent blur.

## If you shoot a still image of a subject that is difficult to focus on

- The shortest shooting distance is 50 cm (19 3/4 inches). Shoot in the close-up (Macro) mode (left) when shooting a subject closer than the shortest shooting distance.
- When the camera cannot focus on the subject automatically, the AE/AF lock indicator changes to flashing slowly and the beep does not sound. Reposition the shot and focus again.

### Subjects difficult to focus on are:

- Distant from the camera and dark
- Moving fast
- The contrast between the subject and its background is poor.
- Reflective light or with a lustrous finish
- Flashing
- Seen through glass
- Backlit

## To brighten up the display

If you view images in bright outside light, adjust the brightness of the LCD backlight up. However, the battery power may decrease faster under such condition.

If you press (Screen display switch) button longer (above), the backlight brightens. If you press again, the backlight is cancelled.

## To identify items on the screen

→ “User’s Guide/Troubleshooting” (page 20)

## To turn off the LCD screen

Press (Screen display switch) button (above) repeatedly. Use the finder (above) for saving battery power, or shooting images when it is difficult to confirm using the LCD screen.

## Scene Selection modes

The following modes are predetermined to match the scene conditions.

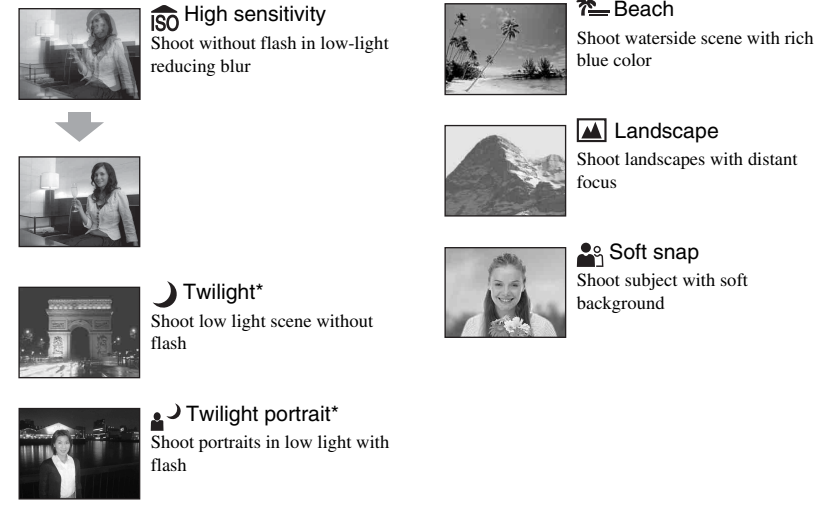

\*The shutter speed becomes slower, so using a tripod is recommended.

## To use the functions set by the control button with Scene Selection

Before shooting in step 2, select the settings with the control button. Some functions are not available, depending on the Scene Selection mode. When you press the button to select functions that cannot be combined with Scene Selection, a beep sounds. → “User’s Guide/Troubleshooting” (page 30)

## To view an enlarged image (playback zoom)

Slide to the side while displaying a still image. To undo the zoom, slide to the side.

Adjust the portion: /

Cancel playback zoom:

To store enlarged images: [Trimming] → “User’s Guide/Troubleshooting” (page 47)

## Viewing an index screen

Slide (Index) lever to the side and select an image with / .

To return to the single-image screen, press . To display the next (previous) index screen, press .

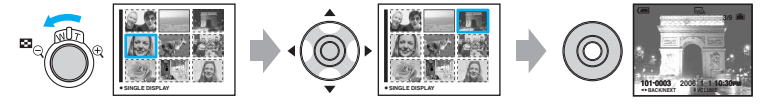

## To delete images in index mode

- 1 While an index screen is displayed, press / (Delete) and select [Select] with on the control button, then press .
- 2 Select the image you want to delete with / , then press to display the (Delete) indicator on the selected image.

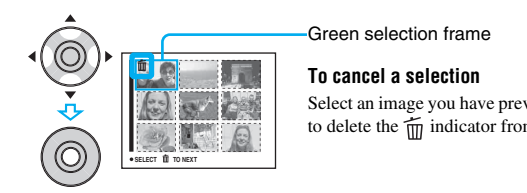

Green selection frame

**To cancel a selection**  
 Select an image you have previously selected for deletion, then press to delete the indicator from the image.

3 Press / (Delete).

4 Select [OK] with , then press .

• To delete all the images in the folder, select [All In This Folder] with in step 1 instead of [Select], then press .