



WARNING

To reduce the risk of fire or electric shock, do not expose this apparatus to rain or moisture.

To reduce the risk of fire, do not cover the ventilation of the apparatus with newspapers, tablecloths, curtains, etc. And do not place lighted candles on the apparatus.

To reduce the risk of fire or electric shock, do not place objects filled with liquids, such as vases, on the apparatus.

Connect the unit to an easily accessible AC outlet. Should you notice an abnormality in the unit, disconnect the main plug from the AC outlet immediately.

Do not install the appliance in a confined space, such as a bookcase or built-in cabinet.

CAUTION

The use of optical instruments with this product will increase eye hazard.

Note on DualDiscs

A DualDisc is a two sided disc product which mates DVD recorded material on one side with digital audio material on the other side. However, since the audio material side does not conform to the Compact Disc (CD) standard, playback on this product is not guaranteed.

Music discs encoded with copyright protection technologies

This product is designed to playback discs that conform to the Compact Disc (CD) standard. Recently, various music discs encoded with copyright protection technologies are marketed by some record companies. Please be aware that among those discs, there are some that do not conform to the CD standard and may not be playable by this product.

MPEG Layer-3 audio coding technology and patents licensed from Fraunhofer IIS and Thomson.

Except for customers in the U.S.A. and Canada

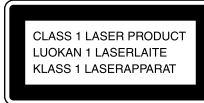

This appliance is classified as a CLASS 1 LASER product. This marking is located on the rear exterior.

Hooking up the system securely

DC IN 12V jack

You can connect a DC power source to the DC IN 12V jack. If the AC power supply is cut off (because of a power failure, for example), the power source automatically switches to DC power. When the AC power supply resumes, the system returns to AC power operation.

- The STANDBY indicator [2] lights up in green when power is being supplied through the DC IN jack.
- The outer electrode of the DC IN 12V jack is - (minus) and the inner one is + (plus).
- Be sure not to connect the DC IN 12V jack to a car cigarette lighter socket.

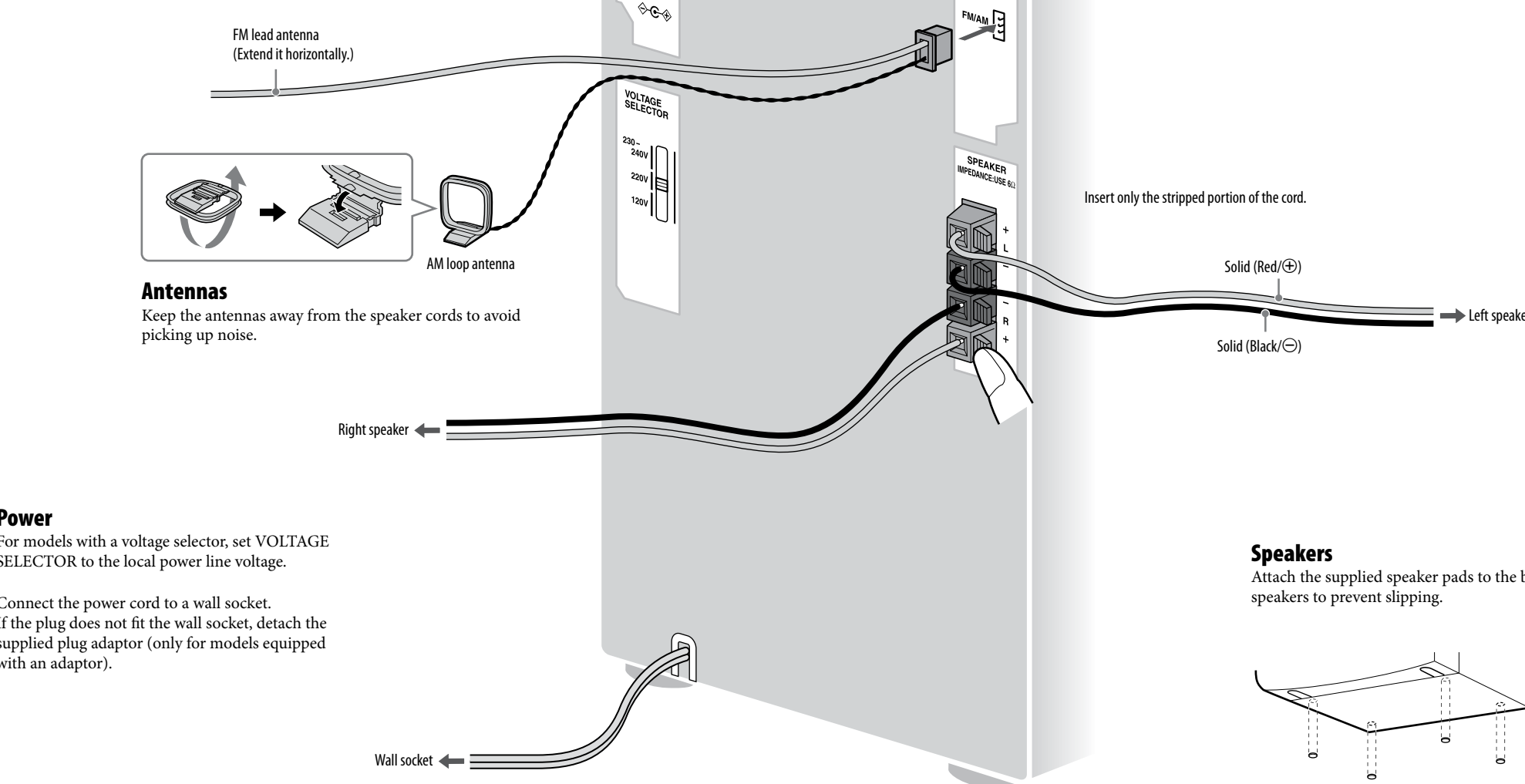

When carrying this system

- Remove all discs to protect the CD mechanism.
- Hold down CD ►|| (play/pause) on the unit, and press I/⏻ until "STANDBY" appears.
- After "LOCK" appears, unplug the power cord.

Speakers
Attach the supplied speaker pads to the bottom of the speakers to prevent slipping.

Basic Operations

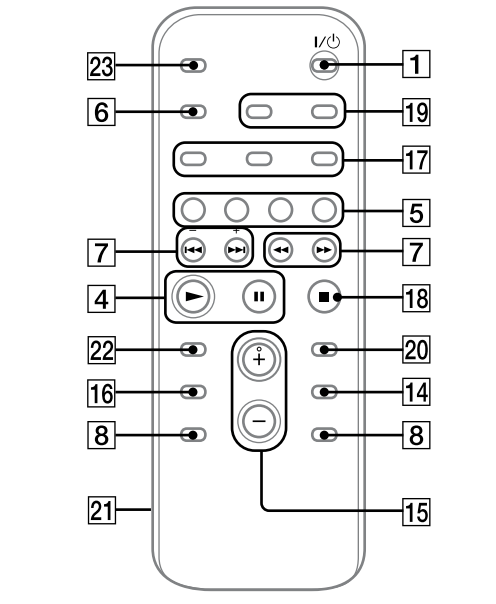
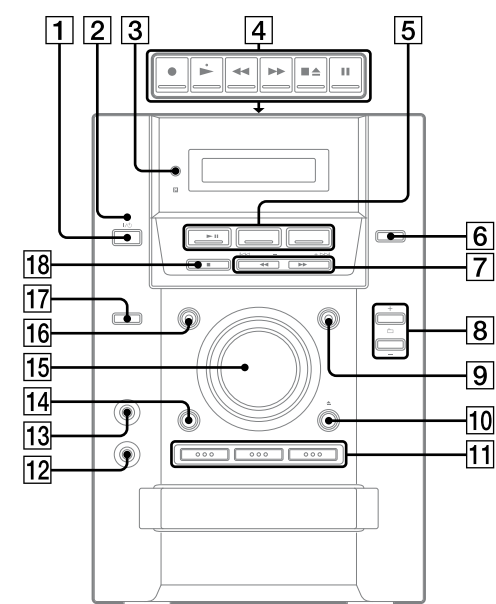

Adjusting the sound

To adjust the volume

Press VOLUME +/- on the remote (or turn the VOLUME control on the unit) [15].

To add a sound effect

To	Press
Generate a more dynamic sound (Dynamic Sound Generator X-tra)	DSGX [9] on the unit.
Set the sound effect	EQ [16].

Playing a CD/MP3 disc

1 Select the CD function.

Press CD on the remote (or FUNCTION repeatedly) [5].

2 Place a disc.

Press ▲ (open/close) [10] on the unit, and place a disc with the label side up on the disc tray. To place additional discs, slide the disc tray with your finger as shown below.

To close the disc tray, press ▲ (open/close) [10] on the unit.

Do not force the disc tray closed with your finger, as this may damage the unit.

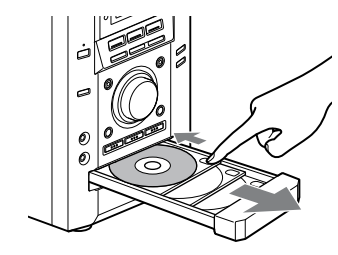

3 Select a disc.

If the discs are currently stopped, press DISC SKIP on the remote (or DISC SKIP/EX-CHANGE on the unit) [14]. To change discs while in other functions, press DISC 1 - 3 [11] on the unit.

4 Start playback.

Press ► (play) [4] on the remote (or CD ►|| (play/pause) [5] on the unit).

To exchange other discs during playback, press DISC SKIP/EX-CHANGE [14] on the unit.

To	Press
Pause playback	(pause) [4] on the remote (or CD ► [5] on the unit). To resume play, press it again.
Stop playback	■ (stop) [18].
Select a folder on an MP3 disc	⏪ +/- [8].
Select a track or file	⏪ / ►► (go back/go forward) on the remote (⏪ << >> ►► on the unit) [7].
Find a point in a track or file	Hold down ◀◀ / ▶▶ (rewind/fast forward) [7] during playback, and release it at the desired point.
Select Repeat Play	REPEAT [17] on the remote repeatedly until "REP" or "REP1" appears.

To change the play mode

Press PLAY MODE [17] repeatedly while the player is stopped. You can select normal play (no display for all discs or "1 DISC" for a disc or "F" for all MP3 files in the folder on the disc), shuffle play ("SHUF" for all discs shuffle, "1 DISC SHUF" for one disc shuffle or "F SHUF" for folder shuffle), or program play ("PGM").

* When playing a CD-DA disc, [SHUF] Play performs the same operation as 1 DISC (SHUF) Play.

Notes on Repeat Play

- All tracks or files on a disc are played repeatedly up to five times.
- You cannot select "REP" and "SHUF" (all discs shuffle) at the same time.
- "REP1" indicates that a single track or file is repeated until you stop it.

Notes on playing MP3 discs

- Do not save other types of tracks or files or unnecessary folders on a disc that has MP3 files.
- Folders that have no MP3 files are skipped.
- MP3 files are played back in the order that they are recorded onto the disc.
- The system can only play MP3 files that have a file extension of ".MP3".
- If there are files on the disc that have the ".MP3" file extension, but that are not MP3 files, the unit may produce noise or may malfunction.
- The maximum number of:
 - folders is 150 (including the root folder).
 - MP3 files is 255.
 - MP3 files and folders that can be contained on a single disc is 256.
 - folder levels (the tree structure of files) is eight.
- Compatibility with all MP3 encoding/writing software, recording device, and recording media cannot be guaranteed. Incompatible MP3 discs may produce noise or interrupted audio or may not play at all.

Selecting a music source

Press the following buttons (or press FUNCTION [5] repeatedly).

To select	Press
CD	CD [5] on the remote.
Tuner	TUNER/BAND [5].
Tape	TAPE [5] on the remote.
Component* (connected using an audio cord)	FUNCTION [5] repeatedly until "AUDIO IN" appears.

* If the component has the AVLS (Automatic Volume Limiter System) or BASS BOOST function, turn off the function to avoid distorted sound from the speakers.

Notes on playing multisession discs

- If the disc begins with a CD-DA (or MP3) session, it is recognized as a CD-DA (or MP3) disc, and playback continues until another session is encountered.
- A disc with a mixed CD format is recognized as a CD-DA (audio) disc.

Listening to the radio

1 Select "FM" or "AM."

Press TUNER/BAND [5] repeatedly.

2 Select the tuning mode.

Press TUNING MODE [17] repeatedly until "AUTO" appears.

3 Tune in the desired station.

Press +/- on the remote (or TUNING + or - on the unit) [7]. Scanning stops automatically when a station is tuned in.

To stop automatic scanning

Press ■ (stop) [18].

To tune in a station with a weak signal

Press TUNING MODE [17] repeatedly until "MANUAL" appears, and then press +/- on the remote repeatedly (or TUNING + or - on the unit) [7] to tune in the desired station.

To reduce static noise on a weak FM stereo station

Press FM MODE [17] on the remote repeatedly until "MONO" appears to turn off stereo reception.

Playing a tape

Use buttons on the unit for the operation.

1 Select a tape function.

Press FUNCTION repeatedly (or TAPE on the remote) [5].

2 Insert a tape.

Press ■▲ (stop/eject) [4] on the unit, and insert the tape into the cassette holder. Make sure there is no slack in the tape to avoid damaging the tape or the tape deck.

3 Start playback.

Press ► (play) [4] on the unit.

To	Press
Pause playback	(pause) [4] on the unit. To resume play, press it again.
Stop playback	■▲ (stop/eject) [4] on the unit.
Rewind or fast forward*	◀◀ / ▶▶ [4] on the unit.

* Be sure to press ■▲ (stop/eject) [4] on the unit after the tape has been wound or rewound to the end.

Note

Do not turn off the system during playback or recording.

Changing the display

To change	Press
Information on the display ¹⁾	DISPLAY [6] repeatedly when the system is on.
Display mode (Clock)	DISPLAY [6] when the system is off ²⁾ . The clock is displayed for eight seconds.

¹⁾ For example, you can view CD/MP3 disc information, such as the track or file number or folder name during normal play, or the total play time while the player is stopped.

²⁾ The STANDBY indicator [2] lights up in red when the system is turned off.

Notes on the display information

- The following are not displayed:
 - total playing time for a CD-DA disc depending on the play mode.
 - total playing time for an MP3 disc.
 - remaining playing time for a track and an MP3 file.
- The following are not displayed correctly:
 - elapsed playing time of an MP3 file encoded using a VBR (variable bit rate).
 - folder and file names that do not follow either the ISO9660 Level 1, Level 2 or Joliet in the expansion format.
- The following are displayed:
 - ID3 tag information for MP3 files when ID3 version 1 and version 2 tags are used.
 - up to 15 characters of ID3 tag information using uppercase letters (A to Z), numbers (0 to 9), and symbols (<> * +, - / @ [\] _).

Using optional audio components

To connect an optional headphones

Connect headphones to the PHONES jack [12] on the unit.

To connect an optional component

Connect additional audio source components to the AUDIO IN jack [13] on the unit using an audio cord (not supplied). Turn down the volume on the system, and then select the AUDIO IN function.

Other Operations

Creating your own CD program (Program Play)

Use buttons on the remote to create your own program.

1 Press CD ◻5 to select the CD function.

2 Press PLAY MODE ◻17 repeatedly until “PGM” appears while the player is stopped.

3 Press DISC SKIP ◻14 to select a disc.

4 Press ◀◀▶▶1 (or ◀◀▶▶1 on the unit) ◻7 repeatedly until the desired track number appears.

When programing MP3 files, press ◻+/- ◻8 repeatedly to select the desired folder, and then select the desired file.

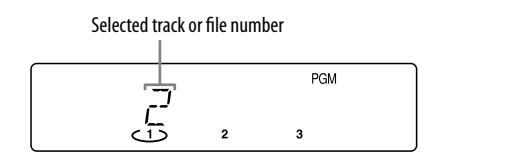

5 Press ENTER ◻20 to add the track or file to the program.

6 Repeat steps 3 through 5 to program additional tracks or files, up to a total of 15 tracks or files.

7 To play your program of tracks or files, press ▶ ◻4 (or CD/▶◻▶◻▶◻ on the unit).

The program remains available until you open the disc tray. To play it again, select the CD function, and press ▶ ◻4 (or CD▶◻▶◻▶◻ on the unit).

To cancel Program Play, press PLAY MODE ◻17 repeatedly until “PGM” disappears while the player is stopped.

To delete the last track or file of the program, press CLEAR ◻22 on the remote while the player is stopped.

To view program information, such as total track number of the program, press DISPLAY ◻6 repeatedly.

Presetting radio stations

You can preset your favorite radio stations and tune them in instantly by selecting the corresponding preset number.

Use buttons on the remote to preset stations.

1 Press TUNER/BAND ◻5 repeatedly to select “FM” or “AM.”

2 Press TUNING MODE ◻17 repeatedly until “AUTO” appears (or “MANUAL” appears, for a station with a weak signal).

3 Press +/- (or TUNING + or − on the unit) ◻7 to tune in the desired station.

Scanning stops automatically when a station is tuned in, and then “TUNED” and “STEREO” (for stereo programs) appear.

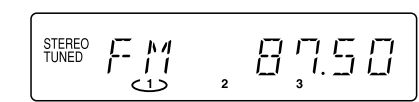

If “TUNED” does not appear and the scanning does not stop, press TUNING MODE ◻17 until “MANUAL” appears and press +/- (or TUNING + or − on the unit) ◻7 repeatedly to tune in the desired station.

4 Press TUNER MEMORY ◻17 on the remote.

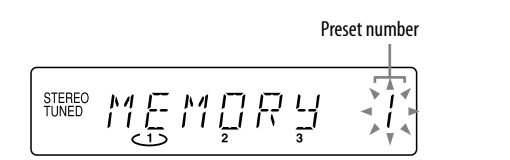

5 Press +/- (or TUNING + or − on the unit) ◻7 repeatedly to select your desired preset number.

If another station is already assigned to the selected preset number, the station is replaced by the new stations.

6 Press ENTER ◻20.

7 Repeat steps 1 through 6 to store other stations.

You can preset up to 20 FM and 10 AM stations. The preset stations are retained for about half a day even if you disconnect the power cord or if a power failure occurs.

8 To call up a preset radio station, press TUNING MODE ◻17 repeatedly until “PRESET” appears, and then press +/- (or TUNING + or − on the unit) repeatedly ◻7 to select the desired preset number.

To change the AM tuning interval from the factory preset to 9 kHz (or 10 kHz, for some areas), tune in any AM station, and then turn off the system. Press DISPLAY ◻6 to display the clock and while holding down TUNING + ◻7 on the unit, press I/◻1 on the unit. All the AM preset stations are erased. To reset the interval to the factory preset, repeat the procedure.

Recording onto a tape

Use a TYPE I (normal) tape only.

You can record just the portions you like from a sound source, including connected audio components.

Use buttons on the unit to control tape recording.

1 Insert a recordable tape into the cassette holder with the side you want to record facing up.

2 Prepare the recording source.

Select the desired source to record.

Place the disc you want to record and press DISC SKIP ◻14 to select a disc.

When recording a folder from an MP3 disc, press PLAY MODE ◻17 repeatedly to select “◻” and then press ◻+/- ◻8 repeatedly to select the desired folder. To record only your favorite CD tracks or MP3 files in your desired order, perform steps 2 to 5 of “Creating your own CD program.”

3 Start recording.

Press ● (record) ◻4, and then start playing the desired recording source.

The CD starts playing automatically.

If there is noise while recording from the tuner, reposition the appropriate antenna to reduce the noise.

While recording, you cannot listen to other sources.

To stop recording, press ■▲ ◻4.

Tip

We recommend that you press ■▲ ◻4 first, and then press ■▲ ◻4 to avoid noise being recorded when you stop recording.

Using the timers

The system offers two timer functions. If you use both timers, the Sleep Timer has priority.

Sleep Timer:

You can fall asleep to music. This function works even if the clock is not set.

Press SLEEP ◻23 on the remote repeatedly. If you select “AUTO,” the system automatically turns off after the current disc or tape stops or in 100 minutes.

If the tape deck is still playing or recording at the set time, the system turns off after the tape deck stops.

Play Timer:

You can wake up to CD or tuner at a preset time.

Use buttons on the remote to control the Play Timer. Make sure you have set the clock.

1 Prepare the sound source.

Prepare the sound source, and then press VOLUME +/- (or turn the VOLUME control on the unit) ◻15 to adjust the volume.

To start from a specific CD track or MP3 file, create your own CD program.

2 Press CLOCK/TIMER SET ◻19.

3 Press ◀◀▶▶1 ◻7 repeatedly to select “PLAY,” and then press ENTER ◻20.

“ON TIME” appears, and the hour indication flashes.

4 Set the time to start playing.

Press ◀◀▶▶1 ◻7 repeatedly to set the hour, and then press ENTER ◻20.

The minute indication flashes. Use the procedure above to set the minute.

5 Use the same procedure as in step 4 to set the time to stop playing.

6 Select the sound source.

Press ◀◀▶▶1 ◻7 repeatedly until the desired sound source appears, and then press ENTER ◻20. The display shows the timer settings.

7 Press I/◻1 to turn off the system.

If the system is on at the preset time, the Play Timer will not play.

To activate or check the timer again, press CLOCK/TIMER SELECT ◻19, press ◀◀▶▶1 ◻7 repeatedly until “PLAY” appears, and then press ENTER ◻20.

To cancel a timer, repeat the same procedure as above until “OFF” appears, and then press ENTER ◻20.

To change the setting, start over from step 1.

Tip

The Play Timer setting remains as long as the setting is not canceled manually.

Troubleshooting

1 Make sure the power cord and speaker cords are correctly and firmly connected.

2 Find your problem in the checklist below, and take the indicated corrective action.

If the issue persists, contact your nearest Sony dealer.

If the STANDBY indicator flashes <p>Immediately unplug the power cord, and check the following item.</p> <ul style="list-style-type: none">If your system has a voltage selector, is the voltage selector set to the correct voltage? After the STANDBY indicator ◻2 stops flashing, reconnect the power cord, and turn on the system. If the issue persists, contact your nearest Sony dealer.
--

General

There is no sound.

- Are the + and − speaker cords short-circuited?
- Are you using only the supplied speakers?
- Is anything blocking the ventilation holes on the back of the system?

Sound comes from one channel, or the left and right volumes are unbalanced.

- Place the speakers as symmetrically as possible.
- Connect only the supplied speakers.

Severe hum or noise.

- Move the system away from sources of noise.
- Connect the system to a different wall socket.
- Install a noise filter (available separately) to the power cord.

The remote does not function.

- Remove any obstacles between the remote and the remote sensor ◻3 on the unit, and position the unit away from fluorescent lights.
- Point the remote at the system’s sensor.
- Move the remote closer to the system.

CD/MP3 player

The sound skips, or the disc will not play.

- Wipe the disc clean, and replace it.
- Move the system to a location away from vibration (for example, on top of a stable stand).
- Move the speakers away from the system, or place them on separate stands. At high volume, speaker vibration may cause the sound to skip.

Play does not start from the first track.

- Return to Normal Play by pressing PLAY MODE ◻17 repeatedly until both “PGM” and “SHUF” disappear.

Starting playback takes more time than usual.

- The following discs take a longer time to start playback.
 - a disc recorded with a complicated tree structure.
 - a disc recorded in multisession mode.
 - a disc that has not been finalized (a disc to which data can be added).
 - a disc that has many folders.

The disc tray does not open and “LOCKED” appears.
<ul style="list-style-type: none">Contact your Sony dealer or local authorized Sony service facility.

Tuner

Severe hum or noise, or stations cannot be received. (“TUNED” or “STEREO” flashes on the display.)

- Connect the antenna properly.
- Find a location and an orientation that provide good reception, and then set up the antenna again.
- Turn off nearby electrical equipment.

Tape deck

The sound exhibits excessive wow or flutter or dropout.

- Clean the capstans and pinch rollers. Also, clean and demagnetize the tape heads. See “Precautions” for details.

To improve tuner reception

Turn off CD player power by using the CD power management function. By default, CD power is turned on. Use buttons on the unit to turn off CD player power.

1 Press CD on the remote (or FUNCTION repeatedly) ◻5 to select the CD function.

2 Press I/◻1 to turn off the system.

3 After “STANDBY” stops flashing, press DISPLAY ◻6 to display the clock and then press I/◻1 while holding down ■ ◻18 on the unit.

“CD POWER OFF” appears. With CD player power turned off, disc access time is increased. To turn on CD player power, repeat the procedure until “CD POWER ON” appears.

To reset the system to factory settings

If the system still does not operate properly, reset the system to factory settings.

Use buttons on the unit to reset the unit to its factory default settings.

1 Disconnect and reconnect the power cord, and then turn on the system.

2 Press ■ ◻18, DSGX ◻9, and I/◻1 at the same time. All user-configured settings, such as preset radio stations, timer, and the clock, are deleted.

Messages

CANNOT LOCK : The system cannot be locked after you have done the procedure of “When carrying this system.”

COMPLETE : The preset operation ended normally.

FULL : You tried to program more than 15 tracks (steps).
LOCKED : The disc tray does not open. Contact your nearest Sony dealer.

LOW DC: The voltage supplied to the DC IN 12V jack is insufficient.

NO DISC: There is no disc in the player, or you have loaded a disc that cannot be played.

NO STEP: All of the programed tracks have been erased.

NOT USED : You pressed an invalid button.

OVER : You have reached the end of the disc while pressing ▶▶ ◻7 during playback or pause.

PUSH SELECT : You tried to set the clock or timer during timer operation.

PUSH STOP : You pressed PLAY MODE ◻17 during playback.

READING : The system is reading information from the disc. Some buttons are not available.

SET CLOCK : You tried to select the timer when the clock is not set.

SET TIMER : You tried to select the timer when the Play Timer is not set.

TIMING : The Play Timer start and end times are set to the same time.

Display	indicates
◻ 2	2 (two)
◻ 6	6 (six)
◻ 8	8 (eight)
◻ A	A
◻ B	B
◻ D	D
◻ G	G
◻ H	H
◻ K	K
◻ M	M
◻ O or 0 (zero)	
◻ Q	Q
◻ R	R
◻ S or 5 (five)	
◻ Z	Z
◻ ,	,
◻ @	@

Precautions

- Discs that this system CAN play**
- Audio CD
 - CD-R/CD-RW (audio data/MP3 files)

Discs that this system CANNOT play

- CD-ROM
- CD-R/CD-RW other than those recorded in music CD format or MP3 format conforming to ISO9660 Level 1/Level 2, Joliet or multisession
- CD-R/CD-RW recorded in multisession that have not ended by “closing the session”
- CD-R/CD-RW of poor recording quality, CD-R/CD-RW that have scratches or are dirty, or CD-R/CD-RW recorded with an incompatible recording device
- CD-R/CD-RW which is finalized incorrectly
- Discs containing files other than MPEG 1 Audio Layer-3 (MP3) files
- Discs of non-standard shape (for example, heart, square, star)
- Discs that have adhesive tape, paper, or sticker attached to them
- Rental or used discs with attached seals where the glue extends beyond the seal
- Discs that have labels printed using ink that feels tacky when touched

Notes on discs

- Before playing, wipe the disc with a cleaning cloth from the center out to the edge.
- Do not clean discs with solvents, such as benzine thinner, or commercially available cleaners or anti-static spray intended for vinyl LPs.
- Do not expose discs to direct sunlight or heat sources such as hot air ducts, nor leave it in a car parked in direct sunlight.

On safety

- The unit is not disconnected from the AC power source (mains) as long as it is connected to the wall socket, even if the unit itself has been turned off.
- Completely disconnect the power cord (mains lead) from the wall socket (mains) if it is not going to be used for an extended period of time. When unplugging the unit, always grip the plug. Never pull the cord itself.
- Should any solid object or liquid get into the system, unplug the system, and have it checked by qualified personnel before operating it again.
- The AC power cord can be changed only by a qualified service facility.

On placement

• Do not place the system in an inclined position or in locations that are extremely hot, cold, dusty, dirty, or humid or lacking adequate ventilation, or subject to vibration, direct sunlight or a bright light.

- Be careful when placing the unit or speakers on surfaces that have been specially treated (for example, with wax, oil, polish) as staining or discoloration of the surface may result.

• If the system is brought directly from a cold to a warm location or is placed in a very damp room, moisture may condense on the lens inside the CD player, and cause the system to malfunction. In this situation, remove the disc, and leave the system turned on for about an hour until the moisture evaporates.

On heat buildup

- Heat buildup on the unit during operation is normal and is not cause for alarm.
- Do not touch the cabinet if it has been used continuously at a high volume because the cabinet may have become hot.
- Do not obstruct the ventilation holes.

On the speaker system

This speaker system is not magnetically shielded, and the picture on nearby TV sets may become magnetically distorted. In this situation, turn off the TV, wait 15 to 30 minutes, and turn it back on.

If there is no improvement, move the speakers far away from the TV.

Cleaning the cabinet

Clean this system with a soft cloth slightly moistened with a mild detergent solution. Do not use any type of abrasive pad, scouring powder, or solvent, such as thinner, benzine, or alcohol.

To prevent a tape from being accidentally recorded over

Break off the cassette’s overwrite protection tab from side A or B as illustrated.

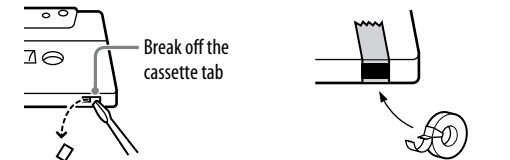

To later reuse the tape for recording, cover the broken tab with adhesive tape.

About a tape longer than 90 minutes

The use of the tape with more than 90 minutes of play time is not recommended except for long, continuous recording or playback.

Cleaning the tape heads

Use dry- or wet-type cleaning cassette (available separately) after every 10 hours of use, before you start an important recording, or after playing an old tape. Failure to clean the tape heads can cause degraded sound quality or an inability of the unit to record or play tapes. For details, refer to the instructions of the cleaning cassette.

Demagnetizing the tape heads

Use a demagnetizing cassette (available separately) after every 20 to 30 hours of use. Failure to demagnetize the tape heads can cause an increase in noise, a loss of high frequency sound, and an inability to completely erase tapes. For details, refer to the instructions of the demagnetizing cassette.

Specifications

Main unit
Amplifier section DIN power output (rated): 40 + 40 W (6 ohms at 1 kHz, DIN) Continuous RMS power output (reference): 50 + 50 W