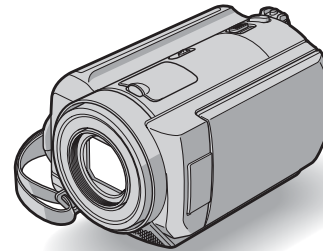

SONY®

2-887-134-11(1)

*Digital Video Camera Recorder***HANDYCAM®****Operating Guide****DCR-SR40/SR60/SR80**

Additional information on this product and answers to frequently asked questions can be found at our Customer Support Website.

<http://www.sony.net/>



Printed on 100% recycled paper using VOC (Volatile Organic Compound)-free vegetable oil based ink.

Printed in Japan

**Also refer to “Handycam Handbook” (PDF)**

By referring to “Handycam Handbook” (PDF) contained in the supplied CD-ROM, you can find more detailed information on how to use the camcorder.

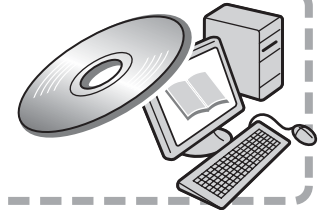

© 2006 Sony Corporation

WARNING

To reduce fire or shock hazard, do not expose the unit to rain or moisture.

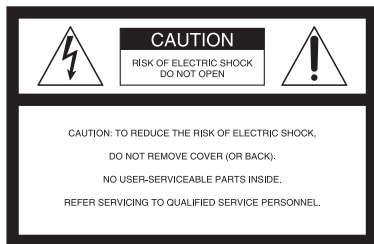

This symbol is intended to alert the user to the presence of uninsulated “dangerous voltage” within the product’s enclosure that may be of sufficient magnitude to constitute a risk of electric shock to persons.



This symbol is intended to alert the user to the presence of important operating and maintenance (servicing) instructions in the literature accompanying the appliance.

IMPORTANT SAFEGUARDS

For your protection, please read these safety instructions completely before operating the appliance, and keep this manual for future reference.

Carefully observe all warnings, precautions and instructions on the appliance, or the one described in the operating instructions and adhere to them.

Use

Power Sources

This set should be operated only from the type of power source indicated on the marking label. If you are not sure of the type of electrical power supplied to your home, consult your dealer or local power company. For those sets designed to operate from battery power, or other sources, refer to the operating instructions.

Polarization

This set may be equipped with a polarized ac power cord plug (a plug having one blade wider than the other).

This plug will fit into the power outlet only one way. This is a safety feature. If you are unable to insert the plug fully into the outlet, try reversing the plug. If the plug should still fail to fit, contact your electrician to have a suitable outlet installed. Do not defeat the safety purpose of the polarized plug by forcing it in.

Overloading

Do not overload wall outlets, extension cords or convenience receptacles beyond their capacity, since this can result in fire or electric shock.

Object and Liquid Entry

Never push objects of any kind into the set through openings as they may touch dangerous voltage points or short out parts that could result in a fire or electric shock. Never spill liquid of any kind on the set.

Attachments

Do not use attachments not recommended by the manufacturer, as they may cause hazards.

Cleaning

Unplug the set from the wall outlet before cleaning or polishing it. Do not use liquid cleaners or aerosol cleaners. Use a cloth lightly dampened with water for cleaning the exterior of the set.

Installation

Water and Moisture

Do not use power-line operated sets near water – for example, near a bathtub, washbowl, kitchen sink, or laundry tub, in a wet basement, or near a swimming pool, etc.

Power-Cord Protection

Route the power cord so that it is not likely to be walked on or pinched by items placed upon or against them, paying particular attention to the plugs, receptacles, and the point where the cord exits from the appliance.

Accessories

Do not place the set on an unstable cart, stand, tripod, bracket, or table. The set may fall, causing serious injury to a child or an adult, and serious damage to the set. Use only a cart, stand, tripod, bracket, or table recommended by the manufacturer.

Ventilation

The slots and openings in the cabinet are provided for necessary ventilation. To ensure reliable operation of the set, and to protect it from overheating, these slots and openings must never be blocked or covered.

- Never cover the slots and openings with a cloth or other materials.
- Never block the slots and openings by placing the set on a bed, sofa, rug, or other similar surface.
- Never place the set in a confined space, such as a bookcase, or built-in cabinet, unless proper ventilation is provided.
- Do not place the set near or over a radiator or heat register, or where it is exposed to direct sunlight.

Lightning

For added protection for this set during a lightning storm, or when it is left unattended and unused for

long periods of time, unplug it from the wall outlet and disconnect the antenna or cable system. This will prevent damage to the set due to lightning and power-line surges.

Service

Damage Requiring Service

Unplug the set from the wall outlet and refer servicing to qualified service personnel under the following conditions:

- When the power cord or plug is damaged or frayed.
- If liquid has been spilled or objects have fallen into the set.
- If the set has been exposed to rain or water.
- If the set has been subject to excessive shock by being dropped, or the cabinet has been damaged.
- If the set does not operate normally when following the operating instructions. Adjust only those controls that are specified in the operating instructions. Improper adjustment of other controls may result in damage and will often require extensive work by a qualified technician to restore the set to normal operation.
- When the set exhibits a distinct change in performance – this indicates a need for service.

Servicing

Do not attempt to service the set yourself as opening or removing covers may expose you to dangerous voltage or other hazards.

Refer all servicing to qualified service personnel.

Replacement parts

When replacement parts are required, be sure the service technician has used replacement parts specified by the manufacturer that have the same characteristics as the original parts.

Unauthorized substitutions may result in fire, electric shock, or other hazards.

Safety Check

Upon completion of any service or repairs to the set, ask the service technician to perform routine safety checks (as specified by the manufacturer) to determine that the set is in safe operating condition.

Read this first

Before operating the unit, please read this manual thoroughly, and retain it for future reference.

CAUTION

Replace the battery with the specified type only. Otherwise, fire or injury may result.

For customers in the U.S.A. and CANADA

RECYCLING LITHIUM-ION BATTERIES

Lithium-Ion batteries are recyclable. You can help preserve our environment by returning your used rechargeable batteries to the collection and recycling location nearest you.



For more information regarding recycling of rechargeable batteries, call toll free 1-800-822-8837, or visit <http://www.rbrbc.org/>

Caution: Do not handle damaged or leaking Lithium-Ion batteries.

Owner's Record

The model and serial numbers are located on the bottom. Record the serial number in the space provided below. Refer to these numbers whenever you call your Sony dealer regarding this product.

Model No. DCR-SR

Serial No.

Model No. AC-

Serial No.

For customers in the U.S.A.

If you have any questions about this product, you may call:
Sony Customer Information Center 1-800-222-SONY (7669).

The number below is for the FCC related matters only.

Regulatory Information

Declaration of Conformity

Trade Name: SONY

Model No.: DCR-SR40

Responsible Party: Sony Electronics Inc.

Address: 16530 Via Esprillo, San Diego, CA 92127 U.S.A

Telephone number: 858-942-2230

This device complies with Part 15 of the FCC Rules.

Operation is subject to the following two conditions:

(1) This device may not cause harmful interference, and (2) this device must accept any interference received, including interference that may cause undesired operation.

Declaration of Conformity

Trade Name: SONY

Model No.: DCR-SR60, DCR-SR80

Responsible Party: Sony Electronics Inc.

Address: 16530 Via Esprillo, San Diego, CA 92127 U.S.A

Telephone number: 858-942-2230

This device complies with Part 15 of the FCC Rules.

Operation is subject to the following two conditions:

(1) This device may not cause harmful interference, and (2) this device must accept any interference received, including interference that may cause undesired operation.

Notes

DCR-SR40, DCR-SR60 and DCR-SR80 are to be used with the Handycam Station Model DCRA-C162 and AC Adaptor Model AC-L25A/L25B.

CAUTION

You are cautioned that any changes or modifications not expressly approved in this manual could void your authority to operate this equipment.

Note

This equipment has been tested and found to comply with the limits for a Class B digital device, pursuant to Part 15 of the FCC Rules.

These limits are designed to provide reasonable protection against harmful interference in a residential installation. This equipment generates, uses, and can radiate radio frequency energy and, if not installed and used in accordance with the instructions, may cause harmful interference to radio communications.

However, there is no guarantee that interference will not occur in a particular installation. If this equipment does cause harmful interference to radio or television reception, which can be determined by turning the equipment off and on, the user is encouraged to try to correct the interference by one or more of the following measures:

- Reorient or relocate the receiving antenna.
- Increase the separation between the equipment and receiver.
- Connect the equipment into an outlet on a circuit different from that to which the receiver is connected.
- Consult the dealer or an experienced radio/TV technician for help.

The supplied interface cable must be used with the equipment in order to comply with the limits for a digital device pursuant to Subpart B of Part 15 of FCC Rules.

Battery pack

THIS DEVICE COMPLIES WITH PART 15 OF THE FCC RULES. OPERATION IS SUBJECT TO THE FOLLOWING TWO CONDITIONS:

(1) THIS DEVICE MAY NOT CAUSE HARMFUL INTERFERENCE, AND (2) THIS DEVICE MUST ACCEPT ANY INTERFERENCE RECEIVED, INCLUDING INTERFERENCE THAT MAY CAUSE UNDESIRE OPERATION.

For customers in CANADA

Battery pack

THIS CLASS B DIGITAL APPARATUS COMPLIES WITH CANADIAN ICES-003.

Notes on use

- The camcorder is not dust proofed, drip proofed or waterproofed. See “Precautions” (p.31).
- To prevent the hard disk from being broken or recorded images from being lost, do not remove the battery pack or AC Adaptor from the camcorder when either of the respective lamps of the POWER switch (p.12) or the ACCESS lamp* is on.

On recording

- Before starting to record, test the recording function to make sure the image and sound are recorded without any problems.
- Compensation for the contents of recordings cannot be provided, even if recording or playback is not possible due to a malfunction of the camcorder.
- TV color systems differ depending on the countries/regions. To view your recordings on a TV, you need a NTSC system-based TV.
- Television programs, films, video tapes, and other materials may be copyrighted. Unauthorized recording of such materials may be contrary to the copyright laws. You cannot dub copyright protected software on your camcorder.

Save all your recorded image data

- In the case of your image data being damaged, save all your recorded images. It is recommended that you save the image data on a DVD using your computer*. Also, you can save it using VCR/DVD device*.
- It is recommended that you save your image data periodically after recording.

Do not apply shock or vibration to your camcorder

- The hard disk of the camcorder may not be recognized, or recording or playback may not be possible.

On the drop sensor

- To protect the internal hard disk from the shock by dropping, the camcorder has the drop sensor function*. When a drop occurs, or under a non-gravity condition, the block noise to protect the camcorder may also be recorded. If the drop sensor catches a drop repeatedly, recording/playback may be stopped.

Note on operational temperatures

- When the temperature of the camcorder becomes extremely high or extremely low, you may not record or playback the camcorder to provide protection to the camcorder. In case of this, a message appears on the LCD screen (p.29).

Note on connecting the camcorder to a computer

- Do not format the hard disk of the camcorder using the computer. It may not operate correctly.

Note on using the camcorder in highlands

- Do not turn on the camcorder in a low-pressure area, where its altitude is more than 3,000 meters (9,800 feet). This may damage the hard disk drive of your camcorder.

Note on disposal/transfer

- If you perform [HDD FORMAT]* or formatting the camcorder, you may not delete data from the hard disk completely. When you transfer the camcorder, it is recommended that you perform [EMPTY HDD]* to make it difficult to recover your data. In addition to the above, when you dispose of the camcorder, it is recommended that you destroy the actual body of the camcorder. This may prevent data recovery on the hard disk of the camcorder.

On this manual

- The images of the LCD screen used on this manual are captured using a digital still camera, and thus may appear different from what you see.
- The illustrations used on this manual are based on the model DCR-SR80.
- The on-screen displays in each local language are used for illustrating the operating procedures. Change the screen language before using your camcorder if necessary.*
- The screenshots in this manual are from Windows XP. The scenes may vary depending on the operating system of the computer.

*Refer to “Handycam Handbook” (PDF).

Table of Contents

IMPORTANT SAFEGUARDS	2
Read this first	4
Notes on use	6

Getting Started

Step 1: Checking supplied items	8
Step 2: Charging the battery pack.....	10
Step 3: Turning the power on and setting the date and time.....	12
Step 4: Making setting adjustments before recording	13

Recording/Playback

Recording	14
Playback.....	15
Parts and functions used for the camcorder.....	16
Indicators displayed during recording/playback	18
Deleting images.....	20
Playing the image on a TV	20
Performing with a computer	21
Performing various functions - Setup	24

Troubleshooting

Troubleshooting.....	27
Warning indicators.....	29

Additional Information

Precautions	31
Specifications	33

Step 1: Checking supplied items

Make sure that you have following items supplied with your camcorder. The number in the parentheses indicates the number of that item supplied.

AC Adaptor (1) (p.10)

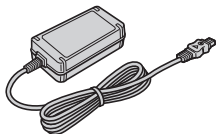

Power cord (1) (p.10)

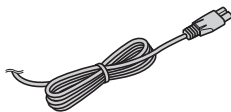

Handycam Station (1) (p.10)

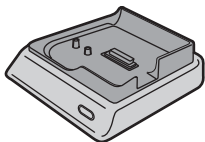

A/V connecting cable (1) (p.20)



USB cable (1)

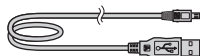

Wireless Remote Commander (1)
(DCR-SR60/SR80)

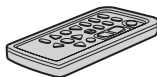

A button-type lithium battery is already installed.

Rechargeable battery pack
NP-FP50 (1) (p.11)

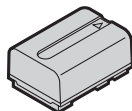

Lens Cap (1) (p.12) (DCR-SR40)

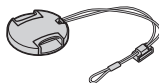

To attach the lens cap

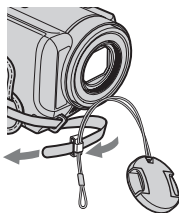

Thread the grip belt through the lens cap ring.

CD-ROM (1) (p.21)

- "ImageMixer for HDD Camcorder" (Software)
- "Handycam Handbook" (PDF)

"Operating Guide" (This manual) (1)

On the Remote Commander (DCR-SR60/SR80)

Using the Remote Commander for the first time

Remove the insulation sheet before using the Remote Commander.

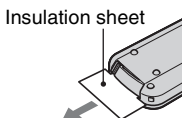

To change the battery of the Remote Commander

- ① While pressing on the tab, inset your fingernail into the slit to pull out the battery case.
- ② Place a new battery with the + side facing up.
- ③ Insert the battery case back into the Remote Commander until it clicks.

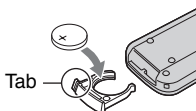

WARNING

Battery may explode if mistreated. Do not recharge, disassemble or dispose of in fire.

- A button-type lithium battery (CR2025) is used in the Remote Commander. Do not use batteries other than the CR2025.
- When the lithium battery becomes weak, the operating distance of the Remote Commander may shorten, or the Remote Commander may not function properly. In this case, replace the battery with a Sony CR2025 lithium battery. Use of another battery may present a risk of fire or explosion.

Step 2: Charging the battery pack

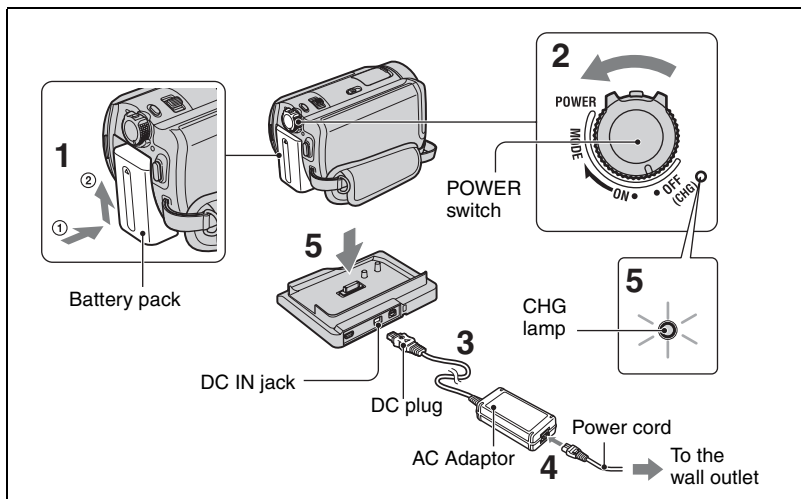

You can charge the battery after attaching the “InfoLITHIUM” battery pack (P series) to your camcorder.

1 Slide the battery pack in the direction of the arrow until it clicks.

2 Slide the POWER switch in the direction of the arrow to set it to OFF (CHG) (The default setting).

3 Connect the AC Adaptor to the DC IN jack on the Handycam Station. Be sure that the ▲ mark on the DC plug is facing up.

4 Connect the power cord to the AC Adaptor and the wall outlet.

5 Set the camcorder onto the Handycam Station securely.

The CHG (charge) lamp lights up and charging starts. The CHG (charge) lamp turns off when the battery pack is fully charged. Remove the camcorder from the Handycam Station.

To remove the battery pack

Slide the POWER switch to OFF (CHG). Slide the BATT (battery) release lever and remove the battery pack.

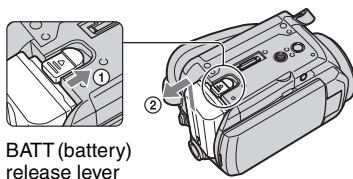

- When you remove the battery pack, make sure that none of the respective lamps of the POWER switch (p.12) is on.

To charge the battery pack using only the AC Adaptor

Slide the POWER switch up to OFF (CHG), then connect the AC Adaptor directly to the DC IN jack on the camcorder.

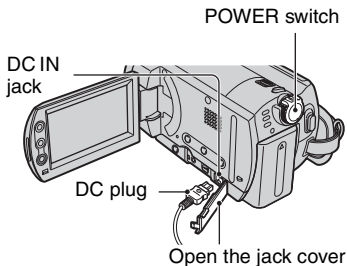

Available running time for the supplied battery pack NP-FP50

Charging time:

Approximate time (min.) required when you fully charge a completely exhausted battery pack.

Recording/Playback time:

Approximate time (min.) available when you use a fully charged battery pack.

(Unit:min.)

	DCR-SR40	DCR-SR60/ SR80
Charging time	125	125
Recording time* ¹		
Continuous recording time	125	100* ² 105* ³
Typical recording time* ⁴	65	55* ² 55* ³
Playback time	140	115* ²

*¹ When [REC MODE] is set to [HQ].

*² When the LCD backlight turns on.

*³ When the LCD backlight turns off.

*⁴ Typical recording time shows the time when you repeat recording start/stop, turning the power on/off and zooming.

On the battery pack

- Before changing the battery pack, slide the POWER switch to OFF (CHG).
- The power will not be supplied from the battery as long as the AC Adaptor is connected to the DC IN jack of your camcorder, even when the power cord is removed from the wall outlet.

On the charging/recording/playback time

- Times measured with the camcorder at 25°C (77°F). (10-30°C (50-86°F) is recommended.)
- Available recording and playback time will be shorter when you use your camcorder in low temperatures.
- The available recording and playback time will be shorter depending on the conditions under which you use your camcorder.

On the AC Adaptor

- Connect the AC Adaptor to an easily accessible wall outlet close by. If any trouble occurs while using the adaptor, immediately shut off the power by removing the plug from the wall outlet.
- Do not use the AC Adaptor placed in a narrow space, such as between a wall and furniture.
- Do not short-circuit the DC plug of the AC Adaptor or battery terminal with any metallic objects. This may cause a malfunction.

PRECAUTION

- Even if your camcorder is turned off, AC power (house current) is still supplied to it while connected to the wall outlet via the AC Adaptor.

Power supply

You can use your camcorder in any countries/regions using the AC Adaptor supplied with your camcorder within the AC 100 V to 240 V, 50/60 Hz range.

Use a commercially available AC plug adaptor [a], if necessary, depending on the design of the wall outlet [b].



Step 3: Turning the power on and setting the date and time

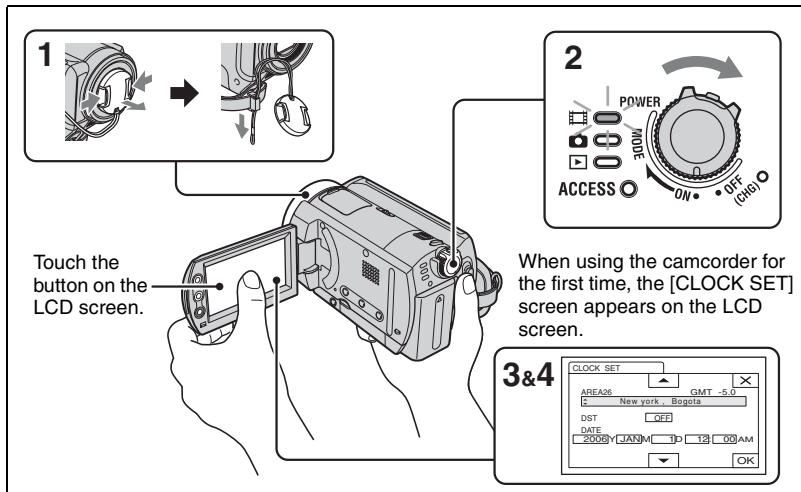

1 Remove the lens cap by pressing both tabs on the sides of the cap. Pull the lens cap sliding down until stopped by the grip belt (DCR-SR40).

2 Turn on the power by sliding the **POWER** switch in the direction of the arrow while pressing the green button in the center.

When you record or play back an image, slide the **POWER** switch in the direction of the arrow repeatedly until the respective lamp lights up.

(Movie): To record movies

(Still): To record still images

(PLAY/EDIT): To play back images on your camcorder, or to edit/delete them

3 Select the desired geographical area with / , then touch .

4 Set [DST], [Y] (year), [M] (month), [D] (day), hour and minute.

The clock starts.

- The recording date and time are not displayed during recording but are automatically recorded onto the hard disk and displayed during playback (see “Handycam Handbook” (PDF)).
- Instead of [DST], [SUMMERTIME] is displayed for some models.

When resetting the date and time

You can set the desired date and time by touching [P-MENU] → [SETUP] → TIME/LANGU. → [CLOCK SET] (p.24).

Step 4: Making setting adjustments before recording

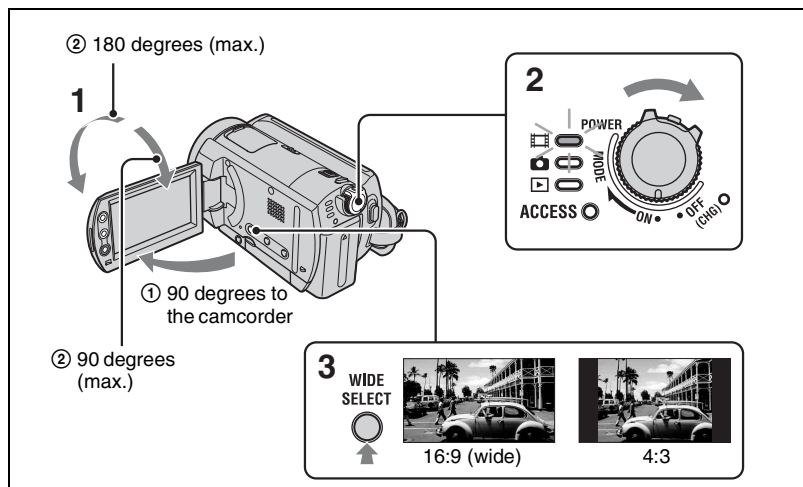

1 Open the LCD screen 90 degrees to the camcorder (①), then rotate it to the best angle to record or play (②).

2 Slide the POWER switch in the direction of the arrow repeatedly until the respective lamp lights up.

 (Movie): To record movies

 (Still): To record still images

• When you turn on  (Still), the screen aspect ratio is changed to 4:3 automatically.

3 Press WIDE SELECT repeatedly to select the desired screen aspect ratio (DCR-SR60/SR80).

4 Fasten the grip belt and hold your camcorder correctly.

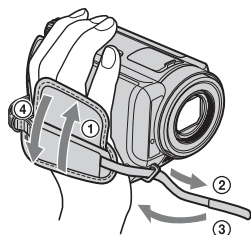

Recording

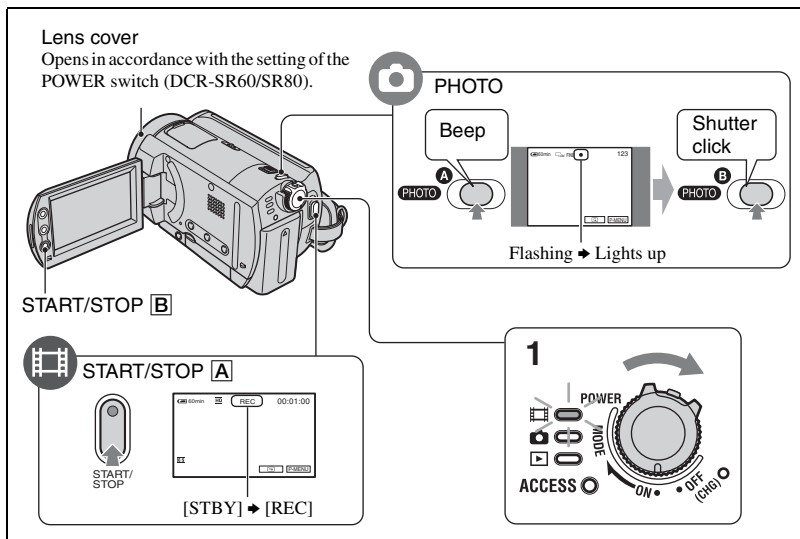

1 Slide the **POWER** switch in the direction of the arrow repeatedly until the respective lamp lights up.

Press the green button only when the **POWER** switch is in the **OFF (CHG)** position.

2 Start recording.

Movies

Press **START/STOP** **A** (or **B**).

To stop recording, press **START/STOP** again.

Still Images

Press **PHOTO** lightly to adjust the **focus A**, then press it fully **B**.

A shutter sound is heard. When **||||** disappears, the image has been recorded.

- If the **ACCESS** lamp is on after recording is finished, it means data is still being written onto the hard disk. Do not apply shock or vibration to your camcorder, and do not remove the battery pack or AC Adaptor.
- You cannot record movies and still images at the same time.
- The maximum continuous recordable time is approximately 13 hours.

Playback

1 Slide the POWER switch repeatedly to light up the (PLAY/EDIT) lamp.

The VISUAL INDEX screen appears on the LCD screen.

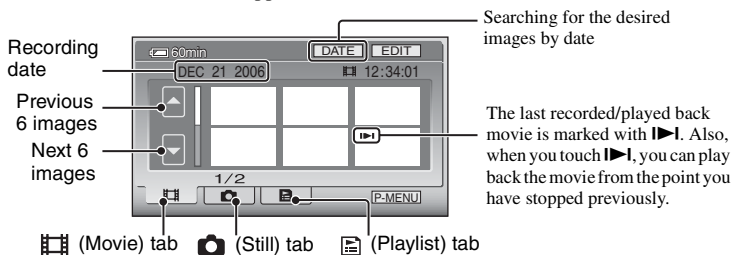

2 Start playback.

Movies

Touch  (Movie) tab and the movie to be played back.

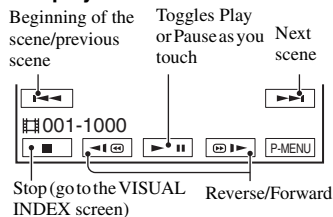



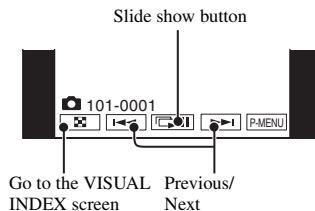

When playback from the selected movie reaches the last movie, the screen returns to the VISUAL INDEX screen.

Still Images



Touch  (Still) tab and the still image to be played back.



- Touch  /  during pause to play back movie slowly.
- One touch of  /  makes the reverse/fast forward approximately five times faster, two touches make it approximately 10 times faster, three touches make it approximately 30 times faster, four touches make it approximately 60 times faster.

- The ACCESS lamp either lights or flashes when image data is read from the hard disk drive of the camcorder.

To adjust the volume

Touch [P-MENU] → [VOLUME], then adjust it with  / .

- If you cannot find [VOLUME] in [P-MENU], touch [SETUP] (p.24).

Parts and functions used for the camcorder

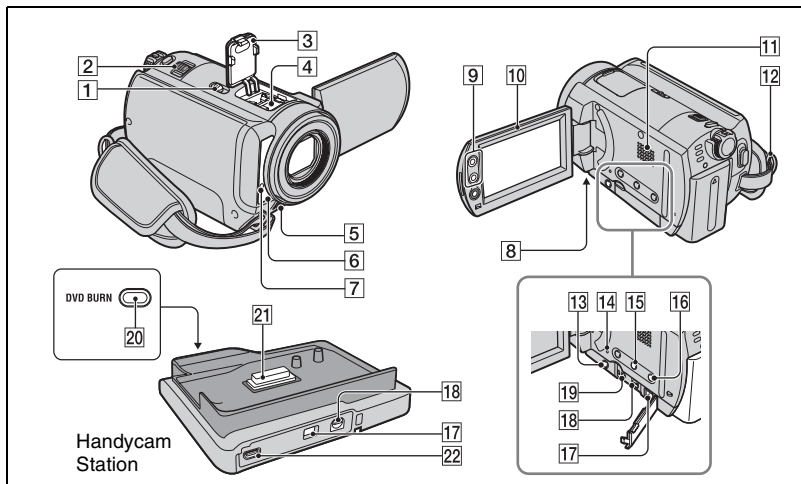

Recording

1 NIGHTSHOT PLUS switch

To record in dark places, set the NIGHTSHOT PLUS switch to ON. ( and ["NIGHTSHOT PLUS"] appear.)

2 Power zoom lever

To use zoom, move the power zoom lever. Move the power zoom lever slightly for a slower zoom. Move it further for a faster zoom.

W:Wide

Wider range of view

T:Telephoto

Close view



5 Built-in stereo microphone

Records sound.

6 Remote sensor (DCR-SR60/SR80)

Receive the signal from the Remote Commander.

7 Recording lamp (DCR-SR60/SR80)

The recording lamp lights up red during recording. The lamp flashes when the remaining capacity for the battery or the hard disk of the camcorder is running low.

8 Tripod receptacle (Bottom surface)

To use a tripod, attach the tripod (optional: the length of the screw must be less than 5.5 mm) to the tripod receptacle using a tripod screw.

9 Zoom buttons

Press for zooming in/out.

10 LCD screen

To record in mirror mode, open the LCD screen 90 degrees to the camcorder (①), then rotate it 180 degrees to the lens side (②).

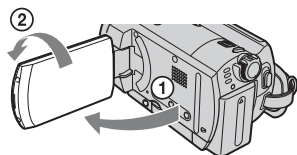

12 Shoulder belt hook

To attach the shoulder belt, attach the shoulder belt (optional) with your camcorder to the shoulder belt hook.

13 BACK LIGHT button

To adjust the exposure for backlit subjects, press BACK LIGHT to display . To cancel the back light function, press BACK LIGHT again.

14 RESET button

To initialize the settings (Reset), press RESET to initialize all the settings, including settings for date and time.

15 DISP/BATT INFO button

You can change the settings for the screen display settings or check the remaining battery power.

16 EASY button

By pressing the EASY button, most of the settings on the camcorder will be automatically operated. In this way, you can use the camcorder with simple operation (Easy Handycam operation). During Easy Handycam operation, you may not use some of the buttons on the camcorder.

Playback**2 Power zoom lever****9 Zoom buttons**

You can magnify images from about 1.1 to 5 times the original size (Playback zoom).

- ① Play back the image you want to magnify.
- ② Magnify the image with T (Telephoto). A frame appears on the LCD screen.
- ③ Touch the portion you want to display in the center of the LCD screen.
- ④ Adjust the magnification with W (Wide angle)/T (Telephoto).

To cancel, touch [END].

11 Speaker

Sound comes out from the speaker while playing back.

16 EASY button

Refer to the instructions on EASY button in "Recording".

Connecting to other devices**17 18 19 Open the jack cover.****3 Shoe cover (DCR-SR60/SR80)**

Open when using Active Interface Shoe.

4 Active Interface Shoe  (DCR-SR60/SR80)

The Active Interface Shoe supplies power to optional accessories such as a video light, a flash, or a microphone. The accessory can be turned on or off as you operate the POWER switch on your camcorder.

17 DC IN jack

Connect to the DC plug of the AC Adaptor.

18 A/V (audio/video) jack

Connect with the A/V connecting cable.

19 REMOTE jack (DCR-SR60/SR80)

Connect other optional accessories.

20 DVD BURN button

Create a DVD by connecting the camcorder to a computer.

21 Interface connector

Connect with the camcorder and the Handycam Station.

22  (USB) jack

Connect with the USB cable.

Indicators displayed during recording/playback

Recording movies

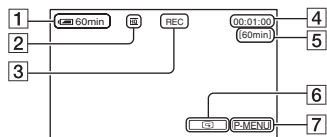

- 1 Remaining battery (approx.)
- 2 Recording mode (HQ / SP / LP)
- 3 Recording status ([STBY] (standby) / [REC] (recording))
- 4 Counter (hour: minute: second)
- 5 Remaining recordable time of movies
- 6 Review button
- 7 Personal Menu button

Recording still images

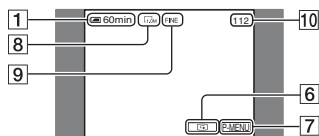

- 8 Image size (DCR-SR60/SR80)
- 9 Quality ([FINE] / [STD])
- 10 Number of recordable still images

Viewing movies

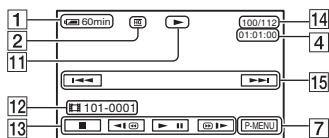

- 11 Playback mode
- 12 Recording folders/files
- 13 Video operation buttons
- 14 Number of played back movies/Total number of recorded movies
- 15 Previous/Next button

Viewing still images

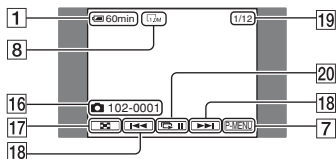

- 16 Recording folders/files
- 17 VISUAL INDEX button
- 18 Previous/Next button
- 19 Number of played back still images/Total number of recorded still images
- 20 Slide show button

Indicators on the LCD screen

When you can change the setup items, or during recording or playback, following indicators are displayed.

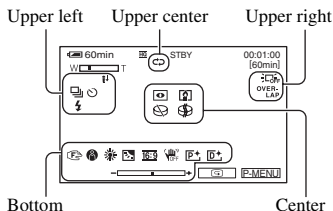

Upper left

Indicator	Meaning
	Self-timer recording
BRK	Continuous photo recording / Bracket recording
	Flash light
	MICREF LEVEL low

Upper center

Indicator	Meaning
	Repeat of Slide show

Upper right

Indicator	Meaning
WHITE FADER OVER-LAP BLACK FADER WIPE	Fader
	LCD backlight off
	Drop sensor off
	Drop sensor

Center

Indicator	Meaning
	NightShot plus
	Super NightShot plus
	Color Slow Shutter
	PictBridge connecting
	Warning



Bottom

Indicator	Meaning
	Picture effect
	Digital effect
	Manual focus
	PROGRAM AE
	Backlight
	White balance
	WIDE SELECT
	SteadyShot off
	Flexible spot meter / Exposure

DATA CODE while recording

The recording date and time are recorded automatically. They are not displayed while recording. However, you can check them as [DATA CODE] during playback.

Deleting images

1 Select the  (Movie) tab or the  (Still) tab on the VISUAL INDEX screen.

2 Touch [EDIT] → [DELETE], then select the image to be deleted.

The selected image is marked with ✓.

3 Touch  → [YES].

To delete all movies or still images at once

Touch [EDIT] → [DELETE ALL] in step 2, then follow the on-screen instructions.



Deleting images by date

① Touch [DATE] on the VISUAL INDEX screen, then touch the Previous/Next Date button to select the date of the desired image.

② Touch  → [EDIT] → [DELETE DATE] → [YES].

Deleting the last scene

You can check the last recorded movie/still image. Also, you can delete the checked images.

① Slide the POWER switch to light up the  (Movie) or  (Still) lamp, then touch .

② Touch  → [YES].

Playing the image on a TV

Connect your camcorder to the input jack of TV or VCR using A/V connecting cable **1** (supplied) or A/V connecting cable with S VIDEO **2** (optional). For details, see “Handycam Handbook” (PDF).

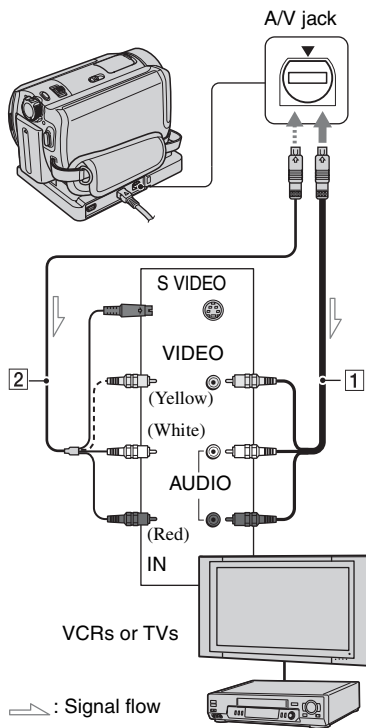

Performing with a computer

In the supplied CD-ROM, the following items are contained:

- “ImageMixer for HDD Camcorder” (Software)
Software to help you view/edit/create DVD on a computer connected to the camcorder.
- “Handycam Handbook” (PDF)
Handbook to introduce how to use the camcorder.

Install the above on a computer by following the steps below.

Viewing “Handycam Handbook” (PDF)

To view “Handycam Handbook,” you need to install Adobe Reader on your computer.

■ For Windows user

- ① Turn on the computer.
- ② Place the CD-ROM (supplied) on the disc drive of your computer.
The select screen for installation appears.



- ③ Click [Handycam Handbook].
The installation screen for “Handycam Handbook” appears.

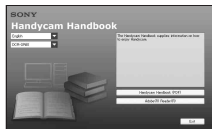

- ④ Select desired language and select the model name of your Handycam.
- ⑤ Click [Handycam Handbook (PDF)].
Installation starts. When the installation is completed, the short-cut icon of “Handycam Handbook” appears on the desktop of your computer.

- The model name of your Handycam is printed on its bottom surface.

- ⑥ Click [Exit] → [Exit], then remove the CD-ROM from the disc drive of your computer.

■ For Macintosh user

- ① Turn on the computer.
- ② Place the CD-ROM (supplied) on the disc drive of your computer.
- ③ Open the [Handbook] folder in the CD-ROM, double-click the [US] folder and then drag-and-drop the “Handbook.pdf” on the computer.

After having the software installed, double-click “Handbook.pdf”, you can view the handbook.

Installing the supplied software

The supplied software “ImageMixer for HDD Camcorder” is not compatible with a Macintosh.

To use the camcorder connecting with a Macintosh, apply the compliant software introduced on the following website.

- The system requirements for Macintosh are also shown on the website.

Pixela home page:

<http://www.pixela.co.jp/oem/sony/e/>

Compliant Software:

- Capty MPEG Edit EX (Video editing software)
- Capty DVD/VCD 2 (DVD authoring software)

■ System requirements

When using the supplied software, you need the following system requirements below.

OS : Windows 2000 Professional (Service Pack 3 or later) / Windows XP Home Edition/Windows XP Professional

- Standard installation is required. Operation is not assured if the above OS has been upgraded.

CPU : Intel Pentium III 800 MHz or faster (Pentium 4 1.7 GHz or faster recommended), or the equivalent CPU

Application : DirectX 9.0c or later (This product is based on DirectX technology. It is necessary to have DirectX installed.)

Sound system : 16 bit stereo sound card and stereo speakers

Memory : For Windows 2000 Professional: 128 MB or more (256 MB or more recommended)

For Windows XP Home Edition / Professional Edition: 256 MB or more (512 MB or more recommended)

Hard Disk : Available memory required for installation: 300 MB or more

Available free hard disk space for operations required: 14 GB or more (for dual layer DVD system, 28 GB or more required)

- When copying images to a computer, more available disk space required for saving image data than shown above.

Display : 4MB VRAM video card, Minimum 1024 × 768 dots, High color (16 bit color, 65 000 colors). This product will not operate correctly at less than 800 × 600 dots, and 256 colors or less.

USB port : As standard equipment (USB 2.0 recommended)

- The camcorder is compatible with Hi-Speed USB (USB2.0). You can transfer data at a faster rate using a computer compatible with Hi-Speed USB (USB2.0). When you connect a USB interface not compatible with Hi-Speed USB (USB2.0), the data transfer ratio will be that of USB1.1 (USB full speed).

Disc Drive : A DVD writable drive

- Operations are not guaranteed on any computers fulfilling the above system requirements.

■ Installing software

You need to install the software to your Windows computer. The installation is only required once.

- ① Confirm that your camcorder is not connected to the computer.
- ② Turn on the computer.
 - Log on as Administrators for installation.
 - Close all the applications running on the computer before installing the software.
- ③ Place the CD-ROM (supplied) on the disc drive of your computer. The select screen for installation appears.
- ④ Click [ImageMixer for HDD Camcorder]. The installation screen appears.



If the screen does not appear, follow the steps below.

- ① Click [start], then click [My Computer] (For Windows 2000, double-click [My Computer] on the desktop.)
- ② Double-click [CAMCORDERSOFT (E:)] (CD-ROM)*

* Drive names (such as (E:)) vary depending on the computer.

- ③ Double-click [install.exe].
- ⑤ Click [Install].
- ⑥ Select the language for the application to be installed, then click [Next].
- ⑦ Click [Next].
- ⑧ Read [License Agreement], check [I accept the terms of the license agreement] when you agree, then click [Next].



- ⑨ Select a folder to save the software, then click [Next].

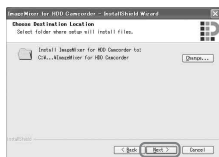

- ⑩ Select [NTSC], then click [Next].



- ⑪ Click [Install] on the [Ready to Install the Program] screen.



The installation for “ImageMixer for HDD Camcorder” starts.

- ⑫ If the [Installing Microsoft® DirectX®] screen is displayed, follow the steps below to install DirectX 9.0c. If not, skip to step ⑬.

- ① Read [License Agreement], then click [Next].



- ② Click [Next].

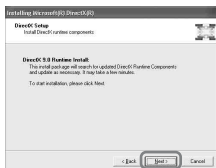

- ③ Click [Finish].



- ⑬ Make sure [Yes, I want to restart my computer now.] is checked, then click [Finish].



The computer turns off once, then starts up again automatically (Restart).

When you complete the installation, the shortcut icons for [ImageMixer for HDD Camcorder] and [ImageMixer destination folder] appear on the desktop of your computer.



- ⑭ Remove the CD-ROM from the disc drive of your computer.

Performing various functions - Setup

- 1 Slide the **POWER** switch in the direction of the arrow repeatedly until the respective lamp lights up.

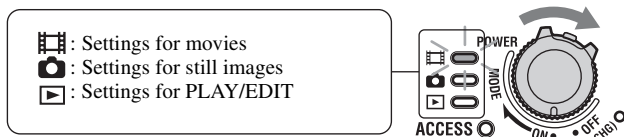

- 2 Touch the LCD screen to select the setup item.

Unavailable items will be grayed out.

■ To use the short-cuts of Personal Menu

On Personal Menu, short-cuts for frequently used setup items are added.

- For details, see “Handycam Handbook” (PDF).

- ① Touch **P-MENU**.

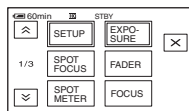

- ② Touch the desired setup item.
If the desired setup item is not displayed on the screen, touch / until it is displayed.
- ③ Select the desired setting, then touch **OK**.

■ To change the setup items

You can customize setup items that are not added to Personal Menu.

- ① Touch **P-MENU** → **[SETUP]**.
- ② Select the desired setup item.
Touch / to select the item, then touch **OK**. (The process in step ③ is the same as that in step ②.)
- ③ Select the desired item.
 - You can also touch the item directly to select it.
- ④ Customize the item.
After finishing the settings, touch **OK** → **X** (close) to hide the setup screen.
If you decide not to change the settings, touch to return to the previous screen.



■ To change the setup items during Easy Handycam operation

P-MENU does not appear during Easy Handycam operation. Touch **[SETUP]**, available setup items appear.



Setup items

Available setup items vary depending on the operating mode. **Unavailable items will be grayed out on the LCD screen of the camcorder.** For details, refer to “Handycam Handbook” (PDF).

CAMERA SET

PROGRAM AE:	Records images effectively in various situations.
SPOT METER:	Adjusts and fix the exposure to a subject.
EXPOSURE:	Fixes the brightness of an image.
WHITE BAL.:	Adjusts the color balance to the brightness of the recording environment.
AUTO SHUTTER:	Automatically activates the electronic shutter to adjust the shutter speed.
SPOT FOCUS:	Selects and adjusts the focal point to aim it to at a subject not located in the center of the screen.
FOCUS:	Adjusts the settings to have focused on a subject.
FLASH SET *1:	Adjusts various settings for using an external flash.
SUPER NSPLUS:	Records an image in a higher sensitivity than NightShot plus.
NS LIGHT:	Records clearer images with the light which emits infrared light while using NightShot plus.
COLOR SLOW S:	Records an image brighter in color even in dark places.
 SELF-TIMER:	Selects whether to set the self-timer for shooting a still image.
 SELF-TIMER:	Selects whether to set the self-timer for recording a movie.
DIGITAL ZOOM:	Selects the zoom level using digital zoom.
WIDE SELECT *2:	Sets the screen aspect ratio matching a TV screen.
STEADYSHOT:	Prevents an image from being blurred.

STILL SET

 BURST *1:	Records several still images one after another.
 QUALITY:	Selects the quality for recording a still image.
 IMAGE SIZE *1:	Selects the size for recording a still image.



PICT.APPLI.

FADER:	Selects whether to fade in/out adding various effects.
D.EFFECT:	Records additional digital effects.
PICT.EFFECT:	Records adding special picture effects.
REC CTRL *1:	Displays operating buttons when recording an image saved on other device on the camcorder.
USB SELECT *3:	Selects a function for connecting the camcorder with a computer/printer.
DEMO MODE:	Displays the demonstration of the functions on the camcorder.

HDD SET

HDD FORMAT:	Initializes the hard disk drive.
HDD INFO:	Displays free hard disk space of the hard disk drive.
DROP SENSOR:	Deactivates the camcorder when detecting a drop for data protection.
EMPTY HDD:	Prevents data on the hard disk drive from being recovered. – Displays this item only when the camcorder is turned on by pressing DISP/ BATT INFO, with the AC Adaptor connected to the camcorder.

STANDARD SET

REC MODE:	Selects image quality of a movie.
VOLUME:	Adjusts the volume during a movie playback.
MULTI-SOUND:	Selects whether to play audio with dual sound or stereo sound.
MICREF LEVEL * ¹ :	Selects the microphone level for recording sound.
LCD SET:	Sets various settings for the LCD screen.
TV TYPE * ¹ :	Selects the aspect ratio of an image output from the camcorder.
USB SPEED:	Selects the speed for data transfer via USB connection.
DATA CODE:	Displays date and time and camera data during playback.
 DISPLAY:	Selects a number of thumbnails on the VISUAL INDEX display.
 REMAINING:	Selects whether to display the remaining hard disk free space for a movie recording.
REMOTE CTRL * ¹ :	Select whether to receive remote control signals or not.
REC LAMP * ¹ :	Selects whether to light up the REC lamp on the front panel of the camcorder.
BEEP:	Selects whether to emit a beep during operation.
DISP OUTPUT:	Selects whether to show a display such as a counter on the LCD screen or on a TV.
SETUP ROTATE:	Select whether to scroll up or down the setup items.
A.SHUT OFF:	Automatically turns off the camcorder when it is not operated.
CALIBRATION:	Adjusts the sensibility for the touch panel.

TIME/LANGU.

CLOCK SET:	Select date and time.
AREA SET:	Adjust a time difference without stopping the clock abroad.
DST SET/ SUMMERTIME:	Selects whether to set summer time.
LANGUAGE:	Selects the language to be used on the LCD screen.

*¹ DCR-SR60/SR80

*² DCR-SR40

*³ [USB SELECT] appears automatically when your camcorder is connected to a computer or other device with the USB cable.

Troubleshooting

If you run into any problems using your camcorder, refer to the following table to troubleshoot them. If your problem persists, remove the power source and contact with your Sony dealer.

Note before sending your camcorder for repair

- Your camcorder may be required to initialize or change the current hard disk of the camcorder, depending on the problem. In the event of this, the data stored on the hard disk will be deleted. Be sure to save (backup) the data on the hard disk (see “Handycam Handbook” (PDF)) on the other media before sending your camcorder to repair. We cannot guarantee any loss of your hard disk data.
- During repair, we may check a minimum amount of data stored on the hard disk in order to improve the condition. However, your Sony dealer will neither copy nor save your data.

The camcorder does not operate even when the power is set to on.

- Remove the AC Adaptor from the wall outlet or remove the battery pack, then reconnect it after about one minute. If the functions still do not work, press the RESET button (p.17) using a sharp-pointed object. (If you press the RESET button, all settings are reset, except the Personal Menu items.)
- The temperature of your camcorder is extremely high. Turn off your camcorder and leave it for a while in a cool place.
- The temperature of your camcorder is extremely low. With POWER switch turned on, leave the camcorder for a while. If you still cannot operate the camcorder, turn it off, taking it to a warm place. Leave the camcorder there for a while, then turn on the camcorder.

Buttons do not work.

- During Easy Handycam operation, available buttons are limited. Cancel Easy Handycam operation. For details on Easy Handycam operation, refer to “Handycam Handbook” (PDF).



The power does not turn on.

- The battery pack is not attached to the camcorder. Attach a charged battery pack to the camcorder (p.10).
- The battery pack is discharged or running low. Charge the battery pack (p.10).
- The plug of the AC Adaptor has been removed from the wall outlet. Connect it to the wall outlet (p.10).
- Set the camcorder onto the Handycam Station securely (p.10).

The power abruptly turns off.

- When approximately five minutes have elapsed while you do not operate your camcorder, the camcorder is automatically turned off (A.SHUT OFF). Change the setting of [A.SHUT OFF], or turn on the power again, or use the AC Adaptor.
- The battery pack is discharged or running low. Charge the battery pack (p.10).

Pressing START/STOP or PHOTO does not record movies/still images.

- Slide the POWER switch to light up the  (Movie) or the  (Still) lamp (p.12).
- Your camcorder is recording the image you have just shot on the hard disk of the camcorder. You cannot press PHOTO while [CAPTURE] or  appears on the LCD screen.
- The hard disk of the camcorder is full. Delete unnecessary images. Or perform [HDD FORMAT].
- The temperature of your camcorder is extremely high. Turn off your camcorder and leave it for a while in a cool place.
- The temperature of your camcorder is extremely low. With POWER switch turned on, leave the camcorder for a while. If you still cannot operate the camcorder, turn it off, taking it to a warm place. Leave the camcorder there for a while, then turn on the camcorder.

The recording stops.

- The temperature of your camcorder is extremely high. Turn off your camcorder and leave it for a while in a cool place.
- The temperature of your camcorder is extremely low. Turn off the camcorder and take it to a warm place. Leave the camcorder there for a while, then turn on the camcorder.
- The maximum continuous recordable time is approximately 13 hours.

Setup items are grayed out.

- You cannot select grayed out items in the current situation.

The beep sounds for five seconds.

- The temperature of your camcorder is extremely high. Turn off your camcorder and leave it for a while in a cool place.
- Some problems have occurred in your camcorder. Turn off and on, then operate your camcorder again.

Warning indicators

Self-diagnosis display/Warning indicators

If indicators appear on the LCD screen, check the following.

You can solve some of the symptoms by yourself. If your problem persists even after you have tried a couple of times, contact your Sony dealer or local authorized Sony service facility.

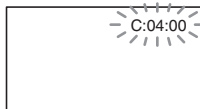

C:(or E:) □□:□□ (Self-diagnosis display)

C:04:□□

- The battery pack is not an “InfoLITHIUM” battery pack. Use an “InfoLITHIUM” battery pack (p.10).
- Connect the DC plug of the AC Adaptor to the DC IN jack of the Handycam Station or your camcorder securely (p.10).

C:13:□□ / C:32:□□

- Remove the power source. Reconnect it and operate your camcorder again.

E:20:□□ / E:31:□□ / E:40:□□ / E:61:□□ / E:62:□□ / E:91:□□ / E:94:□□

- A malfunction that you cannot service has occurred. Contact your Sony dealer or local authorized Sony service facility. Inform them of the 5-digit code, which starts from “E”.

100-0001 (Warning indicator pertaining to files)

Slow flashing

- The file is damaged.
- The file is unreadable.

(Warning on the hard disk of the camcorder)*

Fast flashing

- An error may have occurred with the hard disk drive in your camcorder.

(Warning on the hard disk of the camcorder)*

Fast flashing

- The hard disk of the camcorder is fully recorded.
- An error may have occurred with the hard disk drive in your camcorder.

(Battery level warning)

Slow flashing

- The battery pack is nearly used up.
- Depending on the operating environment or battery conditions,  may flash, even if there are approximately 20 minutes remaining.

(High temperature warning)

Slow flashing

- The temperature of your camcorder is getting higher. Turn off your camcorder and leave it for a while in a cool place.

Fast flashing*

- The temperature of your camcorder is extremely high. Turn off your camcorder and leave it for a while in a cool place.

(Low temperature warning)

Fast flashing*

- The temperature of your camcorder is extremely low. Make the camcorder warm.

 **(Warning indicator pertaining to camera-shake warning)***

- The amount of lights is not sufficient, so camera-shake easily occurs. Use the flash.
- The camcorder is unsteady, so camera-shake easily occurs. Hold the camcorder steady with both hands and record the image. However, note that the camera-shake warning indicator does not disappear.

* You hear a melody when the warning indicators appear on the screen.

Precautions

On use and care

- Do not use or store the camcorder and accessories in the following locations.
 - Anywhere extremely hot or cold or humid places. Never leave them exposed to temperatures above 60°C (140°F), such as under direct sunlight, near heaters or in a car parked in the sun. They may malfunction or become deformed.
 - Near strong magnetic fields or mechanical vibration. The camcorder may malfunction.
 - Near strong radio waves or radiation. The camcorder may not record properly.
 - Near AM receivers and video equipment. Noise may occur.
 - On a sandy beach or anywhere dusty. If sand or dust gets in your camcorder, it may malfunction. Sometimes this malfunction cannot be repaired.
 - Near windows or outdoors, where the LCD screen or the lens may be exposed to direct sunlight. This damages the inside of the LCD screen.
- Operate your camcorder on DC 7.2 V (battery pack) or DC 8.4 V (AC Adaptor).
- For DC or AC operation, use the accessories recommended in this instruction manual.
- Do not let your camcorder get wet, for example, from rain or sea water. If your camcorder gets wet, it may malfunction. Sometimes this malfunction cannot be repaired.
- If any solid object or liquid gets inside the casing, unplug your camcorder and have it checked by a Sony dealer before operating it any further.
- Avoid rough handling, disassembling, modifying, physical shock, or impact such as hammering, dropping or stepping on the product. Be particularly careful of the lens.
- Keep the POWER switch setting to OFF (CHG) when you are not using your camcorder.
- Do not wrap your camcorder with a towel, for example, and operate it. Doing so might cause heat to build up inside.
- When removing the power cord, pull it by the plug and not the cord.
- Do not damage the power cord such as by placing anything heavy on it.
- Keep metal contacts clean.

- Keep the Remote Commander and button-type battery out of children's reach. If the battery is accidentally swallowed, consult with a doctor immediately (DCR-SR60/SR80).
- If the battery electrolytic liquid has leaked,
 - consult with your local authorized Sony service facility.
 - wash off any liquid that may have contacted your skin.
 - if any liquid gets in your eyes, wash with plenty of water and consult with a doctor.

■ When not using your camcorder for a long time

- Occasionally turn it on and let it run such as by playing back images or recording for about three minutes.
- Use up the battery pack completely before storing it.

On the LCD screen

- Do not exert excessive pressure on the LCD screen. Blurs appear and it may cause a malfunction of your camcorder.
- If your camcorder is used in a cold place, a residual image may appear on the LCD screen. This is not a malfunction.
- While you are using your camcorder, the back of the LCD screen may heat up. This is not a malfunction.

■ To clean the LCD screen

If fingerprints or dust make the LCD screen dirty, use the cleaning cloth (optional) to clean the LCD screen. When you use the LCD Cleaning Kit (optional), do not apply the cleaning liquid directly to the LCD screen. Use cleaning paper moistened with the liquid.

On handling the casing

- If the casing is soiled, clean the camcorder body with a soft cloth lightly moistened with water, and then wipe the casing with a dry soft cloth.
- Avoid the followings to prevent damage to the finish.
 - Using chemicals such as thinner, benzine, alcohol, chemical cloths, repellent and insecticide and sunscreen.
 - Handling with above substances on your hands.
 - Leaving the casing in contact with rubber or vinyl objects for a long period of time.

Care and storage of the camera lens

- Wipe the surface of the lens clean with a soft cloth in the following instances:
 - when there are fingerprints on the lens surface.
 - in hot or humid locations
 - when the lens is exposed to salty air such as at the seaside.
- Store the lens in a well-ventilated location subject to little dirt or dust.
- To prevent mold, periodically clean the lens as described above. It is recommended that you operate your camcorder about once a month to keep it in optimum state for a long time.

To charge the pre-installed rechargeable battery

Your camcorder has a pre-installed rechargeable battery to retain the date, time, and other settings even when the POWER switch is set to OFF (CHG). The pre-installed rechargeable battery is always charged while you are using your camcorder but it will get discharged gradually if you do not use your camcorder. The rechargeable battery will be fully discharged in **about 3 months** if you do not use your camcorder at all. However, even if the pre-installed rechargeable battery is not charged, the camcorder operation will not be affected as long as you are not recording the date.

■ Procedures

Connect your camcorder to a wall outlet using the AC Adaptor supplied with your camcorder, and leave your camcorder with the POWER switch turned off for more than 24 hours.

Specifications

System

Video compression format

MPEG2/JPEG (Still images)

Hard Disk

DCR-SR40/SR60

30 GB

DCR-SR80

60 GB

When measuring media capacity, 1GB equals 1 billion bytes, a portion of which is used for data management.

Audio compression format

Dolby Digital 2ch

Dolby Digital Stereo Creator

Video signal

NTSC color, EIA standards

Recording format

Movie

MPEG2-PS

Still image

Exif¹ Ver.2.2

Recording/playback time

DCR-SR40/SR60

HQ: Approx. 440 min.

SP: Approx. 650 min.

LP: Approx. 1 250 min.

DCR-SR80

HQ: Approx. 880 min.

SP: Approx. 1 300 min.

LP: Approx. 2 510 min.

Number of recordable movies/still images

Movie: Maximum of 9 999

Still image: Maximum of 9 999

Image device

DCR-SR40

3 mm (1/6 type) CCD (Charge Coupled Device)

Gross:

Approx. 680 000 pixels

Effective (Movie):

Approx. 340 000 pixels

Effective (Still):

Approx. 340 000 pixels

DCR-SR60/SR80

3.27 mm (1/5.5 type) CCD (Charge Coupled Device)

Gross:

Approx. 1 070 000 pixels

Effective (Movie, 4:3)

Approx. 690 000 pixels

Effective (Movie, 16:9)

Approx. 670 000 pixels

Effective (Still, 4:3)

Approx. 1 000 000 pixels

Effective (Still, 16:9)

Approx. 750 000 pixels

Lens

Carl Zeiss Vario Tessar

Filter diameter: 30 mm (1 in.)

DCR-SR40

Optical: 20 × , Digital: 40 × , 800 ×

F=1.8-3.1

DCR-SR60/SR80

Optical: 12 × , Digital: 24 × , 800 ×

F=1.8-2.5

Focal length

DCR-SR40

f=2.3 - 46 mm (3/32 - 1 13/16 in.)

When converted to a 35 mm still camera

For movies:

44 - 880 mm (1 3/4 - 34 1/32 in.)

For still images:

44 - 880 mm (1 3/4 - 34 1/32 in.)

DCR-SR60/SR80

f=3.0 - 36 mm (1/8 - 1 7/16 in.)

When converted to a 35 mm still camera

For movies:

46 - 628.5 mm (1 13/16 - 24 3/4 in.) (16:9)*2

48 - 576 mm (1 15/16 - 22 3/4 in.) (4:3)

For still images:

40 - 480 mm (1 5/8 - 19 in.) (4:3)

43.6 - 523.2 mm (1 3/4 - 20 5/8 in.) (16:9)

Color temperature

[AUTO], [ONE PUSH], [INDOOR] (3 200 K),

[OUTDOOR] (5 800 K)

Minimum illumination

DCR-SR40

5 lx (lux) (F1.8)

0 lx (lux) (in the NightShot plus function)

DCR-SR60/SR80

7 lx (lux) (F1.8)

0 lx (lux) (in the NightShot plus function)

¹ "Exif" is a file format for still images, established by the JEITA (Japan Electronics and Information Technology Industries Association). Files in this format can have additional information such as your camcorder's setting information at the time of recording.

² In 16:9 mode, the focal length figures are actual figures resulting from wide angle pixel readout.

- Manufactured under license from Dolby Laboratories.

Input/Output connectors

DCR-SR40

Audio/Video output

10 pin connector

Video signal: 1 Vp-p, 75 Ω (ohms), unbalanced

Luminance signal: 1 Vp-p, 75 Ω (ohms), unbalanced

Chrominance signal: 0.286 Vp-p, 75 Ω (ohms), unbalanced

Audio signal: 327 mV (at load impedance 47 kΩ (kilohms)), Output impedance less than 2.2 kΩ (kilohms)

DCR-SR60/SR80

Audio/Video input/output

10 pin connector

Input/Output auto switch

Video signal: 1 Vp-p, 75 Ω (ohms), unbalanced

Luminance signal: 1 Vp-p, 75 Ω (ohms), unbalanced

Chrominance signal: 0.286 Vp-p, 75 Ω (ohms), unbalanced

Audio signal: 327 mV (at load impedance 47 kΩ (kilohms)), Input impedance more than 47 kΩ (kilohms), Output impedance less than 2.2 kΩ (kilohms)

REMOTE jack

Stereo mini-minijack (Ø 2.5 mm)

LCD screen

Picture

DCR-SR40

6.2 cm (2.5 type)

DCR-SR60/SR80

6.9 cm (2.7 type, aspect ratio 16:9)

Total number of pixels

123 200 (560 × 220)

General

Power requirements

7.2 V (battery pack)

8.4 V (AC Adaptor)

Average power consumption

DCR-SR40

2.2 W

DCR-SR60/SR80

2.8 W

Operating temperature

0°C to + 40°C (32°F to 104°F)

Storage temperature

-20°C to + 60°C (-4°F to + 140°F)

Dimensions (Approx.)

69 × 71 × 117 mm (2 3/4 × 2 7/8 × 4 5/8 in.) (w×h×d) including protrusions

69 × 71 × 117 mm (2 3/4 × 2 7/8 × 4 5/8 in.) (w×h×d) including protrusions with supplied battery attached

Mass (Approx.)

DCR-SR40

340g (12 oz) main unit only

390g (13 oz) including the NP-FP50 rechargeable battery pack and the lens cap

DCR-SR60

350g (12 oz) main unit only

390g (13 oz) including the NP-FP50 rechargeable battery pack

DCR-SR80

360g (12 oz) main unit only

400g (14 oz) including the NP-FP50 rechargeable battery pack

Supplied accessories

See page 8.

Handycam Station

Input/Output connectors

DCRA-C162 (DCR-SR40)

Audio/Video output

10 pin connector

Video signal: 1 Vp-p, 75 Ω (ohms), unbalanced

Luminance signal: 1 Vp-p, 75 Ω (ohms), unbalanced

Chrominance signal: 0.286 Vp-p, 75 Ω (ohms), unbalanced

Audio signal: 327 mV (at load impedance 47 kΩ (kilohms)), Output impedance less than 2.2 kΩ (kilohms)

USB jack

mini-B

DCRA-C162 (DCR-SR60/SR80)

Audio/Video input/output

10 pin connector

Input/Output auto switch

Video signal: 1 Vp-p, 75 Ω (ohms), unbalanced

Luminance signal: 1 Vp-p, 75 Ω (ohms), unbalanced

Chrominance signal: 0.286 Vp-p, 75 Ω (ohms), unbalanced

Audio signal: 327 mV (at load impedance 47 kΩ (kilohms)), Input impedance more than 47 kΩ (kilohms), Output impedance less than 2.2 kΩ (kilohms)

USB jack

mini-B

AC Adaptor AC-L25A/L25B

Power requirements

AC 100 - 240 V, 50/60 Hz

Current consumption

0.35 - 0.18 A

Power consumption

18 W

Output voltage

DC 8.4 V*

Operating temperature

0°C to +40°C (32°F to 104°F)

Storage temperature

-20°C to +60°C (-4°F to +140°F)

Dimensions (Approx.)

56 × 31 × 100 mm (2 1/4 × 1 1/4 × 4 in.) (w×h×d)
excluding the projecting parts

Mass (Approx.)

190 g (6.7 oz) excluding the power cord

* See at the label of AC Adaptor for other specifications.

Rechargeable battery pack

NP-FP50

Maximum output voltage

DC 8.4 V

Output voltage

DC 7.2 V

Capacity

4.9 wh (680 mAh)

Dimensions (Approx.)

31.8 × 18.5 × 45.0 mm
(1 5/16 × 3/4 × 1 13/16 in.) (w×h×d)

Mass (Approx.)

40 g (1.5 oz)

Operating temperature

0°C to +40°C (32°F to 104°F)

Type

Li-ion

Design and specifications are subject to change without notice.

On trademarks

- “Handycam” and **HANDYCAM** are registered trademarks of Sony Corporation.
- “InfoLITHIUM” is a trademark of Sony Corporation.
- “Memory Stick Duo” is a trademark of Sony Corporation.
- “ImageMixer for HDD Camcorder” is a trademark of Pixela Corporation.
- Dolby and the double-D symbol are trademarks of Dolby Laboratories.
- Dolby Digital Stereo Creator is a trademark of Dolby Laboratories.
- DVD-R, DVD-RW, and DVD+RW logo are trademarks.
- Microsoft, Windows, and Windows Media are either registered trademarks or trademarks of Microsoft Corporation in the United States and/or other countries.
- Macintosh is a trademark of Apple Computer, Inc. in the U.S. and other countries.
- Pentium is a trademark or registered trademark of Intel Corporation.

All other product names mentioned herein may be the trademarks or registered trademarks of their respective companies. Furthermore, ™ and “®” are not mentioned in each case in this manual.

Notes on the License

ANY USE OF THIS PRODUCT OTHER THAN CONSUMER PERSONAL USE IN ANY MANNER THAT COMPLIES WITH THE MPEG-2 STANDARD FOR ENCODING VIDEO INFORMATION FOR PACKAGED MEDIA IS EXPRESSLY PROHIBITED WITHOUT A LICENSE UNDER APPLICABLE PATENTS IN THE MPEG-2 PATENT PORTFOLIO, WHICH LICENSE IS AVAILABLE FROM MPEG LA, L.L.C., 250 STEELE STREET, SUITE 300, DENVER, COLORADO 80206.