

# ***Video Cassette Recorder***

---

Operating Instructions



***SLV-ED939SG***

**Hi-Fi**

***SLV-ED333SG***

# Index to parts and controls

Refer to the pages indicated in parentheses ( ) for details.

## Front panel

For SLV-ED939SG

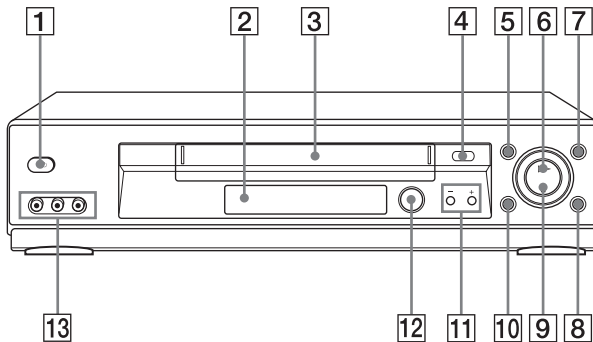

**1** I/⏻ ON/STANDBY switch

**2** Remote sensor

**3** Tape compartment

**4** ⏏ EJECT button (28)

**5** ◀◀ REW (rewind) button (28)

**6** ▷ PLAY button\* (28)

**7** ▶▶ FF (fast-forward) button (28)

**8** ● REC (record) button (17) (29)  
(Back cover)

**9** ■ STOP button\* (9) (28) (Back cover)

**10** || PAUSE button (24) (28) (Back cover)

**11** PROGRAM/TRACKING +/- buttons\* (20)

**12** EASY TIMER (19)

**13** ● LINE-2 IN VIDEO/AUDIO L/R  
(left/right) jacks (30)

\* The ▷ PLAY, ■ STOP and PROGRAM/TRACKING + buttons have a tactile dot.

# For SLV-ED333SG

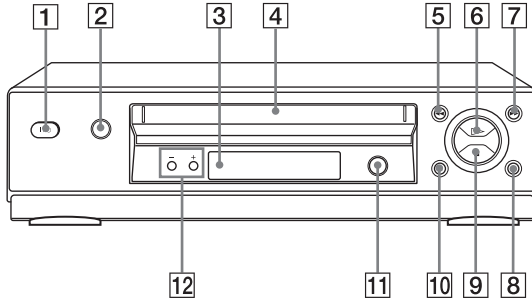

- 1** I/⏻ ON/STANDBY switch
- 2** ≡ EJECT button (28)
- 3** Remote sensor
- 4** Tape compartment
- 5** ◀◀ REW (rewind) button (28)
- 6** ▷ PLAY button (28)
- 7** ▶▶ FF (fast-forward) button (28)

- 8** ● REC (record) button (17) (29) (Back cover)
- 9** ■ STOP button (9) (28) (Back cover)
- 10** || PAUSE button (24) (28) (Back cover)
- 11** EASY TIMER (19)
- 12** PROGRAM/TRACKING +/- buttons\* (20)

\* The PROGRAM/TRACKING + button has a tactile dot.

**Index to parts and controls (continued)**

**Remote commander**

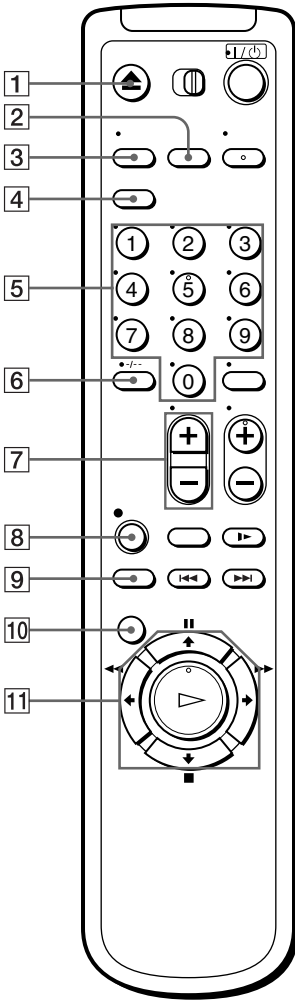

- 1** ▲ EJECT button (28)
- 2** INPUT SELECT button (17) (25)  
(Back cover)
- 3** TV/VIDEO button (*for TV*)
- 4** CLEAR button (14)
- 5** Programme number buttons\*
- 6** -/-- (ten's digit) button
- 7** VOL (volume) +/- buttons
- 8** ● REC (record) button (17) (29)
- 9** REC SPEED (recording speed) button
- 10** MENU button (12)
- 11** ■ PAUSE/▲ button (12) (28)  
■ STOP/▼ button (12) (28)  
◀◀ REW (rewind)/← button (12) (28)  
▶▶ FF (fast-forward)/→ button (12) (28)  
▷ PLAY/OK button\* (12) (28)

\* The ▷ PLAY, AUDIO MONITOR, number 5 and PROG + buttons have a tactile dot.

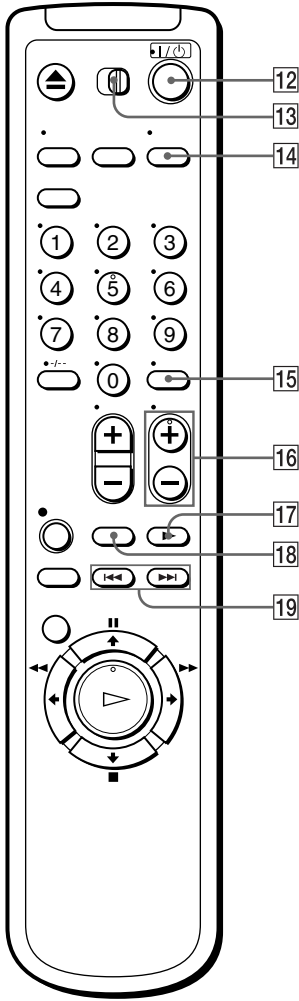

- 12** I/⏻ (on/standby) switch (26)
- 13** •TV/VIDEO remote control switch
- 14** AUDIO MONITOR button\*<sup>1</sup>\*<sup>2</sup>
- 15** DISPLAY button (18)
- 16** PROG (programme) +/- buttons\*<sup>1</sup>
- 17** ► SLOW button (28)
- 18** ×2 button (28)
- 19** ◀◀/▶▶ INDEX SEARCH buttons

\*<sup>1</sup> The ▷ PLAY, AUDIO MONITOR, number 5 and PROG + buttons have a tactile dot.

\*<sup>2</sup> SLV-ED939SG only

# Connecting the VCR

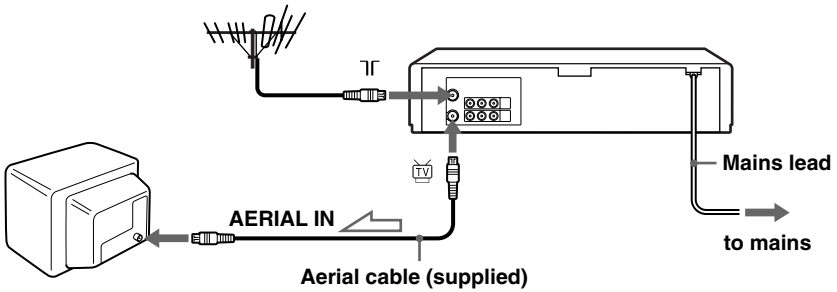

 : Signal flow

**1**

Disconnect the aerial cable from your TV and connect it to  on the rear panel of the VCR.

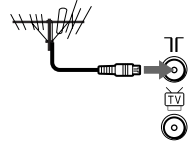

**2**

Connect  of the VCR and the aerial input of your TV using the supplied aerial cable.

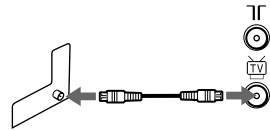

**3**

Connect the mains lead to the mains.

## Note

- When you connect the VCR and your TV only with an aerial cable, you have to tune your TV to the VCR (see page 8).

## Additional connections

### To a TV that has audio/ video input jacks

This additional connection improves picture and sound quality. Connect the TV as shown on the left.

For SLV-ED939SG

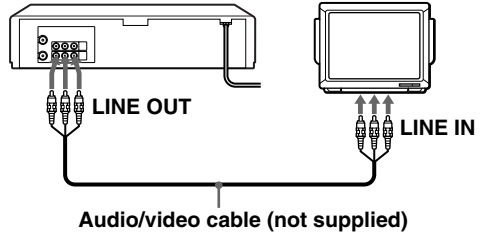

For SLV-ED333SG

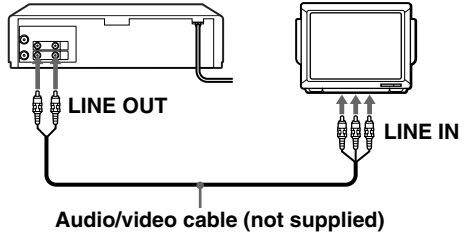

# Setting up the VCR with the Auto Set Up function

Before using the VCR for the first time, set up the VCR using the Auto Set Up function. With this function, you can set the language for the on-screen display and TV channels automatically.

1

Turn on your TV and set it to the video channel.

Tune the TV to channel 32 (the initial RF channel for this VCR). Refer to your TV manual for TV tuning instructions.

2



Connect the mains lead to the mains.

The VCR automatically turns on.

The LANGUAGE SET menu appears on the TV screen.

Press  $\leftarrow/\rightarrow$  to select the desired language, ENGLISH or ARABIC, then press OK.

The message for the Auto Set Up function appears.



3



Press OK.

The SYSTEM SELECT menu appears.

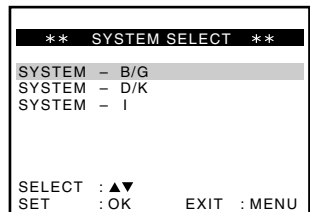



# 4



Press **↑/↓/←/→** to select the appropriate TV system, then press OK.

The VCR starts searching for all of the receivable channels and presets them (in the appropriate order for your local area).

If you want to disable unwanted programme positions, see “Disabling unwanted programme positions” on page 14.

After the search is complete, the clock setting menu appears. See “Setting the clock” on page 10.

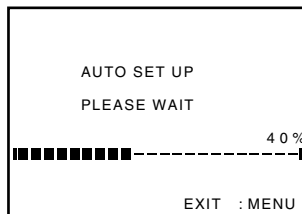

## To cancel the Auto Set Up function

Press MENU.

### Notes

- Whenever you operate the Auto Set Up function, some of the settings (timer, etc.) will be reset. If this happens, you have to set them again.
- Auto preset starts automatically only when you plug in the mains lead for the first time after you purchase the VCR.
- After using the Auto Set Up function, the LANGUAGE SET menu does not appear automatically when you connect the mains lead again. If you want to use the Auto Set Up function again, press MENU, then press **↑/↓/←/→** to highlight INSTALLATION and press OK. Press **↑/↓** to highlight AUTO SET UP, then repeat all procedures from step 3.
- Auto preset can be performed by pressing **■ STOP on the VCR** continuously for 5 seconds or more with no tape inserted.

# Setting the clock

You must set the time and date on the VCR to use the timer features properly.

## Before you start...

- Turn on the VCR and the TV.
- Set the TV to the video channel.
- Refer to "Index to parts and controls" for button locations.

1

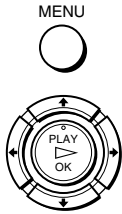

Press MENU, then press **↑/↓/←/→** to highlight CLOCK SET and press OK.

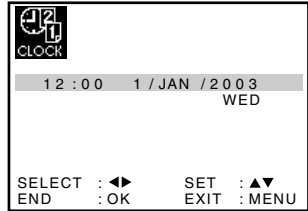

2



Press **↑/↓** to set the hour.

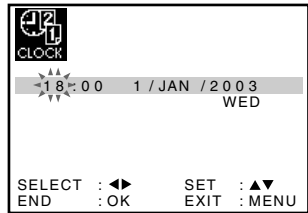

3



Press **→** to select the minutes and set the minutes by pressing **↑/↓**.

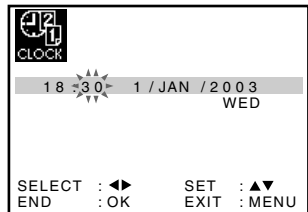

---

4



Set the day, month, and year in sequence by pressing → to select the item to be set, and press ↑/↓ to select the digits, then press →.

The day of the week is set automatically.

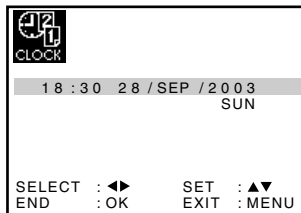

---

5



Press MENU to exit the menu.

---

# Presetting channels

If some channels could not be preset using the Auto Set Up function, you can preset them manually.

## Before you start...

- Turn on the VCR and the TV.
- Set the TV to the video channel.
- Refer to "Index to parts and controls" for button locations.

1

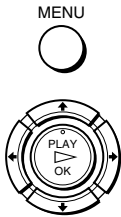

Press MENU, then press **↑/↓/←/→** to highlight INSTALLATION and press OK.

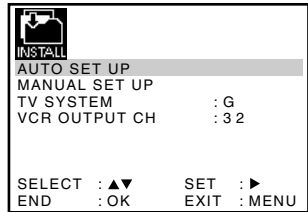

2



Press **↑/↓** to highlight MANUAL SET UP, then press **→**.

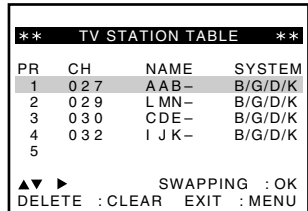

3



Press **↑/↓** to highlight the row which you want to preset, then press **→**.

To display other pages for programme positions 6 to 80, press **↑/↓** repeatedly.

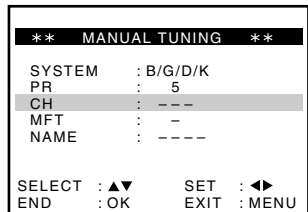

4



Press **←/→** repeatedly until the channel you want is displayed. Select the appropriate TV system, if necessary.

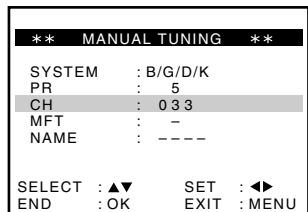

5



Press **↑/↓** to highlight NAME, then press **→**.

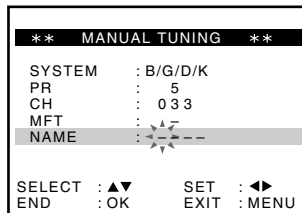

6



Enter the station name.

1 Press **↑/↓** to select a character.

Each time you press **↑**, the character changes as shown below.

**A → B → ... → Z → 0 → 1 → ... → 9 → A**

2 Press **→** to set the next character.

The next space flashes.

To correct a character, press **←/→** until the character you want to correct flashes, then reset it.

You can set up to 4 characters for the station name.

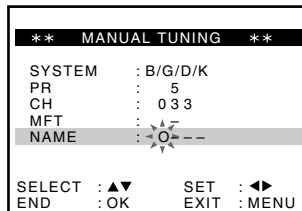

7



Press OK to confirm the station name.

8



Press MENU to exit the menu.

**Note**

- If the TV sound is distorted or noisy, select the appropriate TV system (“G”, “K” or “I”) for your area.

*continued*

## Presetting channels (continued)

### Disabling unwanted programme positions

After presetting channels, you can disable unused programme positions. The disabled positions will be skipped later when you press the PROG +/- buttons.

1

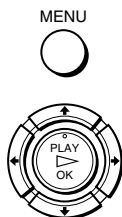

Press MENU, then press **↑/↓/←/→** to highlight INSTALLATION, and press OK.

<b>INSTALL</b>	
AUTO SET UP	
MANUAL SET UP	
TV SYSTEM	: G
VCR OUTPUT CH	: 3 2
SELECT : ▲▼	SET : ►
END : OK	EXIT : MENU

2



Press **↑/↓** to highlight MANUAL SET UP, then press **→**.

** TV STATION TABLE **			
PR	CH	NAME	SYSTEM
1	0 2 7	A A B -	B/G/D/K
2	0 2 9	L M N -	B/G/D/K
3	0 3 0	C D E -	B/G/D/K
4	0 3 2	I J K -	B/G/D/K
5			
▲▼ ►		SWAPPING	: OK
DELETE		: CLEAR	EXIT : MENU

3



Press **↑/↓** to highlight the row which you want to disable.  
To display other pages for programme positions 6 to 80, press **↑/↓** repeatedly.

** TV STATION TABLE **			
PR	CH	NAME	SYSTEM
1	0 2 7	A A B -	B/G/D/K
2	0 2 9	L M N -	B/G/D/K
3	0 3 0	C D E -	B/G/D/K
4	0 3 2	I J K -	B/G/D/K
5			
▲▼ ►		SWAPPING	: OK
DELETE		: CLEAR	EXIT : MENU

4



Press CLEAR.  
The selected row will be cleared as shown on the left.

** TV STATION TABLE **			
PR	CH	NAME	SYSTEM
1	0 2 7	A A B -	B/G/D/K
2			
3	0 3 0	C D E -	B/G/D/K
4	0 3 2	I J K -	B/G/D/K
5			
▲▼ ►		SWAPPING	: OK
DELETE		: CLEAR	EXIT : MENU

5

Repeat steps 3 and 4 for any other programme positions you want to disable.

6

MENU



Press MENU to exit the menu.

## Changing the station names

You can change or enter the station names (up to 4 characters).

### Before you start...

- Turn on the VCR and the TV.
- Set the TV to the video channel.
- Refer to “Index to parts and controls” for button locations.

1

MENU



Press MENU, then press **↑/↓/←/→** to highlight INSTALLATION and press OK.

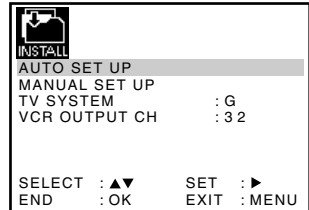

2



Press **↑/↓** to highlight MANUAL SET UP, then press **→**.

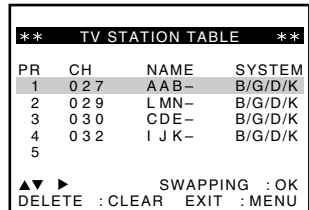

3



Press **↑/↓** to highlight the row which you want to change or enter the station name, then press **→**.

To display other pages for programme positions 6 to 80, press **↑/↓** repeatedly.

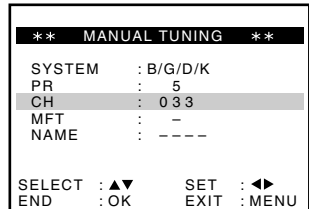

*continued*

## Presetting channels (continued)

4



Press  $\uparrow/\downarrow$  to highlight NAME, then press  $\rightarrow$ .

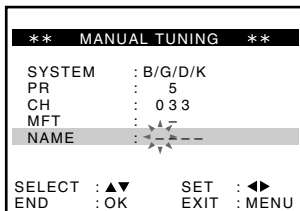

5



Enter the station name.

1 Press  $\uparrow/\downarrow$  to select a character.

Each time you press  $\uparrow$ , the character changes as shown below.

A  $\rightarrow$  B  $\rightarrow$  ...  $\rightarrow$  Z  $\rightarrow$  0  $\rightarrow$  1  
 $\rightarrow$  ...  $\rightarrow$  9  $\rightarrow$  A

2 Press  $\rightarrow$  to set the next character.

The next space flashes.

To correct a character, press  $\leftarrow/\rightarrow$  until the character you want to correct flashes, then reset it.

You can set up to 4 characters for the station name.

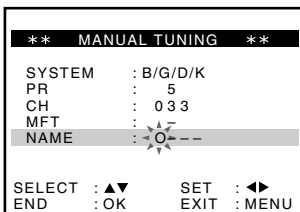

6



Press OK to confirm the new name.

7



Press MENU to exit the menu.



# Recording TV programmes

## Before you start...

- Refer to “Index to parts and controls” for button locations.

**1** Turn on your TV and set it to the video channel.

**2** Insert a tape with its safety tab in place.

**3** • To record a normal channel, press PROG +/- until the programme position number you want appears in the display window.

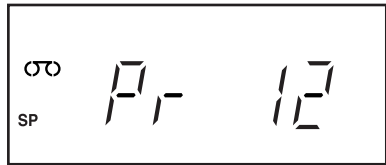
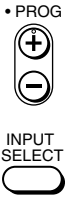

- To record from other equipment connected to one or more of the LINE inputs, press INPUT SELECT to display the connected line in the display window.



**4** Press **REC** to start recording.  
The recording indicator lights up red in the display window.



Recording indicator

*continued*

## **Recording TV programmes (continued)**

### **To stop recording**

Press ■STOP.

### **To check the remaining time**

Press DISPLAY. Each time you press DISPLAY, the display changes as shown below.

Sound system, TV system, colour system, programme position, tape speed and time counter → Remaining time → Current date and time, and time counter

In order to get an accurate remaining time indication, be sure TAPE SELECT in the USER SET menu is set according to the tape type you use.

### **To watch another TV programme while recording**

- 1** If the TV is connected to the VCR using an audio/video cable, set the TV to TV input. If the TV is connected to the VCR using only the aerial cable, skip this step.
- 2** Select another programme position on the TV.

### **To save a recording**

To prevent accidental erasure, break off the safety tab as illustrated. To record on the same tape again, cover the tab hole with adhesive tape.

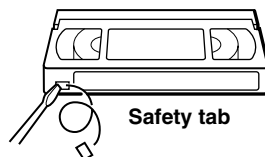

# Recording TV programmes using the Easy Timer

The Easy Timer function allows you to make timer recordings of programmes without turning on your TV. Set the recording timer to record up to eight programmes, including settings made with other timer methods, that will be broadcast within the next month. The recording start time and recording stop time can be set at one minute intervals.

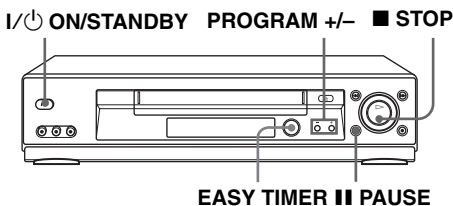

## Before you start...

- Insert a tape with its safety tab in place. Make sure the tape is longer than the total recording time.
- Refer to “Index to parts and controls” for button locations.

1

EASY TIMER



Press EASY TIMER.

“DATE” and “TODAY” appear alternately in the display window.

If the date and time are not set, “DAY” will appear. See step 2 in the following section, “To set the clock” to set the date and time.

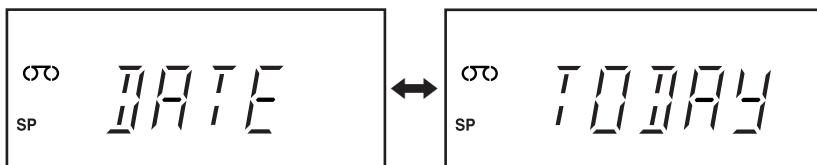

2

EASY TIMER

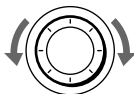

Turn EASY TIMER to set the recording date.

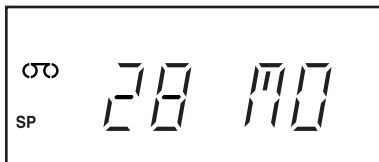

*continued*

## Recording TV programmes using the Easy Timer (continued)

**3**

EASY TIMER

Press EASY TIMER.



START indicator and the current time appear in the display window.



**4**

EASY TIMER

Turn EASY TIMER to set the recording start time.



You can set the recording start time in 15 minute intervals or adjust the time in one minute intervals by pressing the PROGRAM +/- buttons.

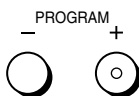

**5**

EASY TIMER

Press EASY TIMER.



STOP indicator and the recording stop time appear in the display window.



**6**

EASY TIMER

Turn EASY TIMER to set the recording stop time.

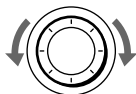

You can set the recording stop time in 15 minute intervals or adjust the time in one minute intervals by pressing the PROGRAM +/- buttons.



**7**

EASY TIMER

Press EASY TIMER.



The programme position or LINE input appears in the display window.

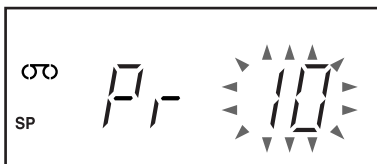

**8**

EASY TIMER

Turn EASY TIMER to set the programme position.

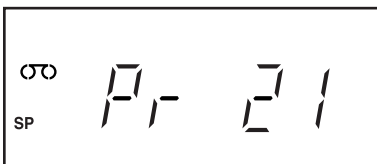
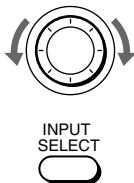

To record from other equipment connected to one or more of the LINE inputs, turn EASY TIMER or press INPUT SELECT to display the connected line in the display window.

**9**

EASY TIMER

Press EASY TIMER.



The current tape speed mode appears in the display window.



**10**

EASY TIMER

Turn EASY TIMER to set the tape speed, SP, LP or AUTO.

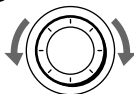

*continued*

# 11

EASY TIMER



Press EASY TIMER to complete the setting.

“OK” appears in the display window for about five seconds.

The ⊖ indicator appears in the display window and the VCR stands by for recording.

To record from other equipment, leave the connected equipment switched on.

### To return to the previous step

To return to the previous step, press the PROGRAM + and – buttons on the VCR at the same time during any of the Easy Timer settings.

### To stop recording

To stop the VCR while recording, press ■STOP.

### To use the VCR after setting the timer

To use the VCR before a recording begins, just press I/⏻. The ⊖ indicator turns off and the VCR switches on. Remember to press I/⏻ to reset the VCR to recording standby after using the VCR.

You can also do the following tasks while the VCR is recording:

- Reset the counter.
- Display tape information on the TV screen (page 18).
- Check the timer settings.
- Watch another TV programme (page 18).

### To use the Auto Tape Speed function

In step 10 above, turn EASY TIMER to select AUTO. When you are recording a programme in the SP mode and the remaining tape length becomes shorter than the recording time, the recording tape speed is automatically changed to the LP mode (or EP mode when you are recording NTSC signals). Note that some noise will appear on the picture when the tape speed is changed. To operate this function correctly, the “TAPE SELECT” setting in the USER SET menu must be accurate.

## To set the clock

- 1** Hold down EASY TIMER so that “DAY” appears in the display window. However, if the clock has already been set, the current setting appears.
- 2** Turn EASY TIMER to set the day.
- 3** Press EASY TIMER.  
MONTH indicator and “1” appear in the display window.
- 4** Turn and press EASY TIMER to set the month, and then the year.  
After you set the year, “CLOCK” appears in the display window.
- 5** Turn and press EASY TIMER to set the hour and minute.
- 6** When you have finished setting the time, press EASY TIMER to start the clock.

## Tips

- To cancel a Easy Timer setting, press ■ **STOP on the VCR** while you are making the setting.
- To record NTSC signals in EP mode, set the tape speed to LP. Even when timer recording is set to LP mode, NTSC signals are automatically recorded in EP mode.

## Notes

- If eight programmes have already been set using the TIMER PROGRAMMING menu, “FULL” appears in the display window for about five seconds.
- The ☉ indicator flashes in the display window when you complete the setting in step 11 with no tape inserted.
- When the time is set incorrectly, “ERROR” appears in the display window in step 11. Set the timer again from step 1.

## ***Recording TV programmes using the Easy Timer (continued)***

### **About the Demonstration Mode**

The Easy Timer function has a Demonstration Mode that allows the user, such as a salesperson, to enter more than eight examples of timer settings when demonstrating the use of the Easy Timer. It cancels the “FULL” notice which appears if eight programmes have already been set. Do not use the Demonstration Mode for making timer recordings. Doing so may cause the settings to be inaccurate.

#### **To activate the Demonstration Mode**

Press **■** PAUSE on the VCR while turning the EASY TIMER. “DEMO” appears in the display window for a few seconds.

#### **To cancel the Demonstration Mode**

Turn the power off and unplug the mains lead. Although the Demonstration Mode is cancelled, the timer settings entered while using the Demonstration Mode will remain. Be sure to manually cancel the timer settings before you use the Easy Timer or any other timer method after reconnecting the mains lead.



# Recording TV programmes using the timer

You can preset a total of eight programmes, including settings made with other timer methods.

## Before you start...

- Check that the VCR clock is set to the correct time and date.
- Insert a tape with its safety tab in place. Make sure the tape is longer than the total recording time.
- Turn on your TV and set it to the video channel.
- Refer to “Index to parts and controls” for button locations.

**1**

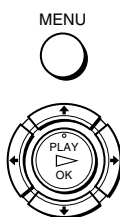

Press **MENU**, then press **↑** / **↓** / **←** / **→** to highlight **TIMER PROGRAMMING** and press **OK**.

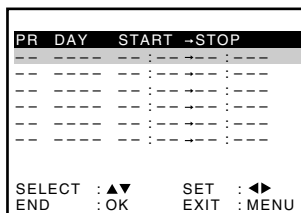

**2**

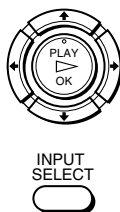

Set the date, start and stop times and tape speed:

**1** Press **→** to select each item in turn.

**2** Press **↑** / **↓** to set each item.

To correct a setting, press **←** to return to that setting and reset.

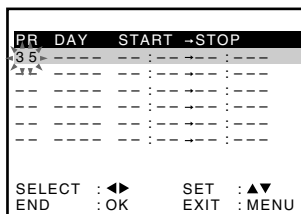

- To record the same programme every day or the same day every week, see “Daily/weekly recording” on page 26.
- To record from other equipment connected to one or more of the **LINE** inputs, press **INPUT SELECT** to display the connected line in the “PR” position.

**3**



Press **MENU** to exit the menu.

*continued*

4



Press I/⏻ to turn off the VCR.

The ⏻ indicator appears in the display window and the VCR stands by for recording.

To record from other equipment, leave the connected equipment switched on.

### To stop recording

To stop the VCR while recording, press ■STOP.

### Daily/weekly recording

In step 2 above, press ↓ to select the recording pattern. Each time you press ↓, the indication changes as shown below. Press ↑ to change the indication in reverse order.

**today** → **DLY (Monday to Sunday)** → **W-SA (every Saturday) .....**  
→ **W-SU (every Sunday)** → **1 month later** → **(dates count down)**  
→ **today**

### To use the VCR after setting the timer

To use the VCR before a recording begins, just press I/⏻. The ⏻ indicator turns off and the VCR switches on. Remember to press I/⏻ to reset the VCR to recording standby after using the VCR.

You can also do the following tasks while the VCR is recording:

- Reset the counter.
- Display tape information on the TV screen (page 18).
- Check the timer settings.
- Watch another TV programme (page 18).

### To use the Auto Tape Speed function

In step 2 above, press ↓ to select AUTO. When you are recording a programme in the SP mode and the remaining tape length becomes shorter than the recording time, the recording tape speed is automatically changed to the LP mode (or EP mode when you are recording NTSC signals). Note that some noise will appear on the picture when the tape speed is changed. To operate this function correctly, the “TAPE SELECT” setting in the USER SET menu must be accurate.

**Tips**

- To set the line input video source, you can also use the INPUT SELECT button.
- To record NTSC signals in EP mode, set the tape speed to LP. Even when timer recording is set to LP mode, NTSC signals are automatically recorded in EP mode.

**Note**

- The ⊕ and ⊖ indicators flash in the display window when you press I/⏻ with no tape inserted.

# Playing/searching at various speeds

## Before you start...

- Refer to “Index to parts and controls” for button locations.

Playback options	Operation
Play a tape	Press ▷ PLAY.
Stop play	Press ■ STOP.
Pause play	Press    PAUSE.
Resume play after pause	Press    PAUSE or ▷ PLAY.
Fast-forward the tape	Press ►► FF during stop.
Rewind the tape	Press ◄◄ REW during stop.
View the picture during fast-forward or rewind	During fast-forward, hold down ►► FF. During rewind, hold down ◄◄ REW.
Play at high speed	<ul style="list-style-type: none"><li>• During playback, press ►► FF or ◄◄ REW <u>on the remote commander</u>.</li><li>• During playback, hold down ►► FF or ◄◄ REW. When you release the button, normal playback resumes.</li></ul>
Play at twice the normal speed	During playback, press ×2.
Play in slow motion	During playback, press ► SLOW.
Play frame by frame	During pause, press ►► FF <u>on the remote commander</u> .
Eject the tape	Press ▲ EJECT.

## To resume normal playback

Press ▷ PLAY.

# Setting the recording duration time

After you have started recording in the normal way, you can have the VCR stop recording automatically after a specified duration.

## Before you start...

- Refer to “Index to parts and controls” for button locations.

**1** While recording, press ●REC.

The ⊖ indicator appears in the display window.

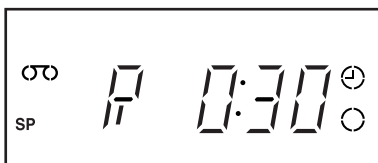

**2** Press ●REC repeatedly to set the duration time.

In SP mode

Each press advances the time in increments of 30 minutes.

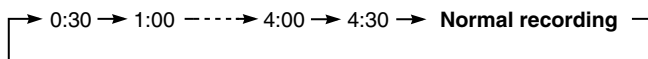

In LP (EP) mode

Each press advances the time as shown below.

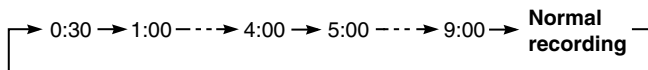

The tape counter decreases minute by minute to 0:00, then the VCR stops recording and turns off automatically.

## To extend the duration

Press ●REC repeatedly to set a new duration time.

## To cancel the duration

Press ●REC repeatedly until the ⊖ indicator disappears and the VCR returns to the normal recording mode.

## To stop recording

To stop the VCR while recording, press ■STOP.

## Note

- You cannot display the current tape time in the display window when setting the recording duration time.

# Editing with another VCR

## How to connect to record on this VCR

Connect the line outputs of the other VCR to the input connector of this VCR. Refer to the examples A and B and choose the connection that best suits your VCR.

### Example A (SLV-ED333SG only)

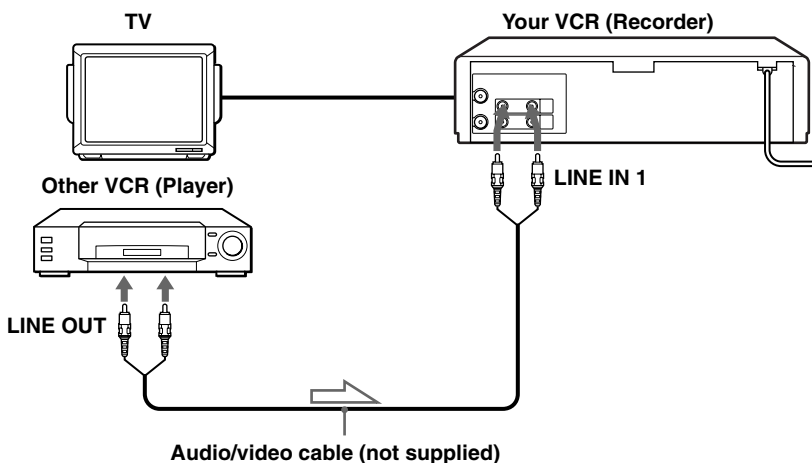

▸ : Signal flow

### Example B (SLV-ED939SG only)

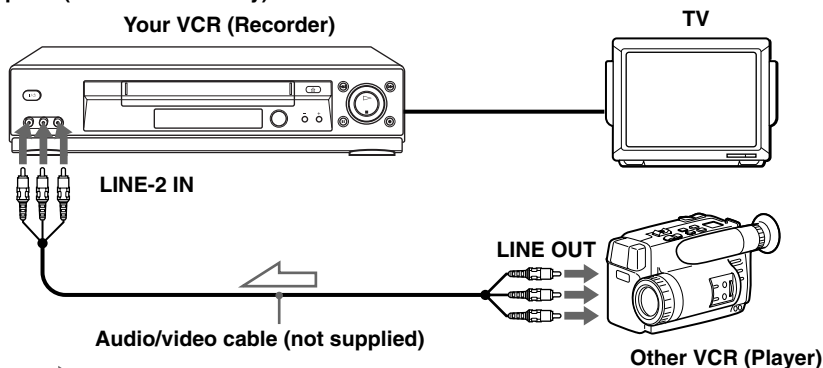

▸ : Signal flow

**Example C (SLV-ED939SG only)**

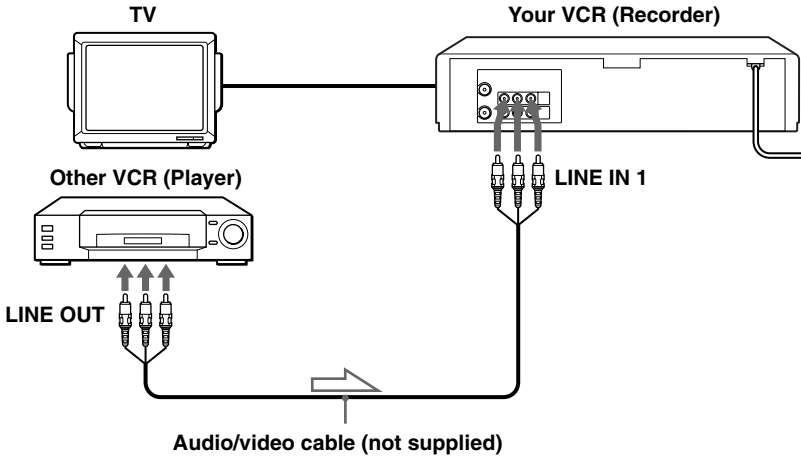

 : Signal flow

**How to connect to a stereo system (SLV-ED939SG only)**

Connect the LINE-2 IN jacks on this VCR to the audio output jacks on the stereo system, using an audio cable (not supplied).

**Notes**

- Make sure you connect the plugs to jacks of the same colour.
- If the other VCR is a monaural type, leave the red plugs unconnected.
- If you connect this VCR to both the LINE IN and LINE OUT jacks of the other VCR, select the input correctly to prevent a humming noise.
- When you connect another VCR to the LINE-2 IN\* connector, press INPUT SELECT to display “L2” in the display window.

\* SLV-ED939SG only

*continued*

## Editing with another VCR (continued)

### Operation (When recording on this VCR)

#### Before you start editing

- Turn on your TV and set it to the video channel.
- Press INPUT SELECT to display the connected line in the display window.
- Press REC SPEED to select the tape speed.

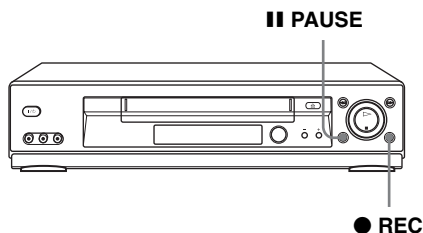

- 1** Insert a source tape with its safety tab removed into the other (playback) VCR. Search for the point to start playback and set it to playback pause.
- 2** Insert a tape with its safety tab in place into this (recording) VCR. Search for the point to start recording and press **II PAUSE** to set it to playback pause.
- 3** Press **● REC** on this VCR to set it to recording pause.
- 4** To start editing, press the **II PAUSE** buttons on both VCRs at the same time.

#### To stop editing

Press the **■ STOP** buttons on both VCRs.

#### Tip

- To cut out unwanted scenes while editing, press **II PAUSE** on this VCR when an unwanted scene begins. When it ends, press **II PAUSE** again to resume recording.