

# Portable CD Player

---

## Operating Instructions

### About the area code

The area code of the location in which you purchased the CD player is shown on upper left of the bar code label on the package.

For accessories supplied with your CD player, check the area code of your model and see "Accessories (supplied/optional)."



"WALKMAN" is a trademark of Sony Corporation.

## *D-EJ1000*

## WARNING

To prevent fire or shock hazard, do not expose the unit to rain or moisture.

Do not install the appliance in a confined space, such as a bookcase or built-in cabinet.

To prevent fire, do not cover the ventilation of the apparatus with newspapers, tablecloths, curtains, etc. And don't place lighted candles on the apparatus.

To prevent fire or shock hazard, do not place objects filled with liquids, such as vases, on the apparatus.

Treat batteries as toxic waste. Do not dispose with regular garbage.

Certain countries may regulate disposal of the battery used to power this product. Please consult with your local authority.

 The CE mark is valid only for products marketed in the European Union.

# Table of Contents

## Getting started

Locating the controls .....	4
-----------------------------	---

## Playing a CD

<b>1.</b> Connect your CD player. ....	7
<b>2.</b> Insert a CD. ....	7
<b>3.</b> Play a CD. ....	8

## Playback options

Playing tracks repeatedly (Repeat play) ...	11
Playing a single track (Single play) .....	11
Playing tracks in random order (Shuffle play) .....	11
Playing tracks in your favorite order (PGM play) .....	12

## Available features

G-PROTECTION function .....	13
Displaying CD text information .....	13
Checking the remaining time on the CD and the number of tracks left .....	14
Emphasizing the bass sound (SOUND) ....	14
Protecting your hearing (AVLS) .....	15
Locking the controls (HOLD) .....	15
Turning off the operation beep sound .....	16
Turning off the LCD's backlight .....	16

## Connecting your CD player

Connecting a stereo system .....	17
----------------------------------	----

## Connecting to a power source

Using the rechargeable batteries .....	19
Using the dry batteries .....	22
Notes on the power source .....	23

## Additional information

Precautions .....	24
Maintenance .....	24
Troubleshooting .....	25
Specifications .....	27
Accessories (supplied/optional) ..	Back cover

# Getting started

## Locating the controls

For details, see pages in parentheses.

### CD player (front)

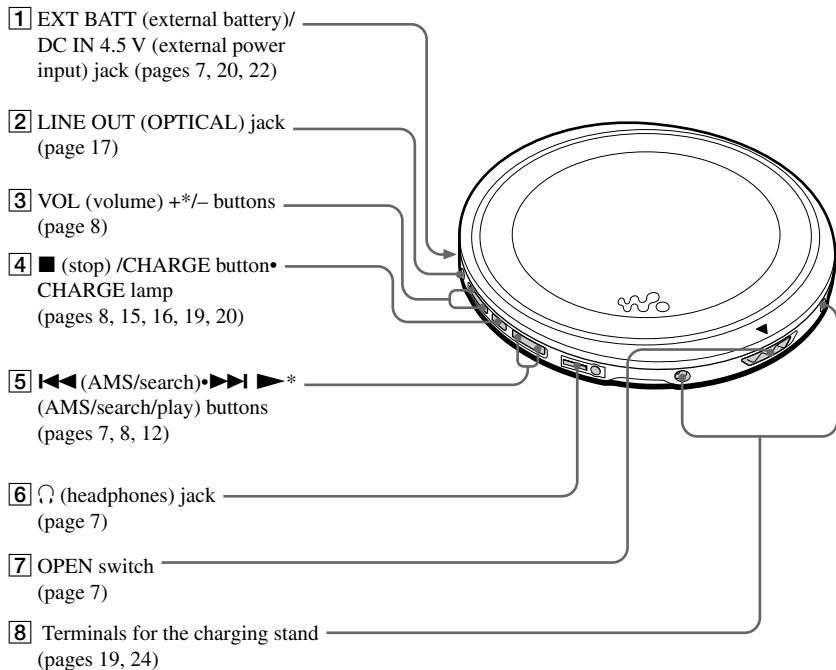

### CD player (inside)

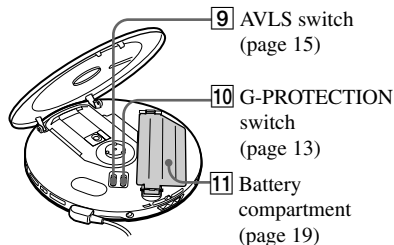

### CD player (rear)

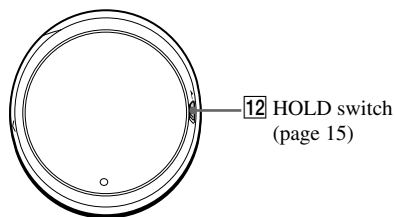

## Remote control

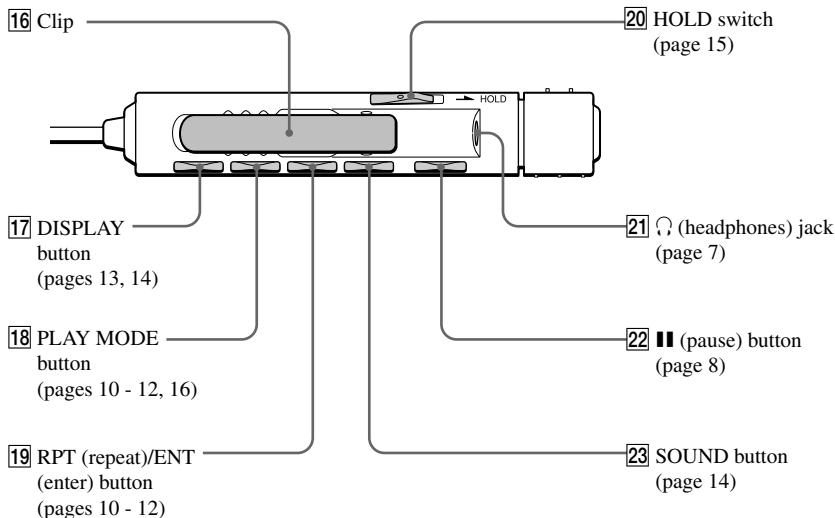
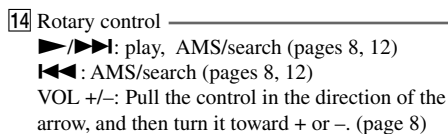
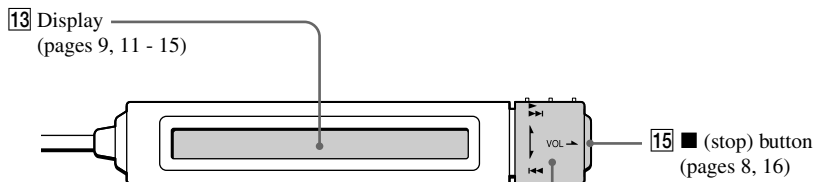

### Note

Use only the supplied remote control. You cannot operate this CD player with the remote control supplied with other CD players.

## Using the carrying pouch

You can carry your player and its battery case together using the supplied carrying pouch. Insert them into the proper places in the pouch as illustrated below.

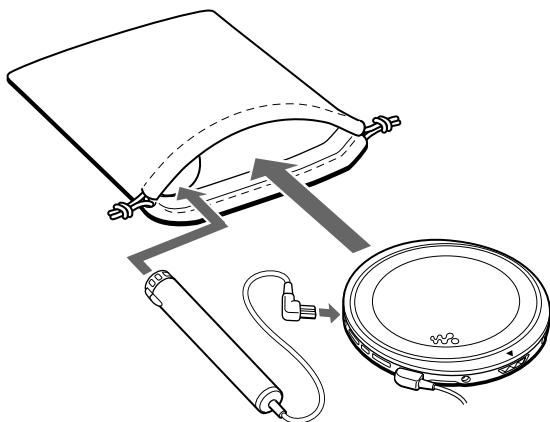

# Playing a CD

You can also use rechargeable batteries and dry batteries as a power source.

## 1. Connect your CD player.

- 1 Connect the AC power adaptor.
- 2 Connect the headphones/earphones with remote control.

### For models supplied with the remote control

- Connect the plug of the headphones/earphones to the remote control.
- Connect the headphones/earphones to the remote control firmly. A loose connection may cause noise during playback.

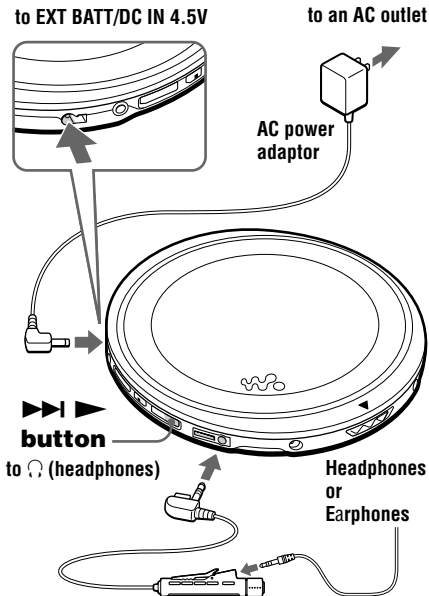

## 2. Insert a CD.

- 1 Slide OPEN to open the CD player lid.
- 2 Place the CD on the tray and close the lid.

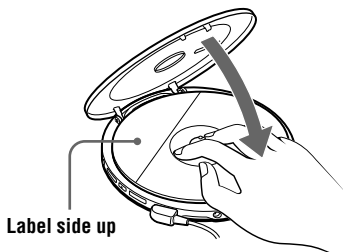
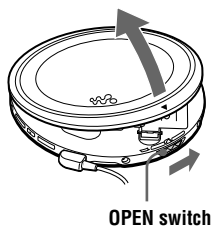

(Continued)

### 3. Play a CD.

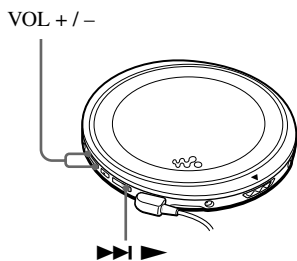

- 1 Press ▶▶▶▶.
- 2 Adjust the volume by pressing VOL + or -.

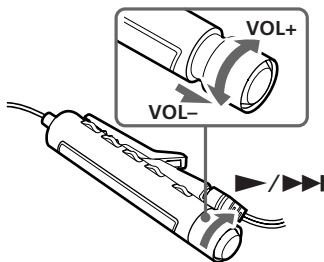

- 1 Turn the rotary control toward ▶▶▶▶.
- 2 Pull the rotary control in the direction of the arrow.
- 3 Adjust the volume by turning the rotary control toward VOL + or -.

To	Do this on the remote control
Play (from the point you stopped)	Turn the rotary control toward ▶▶▶▶ (press ▶▶▶▶ for the CD player). Playback starts from the point you stopped.
Play (from the first track)	Turn the rotary control toward ▶▶▶▶ and hold it until the play of the first track starts (press ▶▶▶▶ for 2 seconds or more for the CD player).
Pause/resume play after pause	Press ■■.
Stop	Press ■ (■/CHARGE for the CD player). <sup>*2</sup>
Find the beginning of the current track (AMS <sup>*1</sup> )	Turn the rotary control toward ◀◀◀ once. <sup>*2</sup>
Find the beginning of the previous tracks (AMS)	Turn the rotary control toward ◀◀◀ repeatedly. <sup>*2, *3</sup>
Find the beginning of the next track (AMS)	Turn the rotary control toward ▶▶▶▶ once. <sup>*2, *3</sup>
Find the beginning of the succeeding tracks (AMS)	Turn the rotary control toward ▶▶▶▶ repeatedly. <sup>*2, *3</sup>
Go backwards quickly	Turn the rotary control toward ◀◀◀ and hold it. <sup>*2</sup>
Go forward quickly	Turn the rotary control toward ▶▶▶▶ and hold it. <sup>*2</sup>

<sup>\*1</sup> Automatic Music Sensor

<sup>\*2</sup> These operations can be done during both play and pause.

<sup>\*3</sup> You can locate the first track after the last track by turning the rotary control toward ▶▶▶▶ repeatedly.

You can also locate the last track after the first track by turning the rotary control toward ◀◀◀ repeatedly.



## About the display

- When you turn the rotary control toward ►/►► (press ►►► ► for the CD player) after changing the CD or turning off and on the player, the total number of tracks in the CD and total playing time appear for about two seconds.
- During play, the track number and the elapsed playing time of the current track appear.
- During pause, the elapsed playing time flashes.

## If the volume level does not increase

- If AVLS is set to “LIMIT”, set it to “NORM.” For details, see “Protecting your hearing (AVLS).”
- If the headphones are connected to the LINE OUT (OPTICAL) jack, connect them to the  (headphones) jack.

## About CD-Rs/CD-RWs

This CD player can play CD-Rs/CD-RWs recorded in the CD-DA format\*, but playback capability may vary depending on the quality of the disc and the condition of the recording device.

\* CD-DA is the abbreviation for Compact Disc Digital Audio. It is a recording standard used for the Audio CDs.

## Removing the CD

Remove the CD while pressing the pivot in the center of the tray.

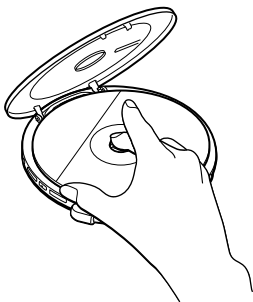

# Playback options

You can enjoy various ways of playback using the PLAY MODE button and the RPT (repeat)/ENT (enter) button.

## PLAY MODE button

Each time you press the button, you can change the playback mode.

No indication  
(Normal play)

↓

"1"  
(Play a single track)

↓

"SHUF"  
(Play tracks in random order)

↓

"PGM"  
(Play tracks in your favorite order)

## RPT/ENT button

### RPT (repeat)

You can repeat play that is selected using PLAY MODE.

### ENT (enter)

You can select tracks for PGM play mode.

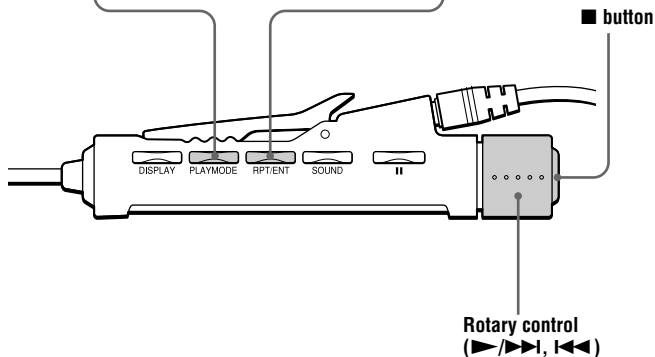

## Playing tracks repeatedly (Repeat play)

You can play tracks repeatedly in normal, single, shuffle and PGM play modes.

During playback, press RPT/ENT.



## Playing a single track (Single play)

During playback, press PLAY MODE repeatedly until "1" appears.



## Playing tracks in random order (Shuffle play)

During playback, press PLAY MODE repeatedly until "SHUF" appears.

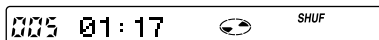

## Playing tracks in your favorite order (PGM play)

You can program the CD player to play up to 64 tracks in your favorite order.

- 1** During playback, press **PLAY MODE** repeatedly until “PGM” appears.

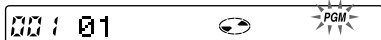

- 2** Turn the rotary control toward **▶/▶▶** or **◀◀◀** to select a track.

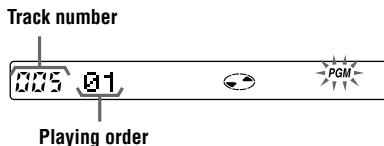

- 3** Press **RPT/ENT** to enter the selected track.  
“000” appears and the playing order increases by one.



- 4** Repeat steps 2 and 3 to select the tracks in your favorite order.

- 5** Press **RPT/ENT** until the PGM play starts.

### To check the program

#### During programming:

Press **RPT/ENT** repeatedly before step 5.

#### During the PGM play:

Press **PLAY MODE** repeatedly until “PGM” flashes, then press **RPT/ENT**.

Each time you press **RPT/ENT**, the track number appears.

#### Notes

- When you finish entering the 64th track in step 3, the first selected track appears in the display.
- If you select more than 64 tracks, the first selected tracks are erased.

## ► Available features

### G-PROTECTION function

The G-PROTECTION function has been developed to provide excellent protection against sound skipping while jogging. When you set the G-PROTECTION switch on your CD player to "2", the G-PROTECTION function will be enhanced compared to "1."

To walk with the CD player and enjoy high quality CD sound using the G-PROTECTION function, set the G-PROTECTION switch to "1." While taking harder exercise, it is recommended that you set it to "2."

**Set G-PROTECTION (under the lid) to "1" or "2."**

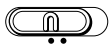

1 2  
G-PROTECTION

#### Note

Sound may skip:

- if the CD player receives stronger continuous shock than expected,
- if a dirty or scratched CD is played or
- when using poor-quality CD-Rs/CD-RWs or if there is a problem with the recording device or application software.

### Displaying CD text information

When you play a CD containing CD text information, the track name, disc name, artist name, etc., appear in the display.

#### Display on the remote control



"Track number" appears.

CD text appears in this portion.\*

\* While the CD player is reading the information on the CD, "READING" appears.

#### Press DISPLAY.

Each time you press the button, the display changes as follows:

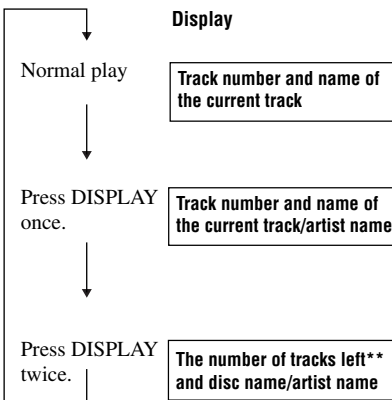

\*\* Not displayed during single play, shuffle play or PGM play.

#### Note

CD text displayed on this CD player is in English only.

## Checking the remaining time on the CD and the number of tracks left

You can check the remaining time on the CD and the number of tracks left using DISPLAY.

When playing a CD containing CD text information, you cannot use this function.

### Press DISPLAY.

Each time you press the button, the display changes as follows.

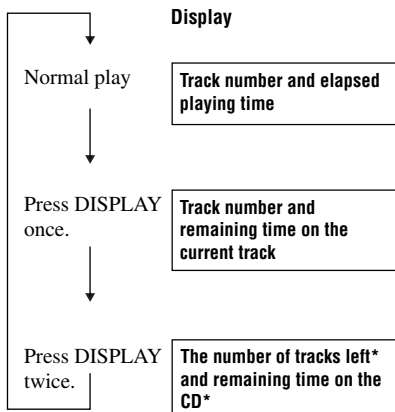

\* Not displayed during Single play, Shuffle play or PGM play.

## Emphasizing the bass sound (SOUND)

You can emphasize the bass-boosted sound.

Press SOUND to select “BASS 1” or “BASS 2.”

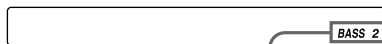
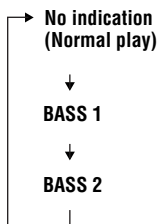

The selected sound mode is displayed.

“BASS 2” enhances the bass sound more than “BASS 1.”

### Note

If the sound is distorted when using the SOUND function, turn down the volume.

## Protecting your hearing

### (AVLS)

The AVLS (Automatic Volume Limiter System) function keeps down the maximum volume to protect your hearing.

Set AVLS (under the lid) to “LIMIT.”

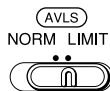

AVLS

Appears when the volume is turned up and beyond a certain level.

### To turn off the AVLS function

Set AVLS to “NORM.”

## Locking the controls

### (HOLD)

You can lock the controls on your CD player to prevent accidental button presses.

Slide **HOLD** in the direction of the arrow.

#### CD player



**CHARGE lamp flashes while the HOLD function is activated.**

#### Remote control



You can use the HOLD function with both the CD player and remote control. You can still operate your CD player using the remote control when HOLD on the remote control is set to off.

### To unlock the controls

Slide **HOLD** in the opposite direction of the arrow.

#### Note

Even if the HOLD function is working, “HOLD” will not appear in the display of the remote control.

---

## Turning off the operation beep sound

You can turn off the beep sound that is heard from your headphones/earphones when you operate your CD player.

---

**1** Remove the power source (AC power adaptor, rechargeable batteries or dry batteries) from the CD player.

---

**2** Connect the power source while pressing ■ (■/CHARGE for the CD player).

---

### To turn on the beep sound

Remove the power source and then connect the power source without pressing ■ or ■/CHARGE.

---

## Turning off the LCD's backlight

While you are using the rechargeable batteries or dry batteries, the LCD's backlight turns on for about 5 seconds every time you press a button. However, you can turn off the backlight to save the battery power.

---

**1** Remove the rechargeable batteries or dry batteries from the CD player.

---

**2** Insert the batteries while pressing PLAY MODE.

---

### To turn on the LCD's backlight

Remove the batteries and then insert the batteries without pressing PLAY MODE.

### About the LCD's backlight

The LCD's backlight is always turned on when using the AC power adaptor.



## ► Connecting your CD player

### Connecting a stereo system

You can listen to CDs through a stereo system and record CDs on a cassette tape and a MiniDisc. For details, see the instruction manual that comes with the connected device.

Be sure to turn off all connected devices before making connections.

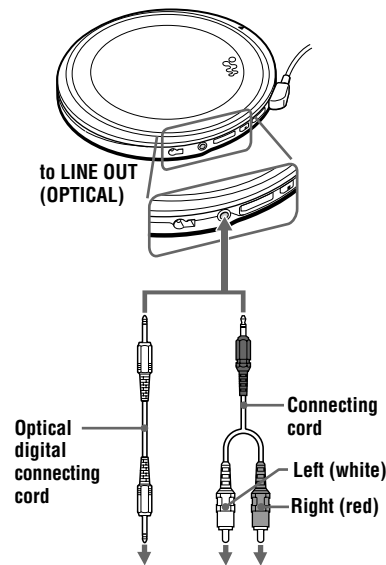

MiniDisc recorder, DAT deck, etc.

Stereo system, cassette recorder, radio cassette recorder, etc.

### Notes

- Before you play a CD, turn down the volume of the connected device to avoid damaging the connected speakers.
- Use the AC power adaptor for recording. If you use the rechargeable batteries or dry batteries as a power source, batteries may become completely depleted during recording.
- Adjust the volume properly on the connected device so that the sound will not be distorted.

### When using the connecting cord

If the sound is distorted, connect the device to the  jack.

### When using the optical digital connecting cord

To record a CD on a MiniDisc, DAT, etc., make sure that the CD player is in pause before operating the recording procedures.

### About the G-PROTECTION and SOUND functions when using the connecting cord or optical digital connecting cord

- To record high quality CD sound, set the G-PROTECTION switch to "1."
- The SOUND function works only on the output sound from the  jack and not work on the output sound from the LINE OUT (OPTICAL) jack.

(Continued)

---

## **Connecting a stereo system**

### **About Joint Text (CD text copying function)**

The Joint Text function allows you to copy the disc and track names that are on a CD containing CD text information. By connecting a Sony MD Walkman (MZ-R909), which supports Joint Text, to this CD player, you can copy the CD text onto an MD during recording. You must use an optical digital connecting cable (POC-5B or other model, not supplied) and the RK-TXT1 CD text connecting cable (not supplied) to make the connections.

For details, refer to the operating instructions of the MD Walkman.

## ► Connecting to a power source

You can use the following power sources:

- Rechargeable batteries
- AC power adaptor (see “Playing a CD”)
- LR6 (size AA) alkaline batteries (external battery case)

For the battery life and charging time of the rechargeable batteries, see “Specifications.”

## Using the rechargeable batteries

Charge the rechargeable batteries before using them for the first time. You can use only the following rechargeable batteries for your CD player.

- NH-14WM (A)

- 1** Open the battery compartment lid inside your CD player.

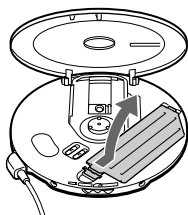

- 2** Insert two rechargeable batteries by matching the ⊕ to the diagram in the battery compartment and close the lid until it clicks into place.

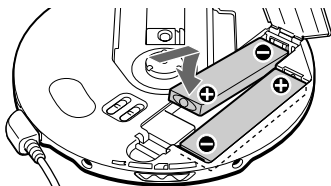

- 3** Connect the AC power adaptor to the DC IN 4.5 V jack of the supplied charging stand and an AC outlet. Then place the CD player on the supplied charging stand, aligning the ▼ mark on the CD player with the ▲ mark on the stand.

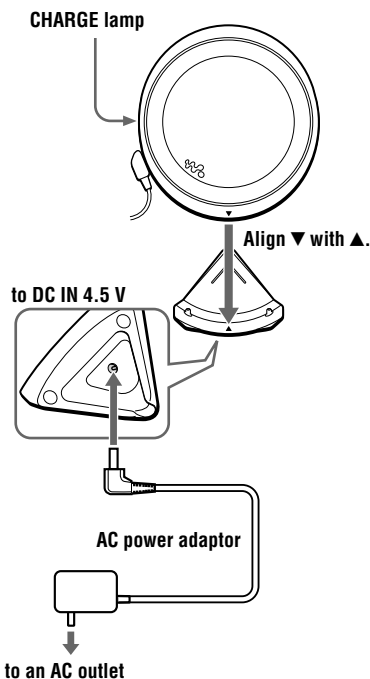

(Continued)

## Using the rechargeable batteries

Charging of the batteries starts.

In the display of the remote control, "Charging" indication flashes and the indicator sections of  light up in succession. The CHARGE lamp lights up on the CD player.

When the batteries are completely charged, all indications in the display disappear and the CHARGE lamp goes off.

## To charge the rechargeable batteries without using the supplied charging stand

Connect the AC power adaptor to the EXT BATT/DC IN 4.5 V jack of your CD player and an AC outlet, then press /CHARGE to start charging.

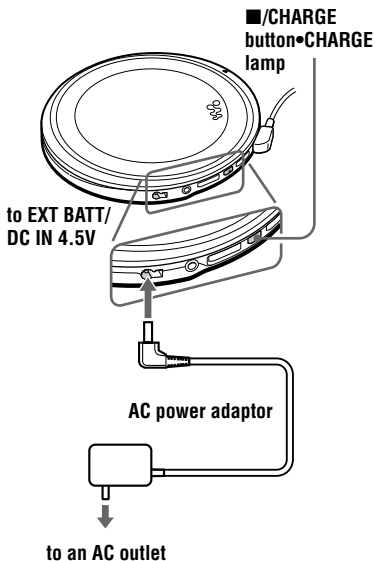

### Notes

- During charging, the CD player and the rechargeable batteries become hot. This poses no danger.
- If you press  during charging, charging stops and playback of the CD starts.
- If you place the CD player on the charging stand during playback, playback stops and charging starts.
- Place the CD player on the charging stand securely, aligning the ▼ mark on the CD player with the ▲ mark on the stand. Wrong placement interrupts charging or playback.

## To remove the rechargeable batteries

Push  $\ominus$  to remove the batteries.

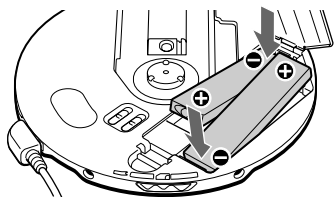

## When to charge the rechargeable batteries

You can check the remaining power of the batteries in the display.

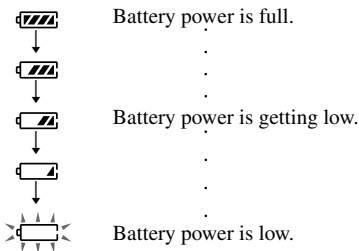



Lobatt\* Batteries are depleted.

\* Beep sounds.

To keep the original battery capacity for a long time, charge the batteries only when they are completely depleted.

### Notes

- The indicator sections of  roughly show the remaining battery power. One section does not always indicate one-fourth of the battery power.
- Depending on operating conditions, the indicator sections of  may increase or decrease.

## When to replace the rechargeable batteries

If the battery life becomes shorter by about half, replace the batteries with new rechargeable batteries.

## Note on the rechargeable batteries

If the battery is new or has not been used for a long time, it may not be charged completely until you charge and discharge it several times.

## Note on carrying the rechargeable batteries

Use the supplied battery carrying case to prevent unexpected heat. If the rechargeable batteries and the metallic objects are contacted, heat or fire may occur due to a short circuit.

## Notes on the supplied charging stand

- The supplied charging stand can be used only with this CD player. No other model can be charged using this stand.
- When using the supplied charging stand, charge the NH-14WM (A) rechargeable batteries only. Do not charge any other batteries.
- During charging, the CD player and the rechargeable batteries become hot. This poses no danger.
- Do not place coins or other metallic objects on the charging stand. If the terminals on the charging stand are accidentally brought into contact with a metallic object, they may short-circuit and begin to heat up.

## Using the dry batteries

Make sure to use the supplied external battery case.

Use only the following dry battery type for your CD player:

- LR6 (size AA) alkaline batteries

- 1** Unlock the cap of the external battery case, and insert two LR6 (size AA) alkaline batteries by matching the ⊕ to the diagram outside the external battery case and close the cap of the external battery case.

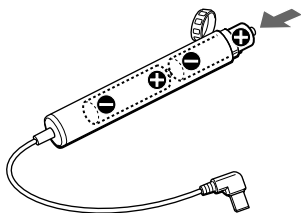

- 2** Connect the external battery case to the CD player.

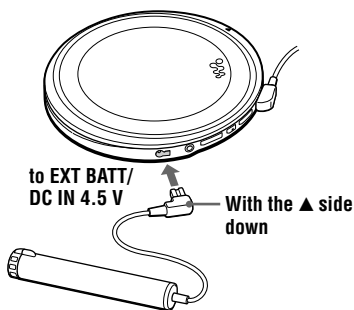

## When to replace the batteries

You can check the remaining power of the batteries in the display.

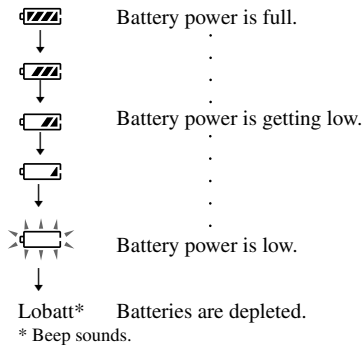

When the batteries are depleted, replace both batteries with new ones.

The batteries in the CD player and external battery case are discharged simultaneously.

### Notes

- Be sure to remove the AC power adaptor when attaching the external battery case.
- When using the rechargeable batteries and dry batteries together to extend power, use fully charged rechargeable batteries and new dry batteries.

## Notes on the power source

Disconnect all power sources when the CD player is not used.

### On AC power adaptor

- Use only the AC power adaptor supplied or recommended in “Accessories (supplied/ optional).” Do not use any other AC power adaptor. It may cause a malfunction.

#### Polarity of the plug



- When disconnecting the AC power adaptor from the AC outlet, grasp the adaptor itself. Do not pull it by the cord.
- Do not touch the AC power adaptor with wet hands.

### On rechargeable batteries and dry batteries

- Do not charge the dry batteries.
- Do not throw the batteries into fire.
- Do not carry the batteries with coins or other metallic objects. It can generate heat if the positive and negative terminals of the battery are accidentally contacted by a metallic object.
- Do not mix rechargeable batteries with dry batteries.
- Do not mix new batteries with old ones.
- Do not use different types of batteries together.
- When the batteries are not to be used for a long time, remove them.
- If battery leakage occurs, wipe off any deposit in the battery compartment, and install new batteries. In case the deposit adheres to you, wash it off thoroughly.

## Precautions

### On safety

- Should any solid objects or liquid fall into the CD player, unplug it and have it checked by qualified personnel before operating it any further.
- Do not put any foreign objects in the DC IN 4.5 V (external power input) jack.

### On the CD player

- Keep the lens on the CD player clean and do not touch it. If you do so, the lens may be damaged and the CD player will not operate properly.
- Do not put any heavy object on top of the CD player. The CD player and the CD may be damaged.
- Do not leave the CD player in a location near heat sources, or in a place subject to direct sunlight, excessive dust or sand, moisture, rain, mechanical shock, unlevelled surface, or in a car with its windows closed.
- If the CD player causes interference to the radio or television reception, turn off the CD player or move it away from the radio or television.
- Discs with non-standard shapes (e.g., heart, square, star) cannot be played on this CD player. Attempting to do so may damage the CD player. Do not use such discs.

### On handling CDs

- To keep the CD clean, handle it by its edge. Do not touch the surface.
- Do not stick paper or tape onto the CD.



- Do not expose the CD to direct sunlight or heat sources such as hot air ducts. Do not leave the CD in a car parked under direct sunlight.

## On headphones/earphones

### Road safety

Do not use headphones/earphones while driving, cycling, or operating any motorized vehicle. It may create a traffic hazard and is illegal in some areas. It can also be potentially dangerous to play your headsets at high volume while walking, especially at pedestrian crossings. You should exercise extreme caution or discontinue use in potentially hazardous situations.

### Preventing hearing damage

Avoid using headphones/earphones at high volume. Hearing experts advise against continuous, loud and extended play. If you experience a ringing in your ears, reduce volume or discontinue use.

### Consideration for others

Keep the volume at a moderate level. This will allow you to hear outside sounds and to be considerate to the people around you.

## Maintenance

### To clean the casing

Use a soft cloth slightly moistened in water or a mild detergent solution. Do not use alcohol, benzine or thinner.

### To clean the terminals

If the terminals on the charging stand or on the CD player become dirty, the batteries may not be charged properly. Clean the terminals with a cotton swab or a dry cloth periodically as illustrated below.

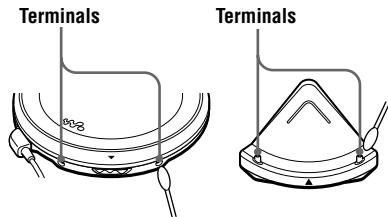





## Troubleshooting

Should any problem persist after you have checked these symptoms, consult your nearest Sony dealer.

Symptom	Cause and/or corrective actions
Cannot adjust the volume by turning the rotary control on the remote control.	→ Pull the rotary control in the direction of the arrow indicated on the control, then turn the control toward VOL + or -. (page 8)
Cannot start play by turning the rotary control on the remote control.	→ The rotary control is pulled out. Push the control back, then turn the control toward ►/►►. (page 8)
The volume does not increase even if you press the VOL + button repeatedly.	→ Set the AVLS switch to "NORM." (page 15) → The headphones/earphones are connected to the LINE OUT (OPTICAL) jack. Connect them to the ◌ (headphones) jack. (page 7)
Cannot adjust the volume.	→ The headphones/earphones are connected to the LINE OUT (OPTICAL) jack. Connect them to the ◌ (headphones) jack. (page 7)
No sound, or noise is heard.	→ Connect the plugs firmly. (page 7) → Plugs are dirty. Clean the plugs with a dry soft cloth periodically.
The playing time is too short when powered with the dry batteries.	→ Check that you are using alkaline batteries and not manganese batteries. (page 22) → Replace the batteries with new LR6 (size AA) alkaline batteries. (page 22)
The playing time is too short when powered with the rechargeable batteries.	→ Charge and discharge the rechargeable batteries several times. (pages 19 - 21)
"Lobatt" or "00" appears in the display. The CD does not play.	→ The rechargeable batteries are used up completely. Charge the batteries. (page 19) → Replace the batteries with new LR6 (size AA) alkaline batteries. (page 22)
"HiDCin" appears in the display.	→ Use only the AC power adaptor or car battery cord in "Accessories (supplied/optional)." (back cover) → Remove all power sources, then insert the batteries or connect the AC power adaptor again. (pages 7, 19, 22)
The CD does not play or "Nodisc" appears in the display when a CD is placed in the CD player.	→ The buttons are locked. Slide the HOLD switch back. (page 15) → The CD is dirty or defective. (page 24) → Check that the CD is inserted with the label side up. (page 7) → Moisture condensation has occurred. → Leave the CD player aside for several hours until the moisture evaporates. → Close the lid of the battery compartment firmly. (page 19) → Make sure the batteries are inserted correctly. (pages 19, 22) → Connect the AC power adaptor to an AC outlet securely. (page 7) → The CD-R/CD-RW was not finalized. Finalize the CD-R/CD-RW with the recording device. → There is a problem with the quality of the CD-R/CD-RW, recording device, or application software.

(Continued)

<b>Symptom</b>	<b>Cause and/or corrective actions</b>
<b>CHARGE lamp flashes when you press a button, the CD does not play.</b>	→ The buttons are locked. Slide the HOLD switch back. (page 15)
<b>Cannot adjust the volume with the VOL +/- buttons on the CD player.</b>	→ The CD player is connected to an audio device. Adjust the volume using the volume control on the connected device. (page 17)
<b>During recording with optical digital connection, the track number cannot be recorded correctly.</b>	→ Record the track number again using a MiniDisc recorder, DAT recorder, etc. (page 17) → See the instruction manual that comes with the recording device. (page 17)
<b>The rechargeable batteries cannot be charged.</b>	→ The terminals on the CD player or the charging stand are dirty. Wipe them with a dry cloth. → The CD is playing. Stop play. → The external battery case is connected to the CD player. Remove it and start charging again.
<b>Playback starts from the point you stopped. (resume function)</b>	→ The resume function is working. To start playing from the first track, turn the rotary control on the remote control toward  and hold it until the first track starts playing (press  for 2 seconds or more for the CD player), or open the lid of the CD player. Or, remove all power sources, then insert the batteries or connect the AC power adaptor again. (pages 7, 8, 19, 22)
<b>Rustling noise is heard from the CD.</b>	→ Close the lid of the battery compartment firmly. (page 19)
<b>When closing the lid of the CD player, the CD starts to rotate.</b>	→ The CD player is reading the information on the CD. It is not malfunctioning.
<b>You cannot operate the CD player properly using the remote control.</b>	→ The buttons on the CD player are kept pressed by mistake.

# Specifications

## System

Compact disc digital audio system

## Laser diode properties

Material: GaAlAs

Wavelength:  $\lambda = 780 \text{ nm}$

Emission duration: Continuous

Laser output: Less than  $44.6 \mu\text{W}$

(This output is the value measured at a distance of 200 mm from the objective lens surface on the optical pick-up block with 7 mm aperture.)

## D-A conversion

1-bit quartz time-axis control

## Frequency response

20 - 20 000 Hz  $_{-2}^{+1}$  dB (measured by JEITA CP-307)

## Output (at 4.5 V input level)

Line output (stereo minijack)

Output level 0.7 V rms at 47 k $\Omega$

Recommended load impedance over 10 k $\Omega$

Headphones (stereo minijack)

Approx. 5 mW + Approx. 5 mW at 16  $\Omega$

Optical digital output (optical output connector)

Output level: -21 - -15 dBm

Wavelength: 630 - 690 nm at peak level

## Power requirements

For the area code of the model you purchased, check the upper left side of the bar code on the package.

- Two Sony NH-14WM (A) rechargeable batteries: 2.4 V DC
- Two LR6 (size AA) batteries: 3 V DC
- AC power adaptor (DC IN 4.5 V jack):  
U/U2/CA2/E92/MX2/TW2/BR3 model:  
120 V, 60 Hz  
CED/CET/CEW/CEX/CE7/EE/EE1/E13/G5/  
G6/G7/G8/BR1 model: 220 - 230 V, 50/60 Hz  
CEK/3CE7 model: 230 - 240 V, 50 Hz  
AU2 model: 240 V, 50 Hz  
JE.W/E33/EA3/KR4 model: 100 - 240 V,  
50/60 Hz  
HK2 model: 220 V, 50/60 Hz  
AR1/CN2 model: 220 V, 50 Hz

## Battery life\* (approx. hours)

(When you use the CD player on a flat and stable surface.)

Playing time varies depending on how the CD player is used.

When using	G-PROTECTION	
	"1"	"2"
Two NH-14WM (A) (charged for about 5 hours**)	40	41
External battery case (two alkaline batteries***)	66	71
Rechargeable batteries NH-14WM (A) and external battery case (two alkaline batteries***)	108	115

\* Measured value by the standard of JEITA (Japan Electronics and Information Technology Industries Association).

\*\* Charging time varies depending on how the rechargeable battery is used.

\*\*\* When using Sony alkaline batteries LR6 (SG) (produced in Japan)

## Operating temperature

5°C - 35°C (41°F - 95°F)

## Dimensions (w/h/d) (excluding projecting parts and controls)

Approx. 127.0 × 136.2 × 13.9 mm

## Mass (excluding accessories)

Approx. 129 g

Design and specifications are subject to change without notice.

## Accessories (supplied/optional)

### Supplied accessories

For the area code of the location in which you purchased the CD player, check the upper left side of the bar code on the package.

- AC power adaptor (1)
- Headphones/earphones with remote control (1)
- Rechargeable batteries (2)
- Charging stand (1)
- Battery carrying case (2)
- Carrying pouch (1)
- External battery case (1)

### Optional accessories

Active speaker system	SRS-Z1 SRS-Z1000
Car battery cord	DCC-E345
Car battery cord with car connecting pack	DCC-E34CP
Car connecting pack	CPA-9C
Connecting cord	RK-G129 RK-G136
CD TEXT connecting cable	RK-TXT1
Optical digital connecting cord	POC-5B POC-10B POC-15B POC-5AB POC-10AB POC-15AB
Rechargeable battery	NH-14WM (A)
Earphones	MDR-E848LP MDR-EX70LP MDR-A44L MDR-A110LP

When you purchase an AC power adaptor, consult your nearest Sony dealer.

### When connecting optional headphones/earphones to the supplied remote control

Use only headphones with stereo mini plugs. You cannot use headphones with micro plugs.

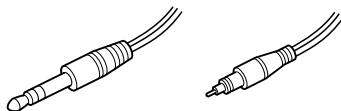

**Stereo miniplug**

**Micro plug**

Your dealer may not handle some of the accessories listed above. Please ask the dealer for detailed information about the accessories available in your country.

<http://www.world.sony.com/>

Sony Corporation