

# Portable MiniDisc Player

Operating Instructions

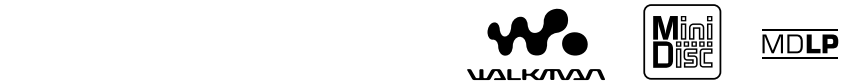

"WALKMAN" is a registered trademark of Sony Corporation to represent Headphone Stereo products. WALKMAN is a trademark of Sony Corporation.

## MZ-E610

Sony Corporation © 2003 Printed in Japan

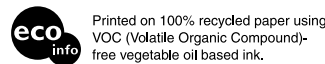

### WARNING

To prevent fire or shock hazard, do not expose the unit to rain or moisture.

Do not install the appliance in a confined space, such as a bookcase or built-in cabinet.

To prevent fire, do not cover the ventilation of the apparatus with newspapers, table-cloths, curtains, etc. And don't place lighted candles on the apparatus.

To prevent fire or shock hazard, do not place objects filled with liquids, such as vases, on the apparatus.

Certain countries may regulate disposal of the battery used to power this product. Please consult with your local authority.

**Caution**  
The use of optical instruments with this product will increase eye hazard.

**CAUTION** — INVISIBLE LASER RADIATION WHEN OPEN  
DO NOT STARE INTO BEAM OR VIEW DIRECTLY WITH OPTICAL INSTRUMENTS

**Information**  
IN NO EVENT SHALL SELLER BE LIABLE FOR ANY DIRECT, INCIDENTAL OR CONSEQUENTIAL DAMAGES OF ANY NATURE, OR LOSSES OR EXPENSES RESULTING FROM ANY DEFECTIVE PRODUCT OR THE USE OF ANY PRODUCT.

# Getting started

Charge the supplied rechargeable battery before using it for the first time.

## 1 Insert the rechargeable battery.

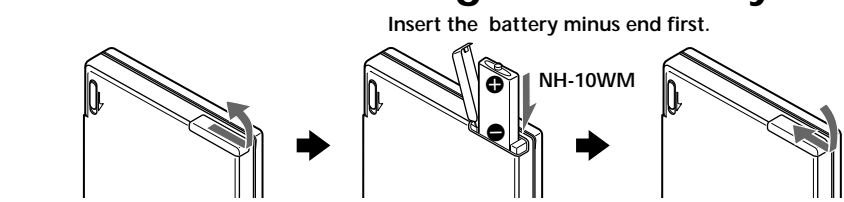

## 2 Charge the rechargeable battery.

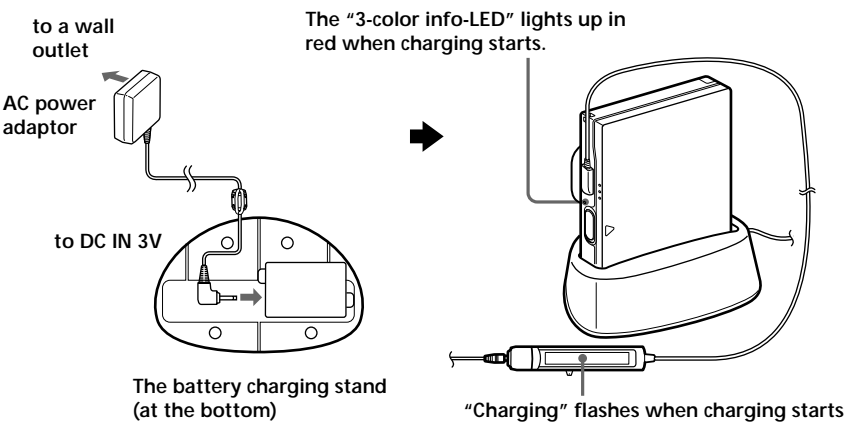

The battery condition is indicated by the "3-color info-LED" on the player:  
Red → Orange → LED off (approx. 2.5 hours later)  
The player can be used when the LED has turned off.

**Note**  
If you start playback or do another operation during charging, the charging will stop.

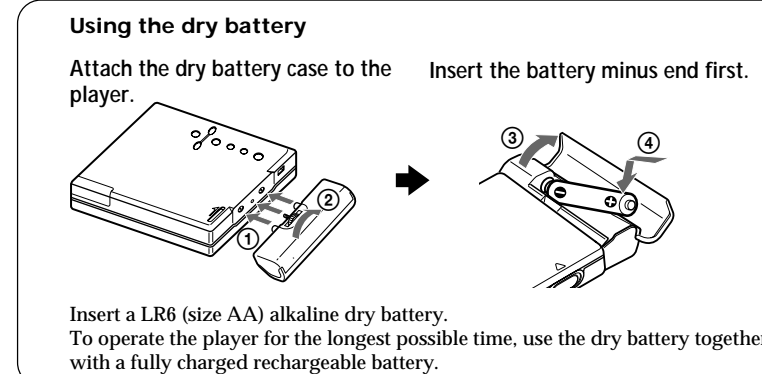

## 3 Make connections and unlock the controls.

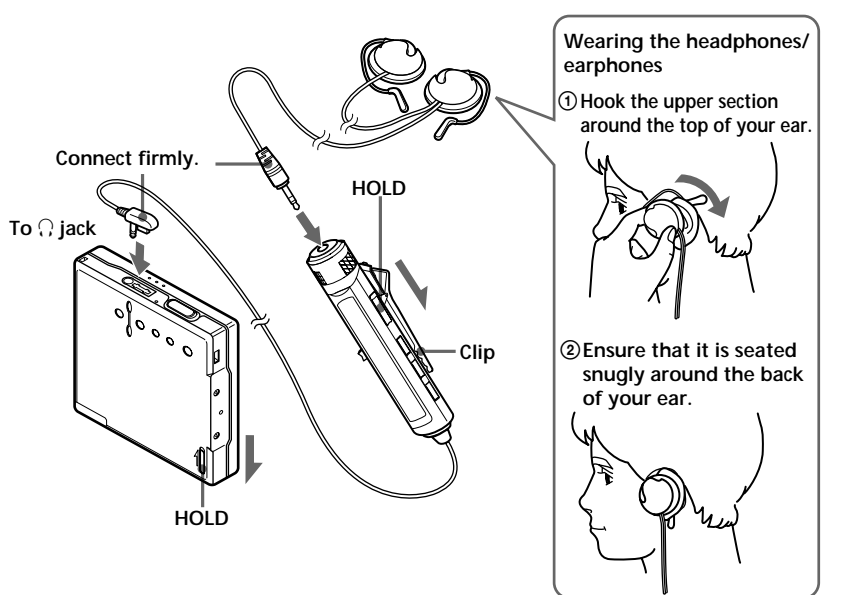

### Using the clip for the remote control

It may be hard for you to read the indications in the display if the remote control is attached upside down with the clip in its current position. In this case, attach the clip in the opposite direction as shown below.

- 1 Remove the clip.
- 2 Attach the clip in the opposite direction.

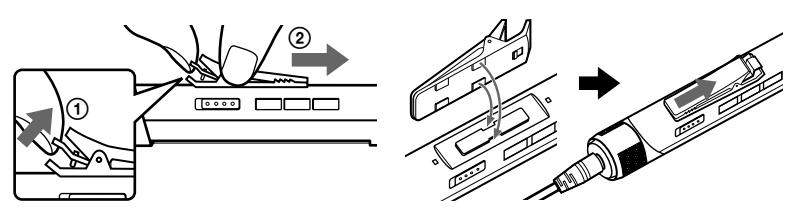

# Playing an MD

## 1 Insert an MD.

- 1 Slide OPEN to open the lid.
- 2 Insert an MD.
- 3 Close the lid.

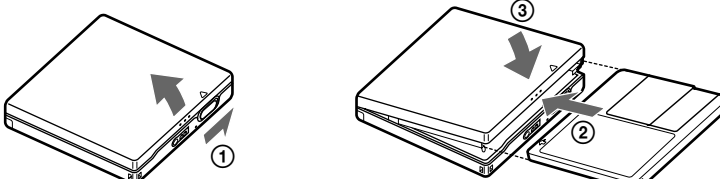

Insert an MD with the label side facing up, pushing the MD to the direction of the arrow in the illustration.

## 2 Play an MD.

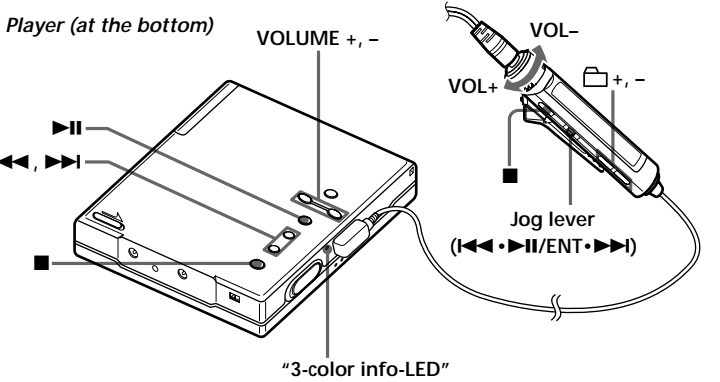

- 1 Press the jog lever (▶||) on the remote control. (Press ▶|| on the player.) A short beep sounds in the headphones/earphones. The LED lights up.
- 2 Turn the volume control towards VOL + or - on the remote control to adjust the volume. (Press VOLUME + or - on the player.) The volume indicator appears in the display, allowing you to check the volume level.

**To stop play, press ■.**  
A long beep sounds in the headphones/earphones. Playback starts from the point you last stopped playing. To start playback from the beginning of the disc, press and hold the jog lever (▶||) for 2 seconds or more on the remote control (Press and hold ▶|| for 2 seconds or more on the player).

| To  | Do this (Beeps in the headphones/earphones)  |
|---|--|
| Pause   | Press the jog lever (▶  ) on the remote control (continuous short beeps). (Press ▶   on the player.) Press the jog lever (▶   on the player) again to resume play. |
| Cue to the current track or the previous track  | Slide the jog lever towards ◀◀ or ▶▶ on the remote control (three short beeps). (Press ▶   on the player.)   |
| Cue to the next track   | Slide the jog lever towards ▶▶ on the remote control (two short beeps). (Press ▶▶ on the player.)  |
| Go backwards or forward while playing   | Slide and hold the jog lever towards ◀◀ or ▶▶ on the remote control. (Press and hold ◀◀ or ▶▶ on the player.)  |
| Searching for a specific position while viewing a elapsed time (Time search)                                      | While the player is paused, slide and hold the jog lever towards ◀◀ or ▶▶ on the remote control.   |
| Searching for a specific track while viewing track numbers (Index search)   | While the player is stopped, slide and hold the jog lever towards ◀◀ or ▶▶ on the remote control.  |
| Cue to the beginning of every 10th track (only during playback of the disc with no group settings <sup>1)</sup> ) | Press □ + or - button.   |
| Remove the MD   | Press ■, and then slide OPEN. <sup>2)</sup>  |

<sup>1)</sup> For more details, see "Using the group function."  
<sup>2)</sup> Once you open the lid, the point to start play will change to the beginning of the first track.

**About the "3-color info-LED"**  
The LED indicates the current operating mode, charging status, and battery condition. For details about the charging status, see "Getting started." For details about the battery condition, see "When to replace or recharge the battery" on the back page.

| LED color | Operating status                      |
|-----------|---------------------------------------|
| Red       | Playing a disc with no group settings |
| Green     | Playing a disc with group settings    |
| Orange    | Cueing to another group (Group Skip)  |

## Various ways of playback

Remote control

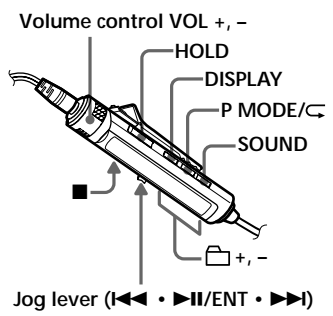

Player (at the bottom)

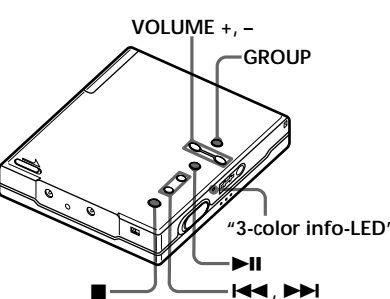

## Selecting the play mode

You can select from the various play modes using the P MODE/◀ button on the remote control.

- 1 Press P MODE/◀ repeatedly. Each time you press the button, the play mode changes as follows:  
Play mode indication

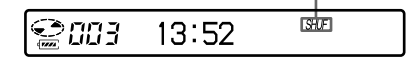

| Display* | Play mode   |
|----------|---|
| (none)   | All the tracks are played (normal play)                                     |
| 1        | A single track is played (single-track play)                                |
| 1        | Bookmarked tracks play back in order of their track number. (bookmark play) |
| SHUF     | All the tracks are played in random order. (shuffle play)                   |
| PGM      | The tracks are played in the order that you specified. (program play)       |

\* Group play mode (□) appears whenever you play a disc with group settings. For more details, see "Using the group function."

## Playing a track repeatedly (Repeat Play)

You can use the repeat function for normal play, single-track play, shuffle play, and program play mode.

- 1 During playback in the selected play mode, press and hold P MODE/◀ for 2 seconds or more. "◀" appears in the display. Repeat play indication

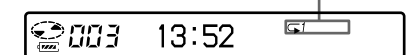

**To cancel repeat play**  
Press and hold P MODE/◀ for 2 seconds or more.

**Note**  
By pressing the P MODE/◀ button during repeat play, you can change the play mode to be used with repeat play.

## Listening to selected tracks only (Bookmark Play)

You can bookmark tracks on a disc and play them only. The sequence of bookmarked tracks cannot be changed.

**To bookmark the tracks**

- 1 While playing the track you want to bookmark, press and hold the jog lever for 2 seconds or more.

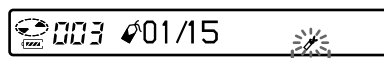

The first track for bookmark play is set.

- 2 Repeat step 1 to bookmark other tracks. You can bookmark with up to 15 tracks.

**To play the bookmarked tracks**

- 1 During playback, press P MODE/◀ repeatedly until "TRPLAY?" appears in the display.

- 2 Press the jog lever. The bookmarked tracks start playing, starting with the smallest track number.

**To erase a bookmark**

While playing the track for which you want to erase the bookmark, press and hold the jog lever for 2 seconds or more.

**Note**  
If you open the lid, all bookmarks are canceled.

## Listening to tracks in a desired sequence (Program Play)

- 1 During playback, press P MODE/◀ repeatedly until "PGM" appears in the display.

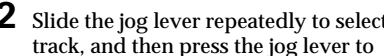

- 2 Slide the jog lever repeatedly to select a track, and then press the jog lever to enter that track.

- 3 Repeat step 2 to program more tracks. You can program up to 15 tracks.
- 4 After programming the tracks, press and hold the jog lever for 2 seconds or more. The program is stored and playback starts from the first track.

**Note**  
The program play settings will remain in memory even after playback finishes or is stopped.

**Note**  
All program settings are lost when the lid is opened.

## Using the group function

The group function is provided to allow playback of discs with group settings. The group function is convenient for playback of MDs on which several albums or CD singles have been recorded in MDLP (LP2/LP4) mode.

**What is a disc with group settings?**  
The player can play back tracks in units of groups; that is tracks that have been recorded on a disc as part of separate groups, as shown below. The "3-color info-LED" lights up in green when a disc with group settings is being played.

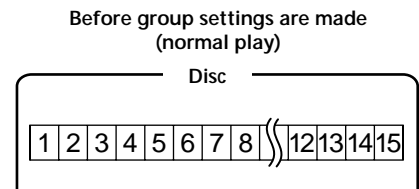

- 1 Track 1 to 5 are assigned to group 1.
- 2 Track 8 to 12 are assigned to group 2.
- 3 Track 13 to 15 are assigned to group 3.

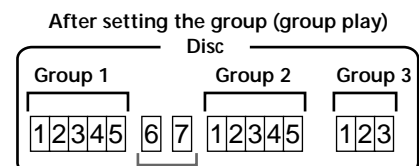

Tracks that were not assigned to a group are treated as being part of "Group -".

**Note**  
The player does not support the recording of group settings. Use an MD recorder to set the group. For details, see "Registering groups using an MD recorder."

## Playing a track in group play

In group play, all groups are played in order, starting with group 1, followed by the unassigned tracks ("Group -"). Playback stops after all the tracks have been played.

- 1 During playback, press P MODE/◀ repeatedly until "□" appears in the display.

## Cueing to the start of a group (Group Skip)

**On the remote control**

- 1 During playback, press □ + or -. Pressing the □ - button cues to the first track in the current group. Pressing the button again cues to the first track of the previous group. During group cueing, the "3-color info-LED" on the player flashes in orange.

**On the player**

- 1 During playback, press GROUP. The "3-color info-LED" on the player lights up in orange.
- 2 Press ◀◀ or ▶▶.

## Selecting the play mode for group play (Group Play Mode)

The shuffle play and program play function can be used during group play mode.

- 1 Press P MODE/◀ repeatedly. After normal playback, the following play modes are displayed:

| Display                   | Play mode   |
|---------------------------|---|
| □ (Normal Group Play)     | All tracks in the groups play back once (starting with the first track in group 1).                     |
| □ SHUF (In-Group Shuffle) | Shuffle play starts with the group that is currently playing, and continues with the succeeding groups. |
| □ PGM (Group Program)     | The groups are played in the order that you specified.  |

## Repeat play for the selected group play mode (Group Repeat Play)

- 1 During playback in the selected group play mode, press and hold P MODE/◀ for 2 seconds or more. Playback repeats in the respective group mode.

| Display  | Play mode                                    |
|----------|--|
| □ ◀      | Repeat play of tracks within a group         |
| □ SHUF ◀ | Repeat shuffle play of tracks within a group |
| □ PGM ◀  | Repeat play for group program                |

## Playing groups in a desired sequence (Group Program Play)

Do the procedure explained in "Listening to tracks in a desired sequence (Program Play)" to play back groups in a desired sequence. You can program up to 10 groups. The sequence of tracks within the groups cannot be changed.

## Registering groups using an MD recorder

An MD recorder with the group function Refer to the operating instructions of the MD recorder.

An MD recorder that does not support the group function The procedure below allows you to assign tracks to a group using the disc name-editing function.

## Specifying groups

- 1 Change the disc name to the following by using the MD recorder:

0:[Disc name]//[First track of group 1]  
Ⓐ Ⓑ  
[Last track of group 1] : [Name of group 1] //  
Ⓒ Ⓓ  
[First track of group 2] - [Last track of group 2] :  
Ⓔ Ⓕ  
[Name of group 2] // .....  
Ⓖ

Ⓐ Disc name  
Ⓑ Track number  
Ⓒ Group name  
// Separator between groups  
- Hyphen placed between the first track and the last track  
: Separator between track number and Group name

(Ex.) Set the following groups for the disc named "Collections":  
Group name for tracks 1-7:  
My Favorites"2002winter"  
Group name for tracks 8-17:  
Jun&Tac"sunshine head"  
Group name for tracks 18-24:  
THE NIGHT BUTTERFLYS  
Group name for tracks 25-32:  
Dream World/Kiss Me!

**Text string entered**  
0:Collections//  
1-7:My Favorites"2002winter"//  
8-17:Jun&Tac"sunshine head"//  
18-24:THE NIGHT BUTTERFLYS//  
25-32:Dream World/Kiss Me!//

**Note**  
• The characters ":", "/", and "-" can be used in a group name.  
• You can register the same group name more than twice on the same MD.  
• You can specify a group without entering a group name (Ⓒ) for it.

**Notes**  
• Up to 99 groups can be registered on a single MD. The actual number, however, will be less than 99 if you have entered more characters than are allowed per disc.  
• Depending on the specifications of your MD recorder, the group function may not work.

## Adjusting the sound (6-Band Equalizer)

You can select from 6 kinds of sound qualities.

- 1 During playback, press SOUND repeatedly to select "SOUND."
- 2 Press and hold SOUND for 2 seconds or more.
- 3 Slide the jog lever repeatedly to select the SOUND mode.

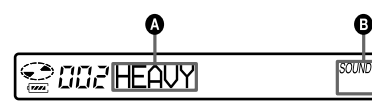

Each time you slide the jog lever, Ⓐ and Ⓑ change as follows:

| Ⓐ       | Ⓑ       |
|---------|---------|
| HEAVY   | SOUND H |
| POPS    | SOUND P |
| JAZZ    | SOUND J |
| UNIQUE  | SOUND U |
| CUSTOM1 | SOUND 1 |
| CUSTOM2 | SOUND 2 |

## To cancel the procedure

Press and hold the DISPLAY button or the ■ button for 2 seconds or more.

## To cancel the setting

Slide the jog lever repeatedly in step 1 above until the indication at Ⓒ disappears.

## To modify and store the sound

You can customize the sound settings in "CUSTOM1" and "CUSTOM2."

- 1 Do steps 1 to 3 above, and then slide the jog lever until "CUSTOM1" or "CUSTOM2" appears.
- 2 Press the jog lever.
- 3 Slide the jog lever repeatedly to select the frequency.



Frequency (100 Hz)  
From the left, you can select 100 Hz, 250 Hz, 630 Hz, 1.6 kHz, 4 kHz, or 10 kHz.

- 4 Turn the volume control repeatedly to adjust the level.

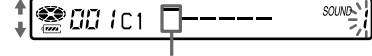

Level (+10 dB)  
You can select from among seven levels.  
-10 dB, -6 dB, -3 dB, 0 dB, +3 dB, +6 dB, +10 dB

- 5 Repeat steps 3 and 4 to adjust the level for each frequency.
- 6 Press the jog lever to enter the selection.

## Other operations

### Viewing the track name and playing time in the display on the remote control

You can check the track or disc name, track number, the elapsed playing time of the current track, the number of the tracks recorded on the MD, the group name, and the total number of tracks in a group.

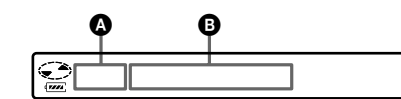

- 1 Press DISPLAY on the remote control. Each time you press DISPLAY, the display changes as follows:

| Ⓐ                                       | Ⓑ                |
|---|------------------|
| Track number                            | The elapsed time |
| Track number                            | Track name       |
| The number of total tracks in the group | Group name       |
| The number of total tracks              | Disc name        |
| Track number                            | Sound mode       |
| Track number                            | SP/LP mode       |

### Notes

• Depending on whether group play or normal play is selected, the operating conditions, and the disc settings, you may not be able to select certain indications or the indications may appear different.  
• During playback, the SP/LP mode appears momentarily, and is then replaced by the elapsed time of the current track.

## Suppressing the skips of the sound (G-PROTECTION)

The G-PROTECTION function was developed to provide a higher level of shock resistance than that of existing players in order to allow the player to be used while jogging.

### Note

The playback sound may skip if:  
• The player receives stronger continuous shock.  
• A dirty or scratched MiniDisc is played.

## ▶Other operations (continued)

### Remote control

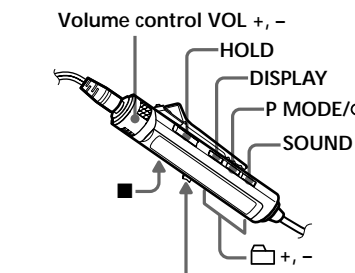

Jog lever (◀◀ ▶▶/ENT/▶▶▶)

### Player (at the bottom)

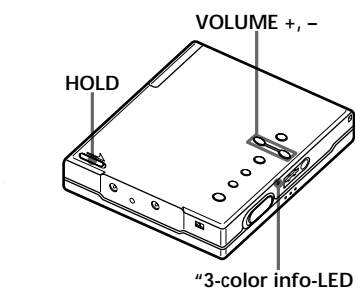

## Starting playback quickly (Quick Mode)

After pressing the playback button or cueing to a track, you can start playback quickly. This procedure can be done by the remote control.

- 1 Press and hold DISPLAY for 2 seconds or more.

- 2 Slide the jog lever repeatedly until "PowerMode" appears in the display, and then press the jog lever.

- 3 Slide the jog lever repeatedly until "QUICK" appears in the display, and then press the jog lever to enter the selection. "QUICK" appears in the display.

### To cancel the procedure

Press and hold the DISPLAY button or the ■ button for 2 seconds or more.

### To cancel the setting

Select "NORMAL" in step 3 above.

### Notes

- When the power mode is set to "QUICK," the power remains on within the player even when nothing appears in the display. This leads to a shorter battery life. For this reason, it is recommended that you charge the battery daily.
- If no player operation (including opening or closing of the lid) occurs for 17 hours, the power in the player automatically turns off. For this reason, the next time you start playback or do another operation, the player will not respond quickly. The unit, however, will return to quick mode afterwards.

## Protecting your hearing (AVLS)

AVLS (Automatic Volume Limiter System) function keeps down the maximum volume to protect your ears.

- 1 During playback, press and hold DISPLAY for 2 seconds or more.

- 2 Slide the jog lever repeatedly until "AVLS" appears in the display, and then press the jog lever.

- 3 Slide the jog lever repeatedly until "AVLS ON" appears in the display, and then press the jog lever to enter the selection. "AVLS ON" appears in the display.

### To set the AVLS function on the player

During playback, slide HOLD in the direction of ➡, and then while pressing VOLUME -, slide HOLD in the opposite direction.

- 1 Press and hold DISPLAY for 2 seconds or more.
- 2 Slide the jog lever repeatedly until "PowerMode" appears in the display, and then press the jog lever.
- 3 Slide the jog lever repeatedly until "AVLS OFF" appears in the display, and then press the jog lever to enter the selection. "AVLS OFF" appears in the display.

## Turning off the beep sound

You can set the beep so that it is not emitted when the player and the remote control are operated. This procedure can be done by the remote control.

- 1 Press and hold DISPLAY for 2 seconds or more.

- 2 Slide the jog lever repeatedly until "BEEP" appears in the display, and then press the jog lever.

- 3 Slide the jog lever repeatedly until "BEEP OFF" appears in the display, and then press the jog lever to enter the selection.

### To cancel the procedure

Press and hold the DISPLAY button or the ■ button for 2 seconds or more.

### To cancel the setting

Select "BEEP ON" in step 3 above.

## Turning on/off the backlight in the display on the remote control

You can set the backlight in the display on the remote control. This procedure can be done by the remote control.

- 1 Press and hold DISPLAY for 2 seconds or more.

- 2 Slide the jog lever repeatedly until "BACKLIGHT" appears in the display, and then press the jog lever.

- 3 Slide the jog lever repeatedly to select one of the following settings:

| Display Setting |  |
|-----------------|--|
| AUTO            | The backlight lights when you operate the player or the remote control, and automatically turns off when no operation is made for a while (factory setting). |
| ON              | The backlight lights while the player is operating.  |
| OFF             | The backlight stays off.   |

- 4 Press the jog lever to enter the setting.

## Locking the controls (HOLD)

- 1 Slide HOLD on the remote control in the ➡ direction, and slide HOLD on the player in the ➡ direction. Sliding HOLD on the remote control disables the controls on the remote control. Sliding HOLD on the player disables the controls on the player.

### To unlock the controls

Slide HOLD to the opposite directions of the arrows.

## Preserving battery power (Power Save Mode)

This function allows you to maximize the operating life of the battery. Power consumption is reduced by turning off the "3-color info-LED" at all times, or by turning off the display when no operation has been made for a while. This procedure can be done by the remote control.

- 1 Press and hold DISPLAY for 2 seconds or more.
- 2 Slide the jog lever repeatedly until "PowerMode" appears in the display, and then press the jog lever.

- 3 Slide the jog lever repeatedly until "PowerSave" appears in the display, and then press the jog lever to enter the selection. The "3-color info-LED" turns off.

### To cancel the procedure

Press and hold the DISPLAY button or the ■ button for 2 seconds or more.

### To turn on the "3-color info-LED"

Select "NORMAL" in step 3 above.

## ▶Power sources

## When to replace or recharge the battery

You can check the battery condition through the battery indicator on the remote control and the "3-color info-LED" on the player while using the player.

### Indicator on the remote control

|  |  |
|--|--|
|  | Battery power decreasing   |
|  | Weak battery   |
|  | The battery has gone out. "LOW BATT" flashes in the display, and the power goes off. |

### Indicator of the "3-color info-LED" on the player

|  |   |
|--|---|
|  | There is sufficient battery power.  |
|  | Battery power decreasing  |
|  | The battery is low. The LED will soon turn off and the supply of power will stop. |

### Notes

- The battery indicator may show the battery to be fully charged even when it is not. Charging the battery shorter than the prescribed time will result in a shorter operating time on the player.
- A stronger or weaker battery charge may be indicated when you fast forward or fast reverse an MD, or when you use the player at a very cold place.

### Battery life<sup>1)</sup>

| Batteries  | (Unit: Approx. hours) (JEITA <sup>2)</sup> ) |            |            |
|--|--|------------|------------|
|  | SP Stereo LP2 (normal)                       | LP4 Stereo | LP4 Stereo |
| Ni-MH rechargeable battery NH-10WM <sup>3)</sup> | 26   | 32         | 42         |
| LR6 (SG)   | 57   | 72         | 91         |
| LR6 (SG) <sup>4)</sup> and NH-10WM <sup>3)</sup> | 85   | 107        | 130        |

<sup>1)</sup> Measured with the power save function on (see "Preserving battery power").

<sup>2)</sup> Measured in accordance with the JEITA (Japan Electronics and Information Technology Industries Association) standard (using a Sony MDW-series Mini-disc).

<sup>3)</sup> With a fully charged battery

<sup>4)</sup> When using a Sony LR6 (SG) "STAMINA" alkaline dry battery (produced in Japan).

### Note

The battery life may be shorter than that specified, depending on the temperature of the location, the operating conditions, and the type of battery being used.

## Using house current

You can operate the player without a rechargeable battery or a dry battery. To do this, connect the battery charging stand to an AC outlet through the AC power adaptor, and then place the player on the stand.

## ▶Additional information

## Precautions

### On safety

- Make sure to keep the player in the supplied carrying pouch. If the terminals on the player, battery-charging stand, or battery case are accidentally brought into contact with a metallic object, they may short-circuit and begin to heat up.
- Keep the terminals on the player or on the battery case away from metallic objects or surfaces. Such contact may short-circuit the terminals and cause dangerous heat generation. When carrying the player with you, always keep the battery case attached to the player in the supplied carrying pouch.
- When you carry the supplied rechargeable battery, be sure to put it in the supplied rechargeable battery carrying case. Carrying the rechargeable battery without the case may cause a short-circuit with metallic objects such as coins, key rings, or necklaces. As a result, heat may be generated.
- Do not put any foreign objects in the DC IN 3V jack.
- Do not carry or store the dry battery or battery case in the same place with metallic objects such as coins, key rings, or necklaces. This may cause a short-circuit and the generation of heat.
- Incorrect battery usage may cause the battery fluid to leak or the battery to burst. To prevent such accidents, observe the following precautions:
  - Install battery with the + and - poles aligned correctly.
  - Do not charge dry battery.
- If a battery leak should develop, carefully and thoroughly wipe away the battery fluid in the battery compartment before inserting a new battery.
- If you will not use the player for a long time, be sure to disconnect the power supply (AC power adaptor, dry battery, rechargeable battery, or battery charging stand). When disconnecting the AC power adaptor from the electrical outlet, grasp the adaptor plug itself; never pull the cord.

### On the MiniDisc cartridge

- Do not touch the internal disc directly. Forcing the shutter open may damage the internal disc.
- When transporting a minidisc, keep it in its case.
- Do not place the cartridge where it will be subjected to light, temperature, moisture or dust.
- Do not affix the label outside of the specified area on the MD. Make sure the label is placed within the recessed space on the disc.

### On the headphones/earphones

- Do not use headphones/earphones while driving, cycling, or operating any motorized vehicle. This may lead to a traffic accident and is illegal in many areas. It can also be potentially dangerous to play your player at high volumes while walking, especially at pedestrian crossings. You should exercise extreme caution or discontinue using the player in potentially hazardous situations.
- If you experience an allergic reaction to the supplied headphones/earphones, stop using them at once and consult a doctor or a Sony service center.

### Preventing hearing damage

Avoid using headphones/earphones at high volumes. Hearing experts advise against continuous, loud and extended play. If you experience a ringing in your ears, reduce the volume or discontinue use.

### Caring for others

Keep the volume at a moderate level. This will allow you to hear outside sounds and to be considerate of the people around you.

### On the battery case

The supplied battery case is designed for use with the MZ-E610 only.

### On cleaning

- After wiping the player casing with a soft cloth slightly moistened with water, wipe it again with a dry cloth. Do not use any type of abrasive pad, scouring powder or solvent such as alcohol or benzene as this may mar the finish on the casing.
- Wipe the disc cartridge with a dry cloth to remove dirt.
- Dust on the lens may prevent the unit from operating properly. Be sure to close the disc compartment lid after inserting or ejecting an MD.
- To maintain good sound quality, use a soft cloth to clean the plugs of the headphones/earphones and remote control. A dirty plug may cause noise or intermittent breaks in the sound during playback.

- Clean the terminals periodically with a cotton swab or a soft cloth as illustrated.

## Rechargeable battery compartment

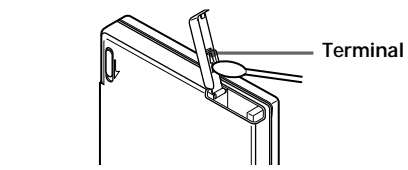

### Dry battery case

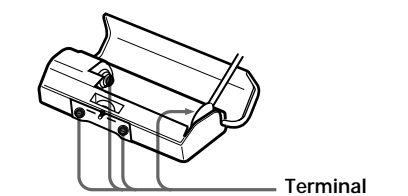

## Rechargeable battery (supplied)/ Dry battery (not supplied)

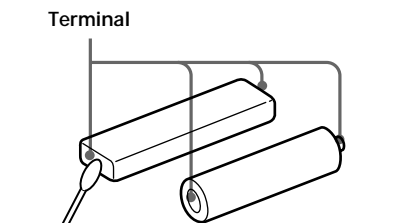

## Battery charging stand

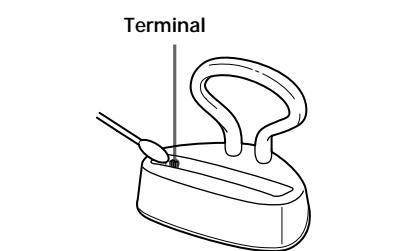

If you have any questions or problems concerning your player, please consult your nearest Sony dealer. (If a trouble occurred when the disc was in the player, we recommend that the disc be left in the player when you consult your Sony dealer so that the cause of trouble may be better understood.)

## Troubleshooting

The rechargeable battery does not start charging.

- The terminals of the battery charging stand are dirty.
  - ➡ Wipe the terminals with a dry cloth.
- The rechargeable battery is not inserted in the player.
  - ➡ Insert the rechargeable battery into the player.

- The surrounding temperature is too high or too low ("CannotCHG" appears in the display when the surrounding temperature is too high, or "SLOW CHG" when temperature is too low).
  - ➡ Charge the battery at a temperature of +5°C (+41°F) to +40°C (+104°F).

The "3-color info-LED" does not light up even when the player is placed on the battery charging stand.

- The rechargeable battery is not inserted in the player.
  - ➡ Insert the rechargeable battery into the player.

- The LED may not light on immediately after you placed the player on the battery charging stand.
  - ➡ The LED will light up after about 3 minutes and charging will begin.

The player does not work or works poorly.

- The rechargeable battery or dry battery has been installed incorrectly.
  - ➡ Install the battery with correct polarity.

- You tried to play with no disc in the player ("NO DISC" appears on the remote control).
  - ➡ Insert an MD.

- The hold function is activated and the controls are locked. (If you press any of the operation buttons on the player, "HOLD" appears on the remote control).
  - ➡ Slide HOLD in the opposite direction of the arrow to release the hold function.

- You pressed on a button on the player while making a setting on the remote control. ("MENU" appears on the remote control when a button on the player is pressed).
  - ➡ End the setting procedure using the remote control.

- Moisture has condensed inside the player.
  - ➡ Take the MD out and wait for several hours until the moisture has evaporated.

- The rechargeable battery or dry battery is weak ("LOW BATT" appears on the remote control).
  - ➡ Insert a new dry battery or recharge the battery.

- An MD with nothing recording on it is inserted ("BLANKDISC" appears on the remote control).
  - ➡ Insert a recorded MD.

- The player cannot read the disc. (It's scratched or dirty) ("READ ERR" or "TOC ERR" appears on the remote control).
  - ➡ Reinsert or replace the disc.

- While operating, the player received a mechanical shock, too much static, abnormal power voltage caused by lightning etc.
  - ➡ Restart the player as follows:

- 1 Disconnect the power source.
- 2 Let the player sit for about 30 seconds.
- 3 Reconnect the power source.

There is no sound output from the headphones/earphones.

- The headphones/earphones plug is not firmly inserted.
  - ➡ Insert the headphones/earphones plug firmly to the remote control.
  - ➡ Insert the headphones/earphones plug firmly into the ♂ jack.

- AVLS is on.
  - ➡ Cancel the AVLS function. For more details, see "Protecting your hearing."

The MD does not play normally.

- The player is set to the repeat mode.
  - ➡ Press and hold the P MODE/C button on the remote control until "C" disappears, then start playing.

The MD does not play from the first track.

- The disc stopped playing before reaching the last track.
  - ➡ Open the lid or when the player stops, press and hold the jog lever for 2 seconds or more to start playing from the first track.

### The playback sound skips.

- The player is placed where it receives continuous vibration.
  - ➡ Place the player at a stable place.
- A very short track may cause sound to skip.

The sound has a lot of static.

- Strong magnetism from a television or other device causing interference.
  - ➡ Move the player away from the source of strong magnetism.

### Noise is momentarily heard.

- The sound was recorded in LP4 stereo mode.
  - ➡ Because of the nature of the compression method used in LP4 mode, noise may be output on very rare occasions during playback of sound recorded in this mode.

During playback, the "3-color info-LED" or display on the remote control does not turn on.

- Power save mode is activated.
  - ➡ In power save mode, the display on the remote control turns on whenever the remote control is operated, but not when the controls on the player are operated. (The exception is when the GROUP button on the player is pushed.)

### The group function does not function.

- A disc that has no group settings is inserted.
  - ➡ Insert a disc with group settings.

Bookmark play on the player is not possible. ("NoEntry" appears in the display on the remote control.)

- You tried to select bookmark play without setting bookmarks.
  - ➡ Set bookmarks.

## Specifications

Audio playing system  
MiniDisc digital audio system  
Laser diode properties  
Material: GaAlAs  
Wavelength: λ = 790 nm  
Emission duration: continuous  
Laser output: less than 44.6 μW  
\* This output is the value measured at a distance of 200 mm from the objective lens surface on the optical pick-up block with 7 mm aperture.  
Revolutions  
Approx. 300 rpm to 2,700 rpm  
Error correction  
ACIRC (Advanced Cross Interleave Reed Solomon Code)  
Sampling frequency  
44.1 kHz  
Coding  
ATRAC (Adaptive TRansform Acoustic Coding)  
ATRAC3: LP2/LP4  
Modulation system  
EFM (Eight to Fourteen Modulation)  
Number of channels  
2 stereo channels  
1 monaural channel  
Frequency response  
20 to 20,000 Hz ± 3 dB  
Outputs  
Headphones/earphones: stereo mini-jack, Maximum output level 5 mW + 5 mW load impedance 16 Ω

Power requirements  
Nickel metal hydride rechargeable battery  
One NH-10WM (supplied): 1.2 V, 900 mAh (MIN)  
One LR6 (size AA) battery (not supplied)

External power jack (for the battery charging stand): Power rating 3V DC  
Battery operation time  
See "When to replace or recharge the battery"

Dimensions  
Approx. 73.4 × 80.6 × 15.7 mm (w/h/d) (3 × 3 1/4 × 5/8 in.) (not including projecting parts and controls)  
Mass  
Pink color player: Approx. 70 g (2.47 oz) (the player only)  
White color player: Approx. 72 g (2.54 oz) (the player only)  
Supplied accessories  
Headphones/earphones with a remote control (1)  
Battery charging stand (1)  
AC power adaptor (for the supplied battery charging stand) (1)  
Rechargeable battery (1)  
Rechargeable battery carrying case (1)  
Dry battery case (1)  
Carrying pouch (1)

US and foreign patents licensed from Dolby Laboratories.

Design and specifications are subject to change without notice.

### Optional accessories

AC power adaptor  
AC-E30L  
NH-10WM Nickel metal hydride rechargeable battery  
MDS series stereo headphones/earphones\*  
SRS series Active Speakers

- \* Whether you should plug the headphones/earphones directly to the ♂ jack on the main unit or to a remote control, use only headphones/earphones with stereo mini plugs. Headphones/earphones with a microplug cannot be used.

Your dealer may not handle some of the above listed accessories. Please ask the dealer for detailed information about the accessories in your country.

## Parts and controls

### The Player

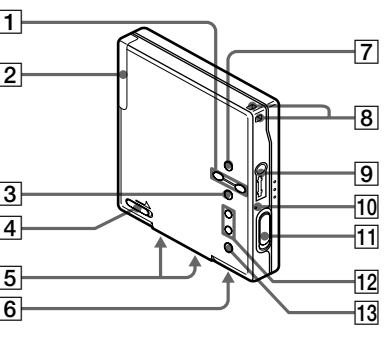

- 1 VOLUME +/-, - buttons
- 2 Battery compartment
- 3 ►| button
- 4 HOLD (Locking the control) switch
- 5 Terminals for dry battery case (at the bottom)
- 6 Terminals for charging stand (at the bottom)
- 7 GROUP button
- 8 Hand strap hole  
Use the hole to attach your strap.
- 9 ♂ (headphones/earphones) jack
- 10 "3-color info-LED"
- 11 OPEN switch
- 12 ◀◀ ▶▶ button
- 13 ■ button

\* VOLUME + and ►| have a tactile dot.

### The display window of the remote control

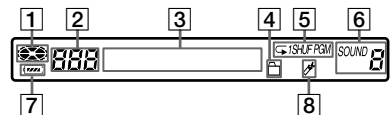

- 1 Disc indication
- 2 Track number display
- 3 Character information display
- 4 Group play indication
- 5 Play mode indication
- 6 8-band equalizer indications
- 7 Battery level indication
- 8 Bookmark indication

### The battery charging stand

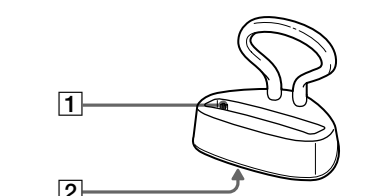

- 1 Terminals for charging
- 2 DC IN 3V jack (at the bottom)

### The headphones/earphones with a remote control

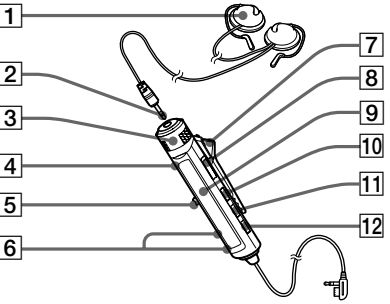

- 1 Headphones/earphones
- 2 Stereo mini plug
- 3 Volume control VOL +/-, -  
Turn to adjust the volume.
- 4 ■ (stop) button
- 5 Jog lever (◀◀ ▶▶/ENT/▶▶▶) button
- 6 ☐ (Group) +, - button
- 7 Clip
- 8 HOLD switch
- 9 Display window
- 10 DISPLAY button
- 11 P MODE/C (play mode/repeat) button
- 12 SOUND button