

SONY[®]

3-293-639-11(1)

Micro HI-FI Component System

Operating Instructions
CMT-BX30R



WARNING

To reduce the risk of fire, do not cover the ventilation opening of the apparatus with newspapers, tablecloths, curtains, etc. Do not place the naked flame sources such as lighted candles on the apparatus.

To reduce the risk of fire or electric shock, do not expose this apparatus to dripping or splashing, and do not place objects filled with liquids, such as vases, on the apparatus.

As the main plug is used to disconnect the unit from the mains, connect the unit to an easily accessible AC outlet. Should you notice an abnormality in the unit, disconnect the main plug from the AC outlet immediately.

Do not install the appliance in a confined space, such as a bookcase or built-in cabinet.

Do not expose batteries or apparatus with battery-installed to excessive heat such as sunshine, fire or the like.

CAUTION

The use of optical instruments with this product will increase eye hazard.

Latin American models only except for the Argentine model

The nameplate is located on the bottom exterior.

Except for customers in the U.S.A. and Canada

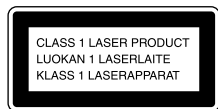

This appliance is classified as a CLASS 1 LASER product. For Latin American models only except for the Mexico and Argentine models, this marking is located on the bottom exterior. For other models, this marking is located on the rear exterior.

European model only

Excessive sound pressure from earphones and headphones can cause hearing loss.

Notice for the customer in the countries applying EU Directives.

The manufacturer of this product is Sony Corporation, 1-7-1 Konan Minato-ku, Tokyo, 108-0075 Japan. The Authorized Representative for EMC and product safety is Sony Deutschland GmbH, Hedelfinger Strasse 61, 70327 Stuttgart, Germany. For any service or guarantee matters, please refer to the addresses given in separate service or guarantee documents.



Disposal of Old Electrical & Electronic Equipment (Applicable in the European Union and other European countries with separate collection systems)

This symbol on the product or on its packaging indicates that this product shall not be treated as household waste. Instead it shall be handed over to the applicable collection point for the recycling of electrical and electronic equipment. By ensuring this product is disposed of correctly, you will help prevent potential negative consequences for the environment and human health, which could otherwise be caused by inappropriate waste handling of this product. The recycling of materials will help to conserve natural resources. For more detailed information about recycling of this product, please contact your local Civic Office, your household waste disposal service or the shop where you purchased the product.

Applicable accessories: Remote commander



Disposal of waste batteries (applicable in the European Union and other European countries with separate collection systems)



Pb

This symbol on the battery or on the packaging indicates that the battery provided with this product shall not be treated as household waste. By ensuring these batteries are disposed of correctly, you will help prevent potentially negative consequences for the environment and human health which could otherwise be caused by inappropriate waste handling of the battery. The recycling of the materials will help to conserve natural resources. In case of products that for safety, performance or data integrity reasons require a permanent connection with an incorporated battery, this battery should be replaced by qualified service staff only. To ensure that the battery will be treated properly, hand over the product at end-of-life to the applicable collection point for the recycling of electrical and electronic equipment.

For all other batteries, please view the section on how to remove the battery from the product safely. Hand the battery over to the applicable collection point for the recycling of waste batteries.

For more detailed information about recycling of this product or battery, please contact your local Civic Office, your household waste disposal service or the shop where you purchased the product.

Note on DualDiscs

A DualDisc is a two sided disc product which mates DVD recorded material on one side with digital audio material on the other side. However, since the audio material side does not conform to the Compact Disc (CD) standard, playback on this product is not guaranteed.

Music discs encoded with copyright protection technologies

This product is designed to playback discs that conform to the Compact Disc (CD) standard. Recently, various music discs encoded with copyright protection technologies are marketed by some record companies. Please be aware that among those discs, there are some that do not conform to the CD standard and may not be playable by this product.

- “WALKMAN” and “WALKMAN” logo are registered trademarks of Sony Corporation.
- MPEG Layer-3 audio coding technology and patents licensed from Fraunhofer IIS and Thomson.
- Windows Media is a registered trademark of Microsoft Corporation in the United States and/or other countries.

Table of Contents

Guide to parts and controls	5
Information on the display	9

Getting Started

Hooking up the system securely	10
Setting the clock	12

Basic Operations

Playing a CD/MP3 disc	13
Listening to the radio	14
Recording from a disc onto an USB device	15
Listening to music of an USB device	18
Using optional audio components	20
Adjusting the sound	21
Changing the display	21

Other Operations

Creating your own program (Program Play)	22
Presetting radio stations	23
Using the Timers	24

Others

Troubleshooting	25
Messages	30
Precautions	31
Specifications	32
Compatible USB devices with this system	34

Guide to parts and controls

This manual mainly explains operations using the remote, but the same operations can also be performed using the buttons on the unit having the same or similar names.

Unit

Front panel

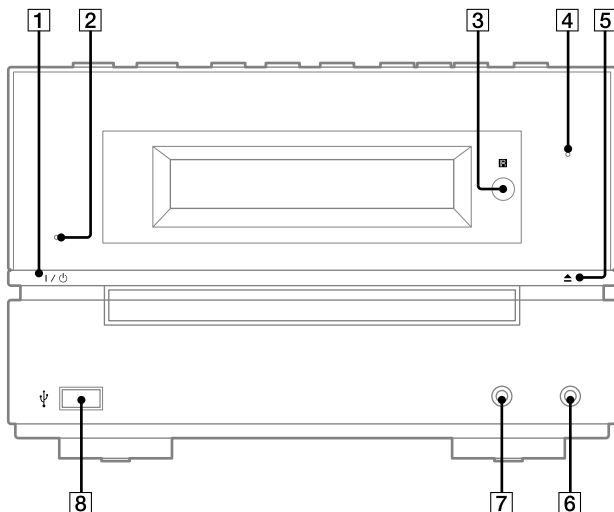

Top panel

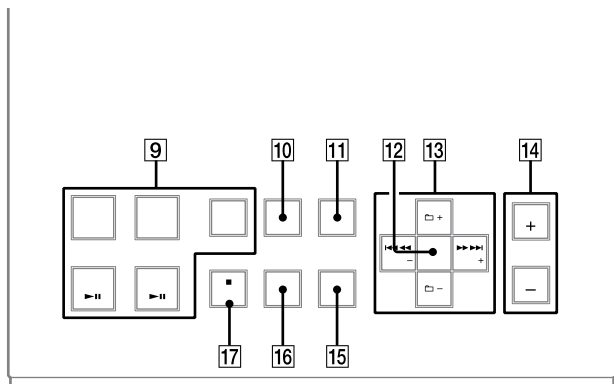

Remote

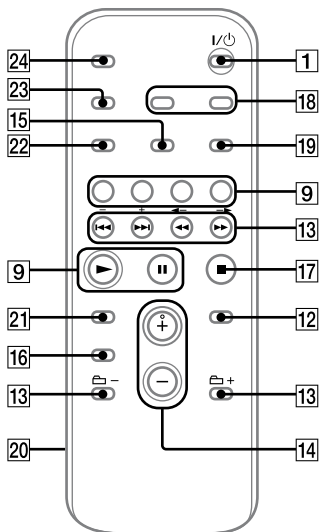

1
I/O (power) button (page 12, 24, 29)

Press to turn on the system.

2
STANDBY indicator (page 21, 25)
Lights up when the system is turned off.

3
Remote sensor (page 25)

4
USB MEMORY indicator
Lights up when an optional USB device is connected.

5
▲ (open/close) button (page 13)
Press to open or close the disc tray.

6
AUDIO IN jack (page 20)
Connect to an optional audio component.

7
PHONES jack
Connect the headphones.

8
•⇄ (USB) port (page 15, 18, 34)
Connect to an optional USB device.

9
Playback buttons and function buttons

Unit: USB ►|| (play/pause) button (page 18)

Press to select the USB function.
Press to start or pause playback of an optional USB device.

Remote: USB button (page 18)
Press to select the USB function.

Unit: CD ►|| (play/pause) button (page 13)

Press to select the CD function.
Press to start or pause playback of a disc.

Remote: CD button (page 13)
Press to select the CD function.

Remote: ► (play) button,
 ■■ (pause) button
 Press to start or pause playback.

TUNER/BAND button (page 14)
 Press to select the TUNER function.
 Press to select FM or AM reception mode.

Unit: AUDIO IN button (page 20)
 Press to select the AUDIO IN function.

FUNCTION button (page 14, 20)
 Press to select the function.

10
 Unit: CD-USB SYNC/REC1 button
 (page 15, 16)
 Press to record from a disc onto the connected optional USB device.

11
 USB MENU button (page 16, 17)
 Press to erase audio files and folders from the connected optional USB device.
 Press to select which memory to read to if the USB device has more than one memory.

12
 ENTER button (page 12, 15, 16, 17, 22, 23, 24)
 Press to enter the settings.

13
 ◀◀/▶▶ (go back/go forward) button (page 13, 16, 17, 19, 22, 24)
 Press to select a track or file.

Unit: TUNE +/- (tuning) button (page 14)
 Remote: +/- (tuning) button (page 14, 23)
 Press to tune in the desired station.

📁 +/- (select folder) button (page 13, 19, 22)
 Press to select a folder.

◀◀/▶▶ (rewind/fast forward) button (page 13, 19)
 Press to find a point in a track or file.

14
 Unit: VOL +/- button (page 13, 14, 18, 20)
 Remote: VOLUME +/- button (page 13, 14, 18, 20)
 Press to adjust the volume.

15

PLAY MODE/TUNING MODE button (page 13, 14, 15, 19, 22, 23)

Press to select the play mode of a CD, MP3 disc or an optional USB device.
Press to select the tuning mode.

16

Sound buttons (page 21)

Unit: **DSGX** button

Remote: **EQ** button

Press to select the sound effect.

17

Unit: **■/CANCEL** (stop/cancel) button (page 13, 14, 16, 17, 19)

Remote: **■** (stop) button (page 13, 14, 16, 17, 19)

Press to stop playback.

18

CLOCK/TIMER SELECT button (page 24)

CLOCK/TIMER SET button (page 12, 24)

Press to set the clock and the Play Timer.

19

REPEAT/FM MODE button (page 13, 14, 19)

Press to listen to a disc, a single track or file repeatedly.

Press to select the FM reception mode (monaural or stereo).

20

Battery compartment lid (page 11)

21

CLEAR button (page 22)

Press to delete a pre-programmed track or file.

22

TUNER MEMORY button (page 23)

Press to preset the radio station.

23

DISPLAY button (page 21)

Press to change the information on the display.

24

SLEEP button (page 24)

Press to set the Sleep Timer.

Information on the display

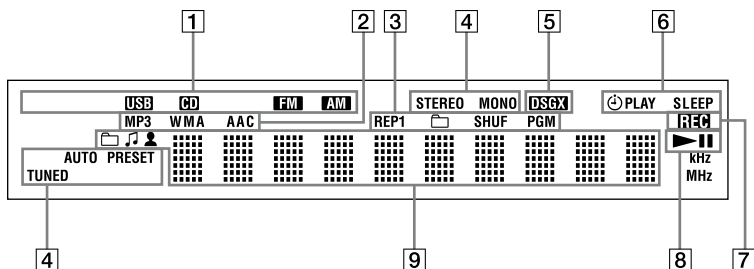

1

Function

5

DSGX (page 21)

2

Audio format

6

Timer (page 24)

3

Play mode (page 13, 19)

7

CD-USB Recording (page 15, 16)

4

Tuner reception mode (page 14)

8

Play/Pause

Tuner reception (page 14)

9

Text information

Getting Started

Hooking up the system securely

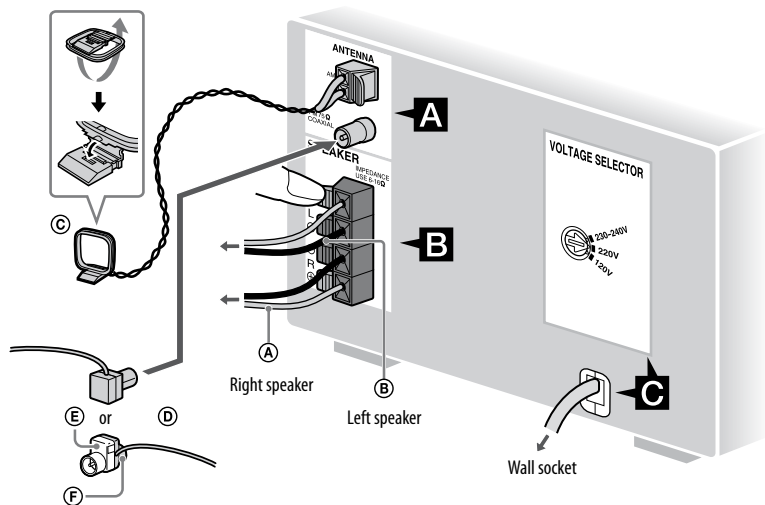

- (A) Speaker cord (Red/⊕)
- (B) Speaker cord (Black/⊖)
- (C) AM loop antenna
- (D) FM lead antenna (Extend it horizontally.)
- (E) White side for North American model
- (F) Brown side for other regions

A Antennas

Find a location and an orientation that provide good reception, and then set up the antenna.

Keep the antennas away from the speaker cords, the power cord and the USB cable to avoid picking up noise.

B Speakers

Insert only the stripped portion of the speaker cords into the SPEAKER jacks.

C Power

For models with a voltage selector, set VOLTAGE SELECTOR to the local power line voltage.

Connect the power cord to a wall socket.

If the plug does not fit the wall socket, detach the supplied plug adaptor (only for models equipped with an adaptor).

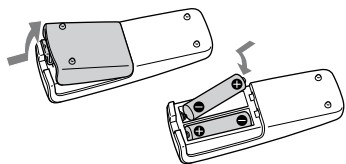

Notes

- With normal use, the batteries should last for about six months.
- Do not mix an old battery with a new one or mix different types of batteries.
- If you do not use the remote for a long period of time, remove the batteries to avoid damage from battery leakage and corrosion.

When carrying this system

- 1 Remove a disc to protect the CD mechanism.
- 2 Press CD **[9]** to select the CD function.
- 3 Hold down VOL + **[14]** and DSGX **[16]** on the unit, and press **▲ [5]** on the unit until "STANDBY" appears.
- 4 After "LOCK" appears, unplug the power cord.

To use the remote

Slide and remove the battery compartment lid **[20]**, and insert the two supplied R6 (size AA) batteries, **+** side first, matching the polarities shown below.

Setting the clock

Use buttons on the remote to set the clock.

- 1** Press I/⏻ **1** to turn on the system.
- 2** Press CLOCK/TIMER SET **18**.
The hour indication flashes in the display.
If “PLAY SET?” flashes in the display, press ◀◀/▶▶ **13** repeatedly to select “CLOCK SET?” and then press ENTER **12**.
- 3** Press ◀◀/▶▶ **13** repeatedly to set the hour, and then press ENTER **12**.
- 4** Use the same procedure to set the minutes.
The clock settings are lost when you disconnect the power cord or if a power failure occurs.

To display the clock when the system is off

Press DISPLAY **23**. The clock is displayed for about 8 seconds.

Basic Operations

Playing a CD/MP3 disc

- 1 Select the CD function.
Press CD [9].
- 2 Place a disc.
Press ▲ [5] on the unit, and place a disc with the label side up on the disc tray.

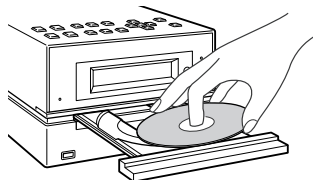

To close the disc tray, press ▲ [5] on the unit again.
Do not force the disc tray closed with your finger, as this may damage the unit.

- 3 Start playback.
Press ► (or CD ►|| on the unit) [9].
- 4 Adjust the volume.
Press VOLUME +/- (or VOL +/- on the unit) [14].

Other operations

To	Press
Pause playback	(or CD ► on the unit) [9]. To resume play, press the button again.
Stop playback	■ [17].
Select a folder on an MP3 disc	Folder +/- [13].
Select a track or file	◀◀/▶▶ [13].
Find a point in a track or file	Hold down ◀◀/▶▶ [13] during playback, and release the button at the desired point.
Select Repeat Play	REPEAT [19] repeatedly until "REP" or "REP1" appears.

To change the play mode

Press PLAY MODE [15] repeatedly while the player is stopped. You can select normal play ("□*"), shuffle play ("SHUF" or "□ SHUF*"), or program play ("PGM").

* When playing a CD-DA disc, □ (SHUF) Play performs the same operation as normal (shuffle) play.

Notes on Repeat Play

- All tracks or files on a disc are played repeatedly up to five times.
- "REP1" indicates that a single track or file is repeated until you stop it.

Notes on playing MP3 discs

- Do not save other types of files or unnecessary folders on a disc that has MP3 files.
- Folders that have no MP3 files are skipped.
- MP3 files are played back in the order that they are recorded onto the disc.
- The system can only play MP3 files that have a file extension of “.MP3”.
- If there are files on the disc that have the “.MP3” file extension, but that are not MP3 files, the unit may produce noise or may malfunction.
- The maximum number of:
 - folders is 255 (including the root folder).
 - MP3 files is 511.
 - MP3 files and folders that can be contained on a single disc is 512.
 - folder levels (the tree structure of files) is 8.
- Compatibility with all MP3 encoding/writing software, recording device, and recording media cannot be guaranteed. Incompatible MP3 discs may produce noise or interrupted audio or may not play at all.

Notes on playing multisession discs

- If the disc begins with a CD-DA (or MP3) session, it is recognized as a CD-DA (or MP3) disc, and other sessions are not played back.
- A disc with a mixed CD format is recognized as a CD-DA (audio) disc.

Listening to the radio

- 1 Select “FM” or “AM.”**
Press FUNCTION (or TUNER/BAND on the unit) [9] repeatedly.
- 2 Select the tuning mode.**
Press TUNING MODE [15] repeatedly until “AUTO” appears.
- 3 Tune in the desired station.**
Press +/- (or TUNE +/- on the unit) [13]. Scanning stops automatically when a station is tuned in, and then “TUNED” and “STEREO” (for stereo programs only) appear.

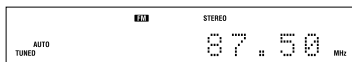

When you tune in a station that provides RDS services, the station name appears on the display (European model only).

- 4 Adjust the volume.**
Press VOLUME +/- (or VOL +/- on the unit) [14].

To stop automatic scanning

Press ■ [17].



To tune in a station with a weak signal

If “TUNED” does not appear and the scanning does not stop, press TUNING MODE [15] repeatedly until “AUTO” and “PRESET” disappear, and then press +/- (or TUNE +/- on the unit) [13] repeatedly to tune in the desired station.

To reduce static noise on a weak FM stereo station

Press FM MODE [19] repeatedly until “MONO” appears to turn off stereo reception.

Recording from a disc onto an USB device

You can connect an optional USB device to the  (USB) port  on the unit and record music from a disc to the USB device.

You can record from a CD-DA disc or MP3 disc only.



The audio format of files recorded by this system is MP3.

The approximate size of the recording is about 1 MB per minute of recording time from a CD. The size may be larger when recording from an MP3 disc.

See “Compatible USB devices with this system” (page 34) for a list of USB devices that can be connected to this system.

Synchro Recording

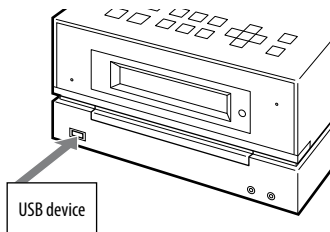

You can easily record an entire disc onto an USB device.

- 1 Connect a recordable USB device to the  (USB) port  as shown below.



When USB cable connection is necessary, connect the USB cable supplied with the USB device to be connected.

See the operation manual supplied with the USB device to be connected for details on the operation method.

- 2 Select the CD function, then load the disc you want to record.
- 3 Press PLAY MODE  repeatedly to select the play mode when the CD player is stopped. The play mode automatically changes to normal play mode, if you start recording in shuffle play mode, repeat play mode or in program play mode (when no tracks or MP3 files are programmed). For details about the play mode, see “To change the play mode” (page 13).
- 4 Press CD-USB SYNC/REC1  on the unit. “REC” flashes, and the display cycles through “CD SYNC,” “xxxMB Free” (remaining space on the USB device) and “Push Enter.” The USB device stands by for recording and the CD player pauses for play.
- 5 Press ENTER . Recording starts. When the recording is completed, the CD player and the USB device stop automatically.







Recording a single track or MP3 file during playback (REC1)

You can easily record the track or MP3 file that is currently being played back onto an USB device.

- 1 Connect a recordable USB device to the  (USB) port **[8]**.
- 2 Select the CD function, then load the disc you want to record.
- 3 Select the track or MP3 file you want to record, then start play.
- 4 Press CD-USB SYNC/REC1 **[10]** on the unit while the selected track or MP3 file is being played back. "REC" flashes, and the display cycles through "REC 1," "xxxMB Free" (remaining space on the USB device) and "Push Enter." The USB device stands by for recording and the CD player pauses for play.
- 5 Press ENTER **[12]**. Recording starts. When the recording is completed, the CD player continues to play.

To select the recording destination on the USB device

If the USB device has more than one memory (for example, internal memory and a memory card), you can select which memory to read to and then start recording.

- 1 Connect the USB device to the  (USB) port **[8]**.
- 2 Select the USB function. Press USB **[9]**.
- 3 Press USB MENU **[11]** on the unit in stop mode. "Select?" appears. If an audio file or a folder is selected, "Erase?" appears instead. Press   **[13]** repeatedly to select "Select?"
- 4 Press ENTER **[12]**. The name of a memory appears. The displayed name varies depending on the specifications of the USB device.
- 5 Press   **[13]** repeatedly to select the memory. Proceed to step 6 if only one memory can be selected. To cancel this operation, press  **[17]**.
- 6 Press ENTER **[12]**.
- 7 Start recording by following steps 2 through 5 of "Synchro Recording" or "Recording a single track or MP3 file during playback (REC1)."

To stop recording





Press  **[17]**.

To remove the USB device

- 1 Select the USB function.
Press USB [9].
- 2 Hold down ■ [17] on the unit in stop mode until "No Device" appears.
- 3 Remove the USB device.

To erase audio files or folders from the USB device

You can erase audio files or folders from the USB device.

- 1 Connect a recordable USB device to the  (USB) port [8].
- 2 Select the USB function.
Press USB [9].
- 3 Press   [13] or  +/- [13] repeatedly to select the audio file or folder you want to erase.
- 4 Press USB MENU [11] on the unit.
"Erase?" appears.
- 5 Press ENTER [12].
"Track Erase?" or "Folder Erase?" appears in the display.
To cancel the erase operation, press ■ [17].
- 6 Press ENTER [12].
The selected audio file or folder is erased.

Folder and file generation rules

When first recording to an USB device, a "MUSIC" folder is created directly below the "ROOT." Folders and files are generated within this "MUSIC" folder as follows according to the recording method.

Synchro Recording¹⁾

Recording source	Folder name	File name
MP3	Same as the recording source ²⁾	
CD-DA	"CDDA001" ³⁾	"TRACK001" ⁴⁾

REC1 recording

Recording source	Folder name	File name
MP3	"REC1" ⁵⁾	Same as the recording source ²⁾
CD-DA		"TRACK001" ⁴⁾

¹⁾ In Program Play mode, the folder name is "PGM_xxx," and the file name depends on the recording source (CD-DA disc or MP3 disc).

²⁾ Up to 32 characters of the name are assigned.

³⁾ Folder numbers are assigned serially thereafter up to the maximum 999 (including the "ROOT" and "MUSIC" folders).

⁴⁾ File numbers are assigned serially thereafter.

⁵⁾ A new file is recorded in the "REC1" folder each time REC1 recording is performed.

Notes

- Do not remove the USB device during recording or erase operations. Doing so may corrupt the data on the USB device or damage the USB device itself.
- Do not connect the system and the USB device through an USB hub.
- When recording from a CD, the tracks are recorded as 128 kbps MP3 files. When recording from an MP3 disc, MP3 files are recorded with the same bit rate as the original MP3 files.
- While recording from an MP3 disc, no sound is output and “High Speed” appears.
- CD text information is not recorded in the created MP3 files.
- If you cancel the recording partway, an MP3 file is created up to the point when the recording was stopped.
- Recording stops automatically if:
 - the USB device runs out of space during recording.
 - the number of audio files on the USB device reaches the limit for the number that the system can recognize.
- The maximum number of audio files and folders that can be contained on a single USB device is 999 (including the “ROOT” and “MUSIC” folders).
The maximum number of audio files and folders may vary depending on the audio file and folder structure.
- You cannot erase audio files and folders in shuffle play mode or program play mode.
- If the folder to be erased contains non-MP3/WMA/AAC format files or sub folders, these are not erased.
- If a folder or file that you are trying to record already exists on the USB device with the same name, a sequential number is added after the name without overwriting the original folder or file.

Listening to music of an USB device

You can listen to music stored in the USB device.

The audio formats that can be played back by this system are as follows:

MP3*/WMA*/AAC*

See “Compatible USB devices with this system” (page 34) for a list of USB devices that can be connected to this system.

* Files with copyright protection (Digital Rights Management) cannot be played by this system.

Files downloaded from an online music store may not be played by this system.

- 1** Select the USB function.
Press USB **[9]**.
- 2** Connect an optional USB device to the  (USB) port **[8]**.



When the USB device is connected, the display changes as follows:

“Reading” → “Storage Drive*”

* When connecting USB storage media, the volume label is displayed next if recorded.

Note

It may take about 10 seconds before “Reading” appears depending on the type of USB device connected.

- 3** Start playback.
Press  (or USB  on the unit) **[9]**.
- 4** Adjust the volume.
Press VOLUME +/- (or VOL +/- on the unit) **[14]**.

Other operations

To	Press
Pause playback	II (or USB ▶II on the unit) [9] . To resume play, press the button again.
Stop playback	■ [17] . To resume play, press ▶ (or USB ▶II on the unit) [9] *. To cancel resume play, press ■ [17] again.
Select a folder	📁 +/- [13] .
Select a file	◀◀/▶▶ [13] .
Find a point in a file	Hold down ◀◀/▶▶ [13] during playback, and release the button at the desired point.
Select Repeat Play	REPEAT [19] repeatedly until “REP” or “REP1” appears.
Remove the USB device	Hold down ■ [17] on the unit until “No Device” appears, then remove the USB device.

* When playing a VBR MP3/WMA file, the system may resume playback from a different point.

To change the play mode

Press **PLAY MODE [15]** repeatedly while the USB device is stopped. You can select normal play (“**📁**” for all files in the folder on the USB device), shuffle play (“**SHUF**” or “**📁 SHUF**”), or program play (“**PGM**”).

Notes on the USB device

- You cannot change the play mode during playback.
- Some time may be needed to start playback when:
 - the folder structure is complex.
 - the memory capacity is excessive.
- When the USB device is inserted, the system reads all the files on the USB device. If there are many folders or files on the USB device, it may take a long time to finish reading the USB device.
- Do not connect the system and the USB device through an USB hub.
- With some connected USB devices, after an operation is performed, there may be a delay before it is performed by this system.
- This system does not necessarily support all the functions provided in a connected USB device.
- The playback order for the system may differ from the playback order of the connected USB device.
- Always hold down **■ [17]** on the unit and make sure that “No Device” appears before removing the USB device. Removing the USB device while “No Device” is not displayed may corrupt the data on it or damage the USB device itself.
- Do not save other types of files or unnecessary folders on an USB device that has audio files.
- Folders that have no audio files are skipped.
- The maximum number of audio files and folders that can be contained on a single USB device is 999 (including the “ROOT” and “MUSIC” folders).
The maximum number of audio files and folders may vary depending on the file and folder structure.

- The audio formats that you can listen to with this system are as follows:
 - MP3: file extension “.mp3”
 - Windows Media Audio file: file extension “.wma”
 - AAC: file extension “.m4a”

Note that even when file names have the above file extensions, if the actual file differs, the system may produce noise or may malfunction.

- Compatibility with all encoding/writing softwares, recording devices, and recording media cannot be guaranteed. Incompatible USB device may produce noise or interrupted audio or may not play at all.

Using optional audio components

- 1** Connect additional audio component to the AUDIO IN jack [6] on the unit using an audio analog cord (not supplied).
- 2** Turn down the volume.
Press VOLUME – (or VOL – on the unit) [14].
- 3** Select the AUDIO IN function.
Press FUNCTION (or AUDIO IN on the unit) [9] repeatedly.
- 4** Start playing the connected component.
- 5** Adjust the volume.
Press VOLUME +/- (or VOL +/- on the unit) [14].

Adjusting the sound

To add a sound effect

To	Press
Generate a more dynamic sound (Dynamic Sound Generator X-tra)	DSGX [16] on the unit.
Set the sound effect	EQ [16] repeatedly to select "BASS" or "TREBLE," and then press +/- [13] repeatedly to adjust the level.

Changing the display

To	Press
Change information on the display ¹⁾	DISPLAY [23] repeatedly when the system is on.
Check the clock when the system is off	DISPLAY [23] when the system is off ²⁾ . The clock is displayed for 8 seconds.

- ¹⁾ For example, you can view CD/MP3 disc information, such as;
- track or file number during normal play.
 - track or file name ("🎵") during normal play.
 - artist name ("👤") during normal play.
 - album or folder name ("📁") during normal play.
 - total playing time while the player is stopped.
- ²⁾ The STANDBY indicator **[2]** on the unit lights up when the system is off.

Notes on the display information

- Characters that cannot be displayed appear as "_".
- The following are not displayed:
 - total playing time for a CD-DA disc depending on the play mode.
 - total playing time and remaining playing time for an MP3 disc and USB device.
- The following is not displayed correctly:
 - folder and file names that do not follow either the ISO9660 Level 1, Level 2 or Joliet in the expansion format.
- The following are displayed:
 - ID3 tag information for MP3 files when ID3 version 1 and version 2 tags are used (up to 62 characters for an MP3 disc).
 - The Russian model can display information in Russian characters, but the characters may not be displayed correctly for discs created with some encoding/writing software and some recording device.

Other Operations

Creating your own program

(Program Play)

- 1 Select the desired function.

CD

Press CD [9] to select the CD function.

USB

Press USB [9] to select the USB function.

- 2 Press PLAY MODE [15] repeatedly until "PGM" appears while the system is stopped.

- 3 Press [Left Arrow]/[Right Arrow] [13] repeatedly until the desired track or file number appears.

When programming files, press [Folder Icon] +/- [13] repeatedly to select the desired folder, and then select the desired file.

Example: When programming tracks on a CD

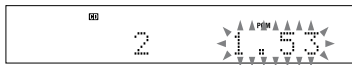

Selected track or file number

Total playing time of program (including selected track or file)

- 4 Press ENTER [12] to add the track or file to the program.

CD

"- - -" appears when the total program time exceeds 100 minutes for a CD, or when you select a CD track whose number is 21 or over, or when you select an MP3 file.

USB

The total program time cannot be displayed, so "- - -" appears.

- 5 Repeat steps 3 through 4 to program additional tracks or files, up to a total of 25 tracks or files.

- 6 To play your program of tracks or files, press [Play] [9].

The program remains available until you open the disc tray or remove the USB device. To play the same program again, press [Play] [9].

To cancel Program Play

Press PLAY MODE [15] repeatedly until "PGM" disappears while the system is stopped.

To delete the last track or file of the program

Press CLEAR [21] while the system is stopped.

Presetting radio stations

You can preset your favorite radio stations and tune them in instantly by selecting the corresponding preset number.

Use buttons on the remote to preset stations.

- 1 Tune in the desired station (see “Listening to the radio” (page 14)).
- 2 Press TUNER MEMORY **[22]**.



- 3 Press +/- **[13]** repeatedly to select your desired preset number.
If another station is already assigned to the selected preset number, the station is replaced by the new stations.
- 4 Press ENTER **[12]**.
- 5 Repeat steps 1 through 4 to store other stations.
You can preset up to 20 FM and 10 AM stations.
The preset stations are retained for about half a day even if you disconnect the power cord or if a power failure occurs.

- 6 To call up a preset radio station, press TUNING MODE **[15]** repeatedly until “PRESET” appears, and then press +/- **[13]** repeatedly to select the desired preset number.

Using the Timers

The system offers two timer functions. If you use the Play Timer with the Sleep Timer, the Sleep Timer has priority.

Sleep Timer:

You can fall asleep to music. This function works even if the clock is not set.

Press SLEEP [24] repeatedly.

If you select "AUTO," the system automatically turns off after the current disc or USB device stops or in 100 minutes.

Play Timer:

You can wake up to CD, tuner or optional USB device at a preset time.

Use buttons on the remote to control the Play Timer. Make sure you have set the clock.

- 1 Prepare the sound source.
Prepare the sound source, and then press VOLUME +/- [14] to adjust the volume.
To start from a specific track or file, create your own program (page 22).
- 2 Press CLOCK/TIMER SET [18].
- 3 Press I◀◀/▶▶I [13] repeatedly to select "PLAY SET?," and then press ENTER [12].
"ON TIME" appears, and the hour indication flashes.
- 4 Set the time to start playing.
Press I◀◀/▶▶I [13] repeatedly to set the hour, and then press ENTER [12].
The minute indication flashes. Use the procedure above to set the minutes.

- 5 Use the same procedure as in step 4 to set the time to stop playing.

- 6 Select the sound source.

Press I◀◀/▶▶I [13] repeatedly until the desired sound source appears, and then press ENTER [12]. The display shows the timer settings.

- 7 Press I/⏻ [1] to turn off the system.

The system turns on 15 seconds before the preset time. If the system is on at the preset time, the Play Timer will not play.

To activate or check the timer again

Press CLOCK/TIMER SELECT [18], press I◀◀/▶▶I [13] repeatedly until "PLAY SEL?" appears, and then press ENTER [12].

To cancel the timer

Repeat the same procedure as above until "TIMER OFF?" appears, and then press ENTER [12].

To change the setting

Start over from step 1.

Tip

The Play Timer setting remains as long as the setting is not canceled manually.

Troubleshooting

- 1 Make sure the power cord and speaker cords are correctly and firmly connected.
- 2 Find your problem in the checklist below, and take the indicated corrective action.
If the issue persists, contact your nearest Sony dealer.

If the STANDBY indicator flashes

Immediately unplug the power cord, and check the following items.

- If your system has a voltage selector, is the voltage selector set to the correct voltage?
- Are you using only the supplied speakers?
- Is anything blocking the ventilation holes on the top or back of the system?

After the STANDBY indicator **2** stops flashing, reconnect the power cord, and turn on the system. If the issue persists, contact your nearest Sony dealer.

General

Sound comes from one channel, or the left and right volumes are unbalanced.

- Place the speakers as symmetrically as possible.
- Connect only the supplied speakers.

Severe hum or noise.

- Move the system away from sources of noise.
- Connect the system to a different wall socket.
- Install a noise filter (available separately) to the power cord.

The remote does not function.

- Remove any obstacles between the remote and the remote sensor **3** on the unit, and position the unit away from fluorescent lights.
- Point the remote at the system's sensor.
- Move the remote closer to the system.

The STANDBY indicator **2** remains lit after unplugging the power cord.

- The STANDBY indicator **2** may not turn off immediately after unplugging the power cord. This is not a malfunction. The indicator will turn off after about 40 seconds.

CD/MP3 player

The sound skips, or the disc will not play.

- Wipe the disc clean, and replace it.
- Move the system to a location away from vibration (for example, on top of a stable stand).
- Move the speakers away from the system, or place them on separate stands. At high volume, speaker vibration may cause the sound to skip.

Play does not start from the first track.

- Press PLAY MODE **[15]** repeatedly until both “PGM” and “SHUF” disappear to return to normal play.

Starting playback takes more time than usual.

- The following discs take a longer time to start playback.
 - a disc recorded with a complicated tree structure.
 - a disc recorded in multisession mode.
 - a disc that has not been finalized (a disc to which data can be added).
 - a disc that has many folders.

USB device

You cannot start recording to an USB device.

- The following problems may have occurred.
 - The USB device is full.
 - The number of files and folders on the USB device has reached the upper limit.
 - The USB device is write-protected.

Recording is stopped before it is finished.

- You are using an unsupported USB device. See “Compatible USB devices with this system” (page 34) for the supported device types.
- The USB device is not formatted correctly. Refer to the USB device operation manual for how to format.

- Turn off the system and remove the USB device. If the USB device has a power switch, turn the USB device off and then on again after removing it from the system. Then perform recording again.
- If the recording and erase operations are repeated multiple times, the file structure within the USB device becomes fragmented. Refer to the USB device operation manual for how to deal with this problem. If the problem persists, contact your nearest Sony dealer.

Recording to an USB device results in an error.

- You are using an unsupported USB device. See “Compatible USB devices with this system” (page 34) for the supported device types.
- Turn off the system and remove the USB device. If the USB device has a power switch, turn the USB device off and then on again after removing it from the system. Then perform recording again.
- The USB device was disconnected or the power was turned off during recording. Delete the partially-recorded file, and record again. If this does not fix the problem, the USB device may be broken. Refer to the USB device operation manual for how to deal with this problem. If the problem persists, contact your nearest Sony dealer.





Files or folders on the USB device cannot be erased.

- Check if the USB device is write-protected.
- The USB device was disconnected or the power was turned off during the erase operation. Delete the partially-erased file. If this does not fix the problem, the USB device may be broken. Refer to the USB device operation manual for how to deal with this problem. If the problem persists, contact your nearest Sony dealer.

Are you using a supported USB device?

- If you connect an unsupported USB device, the following problems may occur. See “Compatible USB devices with this system” (page 34) for the supported device types.
 - The USB device is not recognized.
 - File or folder names are not displayed on this system.
 - Playback is not possible.
 - The sound skips.
 - There is noise.
 - A distorted sound is output.
 - Recording stops before it is finished.

“Over Current” appears.

- A problem has been detected with the level of electrical current from the  (USB) port . Turn off the system and remove the USB device from the  (USB) port . Make sure there is no problem with the USB device. If this display pattern persists, contact your nearest Sony dealer.

There is no sound.

- The USB device is not connected correctly. Turn off the system, then reconnect the USB device and check if the USB MEMORY indicator  lights up.

There is noise, skipping, or distorted sound.

- Turn off the system, then reconnect the USB device.
- The music data itself contains noise, or the sound is distorted. Noise may have entered during the recording process. Delete the file, and try recording again.

The USB device cannot be connected into the (USB) port .

- The USB device is being connected backwards. Connect the USB device in the correct orientation.

“Reading” is displayed for an extended time, or it takes a long time before playback starts.

- The reading process can take a long time in the following cases.
 - There are many folders or files on the USB device.
 - The file structure is extremely complex.
 - The memory capacity is excessive.
 - The internal memory is fragmented.
 Thus, we recommend following these guidelines.
 - Total folders on USB device: 100 or less
 - Total files per folder: 100 or less

Erroneous display

- Send the music data to the USB device again, as the data stored in the USB device may have been corrupted.
- The character codes that can be displayed by this system are numbers and alphabet only. Other characters are not displayed correctly.

The USB device is not recognized.

- Turn off the system and reconnect the USB device, then turn on the system.
- Connect the supported USB device (page 34).
- The USB device does not work properly. Refer to the USB device operation manual for how to deal with this problem. If the problem persists, contact your nearest Sony dealer.

Play does not start.

- Turn off the system and reconnect the USB device, then turn on the system.
- Connect the supported USB device (page 34).
- Press **▶** (or USB **▶||** on the unit) **[9]** to start play.

Play does not start from the first track.

- Set the play mode to Normal Play mode.

Files cannot be played back.

- The audio file does not have the extension “.mp3”, “.wma”, “.m4a”.
- The data is not stored in MP3/WMA/AAC format.
- USB storage media formatted with file systems other than FAT16 or FAT32 are unsupported.*
- If you use partitioned USB storage media, only files on the first partition can be played.
- Playback is possible up to 8 levels.
- The number of folders has exceeded 999.
- The number of files has exceeded 999.
- Files that are encrypted or protected by passwords, etc. cannot be played back.

* This system supports FAT16 and FAT32, but some USB storage media may not support all of these FAT. For details, see the operation manual of each USB storage media or contact the manufacturer.

Tuner

Severe hum or noise, or stations cannot be received. ("TUNED" or "STEREO" flashes on the display.)

- Connect the antenna properly.
- Find a location and an orientation that provide good reception, and then set up the antenna again.
- Keep the antennas away from the speaker cords, the power cord and the USB cable to avoid picking up noise.
- Connect a commercially available external antenna.
- Consult your nearest Sony dealer if the supplied AM antenna has come off the plastic stand.
- Turn off nearby electrical equipment.

To change the AM tuning interval

The AM tuning interval is factory-preset to 9 kHz (or 10 kHz, for some areas; this function is not available on the European and Russian models).

Use buttons on the unit to change the AM tuning interval.

- 1 Tune in any AM station, and then turn off the system.
- 2 While holding down ENTER **[12]**, press I/⏻ **[1]**.
All the AM preset stations are erased. To reset the interval to the factory preset, repeat the procedure.

To improve tuner reception

Turn off CD player power by using the CD power management function. By default, CD power is turned on.

- 1 Press CD **[9]** to select the CD function, and then turn off the system.
- 2 After "STANDBY" stops flashing, press I/⏻ **[1]** on the unit while holding down ■ **[17]** on the unit. "CD POWER OFF" appears. With CD player power turned off, disc access time is increased. To turn on CD player power, repeat the procedure until "CD POWER ON" appears.

To reset the system to factory settings

If the system still does not operate properly, reset the system to factory settings.

Use buttons on the unit to reset the system to its factory default settings.

- 1 Disconnect and reconnect the power cord, and then turn on the system.
- 2 Press ■ **[17]**, VOL + **[14]** and I/⏻ **[1]** at the same time.
All user-configured settings, such as preset radio stations, timer, and the clock, are deleted.

Messages

CD/MP3 player, Tuner

CD Over: You have reached the end of the disc while pressing ►► [13] during playback or pause.

Complete! The preset operation ended normally.

LOCKED: The disc tray does not open. Contact your nearest Sony dealer.

No Disc: There is no disc in the system, or you have loaded a disc that cannot be played.

No Step: All of the programmed tracks or files have been erased.

Push SELECT!: You tried to set the clock or timer during timer operation.

Push STOP!: You pressed PLAY MODE [15] during playback.

Reading: The system is reading information of the disc. Some buttons are not available.

SET CLOCK!: You tried to select the timer when the clock is not set.

SET TIMER!: You tried to select the timer when the Play Timer is not set.

Step Full!: You tried to program more than 26 tracks or files (steps).

TIME NG!: The Play Timer start and end times are set to the same time.

USB device

Complete! The audio file or folder on the USB device has been erased.

Device Full!: The USB device is full.

Erase Error!: Erase of audio files or folders on the USB device failed.

Error: The USB device could not be recognized or an unknown device is connected (page 28).

Fatal Error!: The USB device has been disconnected while recording to or erasing audio files or folders on the USB device.

FLDR Full: The number of folders on the USB device has reached the maximum.

No Device: No USB device is connected or the connected USB device has been stopped.

No Step: All of the programmed tracks or files have been erased.

No Track: No playable file is loaded in the system.

Not in Use: You have made an invalid operation.

Not Supported: An unsupported USB device is connected.

Please Wait: The system is readying for usage of an USB device.

Protected!: You tried to record or erase a write-protected USB device.

Reading: The system is recognizing the USB device.

REC Error!: Recording did not start, stopped partway, or otherwise could not be performed (page 26).

Removed: The USB device has been removed.

Step Full!: You tried to program more than 26 tracks or files (steps).

Storage Drive: An USB device is connected.

Track Full: The number of files on the USB device has reached the maximum.

Precautions

Discs that this system CAN play

- Audio CD
- CD-R/CD-RW (audio data/MP3 files)

Discs that this system CANNOT play

- CD-ROM
- CD-R/CD-RW other than those recorded in music CD format or MP3 format conforming to ISO9660 Level 1/Level 2, Joliet or multisession
- CD-R/CD-RW recorded in multisession that have not ended by "closing the session"
- CD-R/CD-RW of poor recording quality, CD-R/CD-RW that have scratches or are dirty, or CD-R/CD-RW recorded with an incompatible recording device
- CD-R/CD-RW which is finalized incorrectly
- Discs containing files other than MPEG 1 Audio Layer-3 (MP3) files
- Discs of non-standard shape (for example, heart, square, star)
- Discs that have adhesive tape, paper, or sticker attached to them
- Rental or used discs with attached seals where the glue extends beyond the seal
- Discs that have labels printed using ink that feels tacky when touched

Notes on discs

- Before playing, wipe the disc with a cleaning cloth from the center out to the edge.
- Do not clean discs with solvents, such as benzine thinner, or commercially available cleaners or anti-static spray intended for vinyl LPs.
- Do not expose discs to direct sunlight or heat sources such as hot air ducts, nor leave it in a car parked in direct sunlight.

On safety

- Completely disconnect the power cord (mains lead) from the wall socket (mains) if it is not going to be used for an extended period of time. When unplugging the unit, always grip the plug. Never pull the cord itself.
- Should any solid object or liquid get into the system, unplug the system, and have it checked by qualified personnel before operating it again.
- The AC power cord can be changed only by a qualified service facility.

On placement

- Do not place the system in an inclined position or in locations that are extremely hot, cold, dusty, dirty, or humid or lacking adequate ventilation, or subject to vibration, direct sunlight or a bright light.
- Be careful when placing the unit or speakers on surfaces that have been specially treated (for example, with wax, oil, polish) as staining or discoloration of the surface may result.

- If the system is brought directly from a cold to a warm location or is placed in a very damp room, moisture may condense on the lens inside the CD player, and cause the system to malfunction. In this situation, remove the disc, and leave the system turned on for about an hour until the moisture evaporates.

On heat buildup

- Heat buildup on the unit during operation is normal and is not cause for alarm.
- Do not touch the cabinet if it has been used continuously at a high volume because the cabinet may have become hot.
- Do not obstruct the ventilation holes.

On the speaker system

This speaker system is not magnetically shielded, and the picture on nearby TV sets may become magnetically distorted. In this situation, turn off the TV, wait 15 to 30 minutes, and turn it back on. If there is no improvement, move the speakers far away from the TV.

Cleaning the cabinet

Clean this system with a soft cloth slightly moistened with a mild detergent solution. Do not use any type of abrasive pad, scouring powder, or solvent, such as thinner, benzine, or alcohol.

Specifications

Main unit

Amplifier section

European and Russian models:

DIN power output (rated):
18 + 18 watts (6 ohms at 1 kHz, DIN)
Continuous RMS power output
(reference): 25 + 25 watts (6 ohms at
1 kHz, 10% THD)
Music power output (reference):
38 + 38 watts (6 ohms at 1 kHz, 10%
THD)

Other models:

DIN power output (rated):
18 + 18 watts (6 ohms at 1 kHz, DIN)
Continuous RMS power output
(reference): 25 + 25 watts (6 ohms at
1 kHz, 10% THD)

Inputs:

AUDIO IN (stereo mini jack):
voltage 250 mV, impedance
47 kilohms
• (USB) port: Type A, maximum
current 500 mA

Outputs:

PHONES (stereo mini jack): accepts
headphones of 8 ohms or more
SPEAKER: accepts impedance of
6 ohms

USB section

Supported bit rate

MP3 (MPEG 1 Audio Layer-3):
32 – 320 kbps, VBR
WMA: 32 – 192 kbps, VBR
AAC: 48 – 320 kbps

Sampling frequencies

MP3 (MPEG 1 Audio Layer-3):
32/44.1/48 kHz
WMA: 44.1 kHz
AAC: 44.1 kHz

CD player section

System: Compact disc and digital audio system

Laser Diode Properties

Emission Duration: Continuous

Laser Output*: Less than 44.6 μ W

* This output is the value measurement at a distance of 200mm from the objective lens surface on the Optical Pick-up Block with 7mm aperture.

Frequency response: 20 Hz — 20 kHz

Signal-to-noise ratio: More than 90 dB

Dynamic range: More than 90 dB

Tuner section

FM stereo, FM/AM superheterodyne tuner

FM tuner section:

Tuning range:

87.5 — 108.0 MHz (50 kHz step)

Antenna: FM lead antenna

Antenna terminals: 75 ohms unbalanced

Intermediate frequency: 10.7 MHz

AM tuner section:

Tuning range

European and Russian models:

531 — 1,602 kHz (with 9 kHz tuning interval)

Other models:

530 — 1,710 kHz (with 10 kHz tuning interval)

531 — 1,710 kHz (with 9 kHz tuning interval)

Antenna: AM loop antenna, external antenna terminal

Intermediate frequency: 450 kHz

Speaker

Speaker system: 2-way, 2-unit, bass-reflex type

Speaker units: Woofer 10 cm, cone type,

Tweeter 4 cm, cone type

Rated impedance: 6 ohms

Dimensions (w/h/d): Approx. 140 × 245 × 215 mm (with speaker grill)

Mass: Approx. 1.9 kg

General

Power requirements

European and Russian models: 230 V AC, 50/60 Hz

Mexican model: 120 V AC, 60 Hz

Argentine model: 220 V AC, 50/60 Hz

Other models: 120 V, 220 V, 230 — 240 V AC, 50/60 Hz, adjustable with voltage selector

Power consumption

European model: 60 watts

Other models: 63 watts

Dimensions (w/h/d) (excl. speakers):

Approx. 215 × 140 × 298 mm

Mass (excl. speakers): Approx. 3.9 kg

Supplied accessories: Remote Commander (1), R6 (Size AA) batteries (2), AM loop antenna (1), FM lead antenna (1)

Design and specifications are subject to change without notice.



- Standby power consumption: 0.5 W
- Halogenated flame retardants are not used in the certain printed wiring boards.
- Halogenated flame retardants are not used in cabinets.

Compatible USB devices with this system

You can use the following Sony USB devices on this system. Other USB devices are not playable/recordable on this system.

Verified Sony digital music player (as of March 2008)

Product name	Model name
Walkman®	NWD-B103 / B103F / B105 / B105F
	NWZ-A815 / A816 / A818 / B103F / B105F
	NWZ-S515 / S516 / S615F / S616F / S618F

Check the websites below for the latest information about compatible devices.

For customers in the U.S.A.:

<<http://www.sony.com/shelfsupport>>

For customers in Canada:

English <<http://www.sony.ca/ElectronicsSupport/>>

French <<http://fr.sony.ca/ElectronicsSupport/>>

For customers in Europe:

<<http://support.sony-europe.com/>>

For customers in Latin America:

<<http://www.sony-latin.com/index.crp>>

For customers in Asia and Oceania:

<<http://www.sony-asia.com/support>>

Notes

- When formatting the digital music player or USB device, be sure to format using the device itself or the dedicated formatting software for that device. Otherwise, you may be unable to record the USB device properly on this system.
- Do not use USB devices other than these USB devices. Operation of models not listed here is not guaranteed.
- Operation may not always be ensured even when using these USB devices.
- Some of these USB devices may not be available for purchase in certain areas.

Notes on Walkman®

- When transferring music to a Walkman® using “Media Manager for WALKMAN,” be sure to transfer in MP3 format. Files in MP4 format (AAC or VIDEO) are not displayed by this system.
- When connecting a Walkman® to the system, be sure to connect after the display “Creating Library” or “Creating Database” on the Walkman® has disappeared.

