

SONY

3-700-813-12(1)

CD Radio Cassette-Corder

Operating Instructions

US

CFD-S03CP

©2008 Sony Corporation Printed in China
http://www.sony.net/

WARNING

To reduce the risk of fire or electric shock, do not expose this apparatus to rain or moisture.

To reduce the risk of fire, do not cover the ventilation of the apparatus with newspapers, tablecloths, curtains, etc. And do not place lighted candles on the apparatus.

To reduce the risk of fire or electric shock, do not expose this apparatus to dripping or splashing, and do not place objects filled with liquids, such as vases, on the apparatus.

As the main plug is used to disconnect the unit from the mains, connect the unit to an easily accessible AC outlet. Should you notice an abnormality in the unit, disconnect the main plug from the AC outlet immediately.

The unit is not disconnected from the AC power source (mains) as long as it is connected to the wall outlet, even if the player itself has been turned off.

Do not install the appliance in a confined space, such as a bookcase or built-in cabinet.

Do not expose the batteries (battery pack or batteries installed) to excessive heat such as sunshine, fire or the like for a long time.

The nameplate and important information concerning safety are located on the bottom exterior.

Power sources

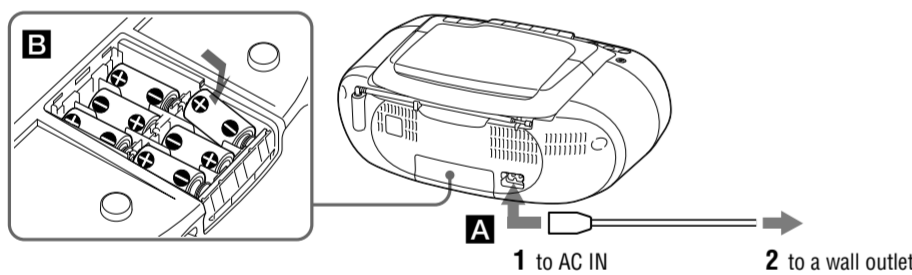

Connect the AC power cord **A** or insert six R14 (size C) batteries (not supplied) into the battery compartment **B**.

Notes

- Replace the batteries when the OPR/BATT indicator [1] dims or when the player stops operating. Replace all the batteries with new ones. Before you replace the batteries, be sure to take out the CD from the player.
- To use the player on batteries, disconnect the AC power cord from the player.
- When you operate the player on batteries, you cannot turn on the player using the remote.

Preparing the remote

Insert two R03 (size AAA) batteries (not supplied).

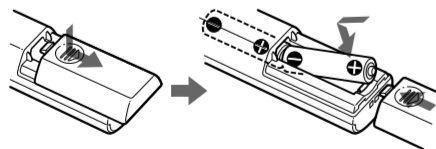

Replacing batteries

With normal use, the batteries should last for about six months. When the remote no longer operates the player, replace all the batteries with new ones.

Notes on DualDiscs

A DualDisc is a two sided disc product which mates DVD recorded material on one side with digital audio material on the other side. However, since the audio material side does not conform to the Compact Disc (CD) standard, playback on this product is not guaranteed.

Music discs encoded with copyright protection technologies

This product is designed to playback discs that conform to the Compact Disc (CD) standard. Recently, various music discs encoded with copyright protection technologies are marketed by some record companies. Please be aware that among those discs, there are some that do not conform to the CD standard and may not be playable by this product.

MPEG Layer-3 audio coding technology and patents licensed from Fraunhofer IIS and Thomson.

Basic Operations

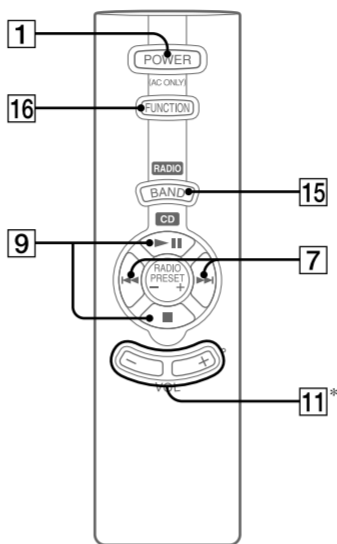
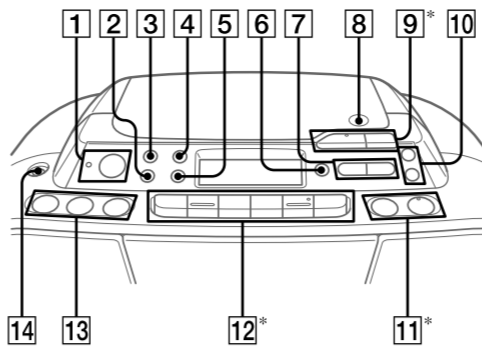

*VOLUME + (VOL + on the remote) [11], [9] and [12] on the unit have a tactile dot.

To	Press
Pause playback	[9]. To resume play, press it again.
Stop playback	[9].
Go to the next track/MP3 file	[7].
Go back to the previous track/MP3 file	[7].
Select a folder on an MP3 disc	[10] on the unit to go forward and [10] to go backward.
Play the selected folder only (MP3 disc only)	MODE [4] on the unit until "FLDR" appears, [9] + or [10] on the unit to select a folder and then [9] to start playing.
Locate a point while listening to the sound	[7] (forward) or [7] (backward) while playing and hold it until you find the point.
Locate a point while observing the display	[7] (forward) or [7] (backward) in pause and hold it until you find the point.
Remove the CD	[8] PUSH OPEN/CLOSE [8] on the unit.

Tips

- Playback starts from the track/MP3 file you last stopped playing (Resume play). During stop, the track/MP3 file number to be played is displayed.
- To cancel the resume play (to start play from the beginning of the first track/MP3 file), press [9] in stop mode. When you open the CD compartment or turn off the unit, the resume play is also canceled.

Example of folder structure and playing order

The playing order of the folders and files is as follows:

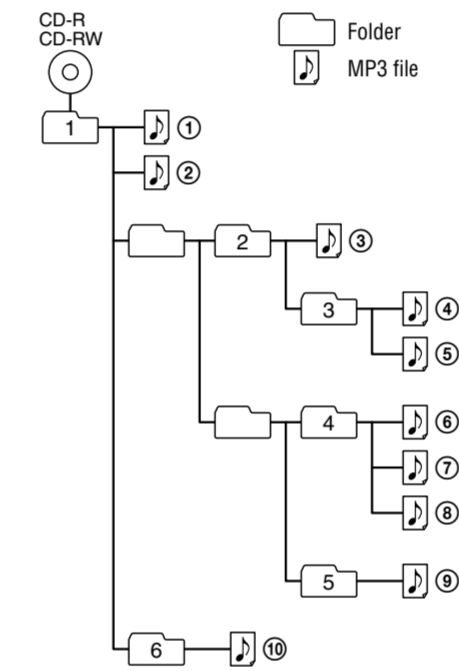

Notes on MP3 discs

- When the disc is inserted, the player reads all the files on that disc. During this time, "READING" is displayed. If there are many folders or non-MP3 files on the disc, it may take a long time for play to begin or for the next MP3 file to start play.
- We recommend that you do not save unnecessary folders or files other than MP3 ones in the disc to be used for MP3 listening.
- A folder that does not include an MP3 file is skipped.
- Maximum number of files: 255
- Maximum number of folders: 150 (including the root folder)
- Maximum number of folders and files in total: 300
- Maximum directory levels: 8
- Folder names and file names can be displayed with up to 16 characters including quotation marks.
- The characters A - Z, 0 - 9, and _ can be displayed on this player. Other characters are displayed as " _ ".
- This player conforms to Version 1.0, 1.1, 2.2, 2.3 and 2.4 of the ID3 tag format. When the file has the ID3 tag information, "song title", "artist name" and "album name" can be displayed and "ID3" appears in the display. If the file does not have the ID3 tag information, "No title" appears instead of song title, "No album" appears instead of album name and "No artist" appears instead of artist name. The ID3 tag information can be displayed with up to 15 characters.
- When naming, be sure to add the file extension "mp3" to the file name.
- If you put the extension "mp3" to a file other than an MP3 file, the player cannot recognize the file properly and will generate random noise that could damage your speakers.
- The file name does not correspond to the ID3 tag.

Listening to the radio

1 Press RADIO+BAND+AUTO PRESET [13] on the unit (BAND [15] on the remote) repeatedly (direct power-on).

Each time you press the button, the indication changes as follows:
"FM" → "AM"

2 Hold down TUNE + or [10] until the frequency digits begin to change in the display.

The player automatically scans the radio frequencies and stops when it finds a clear station.

If you can not tune in a station, press TUNE + or [10] repeatedly to change the frequency step by step. When an FM stereo broadcast is received, "ST" appears.

Tip

If the FM broadcast is noisy, press MODE [4] until "MONO" appears in the display and the radio will play in monaural.

Before using the unit

To turn on/off the power
Press POWER [1].

To adjust the volume
Press VOLUME +, - (VOL +, - on the remote) [11].

To listen through headphones
Connect the headphones to the (headphones) jack [14].

To reinforce the bass sound
Press MEGA BASS [2].
"MEGA BASS" appears in the display.
To return to normal sound, press the button again.

Playing a CD/MP3 disc

1 Press CD [13] on the unit (direct power-on).
(On the remote, press POWER [1] and then press FUNCTION [16] repeatedly until "CD" appears in the display.)

2 Press [8] PUSH OPEN/CLOSE [8] on the unit, and place a disc with the label side up on the CD compartment.

To close the CD compartment, press [8] PUSH OPEN/CLOSE [8] on the unit.

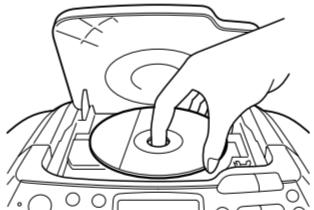

3 Press [9].

The player plays all the tracks/MP3 files once. When you play a MP3 disc, MP3 indicator lights up after the player reads the file information.

Audio CD

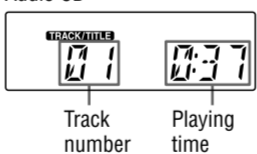

MP3 disc

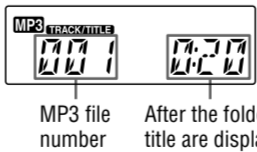

- If there is no folder, "ROOT" appears in the display.
- If there is no song title in ID3 tag information "No Title" will be displayed.
- ** If the playing time is more than 100 minutes, it appears "----" in the display.

Specifications

CD player section

System
Compact disc digital audio system
Laser diode properties
Emission duration: Continuous
Laser output: Less than 44.6 μW
(This output is the value measured at a distance of 200 mm from the objective lens surface on the optical pick-up block with 7 mm aperture.)
Number of channels
2
Frequency response
20 - 20,000 Hz ±1 dB
Wow and flutter
Below measurable limit

Radio section

Frequency range
FM: 87.5 - 108 MHz
AM: Taiwanese model: 531 - 1 611 kHz
Other models: 530 - 1 710 kHz

Antenna

FM: Telescopic antenna
AM: Built-in ferrite bar antenna

Cassette-corder section

Recording system
4-track 2 channel stereo
Fast winding time
Approx. 150 s (sec.) with Sony cassette C-60
Frequency response
TYPE I (normal): 80 - 10 000 Hz

General

Speaker
Full range: 8 cm (3 1/8 inches) dia., 4 Ω, cone type (2)
Outputs
Headphones jack (stereo minijack):
For 16 - 32 Ω impedance headphones
Power output
1.7 W + 1.7 W (at 4 Ω, 10% harmonic distortion)
Power requirements
For CD radio cassette-corder:
120 V AC, 60 Hz
9 V DC, 6 R14 (size C) batteries
For remote control:
3 V DC, 2 R03 (size AAA) batteries

Power consumption

AC 13 W
Battery life
For CD radio cassette-corder:

FM recording

Sony R14P: approx. 6 h
Sony alkaline LR14: approx. 20 h

Tape playback

Sony R14P: approx. 3 h
Sony alkaline LR14: approx. 12 h

CD play back

Sony R14P: approx. 1 h
Sony alkaline LR14: approx. 4.5 h

Dimensions
Approx. 360 × 141 × 235 mm (w/h/d)
(14 1/8 × 5 5/8 × 9 3/8 inches) (incl. projecting parts)

Mass
Approx. 2.6 kg (5 lb. 11 oz) (incl. batteries)

Supplied accessories
AC power cord (1)
Remote control (1)

Design and specifications are subject to change without notice.

Optional accessories

Sony MDR headphones series

Other Operations

Using the display

You can check information about the CD using the display.

Checking the information of an audio CD

To check the total track number and playing time of the CD

Press **■** [**9**] twice, and you can check them in the display.

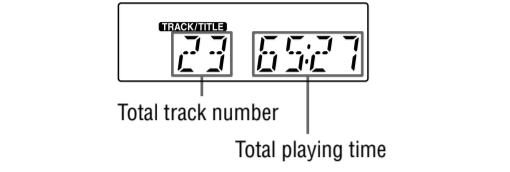

Checking the information of an MP3 disc

To check the total folder number and total file number on the CD

Press **■** [**9**] twice, and you can check them in the display.

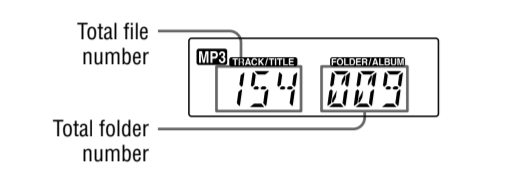

To check file information

Press DISPLAY•ENTER [**5**] on the unit while playing an MP3 disc. The display changes as follows:

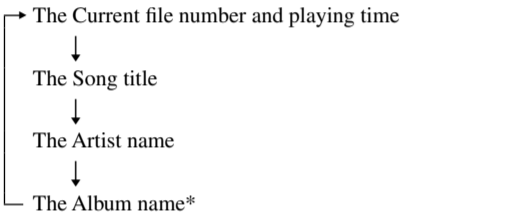

If the file does not have ID3 tag information, "No title", "No artist", "No album", appears in the display.

* If there is no folder, "ROOT" appears.

Playing tracks/MP3 files repeatedly (Repeat Play)

You can play tracks/MP3 files repeatedly in normal, shuffle or program play modes.

- Press CD [**13**] on the unit.

"CD" appears in the display.

2 Proceed as follows.

To repeat	Do this
A single track/MP3 file	<ol style="list-style-type: none">Press REPEAT [6] on the unit until ⏮ "1" appears. Press ◀ or ▶ [7] to select the track/MP3 file that you want to repeat. Press ▶ II [9].
All tracks/MP3 files on the CD	<ol style="list-style-type: none">Press REPEAT [6] on the unit until ⏮ appears. Press ▶ II [9].
A selected folder (MP3 disc only)	<ol style="list-style-type: none">Press MODE [4] on the unit to display "FLDR" and then press REPEAT [6] on the unit until ⏮ appears. Select the folder by pressing □ + or − [10] on the unit. Press ▶ II [9].
Tracks/MP3 files in random order	<ol style="list-style-type: none">Start Shuffle Play (see "Playing tracks/MP3 files in random order"). Press REPEAT [6] on the unit until "SHUF" and ⏮ appear. Press ▶ II [9].
Files in a selected folder in random order (MP3 disc only)	<ol style="list-style-type: none">Start Folder Shuffle Play (see "Playing tracks/MP3 files in random order"). Press REPEAT [6] on the unit until "FLDR", "SHUF" and ⏮ appear. Press ▶ II [9].
Programed tracks/MP3 files	<ol style="list-style-type: none">Program tracks/MP3 files (see "Creating your own program"). Press REPEAT [6] on the unit until ⏮ and "PGM" appear. Press ▶ II [9].

To cancel Repeat Play
Press REPEAT [**6**] on the unit until ⏮ disappears from the display.

Playing tracks/MP3 files in random order (Shuffle Play)

You can play tracks/MP3 files in random order. When playing an MP3 disc, you can also play MP3 files in a selected folder in random order (Folder Shuffle Play).

- Press CD [**13**] on the unit.

"CD" appears in the display.
- Press MODE [**4**] on the unit until "SHUF" appears in the display.

When you select Folder Shuffle Play (MP3 disc only), press MODE [**4**] on the unit until "FLDR" and "SHUF" appear in the display. Then press □ + or − [**10**] on the unit to select a folder you want.

- Press ▶|**II** [**9**] to start Shuffle Play.

To cancel Shuffle Play

Stop playing first. Then press MODE [**4**] on the unit until "SHUF" disappears from the display.

Tips

• During Shuffle Play, you cannot select the previous track/MP3 file by pressing ◀ [**7**].

• The resume function does not work during Shuffle Play.

Creating your own program (Program Play)

You can arrange the playing order of up to 15 tracks/MP3 files on a CD.

- Press CD [**13**] on the unit.

"CD" appears in the display.
- Press MODE [**4**] on the unit until "PGM" appears in the display.
- Press ◀ or ▶ [**7**] then press DISPLAY•ENTER [**5**] on the unit for the tracks you want to program in the order you want.

For MP3 files, press □ + or − [**10**] first and then press ◀ or ▶ [**7**] and DISPLAY•ENTER [**5**].

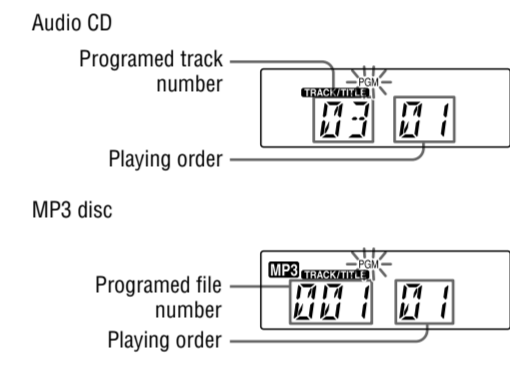

- Press ▶|**II** [**9**] to start Program Play.

To cancel Program Play

Stop playing first. Then press MODE [**4**] on the unit until "PGM" disappears from the display.

To check the order of tracks/MP3 files before play

Press DISPLAY•ENTER [**5**] on the unit. Every time you press the button, the track/MP3 file number appears in the programed order.

To change the current program

Press **■** [**9**] once if the CD is stopped and twice if the CD is playing. The current program will be erased. Then create a new program following the programing procedure.

Tips

- If you try to program 16 tracks/MP3 files or more, "FULL" will appear in the display.
- You can play the same program again, since the program is saved until you open the CD compartment or turn off the unit.
- You can record your own program. After you've created the program, insert a blank tape and press **●** [**13**] on the unit to start recording.
- The resume function does not work during Program Play.

Presetting radio stations

You can store radio stations into the player's memory. You can preset up to 30 radio stations, 20 for FM and 10 for AM in any order.

- Press RADIO•BAND•AUTO PRESET [**13**] on the unit to select the band.
- Hold down RADIO•BAND•AUTO PRESET [**13**] on the unit for 2 seconds until "AUTO" flashes in the display.
- Press DISPLAY•ENTER [**5**] on the unit.

The stations are stored in memory from the lower frequencies to the higher ones.

If a station cannot be preset automatically

You need to preset a station with a weak signal manually.

- Press RADIO•BAND•AUTO PRESET [**13**] on the unit (BAND [**15**] on the remote) to select the band.

- Tune in a station you want.

- Hold down DISPLAY•ENTER [**5**] on the unit for 2 seconds until the preset number flashes in the display.

- Press PRESET + or − [**7**] until the preset number you want for the station flashes in the display.

- Press DISPLAY•ENTER [**5**] on the unit.

The new station replaces the old one.

Tip

The preset radio stations remain in memory even if you unplug the AC power cord or remove the batteries.

Playing preset radio stations

- Press RADIO•BAND•AUTO PRESET [**13**] on the unit (BAND [**15**] on the remote) to select the band.
- Press PRESET + or − [**7**] to tune in the stored station.

Falling asleep to music

- Play the music source you want.
- Press SLEEP [**3**] on the unit to display "SLEEP".
- Press SLEEP [**3**] on the unit to select the minutes until the player goes off automatically.

Each time you press the button, the indication changes as follows:

"AUTO*" → "60MIN" → "30MIN" → "20MIN" → "10MIN" → "OFF".

* When you select "AUTO", the CD or tape stops playing in 90 minutes at most and the player goes off automatically. When you are listening to the radio, the radio goes off in 90 minutes.

If 4 seconds have passed after you pressed SLEEP [**3**] on the unit, the minutes in the display are entered. When the preset time has passed, the player goes off automatically.

To cancel the sleep function

Press POWER [**1**] to turn off the power.

Note

When you are playing a tape using this function: If the tape length of one side is longer than the set time, the player will not go off until the tape reaches the end.

Precautions

Discs that this unit CAN play

• Audio CD

• CD-R/CD-RW (CD-DA*/MP3 files)

* CD-DA is the abbreviation for Compact Disc Digital Audio. It is a recording standard used for Audio CDs.

Discs that this unit CANNOT play

• CD-R/CD-RW other than those recorded in music CD format or MP3 format conforming to ISO9660 Level 1/Level 2 or Joliet

• CD-R/CD-RW of poor recording quality, CD-R/CD-RW that has scratches or is dirty, or CD-R/CD-RW recorded with an incompatible recording device

• CD-R/CD-RW which is finalized incorrectly

Notes on discs

• Before playing, clean the CD with a cleaning cloth. Wipe the CD from the center out. If there is a scratch, dirt or fingerprints on the CD, it may cause tracking error.



• Do not use solvents such as benzine, thinner, commercially available cleaners or anti-static spray intended for vinyl LPs.

• Do not expose the CD to direct sunlight or heat sources such as hot air ducts, nor leave it in a car parked in direct sunlight as there can be a considerable rise in temperature inside the car.

• Do not stick paper or sticker on the CD, nor scratch the surface of the CD.

• After playing, store the CD in its case.

On safety

• As the laser beam used in the CD player section is harmful to the eyes, do not attempt to disassemble the casing. Refer servicing to qualified personnel only.

• Should any solid object or liquid fall into the player, unplug the player, and have it checked by qualified personnel before operating it any further.

• Discs with non-standard shapes (e.g., heart, square, star) cannot be played on this player. Attempting to do so may damage the player. Do not use such discs.

On power sources

• For AC operation, use the supplied AC power cord; do not use any other type.

• Unplug the player from the wall outlet when it is not be used for an extended period of time.

• When the batteries are not to be used, remove them to avoid damage that can be caused by battery leakage or corrosion.

On placement

• Do not leave the player in a location near heat sources, in a place subject to direct sunlight, excessive dust or mechanical shock or in a car subject to the direct rays of the sun.

• Do not place the player on an inclined or unstable place.

• Do not place anything within 10 mm of the side of the cabinet. The ventilation holes must be unobstructed for the player to operate properly and prolong the life of its components.

• Since a strong magnet is used for the speakers, keep personal credit cards using magnetic coding or spring-wound watches away from the player to prevent possible damage from the magnet.

On operation

• If the player is brought directly from a cold to a warm location, or is placed in a very damp room, moisture may condense on the lens inside the CD player section. Should this occur, the player will not operate properly. In this case, remove the CD and wait about an hour for the moisture to evaporate.

• If the player has not been used for a long time, set it in the playback mode to warm it up for a few minutes before inserting a cassette.

Notes on cassettes

• Break off the cassette tab from side A or B to prevent accidental recording. If you want to reuse the tape for recording, cover the broken tab with adhesive tape.

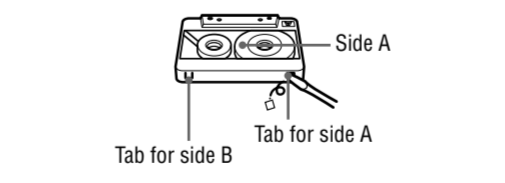

• The use of a cassette with more than 90 minutes of play time is not recommended except for long, continuous recording or playback.

Cleaning the cabinet

• Clean the cabinet, panel and controls with a soft cloth slightly moistened with a mild detergent solution. Do not use any type of abrasive pad, scouring powder, or solvent, such as alcohol or benzine.

If you have any questions or problems concerning your player, please consult your nearest Sony dealer.

Troubleshooting

General

The power is not on.

• Connect the AC power cord to the wall outlet securely.

• Make sure the batteries are inserted correctly.

• Replace all the batteries with new ones if they are weak.

• You cannot turn on the player with the remote when you operate the player on batteries.

There is no audio.

• Unplug the headphones when listening through speakers.

Noise is heard.

• Someone is using a portable telephone or other equipment that emits radio waves near the player.
→ Move the portable telephone, etc., away from the player.

CD/MP3 player

The CD does not play or "NO DISC" is displayed even when a CD is in place.

• Place the CD with the label surface up.

• Clean the CD.

• Take out the CD and leave the CD compartment open for about an hour to dry moisture condensation.

• The CD-R/CD-RW is blank.

• There is a problem with the quality of the CD-R/ CD-RW, recording device or application software.

• Replace all the batteries with new ones if they are weak.

The sound drops out.

• Reduce the volume.

• Clean the CD, or replace it if the CD is badly damaged.

• Place the player in a location free from vibration.

• Clean the lens with a commercially available blower.

• The sound may drop out or noise may be heard when using poor quality CD-R/CD-RW or if there is a problem with the recording device or application software.

Starting playback takes more time than usual.

• The following discs take a longer time to start playback.
– a disc recorded with a complicated tree structure.
– a disc that has not been finalized (a disc to which data can be added).
– a disc that has many folders or non-MP3 files.

Radio

Reception is poor.

• Reorient the antenna to improve FM reception.



• Reorient the player itself to improve AM reception.

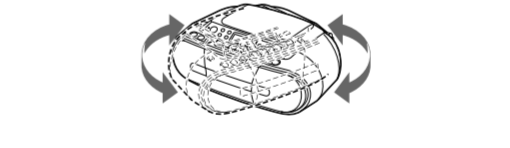

The audio is weak or has poor quality.

• Replace all the batteries with new ones if they are weak.

• Move the player away from the TV.

• If you are using the remote while listening to AM radio, noise may be heard.

The picture of your TV becomes unstable.

• If you are listening to an FM program near the TV with an indoor antenna, move the player away from the TV.

Tape player

The tape does not move when you press an operation button.

• Close the cassette compartment securely.

The ● button [12**] does not function or the tape does not play or record.**

• Make sure the safety tab on the cassette is in place.

Poor or distorted playback, recording or erasing quality.

• Clean the heads by using dry- or wet-type cleaning cassette (available separately) after every 10 hours of use, before you start an important recording, or after playing an old tape. Failure to clean the tape heads can cause degraded sound quality or an inability of the unit to record or play tapes. For details, refer to the instructions of the cleaning cassette.

• The TYPE II (high position) or TYPE IV (metal) tape is being used. Use TYPE I (normal) tape only.

• Demagnetize the heads using a commercially available tape head demagnetizer.

• Replace all the batteries with new ones if they are weak.

Remote

The remote does not function.

• Replace all the batteries in the remote with new ones if they are weak.

• Make sure that you are pointing the remote at the remote sensor on the player.

• Remove any obstacles in the path of the remote and the player.

• Make sure the remote sensor is not exposed to strong light such as direct sunlight or fluorescent lamp light.

• Move closer to the player when using the remote.

After trying the remedies, if you still have problems, unplug the AC power cord or remove all the batteries. After all the indications in the display disappear, plug the AC power cord or insert the batteries again. If the problem persists, please consult your nearest Sony dealer.