

SONY

3-856-309-11 (1)

Portable VIDEO CD Player

Operating Instructions

æB@C/AE—

EN

C



D-V500

©1996 by Sony Corporation

WARNING

To prevent fire or shock hazard, do not expose the unit to rain or moisture.

To avoid electrical shock, do not open the cabinet. Refer servicing to qualified personnel only.

Welcome!

Thank you for purchasing the Sony VIDEO CD Player. Before operating your player, please read this manual and retain it for future reference.

This player can play the following discs:

- **VIDEO CD**

Disc logo



Contents Audio & video signals

- **Audio CD**

Disc logo



Contents Audio signals only

There are 2 types of discs in size — 12 cm and 8 cm. Their longest play time is 74 and 20 minutes respectively. The actual play time, however, varies among the discs.

Note on VIDEO CDs

This player conforms to Version 1.1 and 2.0 of VIDEO CD standards. You can enjoy two kinds of playback according to the disc type.

Disc type	You can
VIDEO CDs without PBC functions (Version 1.1)	Enjoy video playback (moving pictures) as well as music.
VIDEO CDs with PBC functions (Version 2.0)	Play interactive software using menus displayed on the TV screen, in addition to the video playback function.

Table of contents

Playing a VIDEO CD	4
Playing an audio CD	6
Enjoying PBC Functions	8
Playing VIDEO CDs with PBC functions (PBC Playback)	8
PBC playback flow	9
Locating scenes directly using the scene numbers (Scene Search) ...	10
Locating a Scene or Track You Want	11
Displaying the operating status on the TV screen	11
Locating a specific scene or track	12
Locating a particular point in a scene or track	12
To locate a particular point using the video index (Video Index Play)	13
Playing CDs in Various Modes	14
Playing repeatedly (Repeat Play)	14
Playing only your favorite tracks (Intro Program Play)	14
Playing in random order (Shuffle Play)	15
Creating your own program (RMS—Program Play)	16
Playing multiplex discs	17
Using other functions	18
To prevent unintended operation (HOLD function)	18
To resume playing from the point you stopped (Resume Play) .	18
Operating with the remote	19
Connecting to other stereo equipment	20
About Power Sources	20
Using the rechargeable lithium ion battery	20
Additional Information	22
Precautions	22
Troubleshooting	23
Specifications	24
Maintenance	24
Glossary	25
Parts identification	26

EN

Playing a VIDEO CD

You can play back a VIDEO CD, using supplied the AC power adaptor.
You can also use the rechargeable battery (lithium ion battery). (See
“About Power Sources” on page 20.)
To produce color pictures normally, you need to set the color system
properly according to the connected TV.

1 Connect

To connect a TV equipped with audio/video input jacks

Use the supplied AV monitor cord.

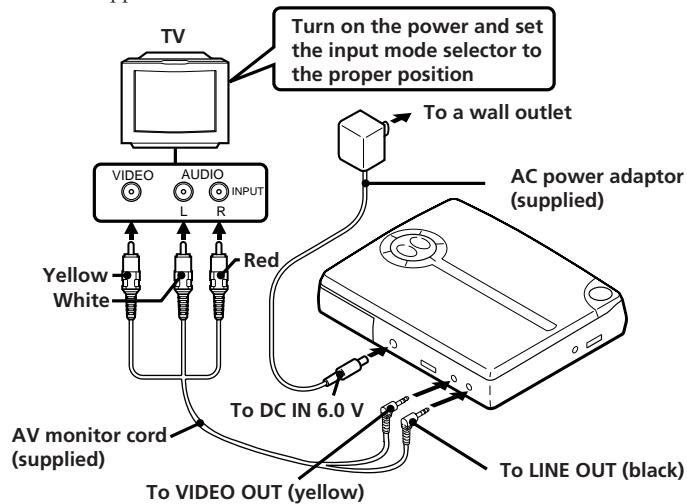

To connect a portable TV equipped with the audio/video input jack of the stereo mini type

Use the RK-G136HG or RK-G136* (not supplied) connecting cord.

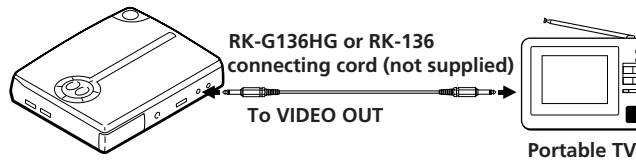

* Your dealer may not supply these recommended cords. Please check with your dealer about the cords of this type available in your country.

2 Set the color system according to your TV

Normally, set the Color System Switch to AUTO.
If abnormal or strange color pictures appear, set it to NTSC or PAL, whichever reproduces normal color pictures.

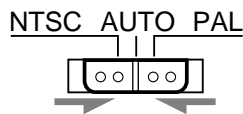

3 Place a VIDEO CD

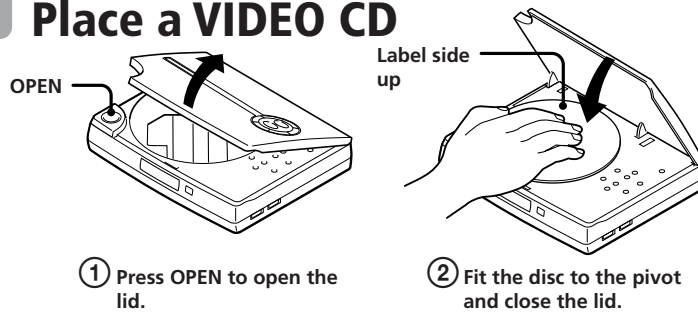

① Press OPEN to open the lid.

② Fit the disc to the pivot and close the lid.

4 Play

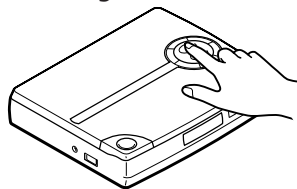

To play the disc with PBC functions, see page 8.

- ① Press **▶**.
The disc play starts.
- ② Adjust the playback volume using the remote. (You cannot adjust the TV volume using the player's volume control.)

To	Press
Pause	PAUSE (or on the remote).
Resume play after pause	▶ (or PAUSE again).

To stop playing, press **POWER OFF** **■** (or **■** on the remote).
The player also turns off.

To connect to other stereo equipment

If you connect the player to the stereo equipment, you can enjoy better sound quality. For more details, see "Connecting to other stereo equipment" (page 20).

Playing an audio CD

1 Connect

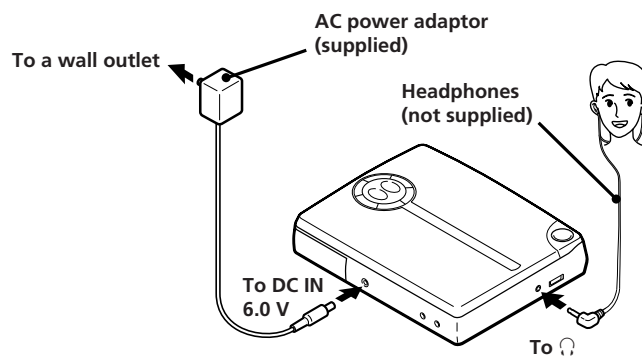

2 Place an audio CD

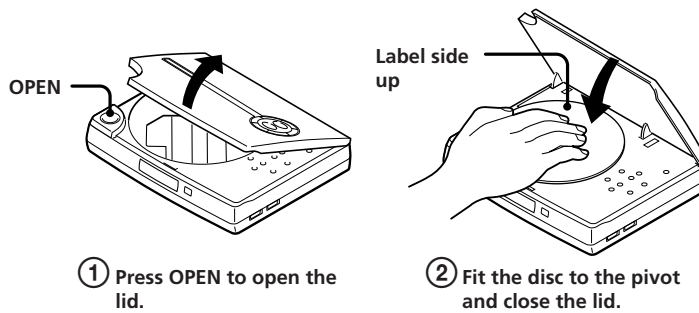

3 Play

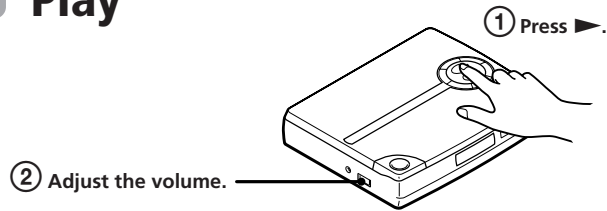

To stop playing, press POWER OFF ■ (or ■ on the remote).
The player also turns off.

To	Press
Pause	PAUSE ■■ (or ■■ on the remote).
Resume play after pause	► (or PAUSE ■■ again).

Notes on display

- When you press ► with RESUME set to OFF, the total number of tracks in the disc and the total playing time appear for 2 seconds.
- During play, the track number and the elapsed playing time of the current track appear.
- During pause, the elapsed playing time flashes.
- Between tracks, the time to the beginning of the next track will appear.

Notes on handling discs

- To keep the disc clean, handle it by its edge. Do not touch the surface.
- Do not stick paper or tape onto the disc.
- Do not expose the disc to direct sunlight or heat sources such as hot air ducts. Do not leave the disc in a car parked in direct sunlight.

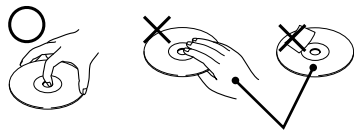

Not these ways

To remove the disc

Remove the disc while pressing the pivot.

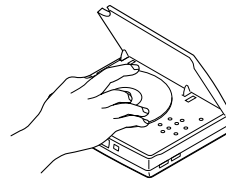

To insert batteries into the remote

Insert two R6 (size AA) batteries by matching the + and - on the batteries.

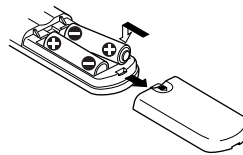

▶Enjoying PBC Functions

Playing VIDEO CDs with PBC functions (PBC Playback)

Using the PBC functions, you can play a VIDEO CD with PBC functions (Version 2.0) (simple interactive software, software with search functions, etc.) Refer also to the instructions supplied with the disc, as the operating procedure may differ according to the discs.

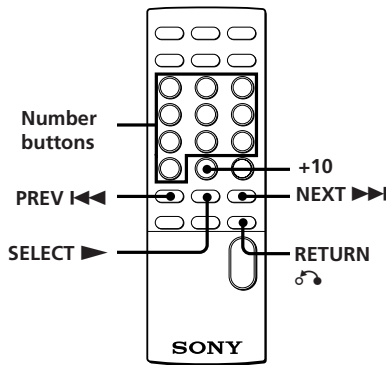

- 1 Insert a VIDEO CD with PBC functions (see page 5).
- 2 Press SELECT ▶. PBC playback starts, and the menu appears on the TV screen. "SELECT" flashes on the display of this player.

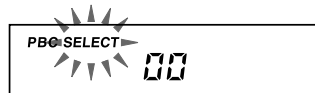

- 3 Press the number buttons to select item number of the menu you want to play.

To select item number 3, press 3.
To select an item number over 11, press +10 repeatedly, then the corresponding number button to enter the one's digit.
Examples:
For 12: +10, then 2
For 24: +10, +10, then 4
For 30: +10, +10, then 10

On the player

Press MENU +/- to select the item number, then press ▶.

- 4 Repeat the above procedure, following the instruction shown on the menu.

When	Press
You want to select an item number	Number button of the item you want on the remote.
	On the player: MENU +/- to select the item number, then ▶.
"SELECT" is flashing on the TV screen while playing back moving pictures	Number buttons or MENU +/- and ▶ to select another scene even while playing back moving pictures.
You want to go back to the previous menus	RETURN ↶. (The actual operation varies among the discs. Refer to the instructions supplied with the discs.)

To play the disc in normal play mode and cancel playback using PBC functions

Press PBC ON/OFF on the remote so that "PBC OFF" appears on the TV screen, "PBC" disappears from the display, and normal playback starts (in the sequence of the track numbers). In this case, you cannot play back still pictures including menu screens. To resume playback using PBC functions, press the button again.

PBC playback flow

Below is an example of PBC playback. Refer also to the instructions supplied with the discs, as the operating procedures may differ according to the discs.

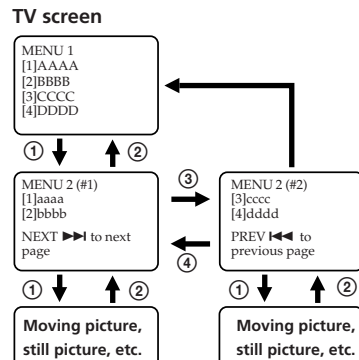

- ① To select the item number:
Press the number button of the item number you want using the remote, or press MENU +/- to select the item number, then ►.
- ② To go to the previous menu:
Press RETURN ↵.
- ③ To go to the next page of the menu:
Press NEXT ►►.
- ④ To go back to the previous page of the menu:
Press PREV ◄◄.

Locating scenes directly using the scene numbers (Scene Search)

On VIDEO CDs with PBC functions, the menus, moving pictures and still pictures are divided into "scenes" and each scene is assigned with a scene number.

Check the current scene number by displaying it on the TV screen during playback (see page 11). Be sure to remember the scene number you want to start playing from.

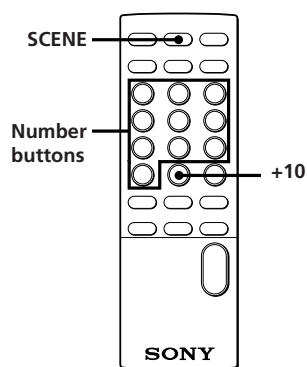

- 1 Press SCENE while playing a disc. "SCENE" appears on the TV screen.

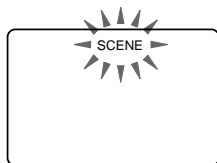

- 2 Press the number buttons and +10 to select the scene number you want. The selected scene number appears on the TV screen.

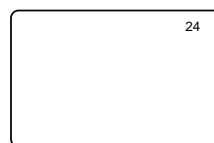

To select a scene number over 11, press +10 repeatedly, then the corresponding number button to enter the one's digit.

Examples:

For 12: +10, then 2

For 24: +10, +10, then 4

For 30: +10, +10, then 10

If you have made a mistake

Repeat the same procedure from Step 1 again.

Notes

- Some discs do not allow you to start playing from a particular scene. If you select a scene number while playing a disc of this type, the selected scene number disappears from the TV screen, and the player keeps playing the current scene.
- Some discs do not display the selected scene on the TV screen.

► Locating a Scene or Track You Want

Displaying the operating status on the TV screen

You can check the operating status of the player and the information about the disc on the TV screen.

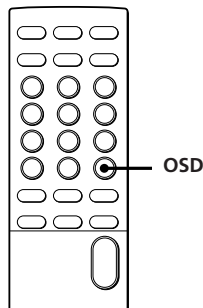

Press OSD.

Each time you press the button, the OSD (On-Screen Display) mode changes as follows:



When "OSD 1" is selected, the operating status appears for a few seconds with the respective button pressed. On the other hand, when "OSD 2" is selected, the following information appears on the display.

■ While playing a VIDEO CD without PBC functions/while playing back with PBC OFF

Operating status ("►" during play; "||" during pause; "►►" during fast forwarding; "◀◀" during fast rewinding) appears.

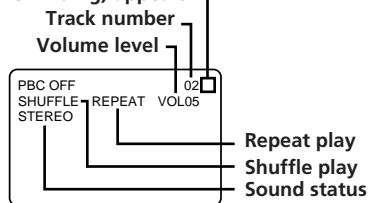

■ While playing a VIDEO CD with PBC functions

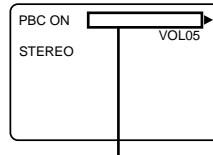

Scene number or video index number

To check the scene number of the scene you are watching

Press SCENE after selecting "OSD 2" by pressing OSD.

To check the video index number of the scene you are watching

Press V-INDEX after selecting "OSD 2" by pressing OSD.

■ While playing an audio CD

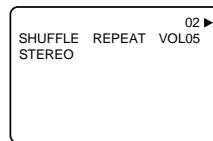

Notes

- When you record the playback picture of this player on another VCR, etc., be sure to select "OSD OFF". Otherwise, the display information is also recorded on the VCR.
- When you want to display the operating status while playing an audio CD, make sure to connect the AV monitor cord before turning the power on.
- The OSD mode remains unchanged when you turn off the player by pressing POWER OFF (or on the remote). However, if you unplug the AC power adaptor or remove the rechargeable lithium ion battery, the OSD mode is turned off ("OSD OFF").

Locating a specific scene or track

You can quickly locate any scene or track while playing a disc using the PREV ◀◀ / NEXT ▶▶ (AMS: Automatic Music Sensor) or number buttons.

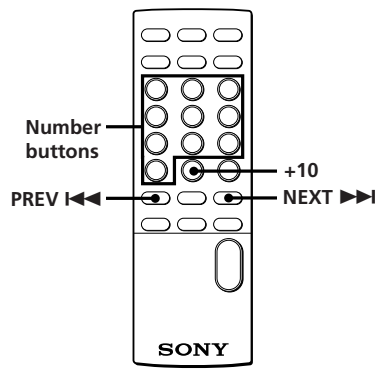

To locate	Press
The next or succeeding scenes or tracks (AMS)	NEXT ▶▶ repeatedly until you find the scene or track
The current or preceding scenes or tracks (AMS)	PREV ◀◀ repeatedly until you find the scene or track
A specific track directly	Number button of the track

To directly locate a track number over 11

Press +10 repeatedly, then the corresponding number button to enter the one's digit.

Examples:

For 12: +10, then 2

For 24: +10, +10, then 4

For 30: +10, +10, then 10

Note

These buttons work as PBC operating buttons while playing a VIDEO CD with PBC functions.

Locating a particular point in a scene or track

You can also locate a particular point in a scene or track while playing a disc.

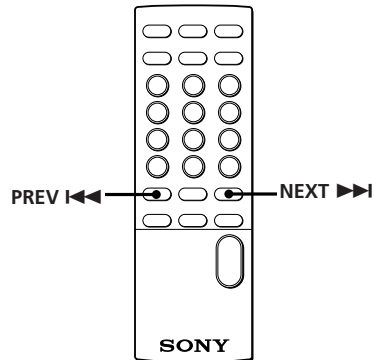

Continue to the next page →

To locate a point	Press
While monitoring the picture or listening to the sound	PREV ◀◀ or NEXT ▶▶ and hold it down until you find the point. (Sound cannot be reproduced correctly while playing a VIDEO CD.)

Notes

- During PBC playback, this function is available only while playing back moving pictures.
- While playing a VIDEO CD, the picture may be distorted during the search operation.

To locate a particular point using the video index (Video Index Play)

You can locate particular points you want within the same track when playing back a VIDEO CD with video indexes recorded.

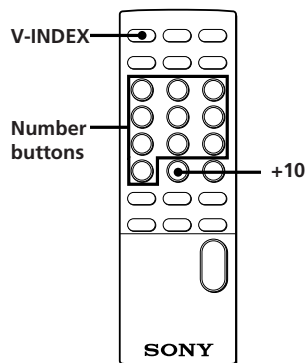

To locate a point	Press
While playing a track, select the video index number directly.	1 V-INDEX. 2 Then number buttons to select the video index number.

Display

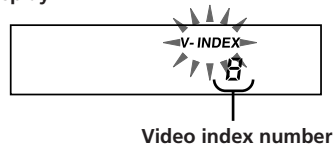

TV screen (In "OSD 2" mode)

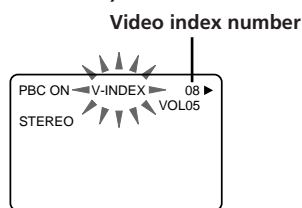

To directly locate an video index number over 11

Press +10 repeatedly, then the corresponding number button to enter the one's digit.

Examples:

- For 12: +10, then 2
- For 24: +10, +10, then 4
- For 30: +10, +10, then 10

To stop video index play

Press V-INDEX again.

Notes

- You cannot use video index play in a track or on a disc without video indexes recorded.
- You cannot search video indexes in different tracks.

▶Playing CDs in Various Modes

Playing repeatedly (Repeat Play)

You can play a disc or a single track repeatedly.

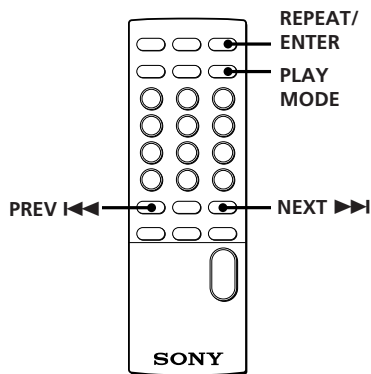

To repeat all the tracks on a disc

Press REPEAT/ENTER while playing a disc.
↶ appears.

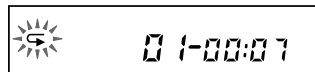

- During intro program play, shuffle play and program play, you can also repeat the play by pressing REPEAT/ENTER.
- To cancel repeat play, press REPEAT/ENTER again.

To repeat the current track

1 While playing a track you want, press REPEAT/ENTER.
↶ appears.

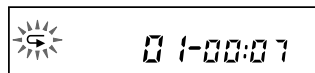

2 Press PLAY MODE repeatedly until "1" appears.

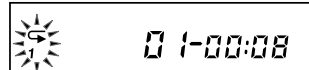

To cancel repeat play, press REPEAT/ENTER again.

To repeat another track, press PREV ◀◀ or NEXT ▶▶.

Note

This function is not available during PBC playback (to set PBC OFF, see page 9).

Playing only your favorite tracks (Intro Program Play)

You can select your favorite tracks while playing the first 15 seconds of all tracks, and then play back only the tracks you select.

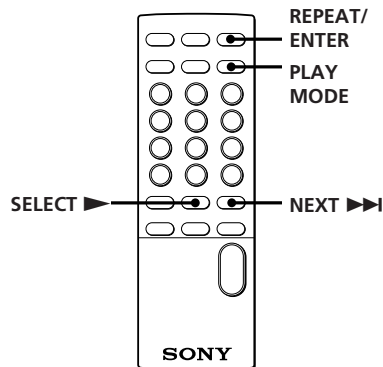

Continue to the next page →

- 1 While playing a disc, press PLAY MODE repeatedly until "INTRO PGM" flashes.

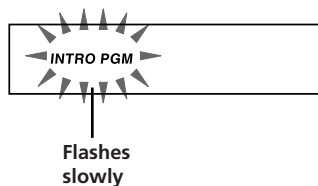

- 2 Press SELECT ►. "INTRO PGM" flashes faster, and all tracks are played for 15 seconds, one after another.
- 3 Press REPEAT/ENTER while the track you want to play back later is being played. If you want to skip the track, press NEXT ►►.

When the last track in the disc has been played, "INTRO PGM" stops flashing and then the player starts playing only the tracks you have selected. To stop intro program play, press PLAY MODE repeatedly until "INTRO PGM" disappears.

Notes

- If you select a track directly by pressing the number button (see page 12), intro program play will be canceled.
- This function is not available during PBC playback (to set PBC OFF, see page 9).

Playing in random order (Shuffle Play)

You can have the player "shuffle" tracks and play them at random.

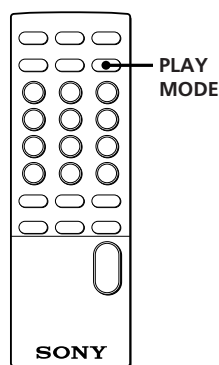

Press PLAY MODE repeatedly during play until "SHUFFLE" appears on the display.

Shuffle play starts from the next track and plays back every track once.

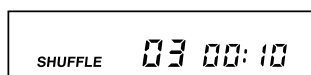

To stop shuffle play, press PLAY MODE repeatedly until "SHUFFLE" disappears.

Notes

- During shuffle play, you cannot go back to the previous tracks by pressing PREV ◀◀.
- If you select a track directly by pressing the number button (see page 12), shuffle play will be canceled.
- This function is not available during PBC playback (to set PBC OFF, see page 9).

Creating your own program (RMS*—Program Play)

You can arrange the order of the tracks on the disc and create your own program. The program can contain up to 22 tracks.

*RMS is the abbreviation of Random Music Sensor.

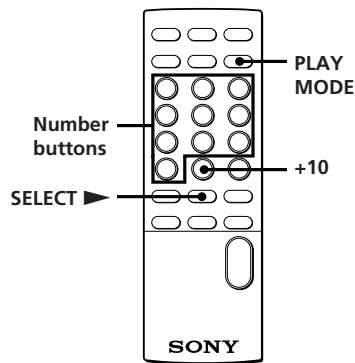

- 1 Press PLAY MODE repeatedly during play until "RMS" flashes.

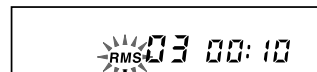

Flashing

- 2 Press the number buttons or +10 to select the track you want to program. Track number and the order of the playback appear.

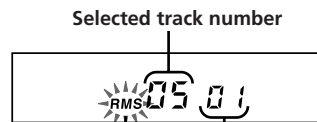

Flashing The order of the playback

To select a track number over 11, press +10 repeatedly, then the corresponding number button to enter the one's digit.

Examples:

For 12: +10, then 2

For 24: +10, +10, then 4

For 30: +10, +10, then 10

- 3 Repeat Step 2 to program your favorite tracks.

- 4 Press SELECT ►. "RMS" stops flashing and program play starts in the order of the tracks you have selected.

To stop program play, press PLAY MODE repeatedly until "RMS" disappears.

To check the track order

Press REPEAT/ENTER before going to Step 4. Each time you press the button, the display shows the track number in the programmed order. After the last track in the program has been displayed, the first track number in the program appears again.

To check the total number of selected tracks and the total playing time

Press REPEAT/ENTER for more than one second before going to Step 4. While holding the button, the total number of the tracks and the total playing time appear on the display.

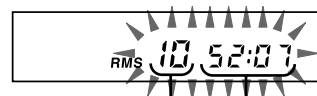

Total number of the selected tracks

Total playing time

Notes

- If you program more than 22 tracks, the first selected tracks are replaced by those tracks newly selected.
- “- : -” appears instead of the total playing time;
 - if you select a track number over 31.
 - if the total playing time exceeds 100 minutes.
- If you select a track directly by pressing the number button (see page 12), program play will be canceled.
- This function is not available during PBC playback (to set PBC OFF, see page 9).
- You cannot make a program using the video indexes.

Playing multiplex discs

On multiplex discs, different sounds are recorded for the left and right channels. You can select either the left or the right channel and hear the sound of the selected channel. In this case, stereo effect will be lost.

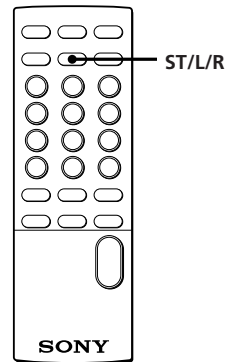

Press ST/L/R while playing a multiplex disc.

Each time you press the button, the indication and sound you hear change as follows:

Press	Indication*	You will hear
Once	L	Left channel sound
Twice	R	Right channel sound
Three times	STEREO	Stereo sound

* When “OSD 1” or “OSD 2” is selected for the OSD mode.

Using other functions

To prevent unintended operation (HOLD function)

You can restrict the button operation using the HOLD switch. This is convenient when you carry the player with you.

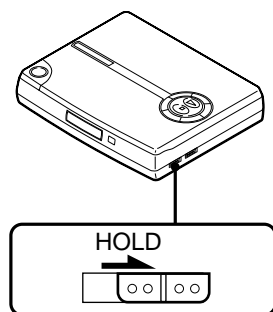

Slide HOLD in the direction (right) of the arrow.

The buttons on the player do not function.

However, you can use the remote to operate the player even with the HOLD function activated.

To use the buttons on the player, slide HOLD to the opposite direction (left).

To resume playing from the point you stopped (Resume Play)

Normally, every time you stop and play, playing starts from the beginning of the disc. Resume play, however, lets you listen to from the point where you last turned off the player.

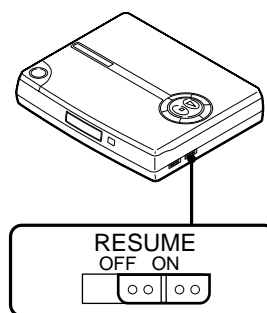

Set RESUME to ON.

To cancel resume play, set RESUME to OFF.

Notes

- When you open the lid, the memorized resume point is erased regardless of the setting of the RESUME switch. When you play the disc the next time, it is played from the beginning.
- The resume point may be inaccurate by about 30 seconds.
- This function is not available during PBC playback (to set PBC OFF, see page 9).

Operating with the remote

To adjust the volume

You can adjust the TV volume and headphones volume (within the range from 01 to 10) using the remote.

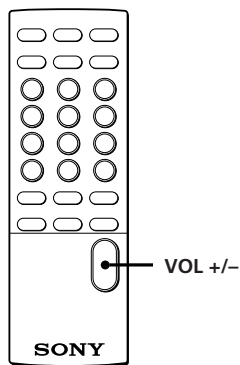

Press VOL +/-.
When you press VOL +, the volume increases.
When you press VOL -, the volume decreases.

Note

- You can turn on the player by pressing SELECT ► on the remote within about 10 minutes after you turn it off. If 10 minutes have already passed, press ► on the player to turn it on.
- Do not expose the remote sensor to direct sunlight or lighting apparatuses.
- Remove all the obstacles between the remote sensor and the remote.

Connecting to other stereo equipment

You can play back a disc through other stereo equipment or record a disc on a cassette tape or video tape. Refer to the instruction manual supplied with other equipment for details. Before making connections, turn off each equipment.

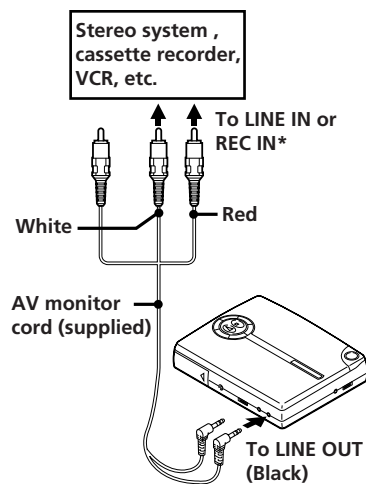

* If other stereo equipment has neither the LINE IN jack nor the REC IN jacks, connect to the MIC jack with the RK-G134 connecting cord (not supplied).

Note

- When you play a VIDEO CD, connect the video connecting cord to the VIDEO OUT jack.
- Before you play a disc, turn down the volume of the connected equipment so as not to damage the speakers.

About Power Sources Using the rechargeable lithium ion battery

Charge the rechargeable lithium ion battery before using it for the first time.

- 1 Open the lid of the battery compartment.

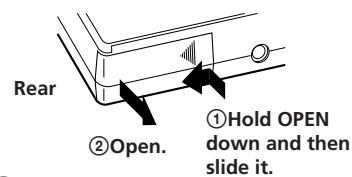

- 2 Insert the rechargeable lithium ion battery as illustrated until it is locked by the battery lock lever, and close the lid.

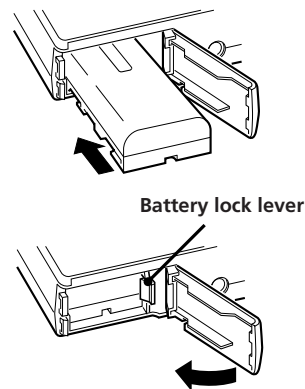

To remove the rechargeable lithium ion battery

Open the lid, then press the battery lock lever in the direction of the arrow.

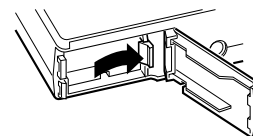

- 3** Connect the AC power adaptor and charge for about 8 hours. "CHG" appears and remains on the display until charging is completed.

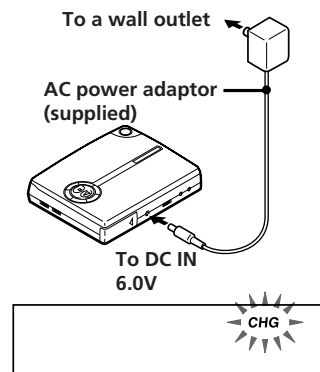

- 4** When the battery is fully charged, disconnect the AC power adaptor.

When to charge the battery

When the battery is used up, "⏻" appears on the display. Charge the rechargeable battery.



Battery life

When you use the player on a flat and stable place.

(Hours)		
TYPE	CD	VIDEO CD
Battery life	Approx. 12.0	Approx. 4.0

Notes

- The battery is used up faster if the video connecting cord is left connected to the VIDEO OUT jack while playing an audio CD. Disconnect the video connecting cord from the VIDEO OUT jack before turning on the power when playing an audio CD.
- Charging time varies depending on how the rechargeable battery is used.
- If the battery is new or has not been used for a long time, it may not be charged completely until you charge and discharge it several times.

► **Additional Information**

Precautions

On safety

- The laser used in this unit is harmful to your eyes. Do not disassemble the unit.
- Do not put any foreign objects in the DC IN 6.0V (external power input) jack.
- Should any solid objects or liquid fall into the unit, unplug it and have it checked by qualified personnel before operating it any further.

On power sources

- When you are not using the unit for a long time, disconnect all power sources from the unit.
- The nameplate indicating operating voltage, power consumption, etc. is located on the bottom.

On the AC power adaptor

- Use only the supplied AC power adaptor. Do not use any other AC power adaptor.

Polarity of the plug (EIAJ standards)



- To unplug the AC power adaptor from the wall outlet, grasp the adaptor itself, do not pull its cord.

On rechargeable batteries

- Do not throw the batteries into fire.
- Do not carry the rechargeable batteries with coins or other metallic objects. It can generate heat if the positive and negative terminals of the batteries accidentally comes into contact with a metallic object.

On the unit

- Keep the lens on the unit clean and do not touch it. If you do so, the lens may be damaged and the unit will not operate properly.
- Do not put any heavy object on top of the unit. The unit and the disc may be damaged.
- Do not leave the unit in a location near heat sources, or in a place subject to direct sunlight, excessive dust or sand, moisture, rain, mechanical shock, unlevelled surface, or in a car with its windows closed.
- If the unit causes interference to the radio or television reception, turn off the unit or move it away from the radio or television.
- Do not wrap the unit in a cloth or blanket during use as it may cause malfunction or serious accidents.

On headphones

Road safety

Do not use headphones while driving, cycling, or operating any motorized vehicle. It may create a traffic hazard and is illegal in some areas. It can also be potentially dangerous to play your headsets at high volume while walking, especially at pedestrian crossings. You should exercise extreme caution or discontinue use in potentially hazardous situations.

Preventing hearing damage

Avoid using headphones at high volume. Hearing experts advise against continuous, loud and extended play. If you experience a ringing in your ears, reduce volume or discontinue use.

Caring for others

Keep the volume at a moderate level. This will allow you to hear outside sounds and to be considerate to the people around you.

Troubleshooting

Should any problem persist after you have checked the following, consult your nearest Sony dealer.

The disc does not play or "no disc" appears on the display though a disc is placed in the unit.

- ➔ The disc is dirty or defective.
- ➔ Insert the disc with the label side up.
- ➔ Moisture condensation has occurred.
Leave the unit unused for several hours until the moisture evaporates.
- ➔ The lens is dirty.
- ➔ Close the lid of the unit and the battery compartment firmly.
- ➔ Make sure the rechargeable battery is inserted correctly.
- ➔ Connect the AC power adaptor to a wall outlet securely.

No sound, or noise is heard.

- ➔ Plugs are not connected firmly.
- ➔ Plugs are dirty. Clean the plugs with a dry soft cloth periodically.

Sound seems to lose the stereo effect and becomes monaural.

- ➔ Press ST/L/R on the remote repeatedly until the stereo effect is restored.

"Hold" appears on the display when you press a button.

- ➔ The button operation is restricted. Slide HOLD to the left.

No picture appears on the TV screen.

- ➔ Make sure the TV is turned on.
- ➔ Make sure you select the correct video input on the TV.
- ➔ Connect the video connecting cord correctly.
- ➔ An audio CD is being played.
- ➔ You have connected the AV monitor cord while playing an audio CD. Connect the AV monitor cord before turning the power on.
- ➔ Close the lid of the player and the battery compartment firmly.
- ➔ Make sure the following mark is on the disc.





- ➔ You may not play back some illegally duplicated discs though they have the above mark printed. In this case, consult the shops where you bought the discs.

Picture is distorted.

- ➔ When you pause or use search, picture is distorted. This is not a malfunction.
- ➔ The disc is dirty or defective.
- ➔ The color system you have selected for this player is not the same as the one the disc is recorded with.

The remote does not function.

- ➔ You can turn on the player by pressing SELECT  on the remote within about 10 minutes after you turn it off. If 10 minutes have already passed, press  on the player to turn it on.
- ➔ Remove any obstacles between the remote and the remote sensor.
- ➔ Replace all the batteries in the remote with new ones if they are weak.

Specifications

System

Compact disc digital audio/video system

Laser diode properties

Material: GaAlAs
Wavelength: $\lambda=780$ nm
Emission duration: Continuous
Laser output power: Less than 44.6 μ W*

* This output is the value measured at a distance of 200 mm from the objective lens surface on the optical pick-up block with 7 mm aperture.

Error correction

Sony Super Strategy Cross Interleave Reed Solomon Code

D-A conversion

1-bit

Channel number

2 channels

Frequency response

20 - 20,000 Hz ± 3 dB (measured by EIAJ CP-307)

Output (at 6.0 V input level)

Headphones (stereo minijack)
7 mW + 7 mW at 16 ohms
Line output (stereo minijack)
Output level 0.7 V rms at 47 kilohms
Recommended load impedance over 10 kilohms
Video output (minijack)
Output level 1Vp-p at 75 ohms
Recommended load impedance over 75 ohms

General

Power requirements

- Sony NP-F530 rechargeable battery: 7.2 V DC, Lithium ion, 1350 mAh
- AC power adaptor (DC IN 6.0 V jack):
120 V, 60 Hz
220 - 230 V, 50/60 Hz
100 - 240 V, 50/60 Hz
(AC power required differs depending on where you purchased the player.)

Dimensions (w/h/d) (incl. projecting parts and controls)

Approx. 177.0 x 34.8 x 145.0 mm
(7 x 1 $\frac{3}{8}$ x 5 $\frac{3}{4}$ in.)

Mass (excl. rechargeable batteries)

Approx. 400 g (14 oz)
Approx. 510 g (1 lb 2 oz)(incl. rechargeable lithium ion battery and a disc)

Operating temperature

5°C - 35°C (41°F - 95°F)

Supplied accessories

AC power adaptor (1)
AV monitor cord (1)
Remote control unit (remote) (1)

Design and specifications are subject to change without notice.

Recommended accessories

Rechargeable lithium ion battery NP-F530

Your dealer may not handle some of the above listed accessories. Check with the dealer for detailed information about the accessories in your country.

Maintenance

To clean the lens

Clean the lens with the lens cleaning kit KK-DM1.

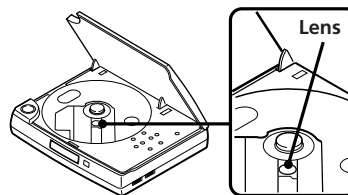

To clean the casing

Use a soft cloth slightly moistened in water or a mild detergent solution. Do not use alcohol, benzine or thinner.

Glossary

Index

Markings assigned for particular points to divide a track or a whole disc. By using indexes you can easily find particular points you want. There are two types of index—one is for audio CDs and the other is for VIDEO CDs. This player only conforms to the latter type of index, called "Video Index."

PBC Playback

Playback using the menus recorded on VIDEO CDs with PBC functions. You can enjoy simple interactive operations using the PBC Playback.

Playback Control (PBC)

Signals encoded on VIDEO CDs (Version 2.0) to control playback. By using menus recorded on VIDEO CDs with PBC functions, you can enjoy playing simple interactive software, software with search functions, and so on. When you insert a VIDEO CD with PBC functions on this player, "PBC" appears on the display.

Scene

Markings differentiating still pictures, moving picture or menus recorded on VIDEO CDs with PBC functions. Each scene is assigned with a number, called "Scene Number."

Track

Markings differentiating pictures or songs recorded on VIDEO CDs or audio CDs. Each track is assigned with a number, called "Track Number."

VIDEO CD

A compact disc containing moving pictures. Picture data is compressed to 1/120th of the original data in the MPEG 1 format (one of the worldwide standards of digital compression technologies) and recorded on a disc. A 12 cm VIDEO CD can reproduce up to 74 minute's length of moving pictures. Audio data is also compressed so that a VIDEO CD can contain 6 times as much audio data as an audio CD. There are 2 versions of VIDEO CDs.

- Version 1.1: You can play only moving pictures and sounds.
- Version 2.0: You can play still pictures and enjoy PBC functions.

Parts identification

For explanation of the use of each part, see pages indicated in parentheses.

Main unit

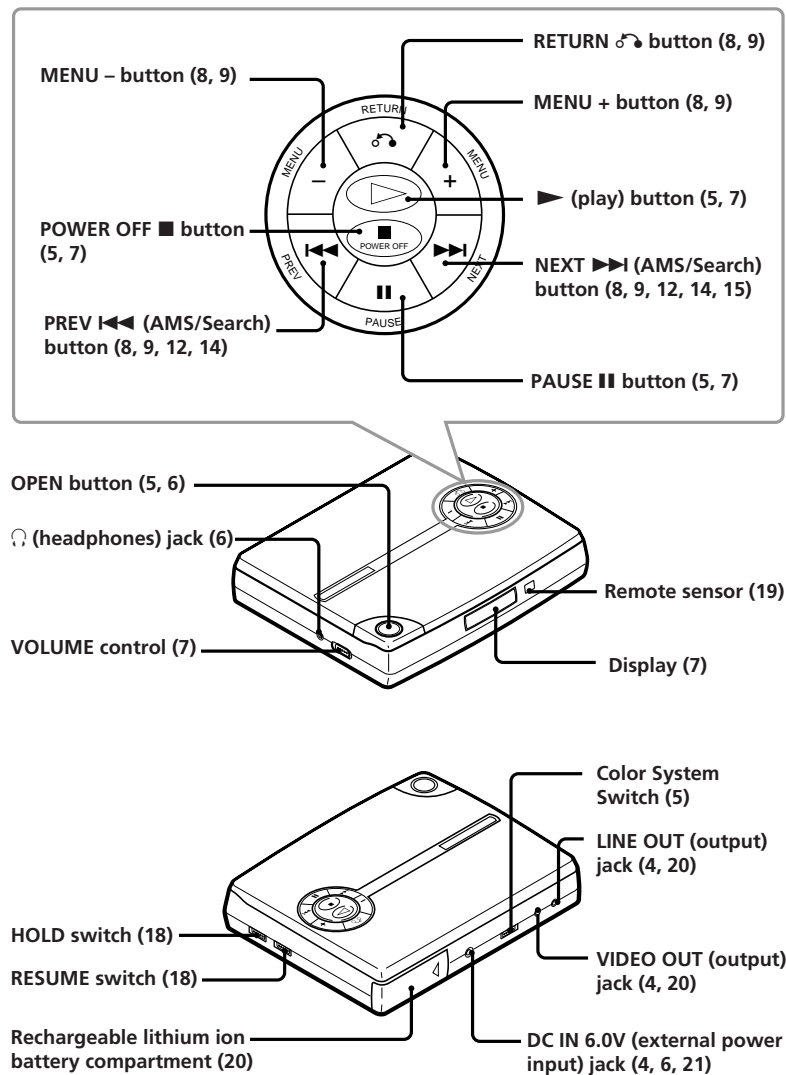

Remote control

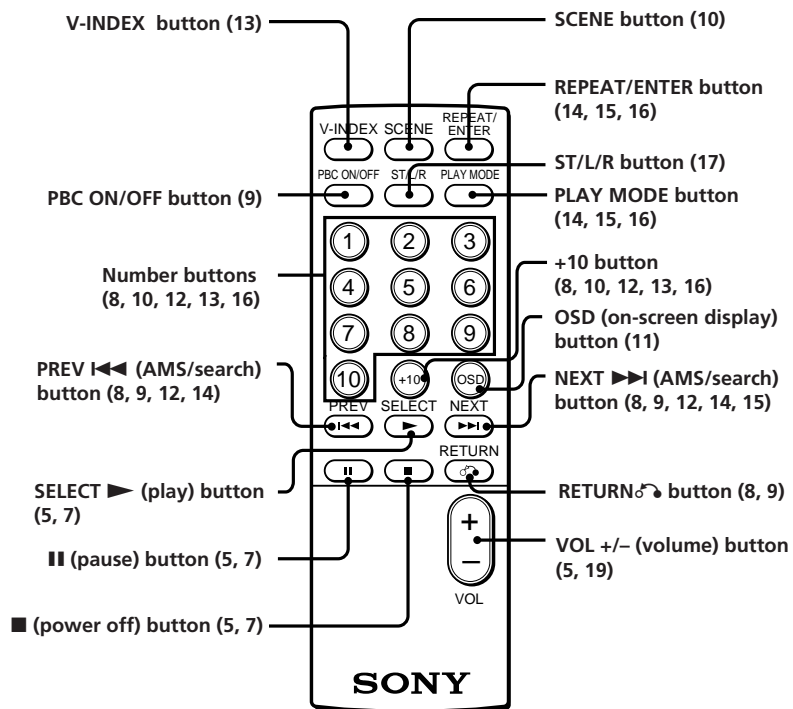

Sony Corporation Printed in Japan



Sony D-V500 (E)_3-856-309-11(1) []

fμβi

“§RæSÓ§RaCCEj BK
f q'M-§ ±NªææD'BO
©CE®, °E-

-§ æ'¶ª¥ }æ~¶fi°M
•H BKæD®i qzª - ° -•É
±M ~§H ° B z -

w™Ô¶U!

©"ªX±zj R SONY 9v •: -æ~
°]VIDEO CD°^°M¶b®æ•CEªæ~§B
'e°M -°J "æ\™ªª§,•U® B¥µ 'O fi
•H ±N®™™d•CE -

ªæ~ª° ©ò§U¶C• -§™°J

- VIDEO CD

• -°- -



§Æe µ¿WCM¶¿WH

- µin CD

• -°- -



§Æe »µ¿WH

• -¶ 12cm©M8cm®, ySÿSo°M®% Å™™
°©ÖÆ... °§¿B° 74§¿fi©M20§¿fi-§E¶P™™
• -°M®% ¶ª©ÖÆ... ° §¶ /Æt B -

9v CD™™ N® µ

ªæ~ªA•CE©ÚVIDEOCD°- «§B 1.1™™ªª
©M2.0™™ªª±zªªHÆ/æª - '™™Y ¶®, y°
©Ö°- « -

• - '™™ Ø± Í {™™ •Ø±

§£±a PBC •Ø± ¶PÆ..™™Y¶©Ö™™° 9v
™™ VIDEO CD ©M µ°÷ -
°]1.1™™ªªªª

±a PBC •Ø±™™ •CE qµæ~Å i§W™™ øÖ
VIDEO CD È™™©ÖÈ§¶° n È°M
°]2.0™™ªªªª iÿ®,¶ 9v ° ©Ö•Ø± -

•ÿø”

° ©Ö VIDEO CD	4
° ©Ö CD ð§~	6
•CEPBC•Ø†™Y ‡ `ÿ	8
•CE PBC•Ø†° ©Ö VIDEO CD°]PBC° ©Ö°^	8
PBC° ©ÖSE™k	9
•CE i¥™ ±µß%°X i¥°] i¥ jØi°^	10
ß%°X±z n™ i¥ ©CE¶±ÿ	11
¶b qµ`Á iSW,°æfiß@™`A	11
ß%°XØSew™ i¥ ©CE¶±ÿ	12
ß%°X i¥ ©CE¶±ÿSS™ ØSew¶im	12
•CEµ` Øj\$fiß%°X Y\$@ØSÆi¶im°µ` Øj\$fi° ©Ö°^	13
•H\$E¶P\$E¶° ©ÖCD	14
° ©Ö°\$æ ° ©Ö°^	14
»° ©Ö° fl w™ ¶±ÿ°¿ÀØj sµ° ©Ö°^	14
¿Hæ`ß«° ©Ö°µØ° ©Ö°^	15
s°s¶±ÿ™ ° ©Öµ[ß«°] RMS°X sß«° ©Ö°^	16
° ©Ö¶hin D ¶X-§~	17
ßQCE@%°L•Ø†	18
@æSÖ°-æfiß@°-i°w°Ø†°^	18
±q ±SÖ-i° i° ©Ö¶i° ° ©Ö°^	18
•CE±±ææfiß@	19
s±µ%°L•fl E;in]	20
°Üq	20
°ce°CE°R qæY-°§i q¶¿	20
°%°LIT	22
™N@µ	22
°G°Y E-	23
VÆ	24
° @	24
N°y	25
s °Ü°N ce	26



VIDEO CD

© Sony Electronics Inc. All rights reserved. Sony and the Sony logo are registered trademarks of Sony Electronics Inc. in the United States and other countries. Video CD is a registered trademark of Philips. All other trademarks are the property of their respective owners.

1 Setup

Connect the TV, VCR, and other components to the V500.

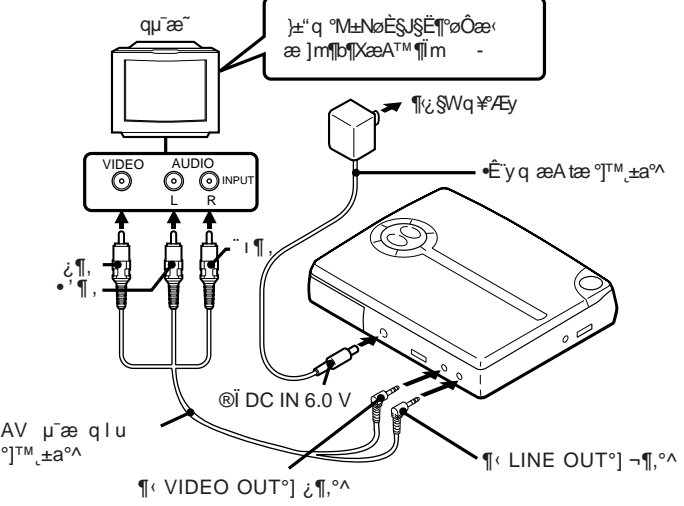

Connect the V500 to a VCR or other video source.

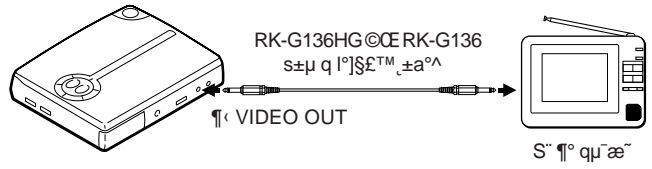

* The V500 is not compatible with certain video sources. For more information, please refer to the user manual.

2 AE/æ±z™ qm̄æ~]@w±m¶,®Ó¶°

q±°M±N±m¶,®Ó¶°) ^Æ...m@Ù°ß AUTO°@¶¶m -
¶¶p™G±X {D±z™±m¶,µe±°M-±N@%o]m@¶ NTSC@CEPAL¶¶m\$W°M o±N°X (°o
±°±m¶,µe ±-

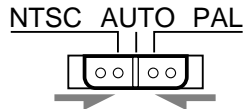

3 @Ò\$JVIDEOCD

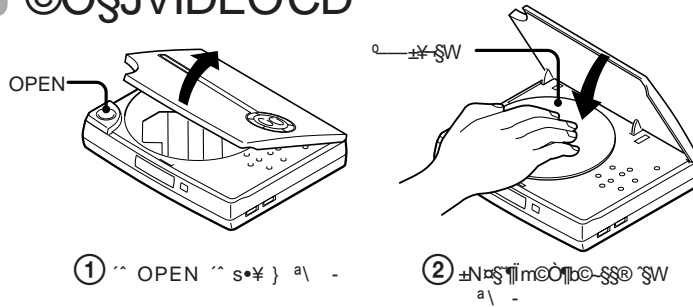

- ① ^ OPEN ^ s°¥ } a\ -
- ② ±N±¶¶m@Ù°@-SS@ \$W a\ -

4 @Ò

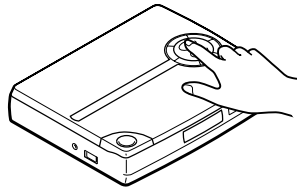

•CE PBC •Ø±° @Ò -§~ -@£ f 8 -

- ① ^ ^ i%o-
-§~)@° @Ò -
- ② •CE±±æ 'æ,°@Ò µq -]§£Ø±@ce•CE
•æ° µ q±± s ' qm̄æ~ µ q°^ -

Yn	^^
°» ±	PAUSE ■■■i%o°]@CE±±æ \$W™ ■■■i%o°^
°» ±.ï °@Ò	▶i%o°]@CE¶A ^§@ \$U PAUSE ■■■i%o°^

^ POWER OFF ■]@CE±±æ \$W™ ■°^
¶o±\$O°@
•æ¶PAE... ^ q -

s±µ@%°L¶¶i jn]

¶¶p™G±z±N±æ° s±µ@%°L¶¶i jn] °M±HTMY ±@ßÚ¶¶m jn µAEf™G -±° -@£ß s±µ@%°L¶¶i
Èjn] °@°] f 20 °^ -

° ©ÒCD ¤§~

1 s±μ

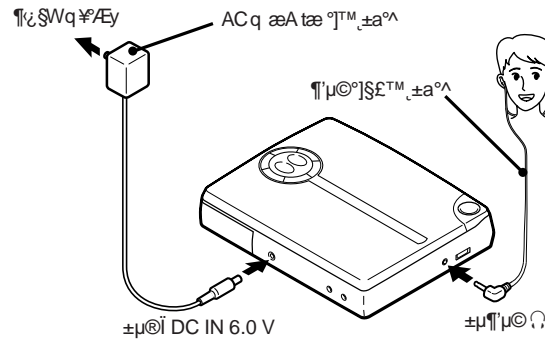

2 ©Ò§JCD ¤§~

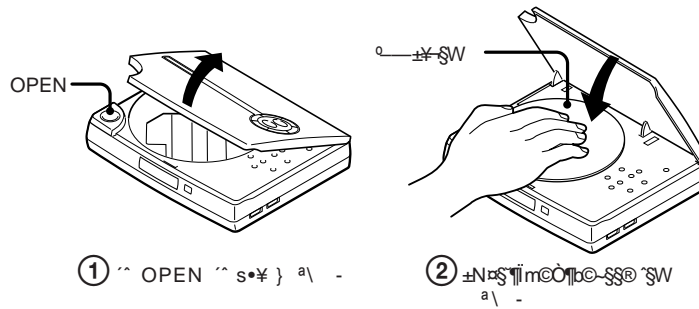

3

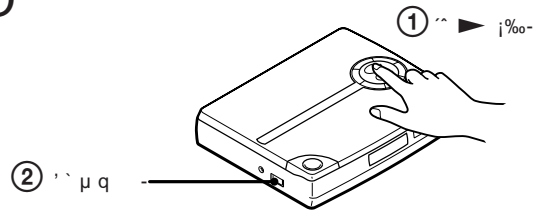

Y n ±\$Ó° ©Ò°M™ POWEROFF ■]©CE
 aa±±æ \$W™ ■°Λi%°-
 °æ°¶PAE... ^™ q -

Yn	^^
°» ±	PAUSE ■i%°]©CE aa±±æ \$W™ ■i%°°Λ
°» ±·.í °©Ò	▶i%°]©CE¶A™\$@ \$U PAUSE ■i%°°Λ

®· -\$~
 ^^\$US\$-I@°·X -\$~

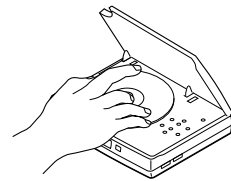

- ©Ú„°\$β™ N@ μ
- í±z¶b RESUME Q]™ OFF™™™ A\$U™\$F
 ▶i%°M'h™ -\$SW™ i¶±y°°y©Mi™™°
 ©ÒÆ... °±N„°©„í¶i -
 - ¶b°©ÒÆ...M„°X¶±y ©Mi¶±y™\$w°
 ©ÒÆ...°-
 - °» ±Æ...M\$w°©ÒÆ...°X{{{ -
 - ¶b@, ¶±y\$β °Æ...M„°X\$US@ ¶±y™™ }
 ©/Æ...°-

¶b±±æ \$S À q¶i¿
 Ó « q¶i¿™ +©M-°M Á\$J@, R6
 °JAA WÆE°^ q¶i¿ -

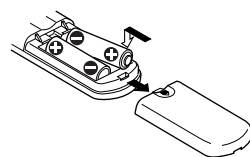

- ©Ú-\$β™ N@ μ
- -™NO~-\$M°M@-\$Æ...°ESÆ@%°°
 t -\$£ nf \$CE -\$™i ± -
 - \$£ n¶b -\$SW KØ°©M ¶±a -
 - \$£ n™-\$@, β™Æg©E±μ™Ô° q fi Dμ•
 ° -\$£ n±N-\$Ø©¶b β™Æg™ ±ææ@Æ-
 \$ \$ -

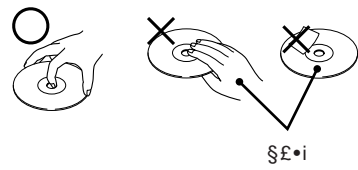

\$£·i

▶▶CEPBC•\Ø†™Y †`ÿ

•CE PBC •\Ø†° ©Ö VIDEO
CD°]PBC ° ©Ö^

βQ•CEPBC•\Ø†°M±z•i° ©Ö®,] PBC
•\Ø†™ VIDEO CD°]2.0™©°^]±z•i°H™
•CE jØ•\Ø†°™Y †•É\$™ n È °^
—•Ü®œ•CEŠ™k•iØ†•H—\$™\$£P™
β°M]™] ±z•i°H —æ\•H—\$™,±a™ a°
Æ—

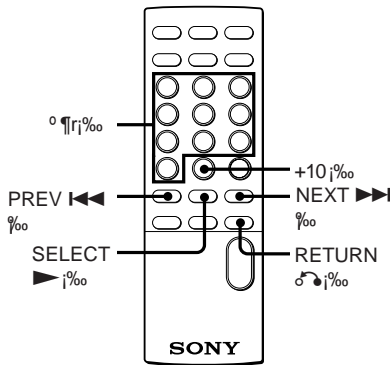

- 1 ©Ö\$J®,] PBC•\Ø†™ VIDEOCD°] —
②£ f 5 °^ -
- 2 ^^ SELECT ▶ i%°M)©] PBC ° ©Ö -
øÖ È•X {]b qm~Á i\$W °M°RSELECT°
]r°Á]b•aæ™ „•Á\$W { { -



3 °]r%øÖæ±zQn°©Ö™øÖÈ\$W™
µ•ÿ -

Y nøÖæ: µ•ÿ°]r 3°M'h—^ 3-
Y©°øÖ™ µ•ÿ°]r W L 11°M\$œ ^
+10i%°MµM'•]A™™±z™ °]r%øÖÈ\$J
"]i°]r -
@°J
^ 12°J+10°M]A ^ 2-
^ 24°J+10°M+10°M]A ^ 4-
^ 30°J+10°M+10°M]A ^ 10-

•æ\$Wæfß@

^^ MENU +/- i%øÖæ: µ•ÿ° MµM'•]A
^^ ▶ i%°-

4 ÆæøÖ È\$W™,•i™',•O' \$W z L
µ { -

i	^^
QnøÖæ:µÿ	^^aa±±æ \$W±z©' Q n™ °]r%° -
	^^aaæ~\$W™ MENU +/-i%øÖæ:µÿ °M µM'•^^ ▶ i%°-
i°©ÖB µe± Æ...RSELECT°]r °Á]b qm~æ~Á i\$W { {	^^]r%° ©Ö B µe ±Æ...M°]r%°©Ö MENU +/- ©M▶ i%° £•i°H i\$J\$U\$@ " i ¥ -
Qn]r°e±™øÖ Èµe±	^^ RETURN ° i%°-°]£P° -°M i°æfß@•iØ†]° Æt β - -æi° - ©™™ ±a™ a°Æ—°

n°H# qSÈ¶°©Ò°-°M'h-@'Æ±a
PBC*Ø±™°©ÒSÈ¶°
°aa±±æ SW™ PBCON/OFF¶%°M°æ±±
qm̄æ~SW',°°X°ß PBC OFF°@°MPBC',°
øO¶b'Á iSW/Æ°c°M°)@# q°©Ò°¶H¶±
°y X ß«°^ -¶Æ...°M\$£Ø±°©Ò°¶AøËÉ
¶b\$™ ÿRµe-Y n¶±a PBC*Ø±™°©Ò
SÈ¶°M¶A''¶%° -

PBC°©ÒSÈ¶™k
SU±°OS@°" PBC°©Ò™@°S°M°-©Û
@ce°CESÈ¶™k°Ø±H-S™ SÈ¶¶P¶°ß°M¶¶°Á
¶i-æ°H-S™±a™æ°Æ-

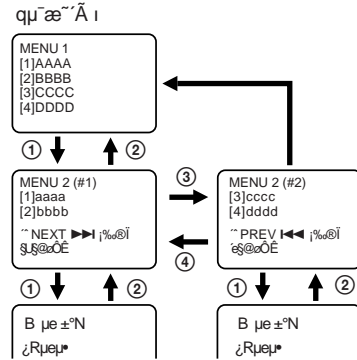

- ① ØÒæ' µy °J
°aa±±æ SW™ @°a, n™ µy °¶r¶%°M
©CE°MENU +/- ¶%øÒæ' X°MµM°°
▶ ¶%°-
- ② ¶¶'e ±™ øËÉ°J
°° RETURN ¶¶ ¶%°-
- ③ ¶¶SUS@° °øËÉ°J
°° NEXT ▶¶¶ ¶%°-
- ④ ¶¶@¶eS@° °øËÉ°J
°° PREV ¶¶¶¶ ¶%°-

•œ ì™ ±µß%œX ì
 °] ì¥ jØì°^

¶b±aPBC•Ø±™ VIDEOCD\$W°MøÖ
 Êµe ±°M B µe ±°MØM¿Rµe\$¿™°ß ì
 ¥°œœ•BœC™ ì¥ß°±a¶ ì¥ X -
 ¶b°œÖÆ...°M¿d'¿e™ ì¥°Mœ±N
 œ°œ„•¶b qµæ~Á ì\$W° —œ£ f 11
 °^ -- O¶i±z Q n°œœ™ ì¥ -

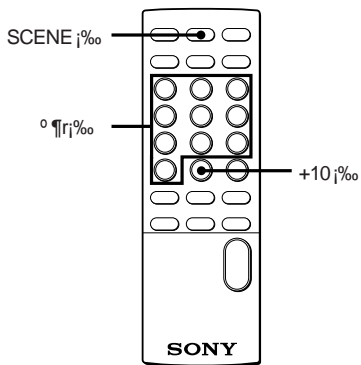

1 °œœ—\$Æ...^ SCENE ì°œ-
 °ßSCENE°œ',•±NœX {¶b qµæ~Á ì
 \$W-

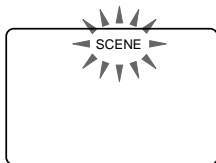

2 ~°¶rì%œM +10%°MøÖæ±zœ' Q n™
 ì¥ -
 œ'øÖæì™ ì¥ •X {¶b qµæ~Á ì
 \$W-



nøÖWL 11™ ì¥°M\$œ ~ +10
 ì°œ°MµM'•~µ¿™°¶rì%œœÊ\$J™¶i™
 °¶r -
 œ°J
 n ì¥ 12°J+10°M¶A^^ 2-
 n ì¥ 24°J+10°M+10°M¶A^^ 4-
 n ì¥ 30°J+10°M+10°M¶A^^ 10-

Y±z•X\$Fø~

±q f\$@œB)œì' ¶P°Á™ Lµ(-

™°J

- °Yœ«—\$µL™k±q°Y\$@Ø\$œw™ ì¥)œ°œÖ -
 ¶b™G±z¶b°œÖœ—\$§§°MøÖæì\$F\$@™ ì¥
 °Mœ'øÖæì™ ì¥ ±N ì±q qµ~Á ì\$WÆ
- œ°M°œ~hf~fÙ°œÖ ì'e ì¥ -
- °Yœ«—\$§£Ø±¶b qµæ~Á ì\$W„•œ'øÖæì™
 ì¥ -

► Ɔ%oX±z n™ ƆCE¶±y

¶b qm~ Ɔ ƆSW „æfiß@™™ A

±z•H¶b qm~æ~ Ɔ ƆSW d~)•æ™™ §u
ß@™™ A ƆM¶ ˆ±™™ §@ ƆT -

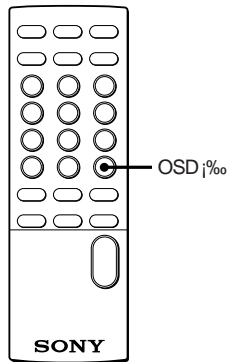

ˆˆ OSD Ɔ%o-
ƆC Ɔz~§@§U „%oM OSD¶ Ɔ ƆSW „
•ˆ^§Ɔ¶¶p§U Ɔ§ °J



ƆOæ¶ß OSD1 ƆAE...MY~ ƆƆU Ɔ%oM
æfiß@™™ A h |•X (ƆX) f j - Ɔ§@§Ɔ ±°M i
øOæ¶ßF ƆBOSD2 ƆAE... ƆM§U¶C ƆT h |•X {
¶b „, ƆSW -

■ ¶b° ƆO§Ɔ±a PBC•VØ±™™ VIDEO CD
ƆCE ^ PBC•VØ±° ƆOAE...

° ƆO™™ A¶ ƆO§Ɔ•X (¶B ► ƆM°) ±
AE...•X (¶B ¶¶ ƆMß ÷ iAE...•X (¶B ► ƆM
ß ÷ AE...•X (¶B ◀ ƆM°) X {

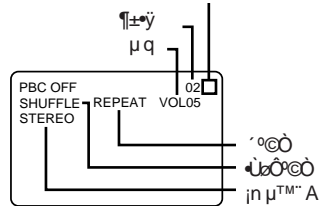

■ ¶b° ƆO±a PBC•VØ±™™ VIDEO CD AE...

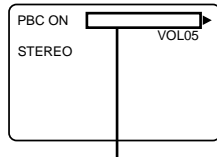

ƆCEμ~ ƆWØ Ɔj§fi -

n ƆÄ d±z•¶b~)™™ Ɔ™™ XAE...

¶bˆˆ OSD øOæ¶ß OSD 2° Ɔ°Mˆˆ
SCENE Ɔ%o-

n ƆÄ d±z•¶b~)™™ Ɔμ~ Ø Ɔj§fi AE...

¶bˆˆ OSD øOæ¶ß OSD 2° Ɔ°Mˆˆ V-
INDEX Ɔ%o-

■ ¶b° ƆO μjn CD AE...

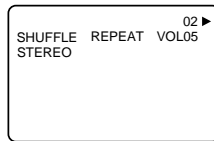

™™ °J

- Ɔ±z¶b Ɔ%oLø væ§Wø s•æ™™ ° ƆOμe
AE...M - T¶(øOæ¶ßF°ß OSD OFF°-ß h°M
„•(™™ § AE§)±N Qø°s¶b "ø væ§W -
- ¶b° ƆO μjn CD E...Y Q „æfiß@™™ A°M ••
¶b±μ q q 'e s±μ AV μæ q l -
- Ɔ±zˆˆ POWER OFF [] ƆCE±±æ §W™™ ■^
Ɔ%oˆˆæ AE...M OSD °¶±N OØd§Ɔ Ɔ-¶p
™™ ƆƆ§U E y q æAæ ƆCE§UR q¶æY-
§! q¶ Ɔ°M OSD °¶±N | Q Ɔ° AE°] °ß OSD
OFF ° Ɔ°^.

3% X ØSOW™ Æ@CE¶±•ÿ

3Q•CEPREV¶¶/NEXT¶¶¶¶¶¶¶¶¶¶AMS
 °J¶¶ ¶÷ P¿ °^@CE° ¶¶¶°°M±z•i•H¶¶b –
 §°°Ö§§'ß±¶¶aß°°X•U§@ Æ@M¶¶±•ÿ -

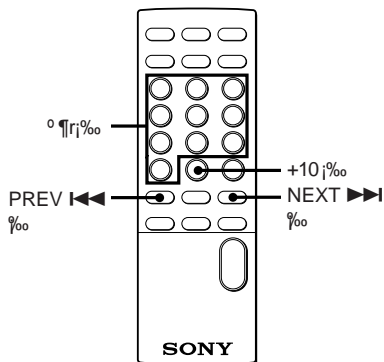

nß°°X	^
§U§@'@CE°°°™ iæ@M¶¶±•ÿ °]AMS°^	§œ ^^ NEXT¶¶¶ ¶°°™¶¶¶°°¶¶° ¶¶±•ÿ
Ïe@CE'e±™ ¥ °]AMS°^	§œ ^^ PREV¶¶¶ ¶°°™¶¶¶°°¶¶° ¶¶±•ÿ
™±µ'@W™¶¶±•ÿ	¶¶±•ÿ™ ° ¶¶¶°

Ï±zQ™±µß°°X XWL1™¶¶±•ÿ
 §œ ^^ +10¶¶°°MµM'•È§J°¿™ ¶¶¶
 ° ¶¶¶ -
 @°°J
 n 12°J+10°M¶¶A^^ 2-
 n 24°J+10°M+10°M¶¶A^^ 4-
 n 30°J+10°M+10°M¶¶A^^ 10-

™°°J
 ¶¶b°@Ö±a PBC •\Ø±™ VIDEO CD
 ÆE...M°@¶¶°ß@™ PBC¶¶ß@¶¶°@œCE-

3% X Æ@CE¶±•ÿSS™ ØSOW¶¶¶
m

±ziÿ•i•H¶¶b°@Ö-§°Æ...ß°°X Æ@CE¶±•ÿ
 °ÿSS™ ØSOW¶¶¶i m -

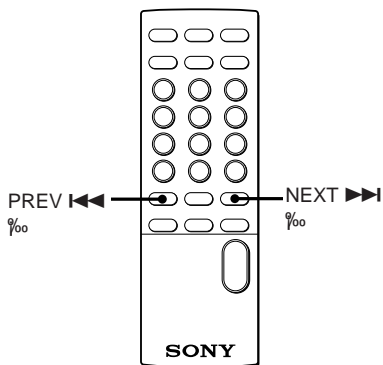

±µ§U →

nB%XS@¶¶m	^
¶¶b [¶]µe ©CE •µTÆ...	PREV ◀◀©CENEXT ▶▶i%© ^zÆ¶¶i™@i B%©¶¶¶m°¶¶b°© VIDEOCDÆ...°Mjn µ ¶¶A•Ö\$Æ©CE°~

- TM°J
- ¶¶PBC°©ÖÆ...°M¶¶•Ø± »¶¶b°©Ö B µe ±
Æ..¶¶Æf -
 - °©Ö VIDEOCDÆ...°M¶¶b jØi™" Aµe •Ø±
|Æ•Ö•øØu -
- CEµ- Øj\$fiB%°XY\$@ØSÆ¶¶i m°¶µ-
Øj\$fi°©Ö°^
- CEø°as™µ- Øj\$fi°©Ö VIDEO CD
Æ...°M±z°i+¶¶b°¶¶P™¶¶±y\$S\$B%°X±z Qn™
¶¶Y\$@ØSÆ¶¶i m -

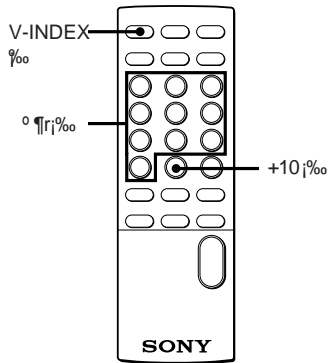

nB%XS@¶¶m	^
i°©Ö\$@¶¶±y Æ..¶¶M±µÖæ'	1 ^ V-INDE X i%°- 2 ¶¶A °¶¶r%°øÖæµ- µ- Øj\$fi - Øj\$fi X -

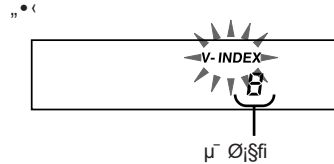

qmæ°Ä i
¶¶b°BOSD2°@SÈ¶¶°Æ...°^

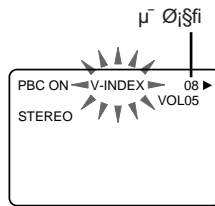

- i™±µB%µ- Øj\$fi \$@Ö11™¶¶i m
- \$œ ° +10i%°MµM°-øÈ\$J±z™ ¶¶i
 - ° ¶¶r -
 - @°°J
 - nB%° 12°J+10°M¶¶A ° 2-
 - nB%° 24°J+10°M+10°M¶¶A ° 4-
 - nB%° 30°J+10°M+10°M¶¶A ° 10-

Yn±\$ÖµzWØj\$fi°©
¶¶A¶¶ °zÆ V-INDE X i%°-

- TM°J
- ¶¶b@S¶¶µ- Øj\$fi™ VIDEOCD\$WµL™k©æ°CE
µ- Øj\$fi°©Ö -
 - ±zµL™k¶¶b\$E¶¶P™¶¶±y\$S\$B%µ- Øj\$fi -

1. Press the **PLAY** MODE button (marked with a right-pointing triangle) to enter the INTRO PGM mode.

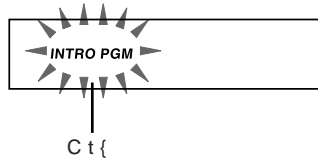

2. Press the **SELECT** button (marked with a right-pointing triangle) to enter the INTRO PGM mode.

3. Press the **REPEAT/ENTER** button (marked with a right-pointing triangle) to enter the INTRO PGM mode.

Press the **PLAY** MODE button (marked with a right-pointing triangle) to enter the INTRO PGM mode.

- TM:J*
- Press the **REPEAT/ENTER** button (marked with a right-pointing triangle) to enter the INTRO PGM mode.
 - Press the **PREV** button (marked with a left-pointing triangle) to enter the INTRO PGM mode.

How to Use the INTRO PGM Mode

Press the **PLAY** MODE button (marked with a right-pointing triangle) to enter the INTRO PGM mode.

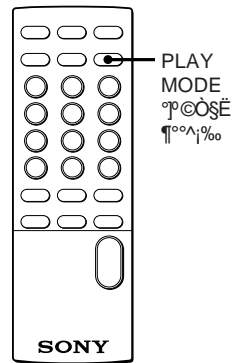

Press the **PLAY** MODE button (marked with a right-pointing triangle) to enter the INTRO PGM mode.

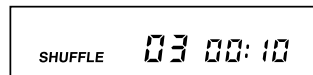

Press the **PLAY** MODE button (marked with a right-pointing triangle) to enter the INTRO PGM mode.

- TM:J*
- Press the **PLAY** MODE button (marked with a right-pointing triangle) to enter the INTRO PGM mode.
 - Press the **PREV** button (marked with a left-pointing triangle) to enter the INTRO PGM mode.
 - Press the **REPEAT/ENTER** button (marked with a right-pointing triangle) to enter the INTRO PGM mode.
 - Press the **PBC OFF** button (marked with a right-pointing triangle) to enter the INTRO PGM mode.

ΣΔΣΑΨV™ 0 00μ{β«
 0J RMS * X sβ« 0 00^Λ

±z*H^± -S~SW¶±y™ 0 00 β«, @
 s^s¶±V™ 0 00μ{β« - μ{β«SS Å¶h•iβt 22
 "¶±y -
 * RMS 0zHæ~ μ^ Pz æ™ iy^g -

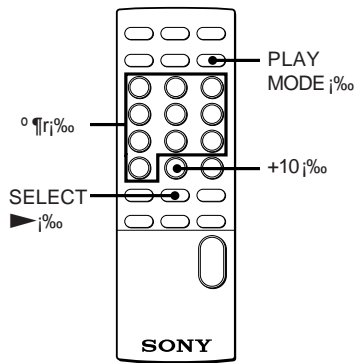

1 0 00^E... ^ ^ PLAYMODEiy™ 0i
 0BRMS 0 { { -

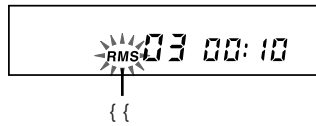

2 ~o ¶r%αCM +10%0M0æ±z Q s^s^
 00μ{β«™ ¶±y-
 ¶±y CM@%0 0 β«X { -

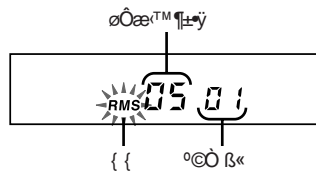

n0æ' sJ@U11™ ¶±y Sæ ^ +10
 iy°MμM'0E SJ^z™ ¶¶r -
 @^J
 nβ% 12°J+10°M¶A^ 2-
 nβ% 24°J+10°M+10°M¶A^ 4-
 nβ% 30°J+10°M+10°M¶A^ 10-

3 ' f 2@B°M s± ¶n±z fl w™ ¶±y -

4 ^SELECT ▶ iy°M°BRMS 0 ±SÓ {
 {°M^ ^z@' sβ«00æ™ ¶±y β« }
 0° 00 -

Y n ±SÓ sβ« 0 00°M ^ ^ PLAY
 MODEiy™ 0iβ RMS 0^E•ϕ-

^d^¶±y β«
 ¶b i¶É f 4 @Bβ' e°M^ REPEAT/
 ENTER%°M±zC^S@¶ ^°M@Åsq{ β«
 „¶±y - „β sβ«SS™ Å'S@ ^¶±
 y ^°M" sβ«SS™ fS@ ^¶±y 's„
 • < -

^d^00æ¶±y™ iy°CMiy° 00^E... °
 ¶b i¶É f 4 @Bβ' e°M^ REPEAT/
 ENTER%S@i^H\$W^Miy°E...M¶±
 y™ iy°CMiy° 00^E... °X ¶b „Å\$W -

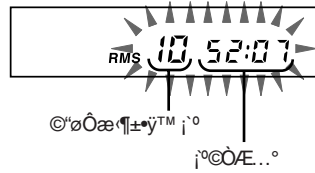

TM 0 J

- Y±z@“ sß«™ ¶±•ÿ° ¶h@Ú 22 °°M'h f\$@ ”
©'ðÔ™ ¶±•ÿ±N Q· ±©'ðÔ™ ¶±•ÿ•N¥¿ -
- Y „••X°ß - - : - - ©¥¿•Nj'° ©ÔÆ... °°M'h
.. °J
- ±zðÔæ:™ ¶±•ÿ° §j@Ú 31 ” -
- j'° ©ÔÆ... °§j@Ú 100 §¿fj-
- ¶p™G °° ¶r%°] —æ\ 12 °ATM ±µðÔæ:§@
¶±•ÿ°M±N |@'Æ' sß«° ©Ô -
- ¶bPBC ° ©ÔÆ... °M¶ •\Ø±µLÆf -°] n] m
PBC OFF °M —æ\ f 9 °^ -
- ±z\$EØ±@œ°CEµ ¿WØj\$fr@° ¶È sß« -

° ©Ô¶hjn D ¶X-§~

¶hjn D ¶X-§~§§°°§§F\$E~¶¶P™ °™
•kjin D µ T -±z•i•HøÔæ°™in D©CE™Ä•kjin
D°M, ©'ðÔæ:jin D™ µ T -oÆ...±N•ø•h
¶fl ÈjnÆf™G -

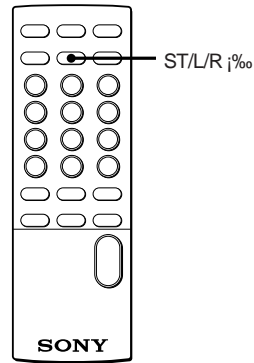

¶©Ô¶hjn D ¶X-§~Æ...°M^ ST/L/R
j %° -
©C ì±z~§@§U °i%°M', •\$Æe©M±z •
©j™ jin T±N¶p\$U ¿\$ °J

^	„ • < *	±z • ©j™
§@¶	L	•™in D µ T
©¶	R	•kjin D µ T
§T¶	STEREO	•fl Èjn

* ìøÔæ°ß OSD 1°©©CE°ß OSD 2°©¶] §J OSD
°¶Æ...

RESUME % OFF

RESUME % OFF - æfiß @ " i w 0 1
 ± z i H CE HOLD } ^ i i % L æ fiß @
 l ± z j H @ ± æ æ / E ... O S Q S j K B Q T M -

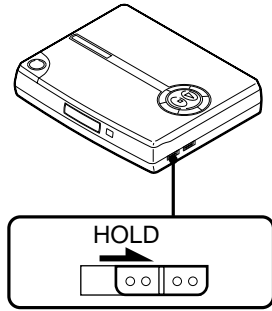

^ b j Y S E i V j k ^ ± z æ HOLD } ^ -
 æ æ S W T M i % S E _ B @ CE -
 µ M i i M i H HOLD 0 1 _ B @ CE E ... M ± z S j
 i H CE æ æ æ æ fiß @ æ æ -
 Y n @ ce CE æ æ S W T M i % M ± N HOLD } ^
 æ i i c i s ce S E i V j T M ^ -

± q ± S 0 - i i ° @ 0 j i ° @ 0 ^
 i b q ± ° T M p S U M B C i ± S 0 ° @ 0 : M i A
 i ° @ 0 j i ° O ± q - S T M _ @ i B) @ i - i ° O M
 i ° @ 0 j i ° 0 1 0 1 ± z ± q A T M O ± ° T M @ S @ i i
 m B) @ i , • -

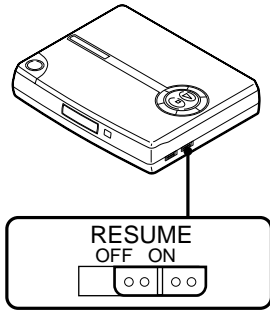

] m RESUME ° ON -
 Y n @ æ / E i i ° @ 0 j i ° M ± N
 RESUME] m ° OFF -
 T M ° j
 • i ± z æ } æ / E ... M @ S] m RESUME } ° M
 h ± N C æ - T M i i m æ æ h - S U i ° @ 0 E ... M
 ± N ± q _ @ i B) @ i ° @ 0 -
 • i ° @ 0 j i m e i i 0 1 æ t 30 i j i -
 • i b P B C ° @ 0 E ... M i i 0 1 µ L æ f - °] n] m
 P B C O F F ° M - æ \ f 9 ° ^ -

•CEAAHæafB@

μ q
 ±z•i•H•CEAAHæ μ qμæ μ q@M¶
 μ@ μ q¶¶b 01-10 TM d US °^ -

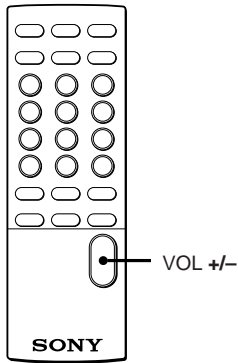

^^ VOL +/- i%-
 î±z VOL +°M μ q°W•[°M î±z
 VOL -°M μ q#Ó\$P -

TM°J

- ^ "•aæ q ' . 10 \$ifj\$ °M•i•H'^aa±±æ
 \$W™ SELECT▶i%o }±"•aæ~·¶p™G\$w W L
- 10 \$ifj°M -'^•aæ~\$W™ ▶ i%o±N•¶ }±"-
- \$E n±N±æ™ Ô B•@CEμo• Å m -
- æ)±æ « Pæ@M±æ \$B °TM aY TMTM' -

±µ®%•L•fl Èjn]

±z•H q L®%•L•fl Èjn] °©Ò –
 §°M©CE™Ä±N –§°s¶b ce±a©CE°v±a§W-
 '±° –æ\®%•L•fl Èjn] ™®CE°
 AE –
 ¶b s±µ•H'e°M±N©CS@ °fl Èjn] B°
 ^ ± ° -

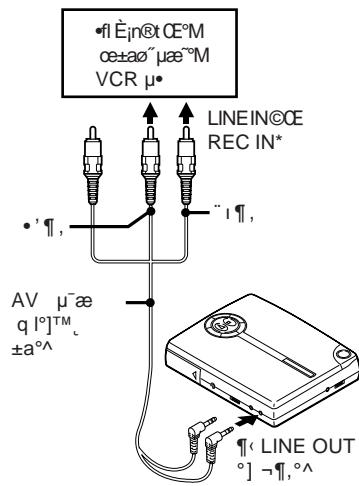

* Y®%•L•fl Èjn] °JµL LINE IN ¥°Æy•ÁµL
 REC IN ¥°ÆyÆ...°M →CE RK-G134 s±µ q l
 ¶§Æ™ ±a°±N®% s±µ®¶ MIC ¥°Æy§W-

- ™°J
- ¶°©Ò VIDEOCD/Æ...°M±Nµ¿W s±µ q ±µ
 ®¶ VIDEO OUT ¥°Æy§W-
 - °©Ò –§°H'e°M±N©° s±µ] ™ µ q °sp°M
 •HßK l a¥ jnæ -

►°Úq

®ce•CE•i•R qæY~°§l q¶¿

¶b f§@¶®ce•CE•i•R qæY~°§l q¶¿H'e
 ±N®%•R q-

1 •¥ } q¶¿øµ a\ -

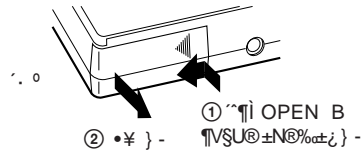

2 ¶p ce°¥§U•i•R qæY~°§l q¶¿™®¶®%
 Q q¶¿-íß~í¶¶°M® °§W°™°O -

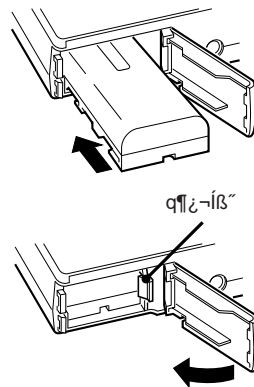

n®§U•i•R qæY~°§l q¶¿

•¥ } a°M° b¿Y§Æ¶V°¿£ q¶¿-íß~

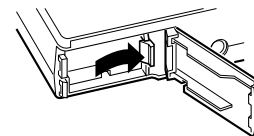

3 s±µ¶¶n AC q æA tæ ©•R q~ 8Şp
 AE...
 „••X°ß CHG°@@ 'O~@j•R qµ ßÙ -

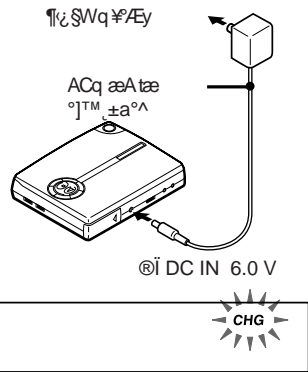

4 i•R@ q:°M@fiŞU AC q æA tæ -

¶qE...
 İ q¶İ•CEß '•M'Á İŞW „••X
 °ß↻°@-
 µ•i•R q q¶İ•R q -

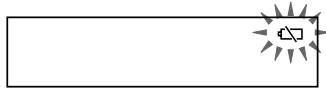

q¶İ•y©R
 İ±z¶¶b• TM ¶aŞE©ce•CE°aæ~ -
 ¶ŞpAE...°^

ç'™	CD	VIDEO CD
q¶İ•y©R	™ 12.0	™ 4.0

TM¶G

- °©Ö µ¶n CD°M¶¶µ¿W s±µ q tæµ©İ VIDEO OUT¶¶ÆyAE...°M q¶İ•y©RiYµµ -¶¶±µ q q °©Ö µ¶n CD/AE...°M -±Nµ¿W s±µ q tæq VIDEO OUTÆyŞW©fi±°
- R q/E... °µ•R q q¶İ•y©R°ce•CE±°TM¶¶¶¶ ¶Ş -
- Y q¶İ•y©R°s°TM©CE°TMÆ...°°°CE°M¶¶±z•R q'æ¶¶ ¶İz±@Sß••R q'¶M -±N@%©Ö¶X¶¶ q -

▶%LÍT

TMN@μ

¶W.

- ²æ §\$@*CE™ p/Æg' Ô ¥ '¶Æ' --§
©O@²æ-
- -§ ±N ß™' Í\$J DC IN 6.0 V ¥°Æy'~
° q øÈ\$J°^ -
- YU¶ÚOT ACCEGATM' È±\$J²æ~M@f\$U
¥¿Y°M¶b\$@U¶Ú@ceCE+H°È±M-§H\$B
Z -

q

- |±z'± |\$@'qAE... °\$§È@ce²æ~M±q²æ
æ~\$W-_)@¶¶ q -
- TM|°\$u\$@ q¿È°M°Ø"μ°TM °-μP K¶¶b©
° -

ACq æA tæ

- u@ce²æ™ ±a™ACq æA tæ -§È n@ce
• CE+U¶Ú@%LACq æA tæ -

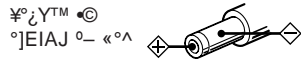

- Y±q¿Æy\$W@f\$U ACq æA tæ °M-Æ
¶¶@%²æ° °M\$È n©' q | u -

•R q q¶¿

- §È n±N q¶¿ •\$J\$§\$ -
- §È n±N R q q¶¿ ©M¶uWÚ@CE@%L™f,™f,™f
È©O¶b\$@_¶MY q¶¿™f,™f ©Mt°μM
©M™f,™f È±μf °M±Ø± |μo° -

•²æ~

- ²æ~\$™ z È-'O~°%¿R°M\$È n°CES,f
N-ß_h È¿Y°iØ± | a°M²æ±N\$ÈØ±°ø
±`\$u\$@-
- §È n±N™ ©O¶b²æ~ a °M o |@ce²æ~
©M -§æD | a -
- §È n±N²æ~©O¶b±™Ø° °MCEß°™
Æg°M-§g L¶h°MPE¿,°M@_B O°M¶¶æ±Ø
Æ °M... ±™±μ¶¶a\$È°MCE™A©O¶b@Æf
Ú °™ @Æ\$ -
- ¶p™G²æ~ Ø¶¶ μæ~©CE qμæ~\$fi_ \$z-Z™
-±N²æ~ ±°' a -¶¶¶ μæ~©CE qμæ~ -
- @ce²æ... °M\$È n°CE@Y°©CE±\$¿ø²æ~M
o |\$fi_²æ~\$u\$@ \$È±°©CEμo°OfY °G
a Y -

@ce¶¶@Æ..

¶È Ú¶¶

- ¶b@ÆM M@Æ©CEææææ@ÆÆ...-§@ce
• CE¶¶μ©- o |\$fi_ È q@ °G°M¶b°Y@«¶¶a\$È
o°O H™k™ ¶È ÚÆ...°H™ μ q, ¶¶μ@§
¶°Á¶b¶M¿¶M\$@%°O¶b¶È\$Hæ±¿™¶¶a\$È -
¶b@,¶¶¶M¿©™¶¶a\$È±z¿ °O~™¶' f μ±ß©CE
§È sfÚ@ce²æ¶¶μ© -

@æ\$O°\$O@,Á

- §È n±H™ μ q@ce²æ¶¶μ© - °\$O±MÆaf\$
¶¶\$È n sfÚ°N™ μ q@M™Æ... °ce²æ¶¶μ© -
¶¶™G±z P@¶¶°M-¥ØßC μ q@CE° ±@ce
• CE -

TMNL\$H

- ±N μ q@O¶b\$§μμ(°M o |@ce±z °@
• °™ in μ@ °U@±z@P Ú™ @%L\$H -

GaY E

¶pTMGzzz@SF\$U¶CzÀ'd:~¶¶G^Y¶s¶b
 -¶N™OEM SonyæP, "ip@t -

- S~\$EØ±° ©OCEæ~SSj~µM¶¶ -S~¶¶
- Á 1, °ß na di 5L°@-
- -S~aj ¶@CE¶¶ SÚØf -
- Á-S~Æ...±N°-±±¥-SW -
- £-ØSFz,ÆææÆÆ -
- ±N°æ~±¥XSpÆ...™@¿,ÆÆÆ £ -
- ÊzYaj ¶¶ -
- ±N°æ~™ a\$@M q¶¿øµ^fY±K -
- -T^("OB_ø T¶¶a ASJSF•R q q
- ¶¶¿ -
- ±NAC q æA tæ Ú Ú¶¶a¥°Sj¿
- Æey-

µLjn@CEØ±°@æ µ -
 → ¥°¿Y s±µ\$£ Ú±K -
 → ¥°¿Yaj ¶¶ -•OET™Q n™ @Y°~±N¥°¿Y¿ø

in µ, ±øµL¶¶l ÊjnÆf™G@¶¶@: Êjn D -
 → ¶¶æ±±æ SW™ ST/LR;¥°™ @ijn

ì±z~;¥°Æ...°M'Á i\$W, °ß Hal d°@
 → i¥°æfif@ Q @O ±N HOLD }¶¶V•™

- qm~Á i\$WµLµe ± -
- T^¿ qm~æ~\$w }±" -
- T^¿ qm~æ~\$W±zøOæ\$Fø T™ µ¿¿W
- øÊ\$J-
- ø T¶¶a s±µµ¿¿W s±µ q l -
- °@O™ °O µjn CD \$~
- ¶¶b°@O µjn CDÆ...\$w s±µ\$F AV
- µæ q l -¶¶b±µ q q 'e s±µ" q
- l -
- ±N°æ~™ a\$@M q¶¿øµ^fY±K -
- T^¿ -S~\$W¶¶ •H\$U°-O -



- ±z¶¶µL™k°@OY@«DTMk a\$™ -
- S~°j;µM•¶¶ Á\$¶¶L¶¶ \$W z°- O°^ -
- J¶¶ ±°™p°M -aP" -S~™ æP, "ip
- 'Y -

µe B.¶¶± -
 → i°»±@CEjØjÆ...µe B;¶¶±°M o@ D

æ±±æ SF\$U@
 → ^~°æ~ q ~.sj~ 10 \$¿¿f;S °M•i
 •H~aa±±æ SW™ SELECT ▶;¥°} ±~°æ~¶¶p™G\$W L 10\$¿¿f;°M -~
 °æ~SW™ ▶;¥°±N•¶¶ }±" -
 → æjæ±±æ « Pæ@Mæ±±æ \$B °™
 aY TMTM' -
 → iæ±±æ SS™ q¶¿¿\$E@Æ...°M±N@¶¶
 ™ q¶¿¿ £¥¶¶@ s™ -

VAE

QCE

S^o fl^o p/Eg^o fl^o r μjn^o μ^o @t CE
 p/Eg fi^o S^o
 B^o AE^o °J GaAlAs
 TM^o i^o TM^o °J λ=780 nm
 μ^o p/Eg AE^o .. °J s^o f^o U^o
 p/Eg θ^o E^o X^o \ v^o J S p^o U^o 44.6 μW*
 * °θ^o E^o X^o » fl^o b Z E^o z^o Y^o TM^o i^o ± 200mm B^o M^o
 •— 7 mm • æ^o «^o a^o E^o • S^o ¥^o ±^o o^o-
 TM^o » θ^o S^o E^o fl^o
 Sony • E^o S^o e j^o fl^o E^o ± ¥y REED SOLOMON
 sX^o TM^o W^o θ^o μ^o fl^o S^o
 D-A - ± ¥^o
 1-bit
 qD^o
 2 qD
 z^o W^o v^o T^o z^o
 20 - 20,000 Hz ±^o 3 dB^o °J •— EIAJ CP-307
 ¥^o ±^o 0^o °^o ^
 θ^o E^o X^o °J 6.0 V θ^o E^o S^o J q^o z^o E^o °^o ^
 fl^o μ^o ©^o °J L^o °^o • fl^o E^o jn^o ¥^o °J A^o y^o °^o ^
 7 mW + 7 mW M^o 16E^o [°
 u^o U^o θ^o E^o X^o °J L^o °^o • fl^o E^o jn^o ¥^o °J A^o y^o °^o ^
 θ^o E^o X^o q^o • 0.7 Vrms °M47 kE^o [°
 ±z^o U^o θ^o E^o X^o °J L^o °^o • S^o J ©^o U^o 10kE^o [°
 μ^o °J W^o θ^o E^o X^o °J L^o °^o • ¥^o °J A^o y^o °^o ^
 θ^o E^o X^o q^o • 1Vp-p °M75E^o [°
 ±z^o U^o θ^o E^o X^o °J L^o °^o • S^o J ©^o U^o 10kE^o [°

S^o @^o d^o

q
 • Sony • i^o R^o q^o q^o fl^o z^o NP-F530°J7.2 V DC
 æY^o - °J S^o i^o q^o fl^o z^o °M 1350mAh
 • AC q^o æA^o tæ^o °J DCIN6.0V ¥^o °J A^o y^o °^o ^
 120V, 60 Hz
 220 - 230 V, 50/60 Hz
 100 - 240 V, 50/60 Hz
 °J A^o E^o /æ^o ±z^o i^o R^o °^o v^o • °J -æ^o TM^o fl^o a^o œ^o S^o E^o
 fl^o P^o M^o %^o °^o q^o n^o D^o A^o S^o fl^o P^o °^o ^
 S^o y^o S^o °J W^o /H^o /D^o °^o ^^o °J • A^o • X^o TM^o °J ©^o M^o ±^o °^o s^o °^o ^
 °^o °^o 177.0°—34.8°—145.0 mm
 °^o q^o] E^o • R^o q^o q^o fl^o z^o °^o ^
 °^o °^o 400 B^o J
 °^o °^o 510 B^o J °J • A^o æY^o - °J S^o i^o R^o q^o q^o fl^o z^o ©^o M^o -
 S^o °^o °^o ^
 S^o u^o S^o @^o °^o ^
 5φJ - 35φJ

TM^o °^o U^o

AC q^o æA^o tæ^o °J 1 °^o ^
 AV μ^o -æ^o q^o l^o 1 °^o ^
 aa±±æ 1 °^o ^

] p^o ©^o M^o W^o /æ^o E^o Y^o fl^o S^o °J M^o A^o E^o S^o S^o E^o q^o TM^o æ^o -

±z^o U^o TM^o °^o U^o

• i^o R^o q^o æY^o - °J S^o i^o q^o fl^o z^o NP-F530 TM^o °^o U^o -

±z^o TM^o æP^o , °^o °^o U^o ±^o ©^o S^o fl^o S^o W^o z^o TM^o °^o U^o - fl^o °^o ^^o TM^o °^o U^o TM^o ±^o °^o - fl^o V^o Q^o i^o TM^o æP^o , °^o °^o fl^o -

°^o @^o

M^o - E^o z^o Y^o

• CEKK-DM1 E^o z^o Y^o M^o - S^o u^o @^o , M^o - E^o z^o Y^o -

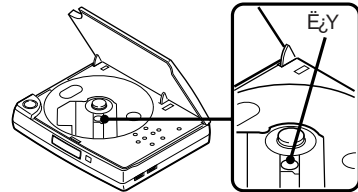

M^o - æ^o ¥^o fl^o

±^o N^o TM^o Q^o n^o TM^o ©^o Y^o • Y^o S^o W^o S^o U^o C^o E^o M^o - æ^o z^o U^o z^o °^o ^
 æ^o °^o M^o S^o E^o n^o ©^o • ©^o E^o s^o i^o M^o i^o ©^o E^o æ^o z^o -

Nay

Øj\$fi

¶b\$@`q¶±y©CE-ſ\$Wº-→X+Hß@`'©w
™ ØSAE¶¶m°MßQ•CEØj\$fiHſÉK™ß%ø±z
Q.n™'©w¶¶i m -
¶@,yØj\$fiſÉ¶°Gſ@y•CE@Úµjn CD°M
•ſ@y'h'°CE@ÚVIDEO CD-ªæ~»@œ•CE
'ſ@yØj\$fiſÉ¶°M Ýſß°ßµ- Øj\$fi°@ -

PBC°@ò

ßQ•CEøªs¶b@,PBC•Ø±™ VIDEO CD
ſW™øÒÉ¶¶É°@ò ±z•HßQ•CEPBC•Ø±
@..@,- É™•Éſ¶¶æfiß@ -

°@ò±±@ó¶PBC°^

¶bVIDEO CD°j2.0™°^ſW s X•CE@Ú
±±@ò°@ò™'H -ßQ•CEøªs¶b@,PBC•Ø±
™ VIDEO CD ſW™øÒÉ¶¶É°@ò ±z•H
°@ò@..@,- É™•Éſ¶¶°n•Ú -"n•Ú@,¶
jØjµ••Ø± -i±z¶bªæſW ÁſJ@, PBC
•Ø±™ VIDEO CD°M'Á iſW „••X
°ßPBC°@-

!¥

•CE@Úœſ¿¿Rµe°MB µe±©CEøªs¶b@,
PBC•Ø±™ VIDEO CD ſW™øÒÉ-@Cſ@
" i¥ Q .@Úſ@ " X°M Ý°ß i¥
°@ -

¶±•y

•CE+H œſ¿ VIDEO CD@CE µjn CDſW™
œ ©CE q¶± -@C'¶±•y'©wſ@ " X°M Ý
°ß¶±•y °@ -

VIDEO CD

ß¶¶ B µe ±™ S° pÆgſ° -µe °
æ•H MPEG 1°jſ@y°æ¿¿Yßfi N™ íy/
- «°N™ÆÉ¶°¿¿Y° í©°æ™ſ@ſGſQ
ſ¿ſſ@°M@øªs¶b-ſ\$W -
ſ@±i 12 cm™ -ſ°i•H £•Ö 74 ſ¿¿i
™ B µe - µjn°æſ¶¶i•H¿¿Y°M•H P
VIDEO CD ß¶¶ 6 ø@Ú µjn CD™ µjn°
æ/-

- VIDEO CD @,¶@, y™@ª -
- ™@ª1.1°JµØ±°@ò B µe ©Mjn µ -
- ™@ª2.0°JØ±°@ò¿¿Rµe©M@œ•CE PBC•
Ø±-

ს ოპერაციის ნაგებობა

სონის ვიდეოკამერის მართვის პანელი

• ნაგებობა

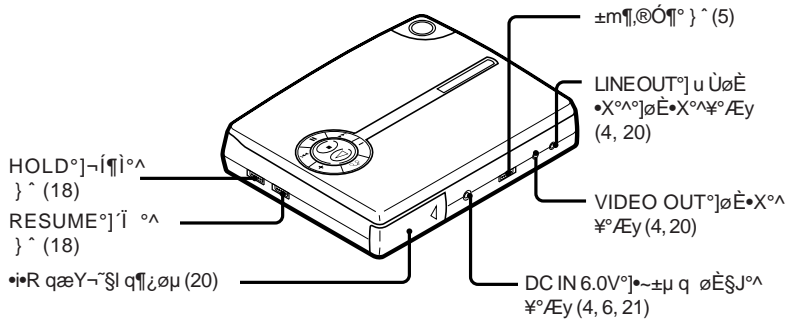
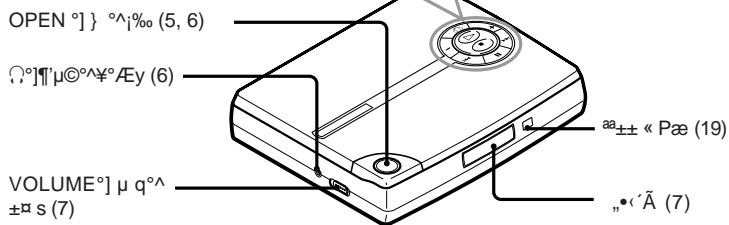
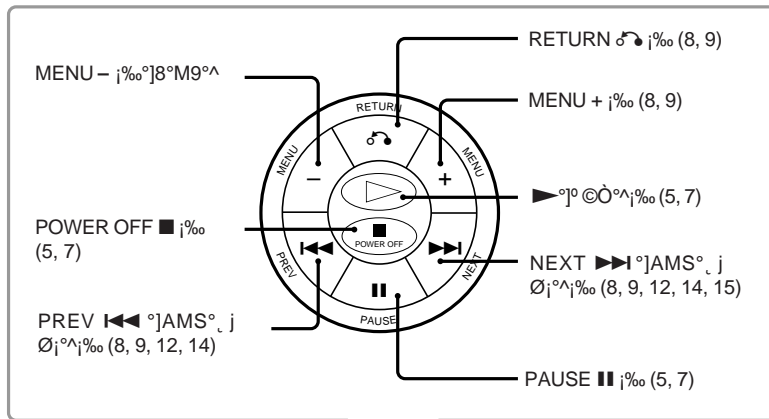

aa±±æ

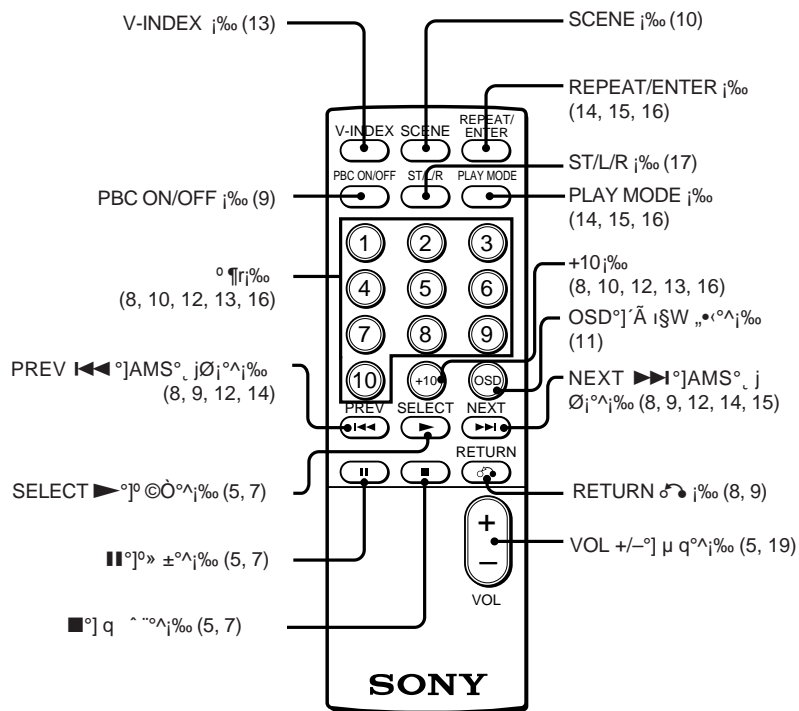

Sony Corporation Printed in Japan



Sony D-V500 (C)_3-856-309-11(1) []