

SONY[®]

3-858-651-11 (1)

Video Cassette Recorder

Operating Instructions

SLV-X717ME/PS/SG



SLV-X817ME/PS/SG



Hi-Fi

©1996 by Sony Corporation

SLV-X817/717ME/PS/SG 3-858-651-11 (1)

WARNING

To prevent fire or shock hazard, do not expose the unit to rain or moisture.

To avoid electrical shock, do not open the cabinet. Refer servicing to qualified personnel only.

The mains lead must only be changed at a qualified service shop.

Precautions

Safety

- This VCR operates on 110 – 240 V AC, 50/60 Hz. Check that the unit's operating voltage is identical with your local power supply.
- If anything falls into the cabinet, unplug the unit and have it checked by qualified personnel before operating it any further.
- The unit is not disconnected from the mains as long as it is connected to the mains, even if the unit itself has been turned off.
- Unplug the unit from the mains if you do not intend to use it for an extended period of time. To disconnect the lead, pull it out by the plug, never by the lead.

Installing

- Allow adequate air circulation to prevent internal heat buildup.
- Do not place the unit on surfaces (rugs, blankets, etc.) or near materials (curtains, draperies) that may block the ventilation slots.
- Do not install the unit near heat sources such as radiators or air ducts, or in a place subject to direct sunlight, excessive dust, mechanical vibration or shock.
- Do not install the unit in an inclined position. It is designed to be operated in a horizontal position only.
- Keep the unit and cassettes away from equipment with strong magnets, such as microwave ovens or large loudspeakers.
- Do not place heavy objects on the unit.
- If the unit is brought directly from a cold to a warm location, moisture may condense inside the VCR and cause damage to the video head and tape. When you first install the unit, or when you move it from a cold to a warm location, wait for about one hour before operating the unit.

Caution

Television programmes, films, video tapes and other materials may be copyrighted.

Unauthorized recording of such material may be contrary to the provisions of the copyright laws. Also, use of this recorder with cable television transmission may require authorization from the cable television transmitter and/or programme owner.

Compatible colour systems

This VCR is designed to record and play back using the PAL (B/G and D/K), MESECAM (B/G and D/K), and NTSC colour systems.

Recording of video sources based on other colour systems cannot be guaranteed.

Table of contents

Getting Started

- 4 Step 1: Unpacking
- 5 Step 2: Setting up the remote commander
- 6 Step 3: Connecting the VCR
- 8 Step 4: Tuning your TV to the VCR
- 10 Step 5: Selecting a language
- 11 Step 6: Setting the clock
- 13 Step 7: Tuning the VCR

Getting Started

Basic Operations

- 18 Playing a tape
- 22 Recording TV programmes
- 25 Recording TV programmes using the timer

Additional Operations

- 28 Playing/searching at various speeds
- 30 Recording TV programmes using the quick timer
- 31 Checking/changing/cancelling timer settings
- 32 Recording stereo programmes
- 33 Adjusting the picture
- 34 Changing menu options
- 35 Editing with another VCR
- 37 Audio dubbing

Additional Information

- 38 Troubleshooting
- 40 Specifications
- 41 Index to parts and controls
- Back cover
- Index

Step 1

Unpacking

Check that you have received the following items with the VCR:

- Remote commander

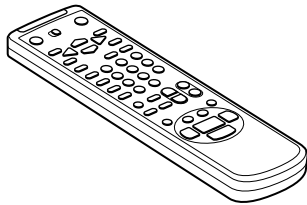

- Plug adaptor (SLV-X717ME/SG and SLV-X817ME/SG only)

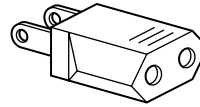

- R6 (Size AA) batteries

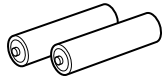

- Aerial cable

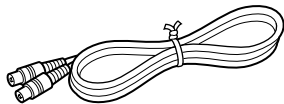

Checking your model name

The instructions in this manual are for the 6 models : SLV-X717ME, X717PS, X717SG, X817ME, X817PS, and X817SG. Check your model number by looking at the rear panel of your VCR. The SLV-X817ME is the model used for illustration purposes. Any difference in operation is clearly indicated in the text, for example, "SLV-X717ME only."

Step 2

Setting up the remote commander

Inserting the batteries

Insert two R6 (size AA) batteries by matching the + and - on the batteries to the diagram inside the battery compartment.

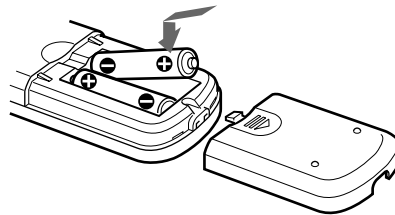

Getting Started

Using the remote commander

You can use this remote commander to operate this VCR and a Sony TV. Buttons on the remote commander marked with a dot (•) can be used to operate your Sony TV.

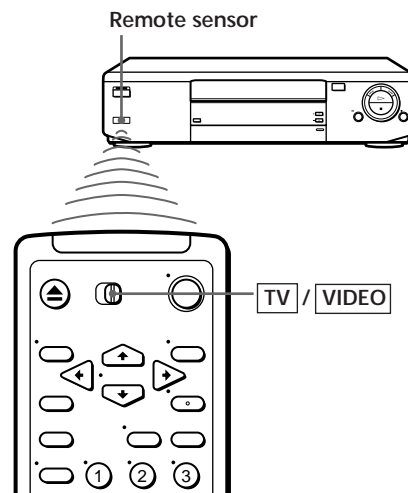

To operate	Set TV/VIDEO to
the VCR	VIDEO and point at the remote sensor on the VCR
a Sony TV	TV and point at the remote sensor on the TV

Notes

- The TV/VIDEO button selects an input source of the TV from aerial in or line in. The button does not control this VCR.
- With normal use, the batteries should last about three to six months.
- If you do not use the remote commander for an extended period of time, remove the batteries to avoid possible damage from battery leakage.
- Do not use a new battery with an old one.
- Do not mix different types of batteries.

Step 3

Connecting the VCR

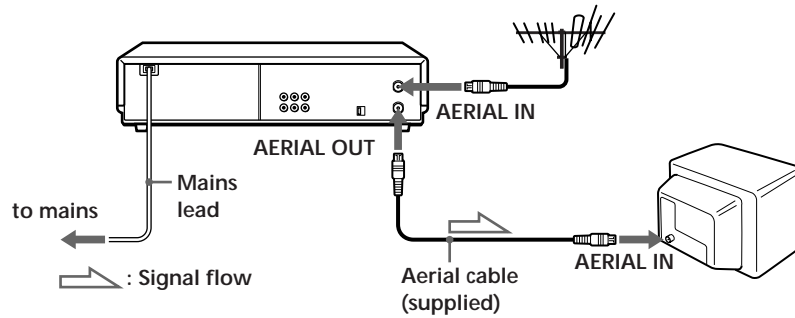

- 1 Disconnect the aerial input cable from your TV and connect it to AERIAL IN on the rear panel of the VCR.

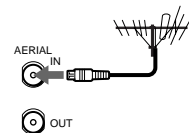

- 2 Connect AERIAL OUT of the VCR and the aerial input of your TV using the supplied aerial cable.

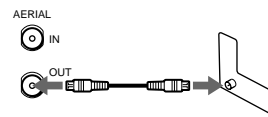

- 3 Connect the mains lead to the mains.

Additional connections

To a TV that has phono type audio/video input jacks

This additional connection improves picture and sound quality. Connect the TV as shown on the right.

If you want to use the Trinitron TV Synchro Play function (see page 21), this connection is necessary. (If your TV has two or more inputs, connect the audio/video cable to the VIDEO IN 1 jacks.)

For SLV-X717

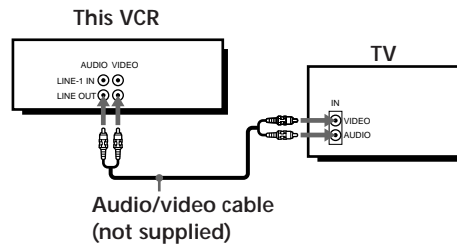

For SLV-X817

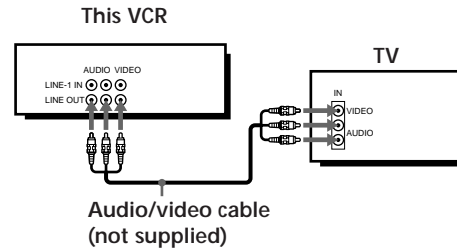

To a stereo system (SLV-X817 only)

You can improve sound quality by connecting a stereo system as shown below.

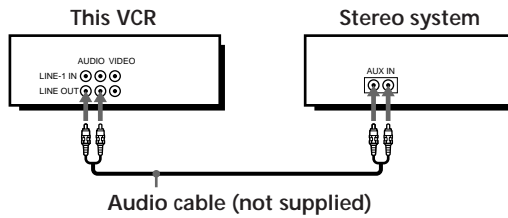

Step 4

Tuning your TV to the VCR

If you have connected your VCR to the TV using the audio/video cable, skip this step.

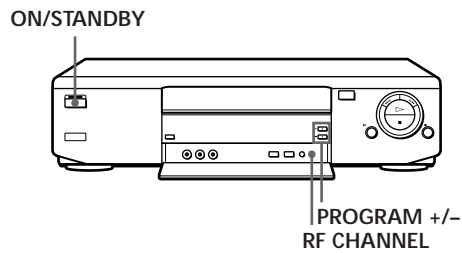

- 1** ON/STANDBY Press ON/STANDBY to turn on the VCR.



- 2** RF CHANNEL Press RF CHANNEL on the VCR.
The factory-preset RF channel appears in the display window.
The VCR signal is output through this channel to the TV.

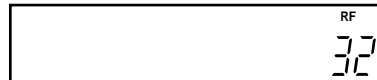

- 3** Turn on your TV and select a programme position for the VCR picture.
This channel will now be referred to as the video channel.

- 4** RF CHANNEL Press RF CHANNEL.
The TV system indicator appears in the display window.
PROGRAM +/- Press PROGRAM +/- (repeatedly) to select the correct TV system.
If you watch the system B/G, select "G." If you watch the system D/K, select "K."



5

Tune the TV to the same channel as that shown in the display window so that the picture on the right appears on the TV screen.

Refer to your TV manual for tuning instructions.

If the picture does not appear clearly, see "To obtain a clear picture from the VCR" below.

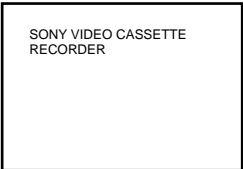

SONY VIDEO CASSETTE
RECORDER

6

Press RF CHANNEL.

You have now tuned your TV to the VCR. From now on, whenever you want to play a tape, set the TV to the video channel.

To check to see if the TV tuning is correct

Set the TV to the video channel and press PROGRAM +/- on the VCR. If the TV screen changes to a different programme each time you press PROGRAM +/-, the TV tuning is correct.

To obtain a clear picture from the VCR

If the picture does not appear clearly in step 5 above, go to step 6 to finish this procedure once. Then start from step 2. After pressing RF CHANNEL in step 2 to display the RF channel, press PROGRAM +/- so that another RF channel appears. Then tune the TV to the new RF channel until a clear picture appears.

Note

- If you set the wrong TV system you may have no sound or sound may be distorted.

Step 5

Selecting a language

You can change the on-screen language from English to Chinese or Arabic.

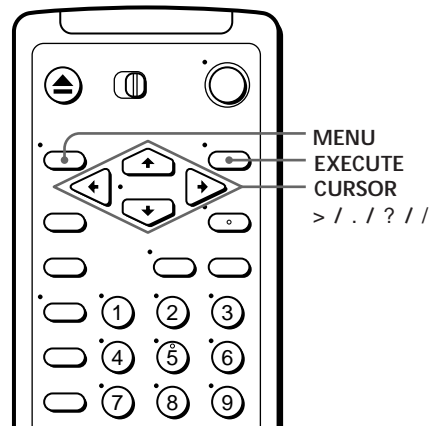

Before you start...

- Turn on the VCR and the TV.
- Set the TV to the video channel.



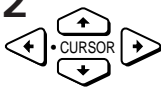

1  Press MENU.

MENU
▶TIMER SET / CHECK SET UP MENU TUNER PRESET CLOCK SET LANGUAGE / 语言 / 言語
SELECT : [↔]
SET : [EXECUTE]

2  Press CURSOR > / . to move the cursor (z) to LANGUAGE and press EXECUTE.

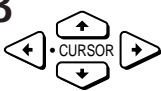
LANGUAGE / 语言 / 言語
• ENGLISH 中文 العربية
SELECT : [v v]
END : [EXECUTE]

3  Press CURSOR > / . to flash the desired language, then press EXECUTE.

LANGUAGE / 语言 / 言語
ENGLISH • 中文 العربية
选择 : [v v]
完毕 : [EXECUTE]

Step 6

Setting the clock

You must set the time and date on the VCR to be able to use the timer recording features properly. You can set the VCR clock using the on-screen display.

Before you start...

- Turn on the VCR and the TV.
- Set the TV to the video channel.

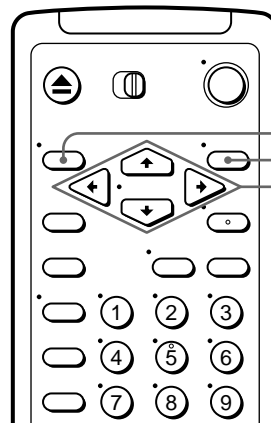



MENU
EXECUTE
CURSOR
>./?//

Getting Started

- 1**  Press MENU.

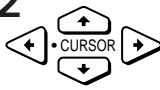
```
MENU
▶TIMER SET / CHECK
SET UP MENU
TUNER PRESET
CLOCK SET
LANGUAGE / 语言 / 言語
SELECT : [↔]
SET : [EXECUTE]
```

- 2**  Press CURSOR >./ to move the cursor (z) to CLOCK SET, then press EXECUTE.
-  EXECUTE

```
CLOCK SET
1.1997 WED 0:00
SELECT : [↔]
SET : [↔]
END : [EXECUTE]
```

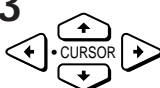
- 3**  Press CURSOR >./ to set the date. The day of the week is set automatically.

```
CLOCK SET
2.1.1997 SAT 0:00
SELECT : [↔]
SET : [↔]
END : [EXECUTE]
```

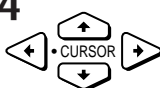
- 4**  Press CURSOR / to flash the month and set the month using CURSOR >./..

```
CLOCK SET
25.1.1997 THU 0:00
SELECT : [↔]
SET : [↔]
END : [EXECUTE]
```

continued

Getting Started | 11

Step 6 : Setting the clock (continued)

5

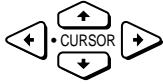

Set the year, hour and minutes in sequence, using CURSOR / to flash the item to be set, and CURSOR >/. to select the digits.

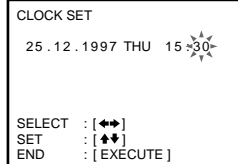

6



Press EXECUTE to start the clock.

Tip

- To change the digits during setting, press CURSOR ? to return to the item to be changed, and select the digits using CURSOR >/..

Note

- The menu disappears automatically if you don't proceed for more than a few minutes.

Step 7

Tuning the VCR

First, we recommend that you preset the receivable channels in your area using automatic presetting. Then, if some channels could not be preset automatically, you can preset them manually; if there are any unwanted channels among the preset ones, you can disable the channels.

Before you start...

- Turn on the VCR and the TV.
- Set the TV to the video channel.

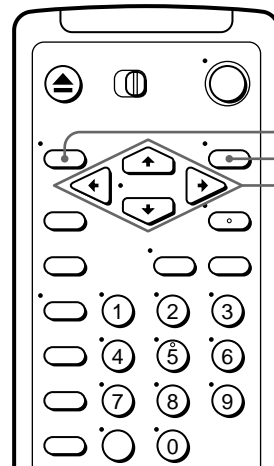

MENU
EXECUTE
CURSOR
>/.?//

Getting Started

Presetting all receivable channels automatically

1  Press MENU.

MENU	
▶TIMER SET / CHECK	
SET UP MENU	
TUNER PRESET	
CLOCK SET	
LANGUAGE / 语言 / 言語	
SELECT : [↕↕]	
SET : [EXECUTE]	

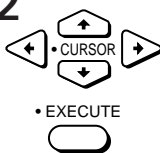
2  Press CURSOR >/. to move the cursor (z) to TUNER PRESET, then press EXECUTE.

TUNER PRESET	PROG 1
NORMAL / CATV	•NORM CATV
AUTO PRESET	
▶CHANNEL SET	1
AFT	•ON OFF
FINE TUNING	
SELECT : [↕↕]	
SET : [↕↕]	

continued

Step 7 : Tuning the VCR (continued)

3

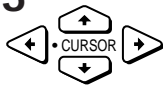

Press CURSOR >././?// to move the cursor (z) to NORMAL/CATV, then select NORM.

To preset CATV channels, select CATV.

TUNER PRESET	PROG 1
▶NORMAL / CATV	•NORM CATV
AUTO PRESET	
CHANNEL SET	1
AFT	•ON OFF
FINE TUNING	
SELECT : [↔]	
SET : [↔]	

4

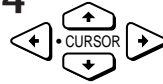

Press CURSOR >./ to move the cursor (z) to AUTO PRESET, then press EXECUTE.



All receivable channels are preset in numerical sequence. When no more receivable channels can be found, presetting stops and the picture from the lowest numbered channel is displayed on the TV screen.

TUNER PRESET	PROG 1
NORMAL / CATV	•NORM CATV
▶AUTO PRESET	
CHANNEL SET	1
AFT	•ON OFF
FINE TUNING	
▲▲▲▲▲▲▲▲▲▲	
-PLEASE WAIT-	
▼▼▼▼▼▼▼▼▼▼	

Presetting channels manually

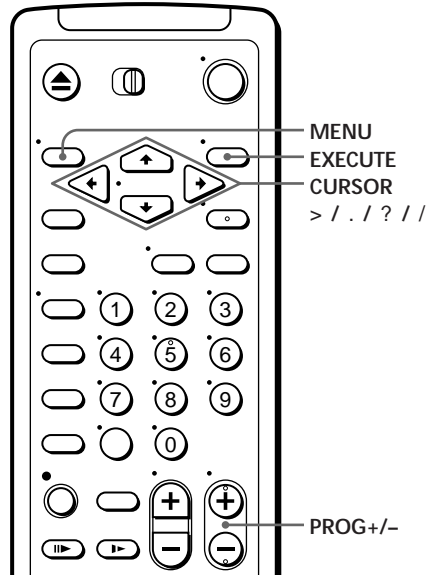

Getting Started

1 • MENU
Press MENU.

MENU
▶TIMER SET / CHECK
SET UP MENU
TUNER PRESET
CLOCK SET
LANGUAGE / 语言 / 言語
SELECT : [▲▲]
SET : [EXECUTE]

2 • EXECUTE
Press CURSOR >/. to move the cursor (z) to TUNER PRESET, then press EXECUTE.

TUNER PRESET	PROG10
NORMAL / CATV	•NORM CATV
AUTO PRESET	
▶CHANNEL SET	21
AFT	•ON OFF
FINE TUNING	
SELECT : [▲▲]	
SET : [▲▲]	

3 • CURSOR
Press CURSOR >/./?// to move the cursor (z) to NORMAL/CATV, then select NORM.
To preset CATV channels, select CATV.

TUNER PRESET	PROG10
▶NORMAL / CATV	•NORM CATV
AUTO PRESET	
CHANNEL SET	21
AFT	•ON OFF
FINE TUNING	
SELECT : [▲▲]	
SET : [▲▲]	

continued

Step 7 : Tuning the VCR (continued)

4

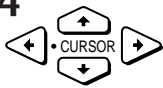

Press CURSOR >/< to move the cursor (z) to CHANNEL SET.

TUNER PRESET	PROG10
NORMAL / CATV	•NORM CATV
AUTO PRESET	
▶CHANNEL SET	21
AFT	•ON OFF
FINE TUNING	
SELECT	: [↕]
SET	: [↔]

5



Press PROG +/- to select the programme position.

Selected programme position

TUNER PRESET	PROG14
NORMAL / CATV	•NORM CATV
AUTO PRESET	
▶CHANNEL SET	21
AFT	•ON OFF
FINE TUNING	
SELECT	: [↕]
SET	: [↔]

6

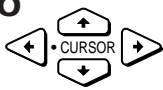

Press CURSOR / repeatedly until the channel you want is displayed. Pressing CURSOR ? goes back to the previous channels.

The channels are scanned in the following order:

TUNER PRESET	PROG14
NORMAL / CATV	•NORM CATV
AUTO PRESET	
▶CHANNEL SET	35
AFT	•ON OFF
FINE TUNING	
SELECT	: [↕]
SET	: [↔]

Channel coverage	System D/K	System B/G
VHF	R1-R12	E2-E12
UHF	R21-R69	E21-E69
CATV (TV distribution)	—	S1-S41, S01-S05

If you know the number of the channel you want, press the programme number buttons. For example, for channel 5, first press "0" and then press "5."

7

To allocate another channel to another programme position, repeat steps 4 to 6.

8



Press EXECUTE.

Disabling unwanted programme positions

After tuning the TV channels, you can disable unused programme positions. The disabled positions will be skipped later when you press the PROG +/- buttons.

- 1 Press MENU, then select TUNER PRESET and press EXECUTE.
- 2 Select CHANNEL SET.
- 3 Press PROG +/- until the programme position you want to disable appears beside "PROG" on the TV screen.
- 4 Press programme number button "0" twice to display the number "0" beside CHANNEL SET.
- 5 Repeat steps 3 and 4 for other positions you want to disable.
- 6 Press EXECUTE.

If the picture is not clear

Normally, the Auto Fine Tuning (AFT) function automatically tunes in channels clearly. If, however, the picture is not clear, you may also use the manual tuning function.

- 1 Press PROG +/- to select the programme position for which you cannot obtain a clear picture.
- 2 Press MENU, then select TUNER PRESET and press EXECUTE.
- 3 Select FINE TUNING. The fine tuning meter appears.

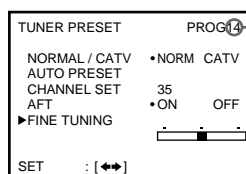

Selected programme position

- 4 Press CURSOR ?// to get a clearer picture, then press EXECUTE. Note that the AFT (Auto Fine Tuning) setting switches to OFF.

Note

- The menu disappears automatically if you don't proceed for more than a few minutes.

Playing a tape

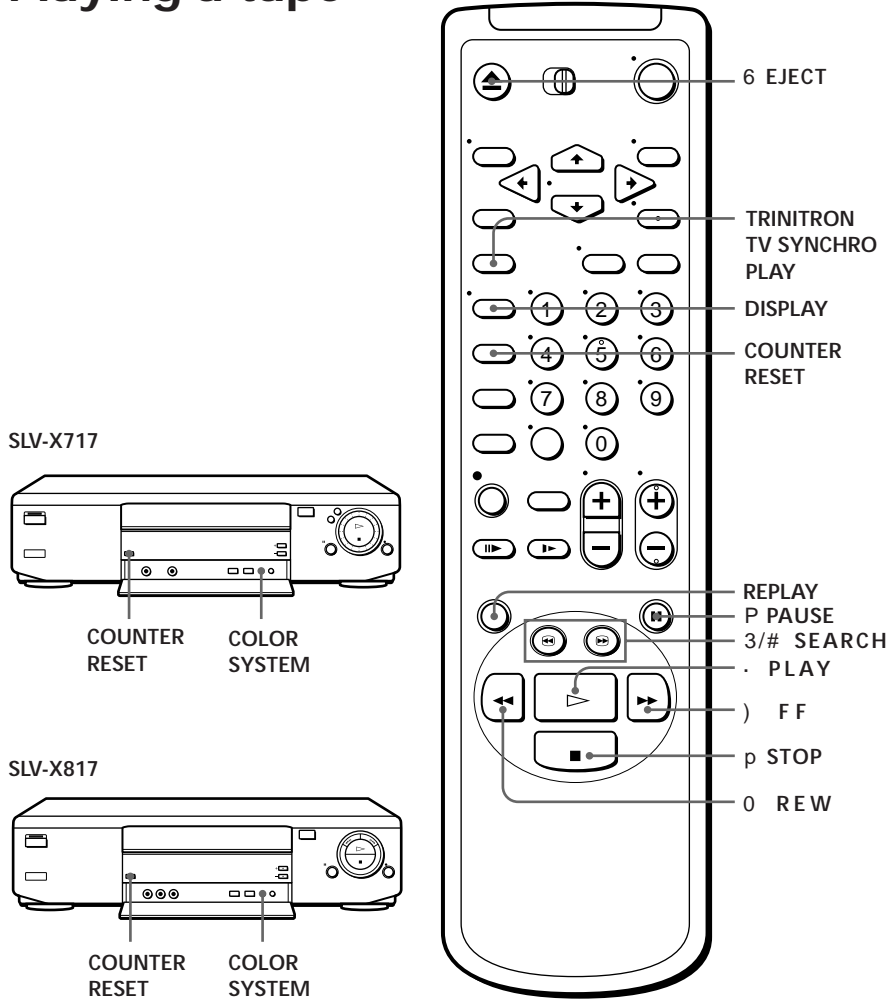

1 Turn on your TV and set it to the video channel.

2 Insert a tape.
The VCR turns on and starts playing automatically if you insert a tape with its safety tab removed.

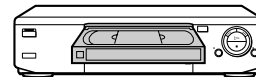

3Press **·** PLAY.

When the tape reaches the end, it will rewind automatically.

Additional tasks

To	Press
Stop play	p STOP
Pause play	P PAUSE
Resume play after pause	P PAUSE or · PLAY
Search forward) FF or # SEARCH during playback
Search backward	0 REW or 3 SEARCH during playback
Fast-forward the tape) FF during stop
Rewind the tape	0 REW during stop
Eject the tape	6 EJECT

Replaying a recently watched scene

You can immediately rewind and playback the scene you want to watch again.

During playback, press REPLAY up to four times. The VCR rewinds the tape 10 seconds for each press of the button, and restarts playback.

To set the colour system

If streaks appear during playback, press COLOR SYSTEM on the VCR to conform to the system that the tape was recorded in. (Normally, the color system is correctly set whenever the tape is inserted.)

If your tape was recorded in	Press COLOR SYSTEM until the indication below appears in the display window.
PAL	PAL
NTSC	NTSC
MESECAM	PAL

continued

Playing a tape (continued)

To play an NTSC-recorded tape

Set NTSC PB at the rear of the VCR according to the colour system of your TV.

If your TV is	Set NTSC PB to
PAL	ON PAL TV
NTSC 4.43	NTSC 4.43
NTSC 3.58	NTSC 3.58

To use the time counter

At the point on the tape that you want to find later, press COUNTER RESET. The counter in the display window resets to "0H00M00S." Search for the point afterwards by referring to the counter.

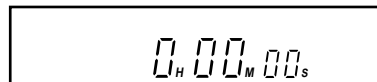

To display the counter on the TV screen, press DISPLAY.

Notes

- The counter resets to "0H00M00S" whenever a tape is reinserted.
- The counter stops counting when it comes to a portion with no recording.
- If a tape has portions recorded in both PAL and NTSC systems, the time counter reading will not be correct. This is due to the difference between the counting cycles of the two video systems.
- Depending on your TV, the following may occur while playing an NTSC-recorded tape:
 - the picture is black and white
 - the picture shakes
 - no picture appears on the TV screen
 - black streaks appear horizontally on the TV screen
 - the colour density increases or decreases.

Turning on the VCR and TV, and starting playback automatically (Trinitron TV Synchro Play)

You can only use this function if your TV is made by Sony (Trinitron TV).

How to connect to use this function

Connect the VCR and TV with the audio/video cable (see “To a TV that has phono type audio/video input jacks” on page 7.) Be sure to connect the audio/video cable to the VIDEO IN 1 jacks on the TV if the TV has two inputs or more. The TV must be placed where it will respond to the remote commander while you are pointing it at the VCR.

Operation

Make sure that the TV's power is in standby mode.

Press TRINITRON TV SYNCHRO PLAY and hold the remote commander in place for about two seconds.

The VCR and TV turn on, and the TV is set to VCR reception. If there is a tape in the VCR, playback starts automatically.



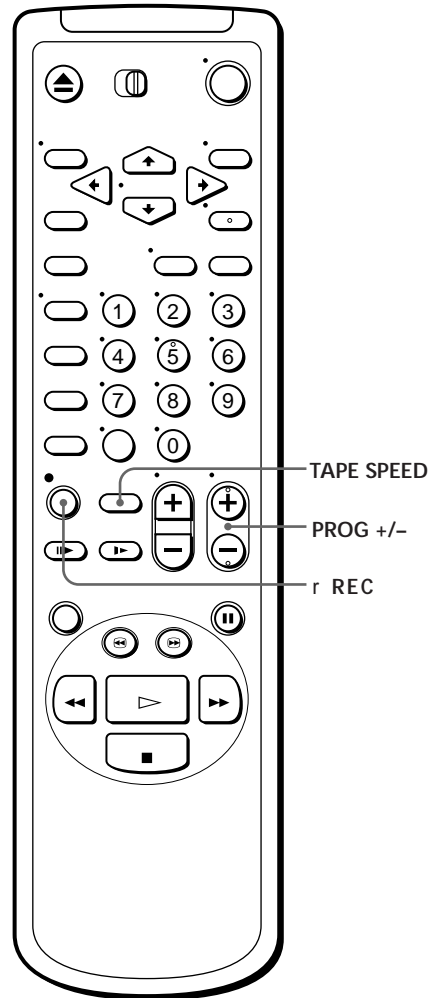

Notes

- If the Trinitron TV Synchro Play function does not work properly:
 - Wait a few moments, and press the button again.
 - Replace both of the batteries with new ones, and press the button again.Note that this function may not operate some Sony TVs because of the remote commander's signal limitations.
- Do not press TRINITRON TV SYNCHRO PLAY while playing back a video tape. If you do so, the TV's input source will momentarily switch to the TV's tuner.

Recording TV programmes



- 1** Turn on your TV and set it to the video channel.
- 2** Insert a tape with its safety tab in place.

- 3**  **•PROG** Press PROG +/- to select the programme position you want to record.
- 
- 4**  **TAPE SPEED** Press TAPE SPEED to select the tape speed, SP or LP. LP provides recording time twice as long as SP, however, SP produces better picture and audio quality.
- 
- 5**  **•REC** Press r REC to start recording.

To stop recording

Press p STOP.

To check the remaining tape length

Press DISPLAY during playback or recording. The white bar indicates the approximate length of tape remaining.

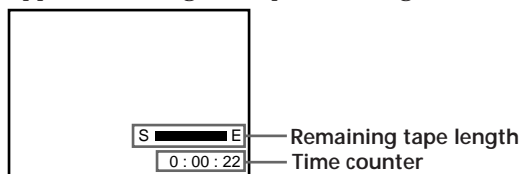
**To watch another TV programme while recording**

- 1** If the TV is connected to the VCR using an audio/video cable, set the TV to TV input. If the TV is connected to the VCR using only the aerial cable, skip this step.
- 2** Select another programme position on the TV.

continued

Recording TV programmes (continued)

To save a recording

To prevent accidental erasure, break off the safety tab as illustrated. To record on a tape again, cover the tab hole with adhesive tape.



To record NTSC colour system programmes

NTSC colour signals can be recorded on this VCR.

For tape speed, select SP or EP in step 4.

EP provides recording time three times as long as SP, however, SP produces better picture quality.

When playing back, the VCR automatically detects the tape speed.

Tips

- To select a programme position, you can use the programme number buttons on the remote commander. For two-digit numbers, press the ? (ten's digit) button followed by the number buttons.
- You can select a video source from the LINE-1 IN or LINE-2 IN jacks using INPUT SELECT.
- The display appears on the TV screen indicating information about the tape, but the information won't be recorded on the tape.
- If you don't want to watch TV while recording, you can turn off the TV.

Notes

- The display does not appear during still (pause) mode or slow-motion playback.
- The display will not appear while playing an NTSC-recorded tape.

Recording TV programmes using the timer

You can preset up to eight programmes at a time.

Before you start...

- Check that the VCR clock is set to the correct time.
- Insert a tape with its safety tab in place. Make sure the tape is longer than the total recording time.
- Turn on your TV and set it to the video channel.

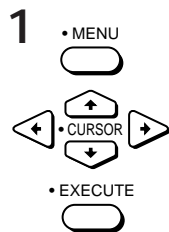
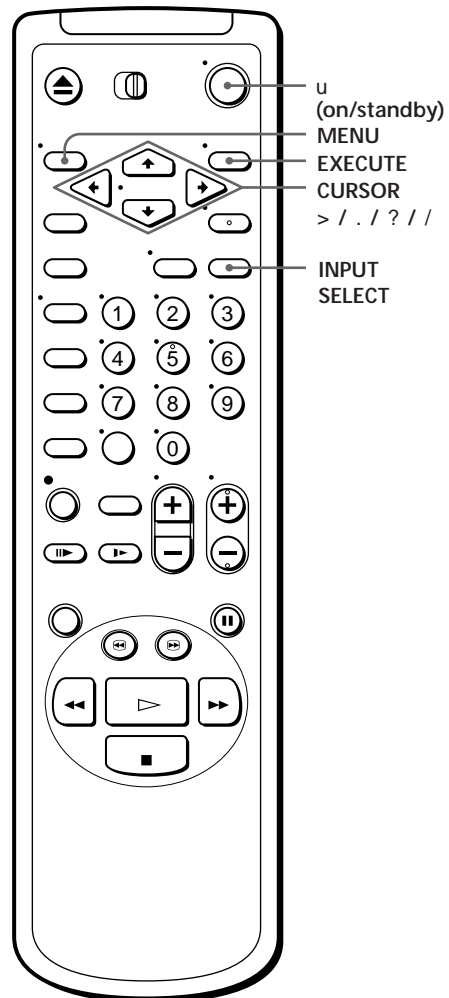

Press MENU and select TIMER SET/CHECK, then press EXECUTE.

TIMER SET / CHECK	25.12 TH
DATE	START STOP PROG
▶---	---
---	---
---	---
---	---
---	---
---	---
---	---
---	---

continued

Recording TV programmes using the timer (continued)

2

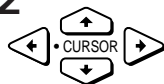

Set the date, start and stop times, programme position, and tape speed:

- 1 Press CURSOR / to flash each item in turn.
- 2 Press CURSOR >/ to set each item.

TIMER SET / CHECK	25 . 12 TH	TH
DATE	START	STOP PROG
→ 25 . 12 TH	- : -	- : - - - SP
Y Y Y Y	- : -	- : - - -
- - -	- : -	- : - - -
- - -	- : -	- : - - -
- - -	- : -	- : - - -
- - -	- : -	- : - - -
- - -	- : -	- : - - -
- - -	- : -	- : - - -

To correct a setting, press CURSOR ? to return to that setting and reset.

To record the same programme every day or the same day every week, press CURSOR . while the date is flashing. For details, see “Daily/weekly recording” on page 27.

To record from a source connected to the LINE-1 IN or LINE-2 IN jacks, press INPUT SELECT to display “L1” or “L2” in the “PROG” position.

3

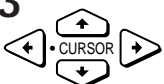

Press CURSOR / to confirm the setting.

The cursor (z) appears at the beginning of the line. To enter another setting, move the cursor to the next line and repeat step 2.

4



Press EXECUTE.

5



Press u to turn off the VCR.

The TIMER indicator appears in the display window and the VCR stands by for recording.

To record from other equipment, leave the connected equipment switched on.

To stop recording

To stop the VCR while recording, press p STOP.

To use the VCR after setting the timer

To use the VCR before a timer recording begins, just press u. The TIMER indicator turns off and the VCR switches on. Remember to press u to reset the VCR after using the VCR.

You can also do the following tasks while the VCR is recording:

- Reset the counter.
- Display tape information on the TV screen.
- Check the timer settings.
- Watch another TV program.

Daily/weekly recording

In step 2 above, press CURSOR . to select the recording pattern. Each time you press CURSOR ., the indication changes as shown below. Press CURSOR > to change the indication in reverse order.

the current date n SU-SA n MO-SA n MO-FR n EVERY SA
n EVERY MO n EVERY SU n 1 month later n (dates count down)
n the current date

Tips

- To set the programme position, you can also use the PROG +/- or programme number buttons.
- To set the tape speed, you can also use TAPE SPEED.
- To record NTSC signals, set the tape speed to SP or EP. To set the EP mode, display "LP" in the tape speed position.

Note

- "TIMER" flashes in the display window when you press u with no tape inserted.

Playing/searching at various speeds

SLV-X717

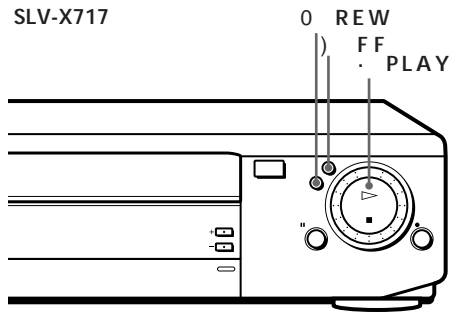

SLV-X817

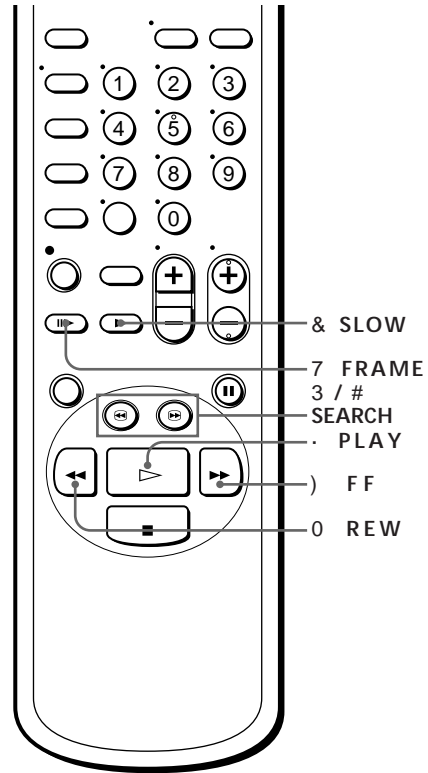
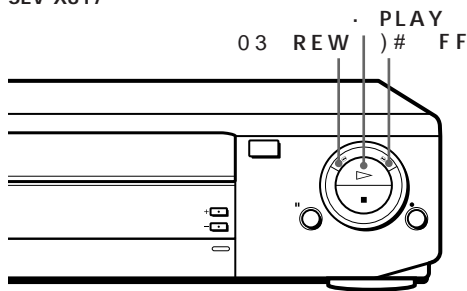

Playback options	Operation
Fast-forward/rewind	During stop, press) FF or 0 REW.
View the picture during fast-forward or rewind	During fast-forward, hold) FF down. During rewind, hold 0 REW down.
Play at high speed	During playback or pause, press # SEARCH or 3 SEARCH. To change direction, press the other one.
Play in slow motion	During playback or pause, press & SLOW.
Play frame by frame	During pause, press 7 FRAME. Hold the button down to play one frame each second.
Rewind and start play	During stop, hold 0 REW down <u>on the VCR</u> , and press · PLAY <u>on the VCR</u> .

To resume normal playback

Press · PLAY.

Using the CLICK SHUTTLE ring (SLV-X717 only)

With the CLICK SHUTTLE ring, you can operate a variety of playback options.

During playback or pause, turn the CLICK SHUTTLE ring clockwise or anticlockwise. Each change in the CLICK SHUTTLE ring position changes the playback mode, and the corresponding mark appears on the TV screen for a few seconds in the following way if the on-screen display function is on:

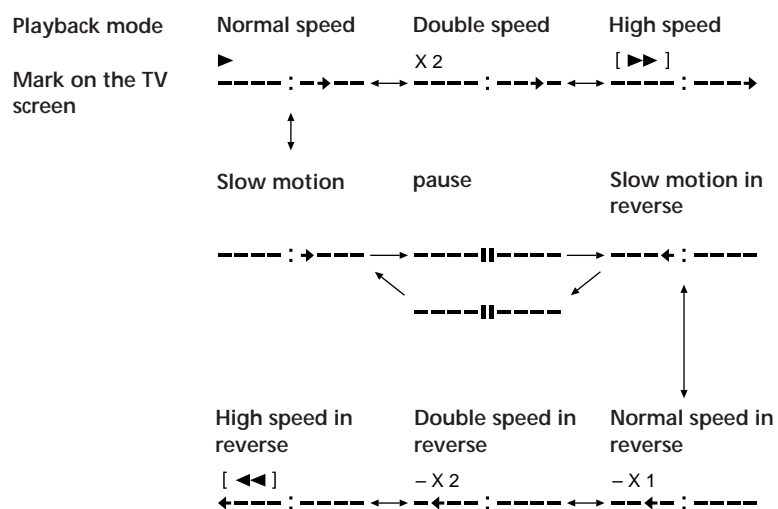
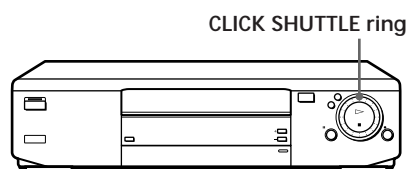

Tip

- Adjust the picture using TRACKING +/- on the VCR if:
 - streaks appear while playing in slow motion
 - bands appear at the top or bottom while pausing
 - the picture shakes while pausing.

Notes

- The playback sound is muted during these operations.
- In LP mode, noise may appear or there may be no colour.
- If the playback mode mark doesn't appear on the TV screen, press DISPLAY.

Recording TV programmes using the quick timer

After starting recording in the normal way, you can have the VCR stop recording automatically after a specified duration.

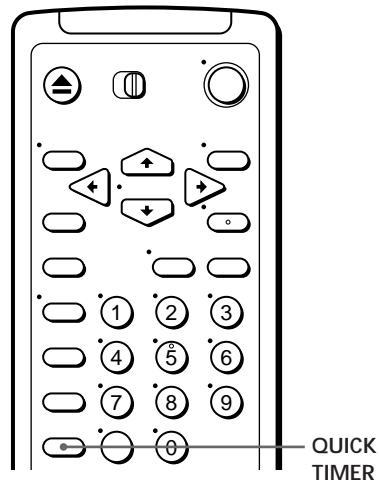

- 1 While recording, press QUICK TIMER once.

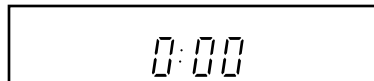

- 2 Press QUICK TIMER repeatedly to set the duration.
Each press advances the time in increments of 30 minutes.

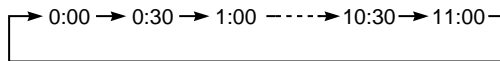

The duration decreases minute by minute to 0:00, then the VCR stops recording and turns off automatically.

To extend the duration

Press QUICK TIMER repeatedly to set to the new duration.

To stop recording

To stop the VCR while recording, press p STOP.

Tip

- You can also set the quick timer and start recording during the stop mode.

Checking/ changing/ cancelling timer settings

Before you start...

- Turn on your TV and set it to the video channel.

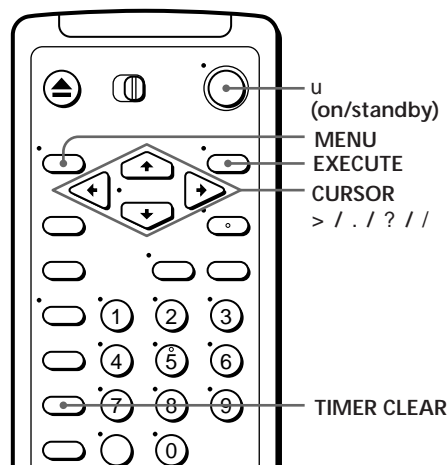

- 1 Press u to turn on the VCR.
- 2 Press MENU and select TIMER SET/CHECK:
 - If you want to change a setting, go on to the next step.
 - If you do not need to change the settings, press EXECUTE, then turn off the VCR to return to recording standby.
- 3 Press CURSOR >/. to select the setting you want to change or cancel:
 - To change the setting, press CURSOR ?// to flash the item you want to change, and press CURSOR >/. to reset it. Then, press CURSOR / repeatedly until the cursor (z) appears at the beginning of the line.
 - To cancel the setting, press TIMER CLEAR.
- 4 Press EXECUTE.
If any settings remain, turn off the VCR to return to recording standby.

TIMER SET / CHECK	25.12 TH
DATE	START STOP PROG
▶ 6.1 TU	7:00 8:00 6 SP
8.1 TH	21:00 0:00 50 LP
MO-SA	0:12 13:00 27 LP
EVERY SU	23:00 0:00 L2 SP
---	---
---	---
---	---
---	---
---	---

When the timer settings overlap

The programme that starts first has priority and the second programme starts recording only after the first programme has finished. If the programmes start at the same time, the programme listed first in the menu has priority.

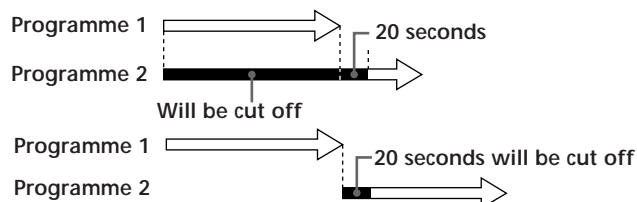

Additional Operations | 31

Recording stereo programmes (SLV-X817 only)

The VCR can only record stereo and bilingual programmes through the line input. When stereo or bilingual sound is input through the line input, "STEREO" appears on the screen and in the display window. You cannot select the sound to listen.

Selecting the sound during playback

Press AUDIO MONITOR to select the sound you want.

To listen to	On-screen display	Display window
Stereo/main and sub (left and right channels)	STEREO	STEREO
Left channel/main	LCH	STEREO
Right channel/sub	RCH	STEREO
Standard sound*	No indicator	No indicator

* The mixed sound of left and right channels (monaural)

How sound is recorded on a video tape

The VCR records sound onto two separate tracks. Hi-fi audio is recorded onto the main track along with the picture. Monaural sound is recorded onto the normal audio track along the edge of the tape.

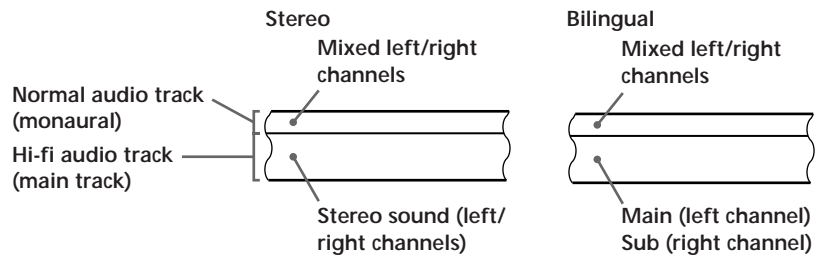



Notes

- To listen to playback sounds in stereo, you must use the AUDIO OUT connections.
- When you play a tape recorded in monaural, the sound is heard in monaural regardless of the AUDIO MONITOR setting.
- If the AUDIO MONITOR button does not function, check that AUDIO MIX in the SET UP MENU is set to OFF. For details, see page 34.

Adjusting the picture

Adjusting the tracking

Although the VCR automatically adjusts the tracking when playing a tape (the tracking indicator  flashes in the display window, then goes off), distortion may occur if the tape was recorded in poor condition. If so, manually adjust the tracking.

Press the TRACKING +/- buttons on the VCR to display the tracking meter. The distortion should disappear as you press one of the two buttons (The  indicator lights up.) To resume automatic tracking adjustment, eject the tape and restart it.

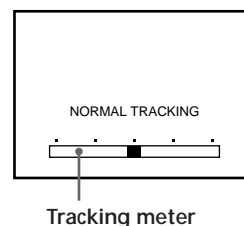

About Adaptive Picture Control (APC)

Adaptive Picture Control (APC) automatically improves recording and playback quality by adjusting the VCR to the condition of the video heads and tape. To maintain better picture quality, we recommend that you set APC to ON in the SET UP MENU (with the APC indicator in the display window lit).

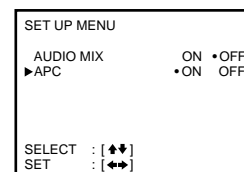

APC playback

The APC function automatically works on all types of tapes, including rental tapes and tapes that were not recorded with APC.

APC recording

Whenever you insert a tape and first start recording, the VCR adjusts to the tape using the APC function (the APC indicator flashes rapidly). This adjustment is retained until the tape is ejected.

To deactivate the APC

Press MENU and select SET UP MENU, then set APC to OFF. The APC indicator in the display window goes off.

Note

- There is a delay of a few seconds before the VCR actually starts recording while the VCR analyses the tape. To avoid the delay, first set the VCR to recording pause (the APC indicator flashes slowly) and press **r** REC to have the VCR analyse the tape (the APC indicator flashes rapidly). After the APC indicator stops flashing, press **P** PAUSE to start recording immediately. If you want to start recording quickly without using the APC function, first set the VCR to recording pause (the APC indicator flashes slowly) and press **P** PAUSE to start recording.

Changing menu options

- 1 Press MENU, then select SET UP MENU.

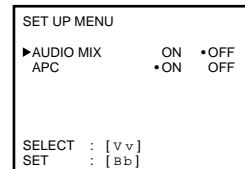

- 2 Press CURSOR >/. to select the option to change, then press CURSOR ?// to change the setting.
- 3 Press EXECUTE to return to the original screen.

Menu choices

Initial settings are indicated in bold print.

Menu option	Set this option to
AUDIO MIX (SLV-X817 only)	ON to listen to the hi-fi and normal audio tracks at the same time. The AUDIO MONITOR button will not function. OFF to listen to hi-fi and normal audio tracks separately. Select the sound using the AUDIO MONITOR button.
APC	ON to switch on the APC (Adaptive Picture Control) function and improve picture quality, OFF to switch off APC.

Editing with another VCR

How to connect to record on this VCR

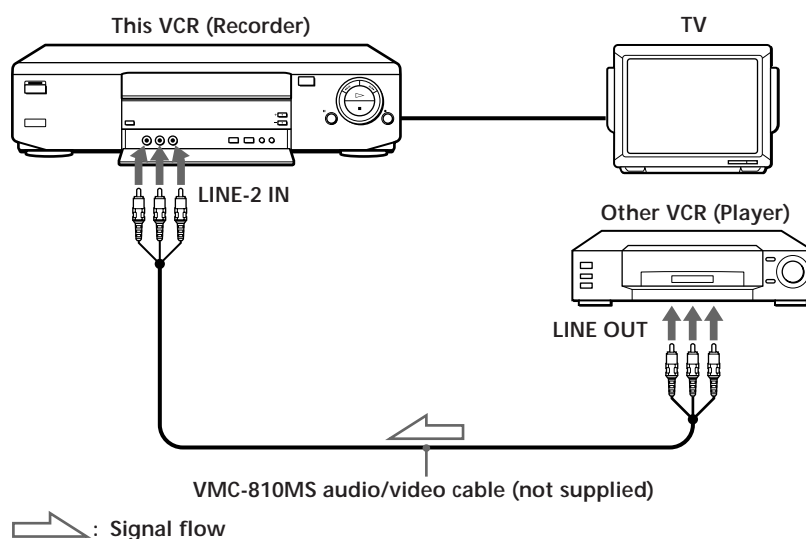

Notes

- (SLV-X717 only)
Use commercially available connecting cable like the Sony VMC-710M/720M.
If the other VCR has the AUDIO L and R jacks, use a connecting cable like the Sony VMC-910MS.
- Make sure you connect the plugs to jacks of the same colour.
- If the other VCR is a monaural type, connect the audio plug to the AUDIO L (white) jack. The sound is recorded on both right and left channels. When connecting to the AUDIO R (red) jack, the sound is recorded only on the right channel.
- If you connected this VCR to both the LINE IN and LINE OUT jacks of the other VCR, select the input correctly to prevent a humming noise.
- You can also use the LINE-1 IN jacks instead.

continued

Editing with another VCR (continued)

Operation (when recording on this VCR)

Before you start editing

- Turn on your TV and set it to the video channel.
- Press INPUT SELECT to display “L2” in the display window.
- Press TAPE SPEED to select the tape speed (SP or LP for the PAL system, and SP or EP for the NTSC system).

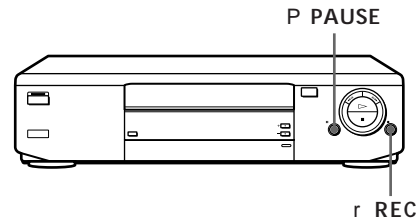

- 1** Insert a source tape with its safety tab removed into the other (playback) VCR. Search for the point to start playback and set it to playback pause.
- 2** Insert a tape with its safety tab in place into this (recording) VCR. Search for the point to start recording and press P PAUSE.
- 3** Press r REC on this VCR and set it to recording pause.
- 4** To start editing, press the P PAUSE buttons on both VCRs at the same time.

To stop editing

Press the p STOP buttons on both VCRs.

Tips

- To edit more precisely, press the P PAUSE buttons on the VCRs to release pause.
- To cut out unwanted scenes while editing, press P PAUSE on this VCR when an unwanted scene begins. When it ends, press P PAUSE again to resume recording.

Note

- If you start recording following the procedure above, the VCR won't start recording with the APC function. To record a tape with the APC function, press r REC again during recording pause in step 3 so that the VCR analyses the tape. Then when you start recording in step 4, press P PAUSE after the APC indicator stops flashing. If you press P PAUSE before the APC indicator stops flashing, the APC function is cancelled.

Audio dubbing

You can replace the original sound with the desired one later. Connection is the same as that in "Editing with another VCR" on page 35.

For SLV-X817

The monaural sound previously recorded is replaced while the original hi-fi sound remains unchanged. Use this feature to add commentary to a tape that you have recorded with a camcorder.

Before you start dubbing

- Turn on your TV and set it to the video channel.
- Press INPUT SELECT to display "L2" in the display window.

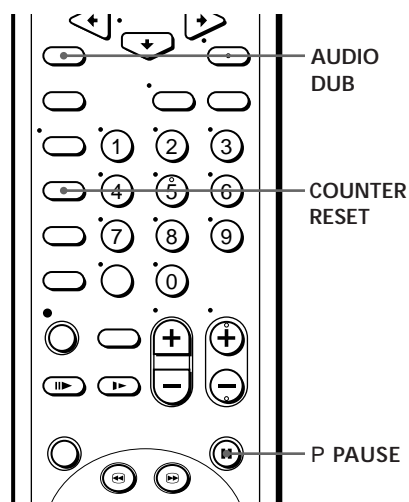

- 1 Insert a source tape into the playback VCR or the stereo system. Search for the point to start playback and set it to playback pause.
- 2 Insert a prerecorded tape into this (recording) VCR. Search for the end of the scene to be replaced and press P PAUSE.
Make sure that the tape has its safety tab in place.
- 3 Press COUNTER RESET on this VCR to reset the counter to "0H00M00S."
- 4 Rewind the prerecorded tape to the beginning of the scene to be replaced.
The VCR pauses.
- 5 Press AUDIO DUB.
The audio dubbing indicator ⊖ appears in the display window.
- 6 To start dubbing, press the P PAUSE buttons on this VCR and the other VCR (or stereo system) at the same time.
When the counter reaches "0H00M00S," audio dubbing stops automatically.

To stop while editing

Press the p STOP buttons on this VCR and the other VCR (or stereo system).

To listen to both the hi-fi and normal audio (SLV-X817 only)

Set AUDIO MIX to ON in the SET UP MENU (page 34). Use this feature to listen to dubbed audio over the original hi-fi audio. When AUDIO MIX is set to ON, the AUDIO MONITOR button does not function. Remember to reset AUDIO MIX to OFF after playing the tape.

Troubleshooting

If you have any questions or problems not covered below, please consult your nearest Sony service facility.

	Symptom	Remedy
Power	The ON/STANDBY switch does not function.	<ul style="list-style-type: none"> Connect the mains lead to mains securely.
	The power is turned on but the VCR does not operate.	<ul style="list-style-type: none"> Moisture condensation occurs. Turn the power off, unplug the mains lead, and leave the VCR to dry for over an hour.
Clock	The clock has stopped and “--:--” lights in the display window.	<ul style="list-style-type: none"> The clock stops if the VCR is disconnected from the mains for more than an hour. Reset the clock (and timer).
Playback	The playback picture does not appear on the TV screen.	<ul style="list-style-type: none"> Make sure the TV is set to the video channel. If you are using a monitor, set it to video input.
	The picture is not clear.	<ul style="list-style-type: none"> Adjust the tracking with the TRACKING +/- buttons. Make sure the colour system is correctly set to the system that the tape was recorded in. The video heads are dirty (see below). Clean the video heads using the Sony V-25CL video head cleaning cassette. If this cleaning cassette is not available in your area, have the heads cleaned at your nearest Sony service facility (a standard service charge will be required). Do not use a commercially available wet-type cleaning cassette, as it may damage the video heads. The video heads may have to be replaced. Consult your local Sony service facility for more information.
	The picture rolls vertically during picture search.	<ul style="list-style-type: none"> Adjust the vertical hold control on the TV or monitor.
	The picture has no sound.	<ul style="list-style-type: none"> The tape is defective. Use a new tape.
	The sound is unstable or has an echo.	<ul style="list-style-type: none"> When you play a tape with the same sound recorded on both the hi-fi and normal sound tracks, make sure the AUDIO MIX option in the SET UP MENU is set to OFF. (SLV-X817 only)

Symptoms caused by contaminated video heads

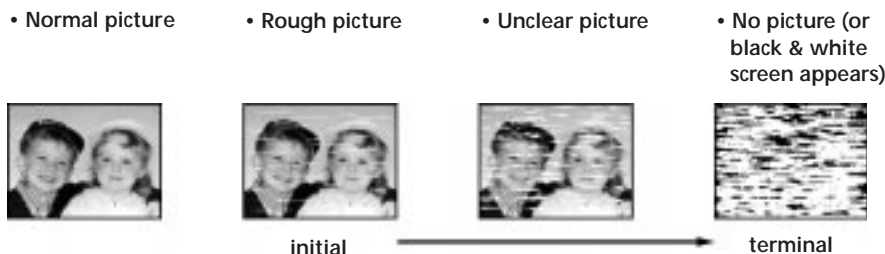

	Symptom	Remedy
Recording	No TV programmes appear on the TV screen.	<ul style="list-style-type: none"> • Make sure the TV is set to the video channel. If you are using a monitor, set it to video input.
	TV reception is poor.	<ul style="list-style-type: none"> • Adjust the TV aerial. • Make sure the TV system is correctly set for your TV.
	The tape starts playing as soon as it is inserted.	<ul style="list-style-type: none"> • The safety tab has been removed. To record on this tape, cover the tab hole.
	The tape is ejected when you press r REC.	<ul style="list-style-type: none"> • Check that the safety tab has not been removed.
	Nothing happens when you press r REC.	<ul style="list-style-type: none"> • Make sure the tape is not at its end. • Select the correct source with the INPUT SELECT buttons. Select a programme position when recording TV programmes; select "L1" or "L2" when recording from other equipment.
Timer recording	The timer does not operate.	<ul style="list-style-type: none"> • Check that the clock is set. • Make sure a tape has been inserted. • Check that the safety tab has not been removed. • Make sure the tape is not at its end. • Make sure a programme has been set for timer recording. • Make sure your timer settings have not already passed the current time. • The clock stops if the VCR is disconnected from the mains for more than an hour. Reset the clock and timer.
	No tape can be inserted.	<ul style="list-style-type: none"> • Check that a tape isn't already in the tape compartment.
Others	The remote commander does not function.	<ul style="list-style-type: none"> • Make sure you are pointing the remote commander at the remote sensor on the VCR. • Replace all the batteries in the remote commander with new ones if they are weak. • Make sure the [TV] / [VIDEO] remote control switch is set correctly.
	The tracking indicator does not appear on the screen.	<ul style="list-style-type: none"> • The recording condition of the tape is very poor and tracking cannot be adjusted, or the NTSC system is being used.
	The VCR needs to be cleaned.	<ul style="list-style-type: none"> • Clean the cabinet, panel and controls with a dry, soft cloth, or a soft cloth slightly moistened with a mild detergent solution. Do not use any type of solvent, such as alcohol or benzine.

Specifications

System

Channel coverage
VHF R1 to R12, E2 to E12
UHF E21 to E69, R21 to R69
CATV S01 to S05, S1 to S41

RF output signal
UHF channels 21 to 69

Aerial out
75-ohm asymmetrical aerial socket

Inputs and outputs

LINE-1 IN and LINE-2 IN
VIDEO IN, phono jack (1 each)
Input signal: 1 Vp-p, 75 ohms,
unbalanced, sync negative
AUDIO IN,
phono jack (1 each) (SLV-X717)
phono jack (2 each) (SLV-X817)
Input level: 327 mVrms
Input impedance: more than 47 kilohms

LINE OUT
VIDEO OUT, phono jack (1)
Output signal: 1 Vp-p, 75 ohms,
unbalanced, sync negative
AUDIO OUT,
phono jack (1) (SLV-X717)
phono jack (2) (SLV-X817)
Standard output: 327 mVrms
Load impedance: 47 kilohms
Output impedance: less than 10 kilohms

General

Power requirements
110 – 240 V AC, 50/60 Hz

Power consumption
19 W

Operating temperature
5°C to 40°C

Storage temperature
-20°C to 60°C

Dimensions
Approx. 430 x 109 x 308 mm (w/h/d)
including projecting parts and controls

Mass
Approx. 4.5 kg

Supplied accessories

Remote commander (1)
R6 (Size AA) batteries (2)
Aerial cable (1)
Plug adaptor (1) (SLV-X717ME/SG and SLV-X817ME/SG only)

Design and specifications are subject to change without notice.

Index to parts and controls

Refer to the pages indicated in parentheses () for details.

Front panel (SLV-X717)

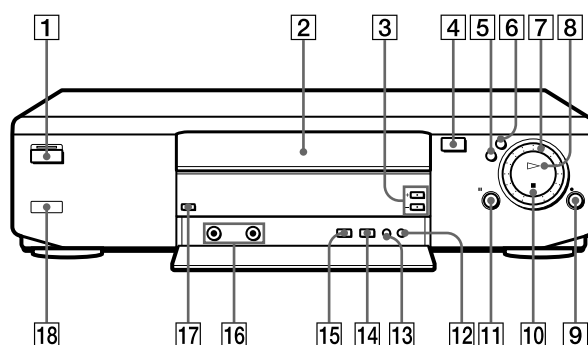

- | | |
|--|--------------------------------------|
| 1 ON/STANDBY switch/indicator (8) | 0 p STOP button (19, 23) |
| 2 Tape compartment | ! j P PAUSE button (19, 36) |
| 3 PROGRAM/TRACKING +/- buttons (8, 33) | !™ RF CHANNEL button (8) |
| 4 EJECT button (19) | ! £ COLOR SYSTEM button (19) |
| 5 REW button (19, 28) | ! ¢ TAPE SPEED button (23) |
| 6) FF button (19) | ! INPUT SELECT button (24, 26) |
| 7 CLICK SHUTTLE ring (29) | ! § LINE-2 IN AUDIO/VIDEO jacks (35) |
| 8 . PLAY button (19, 28) | ! ¶ COUNTER RESET button (20) |
| 9 r REC button (23) | ! • Remote sensor (5) |

continued

Index to parts and controls (continued)

Front panel (SLV-X817)

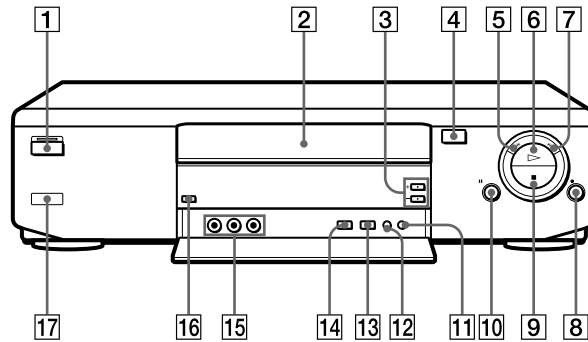

- | | |
|--|--|
| 1 ON/STANDBY switch/indicator (8) | 0 P PAUSE button (19, 36) |
| 2 Tape compartment | ! j RF CHANNEL button (8) |
| 3 PROGRAM/TRACKING +/- buttons (8, 33) | !™ COLOR SYSTEM button (19) |
| 4 EJECT button (19) | ! £ TAPE SPEED button (23) |
| 5 REW button (19, 28) | ! φ INPUT SELECT button (24, 26) |
| 6 · PLAY button (19, 28) | ! LINE-2 IN AUDIO L/R/VIDEO jacks (35) |
| 7 FF #) button (19) | ! § COUNTER RESET button (20) |
| 8 r REC button (23) | ! ¶ Remote sensor (5) |
| 9 p STOP button (19, 23) | |

Display window

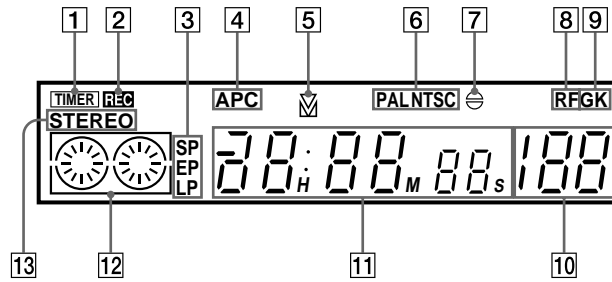

- | | | | |
|---|-------------------------------|-----|---|
| 1 | TIMER indicator (26) | 8 | RF indicator (8) |
| 2 | REC (Recording) indicator | 9 | TV system indicator (8) |
| 3 | Tape speed indicators (23) | 0 | Line/programme position indicator (8, 23) |
| 4 | APC indicator (33) | ! | Time counter/clock (20) |
| 5 | Tracking indicator (33) | !™ | Tape indicator |
| 6 | Colour system indicators (19) | ! £ | STEREO indicator (SLV-X817 only) (32) |
| 7 | Audio dubbing indicator (37) | | |

Rear panel

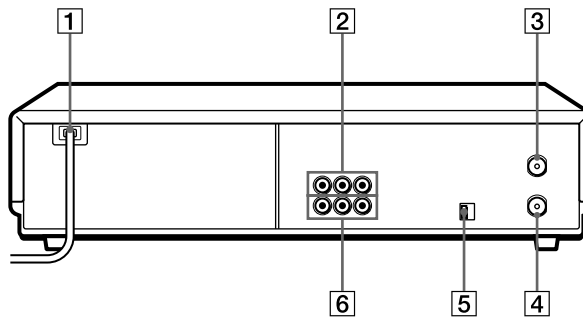

- | | | | |
|---|--|---|--|
| 1 | Mains lead (6) | 4 | AERIAL OUT connector (6) |
| 2 | LINE-1 IN AUDIO L/R/VIDEO jacks (SLV-X817 only) (35) | 5 | NTSC PB switch (20) |
| | LINE-1 IN AUDIO/VIDEO jacks (SLV-X717 only) (35) | 6 | LINE OUT AUDIO L/R/VIDEO jacks (SLV-X817 only) (7) |
| 3 | AERIAL IN connector (6) | | LINE OUT AUDIO/VIDEO jacks (SLV-X717 only) (7) |

continued

Index to parts and controls (continued)

Remote commander

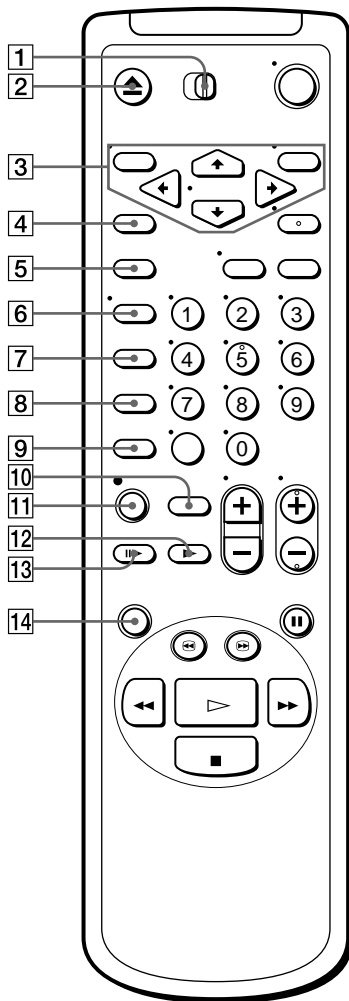

- 1 **TV/VIDEO** remote control switch (5)
- 2 **EJECT** button (19)
- 3 **Menu operation buttons** (10)
MENU button
CURSOR >/./?// buttons
EXECUTE button
- 4 **AUDIO DUB** button (37)
- 5 **TRINITRON TV SYNCHRO PLAY** button (21)
- 6 **DISPLAY** button (20, 23)
- 7 **COUNTER RESET** button (20)
- 8 **TIMER CLEAR** button (31)
- 9 **QUICK TIMER** button (30)
- ! ° **TAPE SPEED** button (23)
- ! j r **REC** button (23)
- !™ & **SLOW** button (28)
- ! £ 7 **FRAME** button (28)
- ! ∅ **REPLAY** button (19)

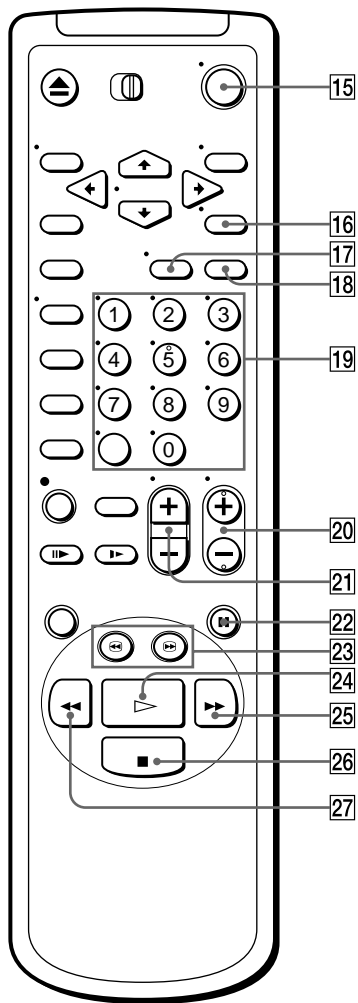

- ! u (on/standby) switch (8, 26)
- ! § AUDIO MONITOR button (32)
(This button doesn't work for SLV-X717)
- ! ¶ TV/VIDEO button (for TV) (5)
- ! • INPUT SELECT button (24, 26)
- ! ^a Programme number/? (ten's digit) buttons (24)
- @^o PROG +/- buttons (16, 23)
- @_i VOL +/- buttons (for TV)
- @^M P PAUSE button (19)
- @_{3/#} SEARCH buttons (19, 28)
- @_· PLAY button (19)
- @₎ FF button (19, 28)
- @_p STOP button (19, 23)
- @₀ REW button (19, 28)

Index

A, B

- Accessories supplied 4
- Adjusting
 - picture 17, 29, 33
 - tracking 29, 33
- Aerial hookup 6
- AFT (Auto Fine Tuning) 17
- APC (Adaptive Picture Control) 33
- Audio dubbing 37
- AV connection 7

C

- Cancelling timer settings 31
- Changing timer settings 31
- Cleaning the video heads 38
- Clock setting 11
- Colour system
 - compatible colour systems 2
 - setting 19
- Connecting
 - the VCR and your TV 6
 - to a TV with audio/video jacks 7
- Counter 20

D

- Disabling programme position 17
- Dubbing. See Editing

E, F, G

- Editing 35
- EP mode 24, 27, 36

H, I, J, K

- Hi-fi audio track 32

L

- Language selection 10
- LP mode 23

M

- Monitoring during playback 32

N, O

- Normal audio track 32
- NTSC-recorded tapes 20

P

- Picture adjustment. See Adjusting
- Playback 18
 - at various speeds 28
 - frame-by-frame 28
 - slow motion 28
- Presetting channels 13

Q

- Quick timer 30

R

- Recording 22
 - saving 24
 - while watching another programme 23
- Remote commander 5

S

- Safety tab 24
- Searching at various speeds 28
- SP mode 23

T, U, V, W, X, Y, Z

- Timer recording 25
 - cancelling timer settings 31
 - changing timer settings 31
 - checking timer settings 31
 - daily/weekly recording 27
 - overlapping timer recordings 31
- Tracking adjustment. See Adjusting
- Trinitron TV synchro play 21
- Tuning the VCR 13
- Tuning your TV to the VCR 8
- TV system 8