

SONY[®]

3-859-191-11 (1)

VIDEO CD Player

Operating Instructions	EN
MMMMM	C1
MMMMM	C2



MCE-K700

© 1996 by Sony Corporation

Actual page number:

Actual page number:

WARNING

To prevent fire or shock hazard, do not expose the unit to rain or moisture. To avoid electrical shock, do not open the cabinet. Refer servicing to qualified personnel only.

Laser component in this product is capable of emitting radiation exceeding the limit for Class 1.

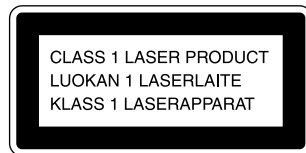

This appliance is classified as a CLASS 1 LASER product. The CLASS 1 LASER PRODUCT MARKING is located on the rear exterior.

The following caution label is located inside of the unit.

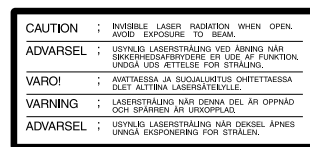

Precautions

On safety

- Caution – The use of optical instruments with this product will increase eye hazard.
- Should any solid object or liquid fall into the cabinet, unplug the player and have it checked by qualified personnel before operating it any further.

On power sources

- Before operating the player, check that the operating voltage of the player is identical with your local power supply. The operating voltage is indicated on the nameplate at the rear of the player.
- The player is not disconnected from the AC power source (mains) as long as it is connected to the wall outlet, even if the player itself has been turned off.
- If you are not going to use the player for a long time, be sure to disconnect the player from the wall outlet. To disconnect the AC power cord (mains lead), grasp the plug itself; never pull the cord.
- Should the AC power cord (mains lead) need to be changed, have it done at a qualified service shop only.

On placement

- Place the player in a location with adequate ventilation to prevent heat build-up in the player.
- Do not place the player on a soft surface such as a rug that might block the ventilation holes on the bottom.
- Do not place the player in a location near heat sources, or in a place subject to direct sunlight, excessive dust or mechanical shock.

On operation

- If the player is brought directly from a cold to a warm location, or is placed in a very damp room, moisture may condense on the lenses inside the player. Should this occur, the player may not operate properly. In this case, remove the disc and leave the player turned on for about an hour until the moisture evaporates.

On adjusting volume

- Do not turn up the volume while listening to a portion with very low level inputs or no audio signals. If you do, the speakers may be damaged when a peak level portion is played.

On cleaning

- Clean the cabinet, panel and controls with a soft cloth slightly moistened with a mild detergent solution. Do not use any type of abrasive pad, scouring powder or solvent such as alcohol or benzene.

If you have any questions or problems concerning your player, please consult your nearest Sony dealer.

Welcome!

Thank you for purchasing the Sony Video Compact Disc (VIDEO CD) Player. Before operating the unit, please read this manual thoroughly and retain it for future reference.

About This Manual

The instructions in this manual are for model MCE-K700.

Conventions

- Instructions in this manual describe the controls on the player. You can also use the controls on the remote if they have the same or similar names as those on the player.
- The following icons are used in this manual:



Indicates that you can use only the remote to do the task.





Indicates tips and hints for making the task easier.

TABLE OF CONTENTS

This Player Can Play the Following Discs	4
<hr/>	
Getting Started	
Unpacking	4
Hooking Up the System	5
<hr/>	
Basic Operations	
Playing a VIDEO CD	8
<hr/>	
Enjoying Karaoke	
Playing Karaoke	10
<hr/>	
Locating a Scene or Track You Want	
Using the On-Screen Display	12
Using the Front Panel Display	13
Resuming Playback from the Point You Stopped a VIDEO CD (Resume Play)	14
Locating a Specific Track	15
Locating a Particular Point in a Scene or Track	16
Locating by Observing Several Scenes at One Time (Digest Play)	17
<hr/>	
Playing CDs in Various Modes	
Playing Repeatedly	19
Playing in Random Order (Shuffle Play)	20
Creating Your Own Program (Program Play)	20
Reducing Distortion of the Picture (DNR)	22
Adding an Incidental Image to Moving Pictures (COMET)	22
Enjoying Sound Effects (Surround Sound)	23
Controlling the TV with the Supplied Remote	23
<hr/>	
Enjoying Karaoke Using the Various Effects	
Adding richness to your voice (Karaoke Star)	24
Adjusting the Balance of the Accompaniment and the Vocals	24
Playing Karaoke with Any Stereo Discs (Karaoke Pon)	25
Playing Karaoke with Your Video Equipment	25
<hr/>	
Enjoying Playback Using the PBC Functions	
Playing VIDEO CDs with PBC Functions (PBC Playback)	26
Locating Scenes Directly Using the Scene Numbers (Scene Search)	27
<hr/>	
Additional Information	
Notes on Discs	29
Troubleshooting	29
Specifications	30
Glossary	30
<hr/>	
Index	32

This Player Can Play the Following Discs

	VIDEO CDs	Audio CDs
Disc logo		
Contents	Audio + Video (moving pictures)	Audio
Disc size	12 cm/8 cm	12 cm/8 cm (CD single)
Play time	74 min./ 20 min.	74 min./ 20 min.

To play VIDEO CDs, see page 8.

To enjoy PBC Playback of VIDEO CDs with PBC functions, see page 26.

To play karaoke, see page 10.

Note on VIDEO CDs

This player conforms to Ver. 1.1 and Ver. 2.0 of VIDEO CD standards. You can enjoy two kinds of playback according to the disc type.

Disc type	You can
VIDEO CDs without PBC functions (Ver. 1.1 discs)	Enjoy video playback (moving pictures) as well as music.
VIDEO CDs with PBC functions (Ver. 2.0 discs)	Play interactive software using menu screens displayed on the TV screen (PBC Playback), in addition to the video playback functions of Ver 1.1 discs. Moreover, you can play high-resolution still pictures, if they are included on the disc.

Getting Started

Unpacking

Check that you received the following items:

- Audio and video connecting cord (3 phono plugs - 3 phono plugs) (1)
- Remote commander (remote) (1)
- Sony SUM-3 (NS) batteries (2)
- Plug adaptor (1)

Inserting batteries into the remote

You can control the player using the supplied remote. Insert two R6 (size AA) batteries by matching the + and - on the batteries. When using the remote, point it at the remote sensor  on the player.

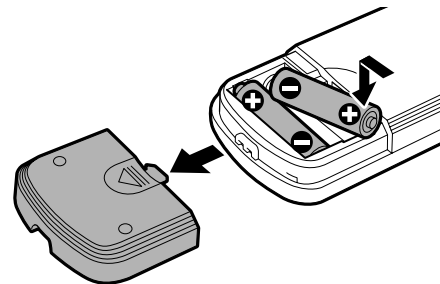

 You can control Sony TVs with the  mark using the supplied remote. See page 23.

 **When to replace batteries**
With normal use, the batteries should last for about six months. When the remote no longer operates the player, replace all the batteries with new ones.

Notes

- Do not leave the remote near an extremely hot or humid place.
- Do not drop any foreign object into the remote casing, particularly when replacing the batteries.
- Do not expose the remote sensor to direct sunlight or lighting apparatuses. Doing so may cause a malfunction.
- If you don't use the remote for an extended period of time, remove the batteries to avoid possible damage from battery leakage and corrosion.

Hooking Up the System

Overview

This section describes how to hook up the VIDEO CD player to a TV (with audio/video input jacks) and/or an amplifier. Be sure to turn off the power of each component before making the connections.

■ When listening to the sound through TV speakers

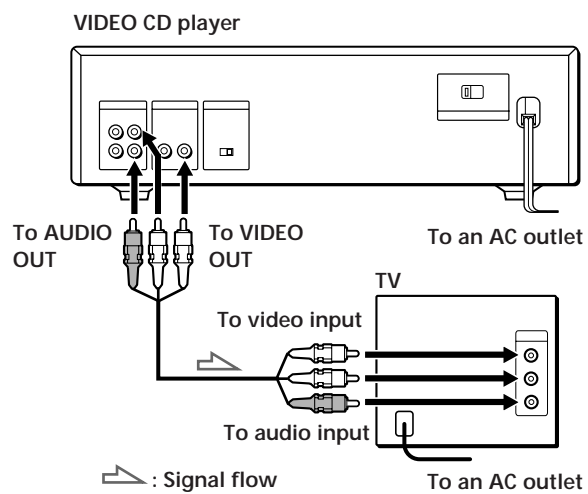

■ When listening to the sound through speakers connected to an amplifier

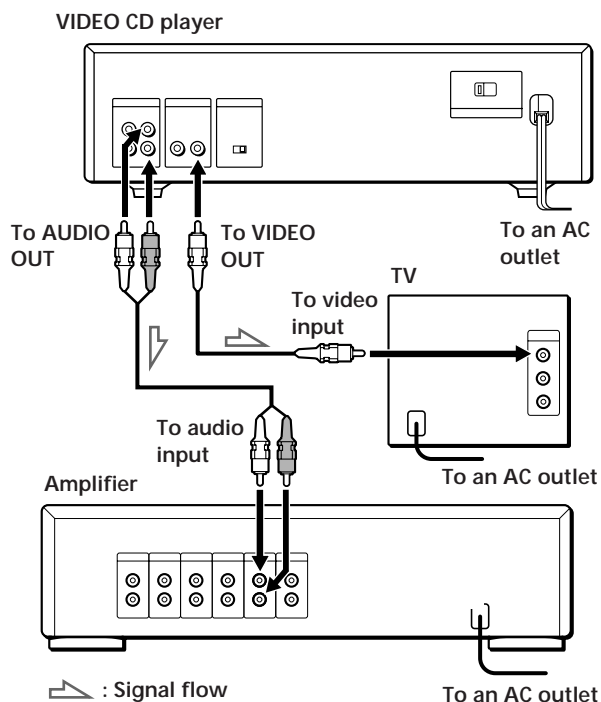

What cords will I need?

Audio and video connecting cord (supplied) (1)

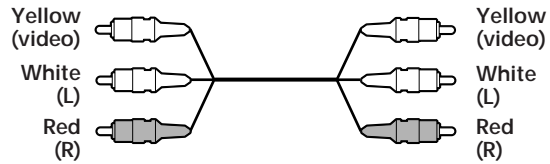

Video connecting cord (not supplied) (1)

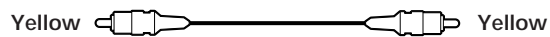

Audio connecting cord (not supplied) (1)

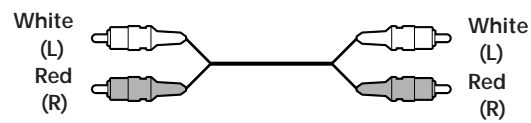

Hookups

When connecting the cord, be sure to match the color-coded cord to the appropriate jacks on the components: Yellow (video) to Yellow, Red (right) to Red and White (left) to White. Be sure to make connections firmly to avoid hum and noise.

■ When listening to the sound through TV speakers

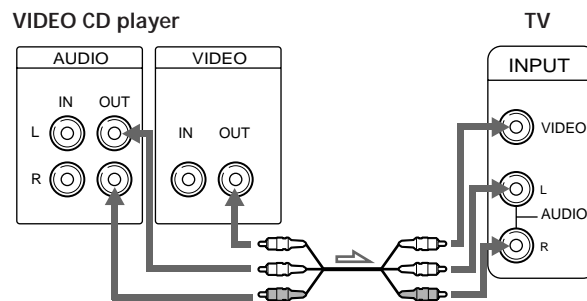

■ When listening to the sound through speakers connected to an amplifier

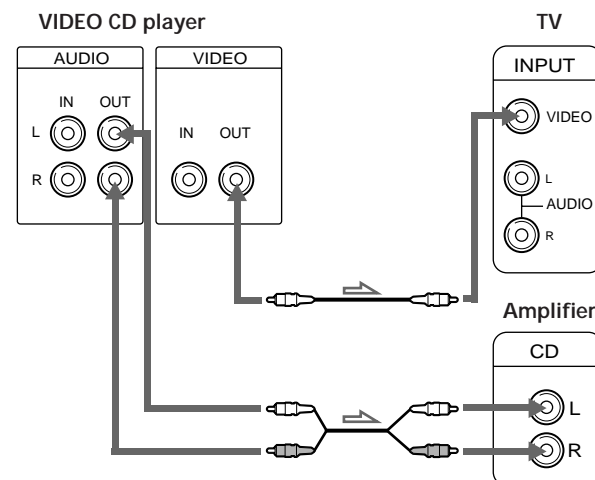

(Continued)

Getting Started

-  You can connect video equipment (a VCR, an LD player, etc.) to this player
Connect the video equipment to the AUDIO IN and VIDEO IN jacks of the player.
You can enjoy karaoke with your video equipment (see page 25) using the karaoke functions of the player.

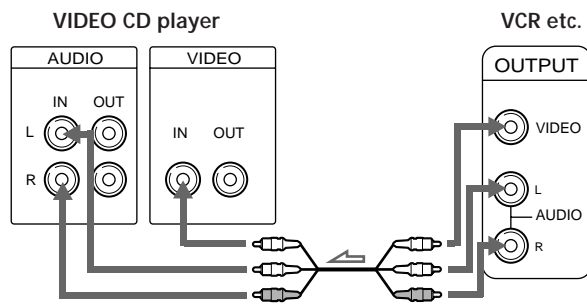

Important

Setting the color system switch

This player conforms to the NTSC and PAL color systems. Set the COLOR SYSTEM switch on the rear of the player to the appropriate position, according to your TV.

- If the color system of your TV is NTSC:
Set the COLOR SYSTEM switch to NTSC. Pictures will not be displayed if you set the switch to PAL. When you play a VIDEO CD recorded in the PAL color system, the picture will be stretched vertically and will be displayed with the upper and lower parts of the picture cut off.
- If the color system of your TV is PAL:
Set the COLOR SYSTEM switch to PAL. Pictures will not be displayed if you set the switch to NTSC. When you play a VIDEO CD recorded in the NTSC color system, the picture will be stretched horizontally and will be displayed with the upper and lower parts of the screen masked in black.
- If your TV automatically changes the color system according to the input signal:
Pictures will be displayed with the switch set to either NTSC or PAL.
If you set the COLOR SYSTEM switch to AUTO, the player automatically changes the color system of video output according to the color system of the VIDEO CD to be played. In this case, the color system selected remains until you turn off the player, or you play another VIDEO CD with a different color system. If you turn off the player, the color system will be set to NTSC automatically when you turn on the player again.
- If you connect the video equipment to this player:
Set the COLOR SYSTEM switch to NTSC or PAL according to your video equipment.
If you set the COLOR SYSTEM switch to AUTO, the on-screen display of the player may not be displayed properly depending on discs or tapes.

Be sure to turn off and on the player when you change the setting.

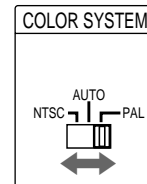

Setting the VOLTAGE SELECTOR

Check that the VOLTAGE SELECTOR on the rear panel of the player is set to the local power line voltage. If not, set the selector to the correct position using a screwdriver before connecting the AC power cord to a wall outlet.

When you set the selector to "110 - 120 V" position, be sure to use the supplied plug adaptor.

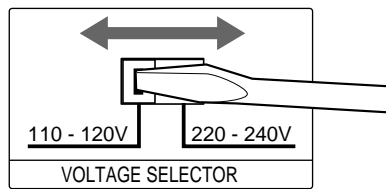

Connecting the AC power cord

Connect the AC power cord to a wall outlet.

Basic Operations

Playing a VIDEO CD

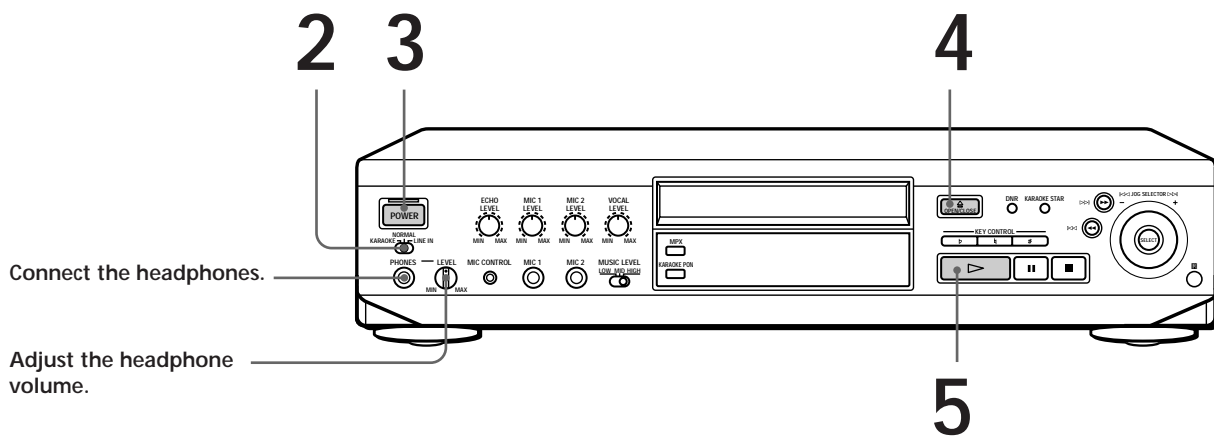

- See pages 5 – 7 for the hookup information.
- You can also play audio CDs just like VIDEO CDs.

You can turn on the player using the remote. Press POWER while the indicator above the POWER button on the front panel is lit.

When playing VIDEO CDs with PBC functions. In Step 5, the menu screen appears on the TV screen. You can play the VIDEO CD interactively, following the instructions on the menu screen. (PBC Playback, see page 26.)

What is a VIDEO CD with PBC functions? See page 26 or 30.

1 **When using a TV**
Turn on the TV and select the video input so that you can view the pictures from this player.

When using an amplifier
Turn on the amplifier and select the CD player position so that you can listen to the sound from this player.

2 Set the mode selector on the player to NORMAL.

3 Press POWER to turn on the player.
The indicator above the POWER button goes off and the front panel display lights up.

4 Press OPEN/CLOSE, and place the disc on the disc tray.

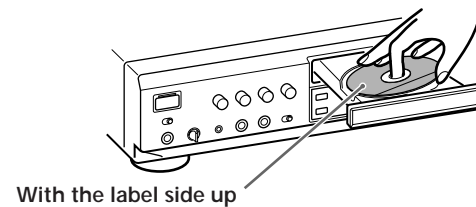

5 Press PLAY.
The disc tray closes and the player plays all the tracks once (Continuous Play). Adjust the volume on the TV or the amplifier.

Basic Operations

 When "RESUME" appears in the front panel display You can resume playback from the point you stopped the VIDEO CD (Resume Play, see page 14).

To stop playback

Press ■.

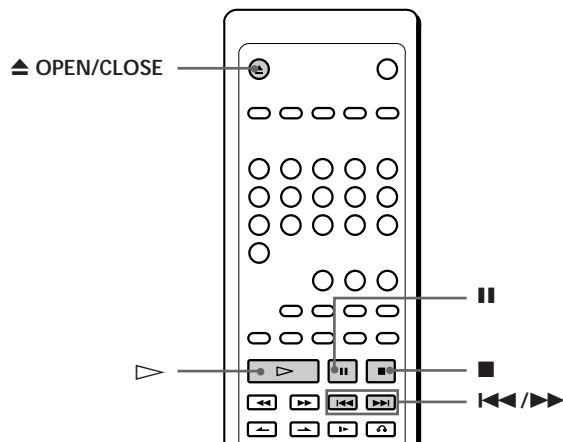
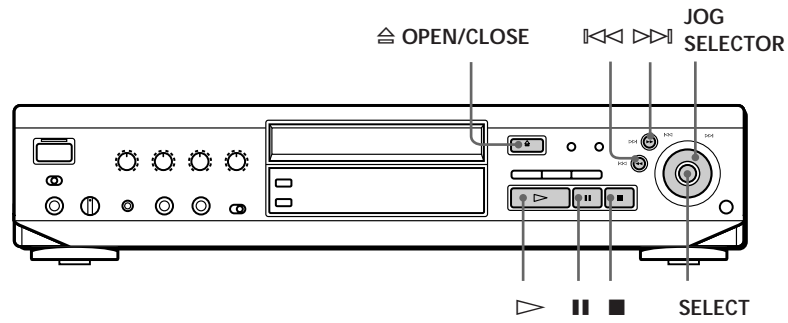

To	Press
Pause	
Resume play after pause	or ▷
Select the track (in Continuous Play mode)	Use JOG SELECTOR or ◀◀/▶▶ While playing: Turn JOG SELECTOR on the player until you find the track Go to the next track, press ▶▶ once Go back to the preceding track, press ◀◀ repeatedly Before you start playing: Turn JOG SELECTOR or press ◀◀/▶▶ repeatedly to select the track number, then press SELECT or ▷
Stop play and remove the CD	△ OPEN/CLOSE

 **What is a track?**
A disc is divided into sections of a picture or a music piece called "tracks." Each track is assigned with a track number to locate the track you want.

Playing Karaoke

You can play karaoke (singing along) with CDs. Be sure to set the on-screen display mode to ON SCREEN 1 or ON SCREEN 2 (see page 12). If you select ON SCREEN OFF display mode, no information is shown on the TV screen.

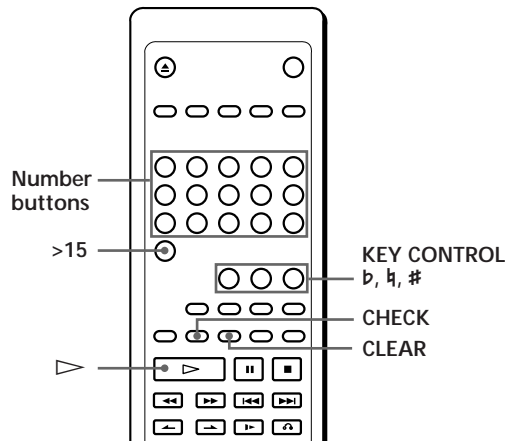
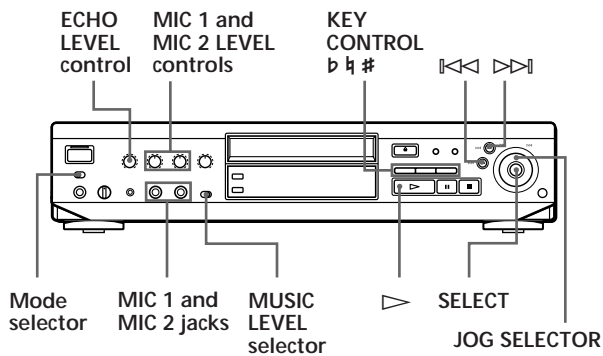

- 1 Set the MIC 1 and MIC 2 LEVEL controls on the player to MIN, then plug the microphone(s) into the MIC 1 and/or MIC 2 jacks.

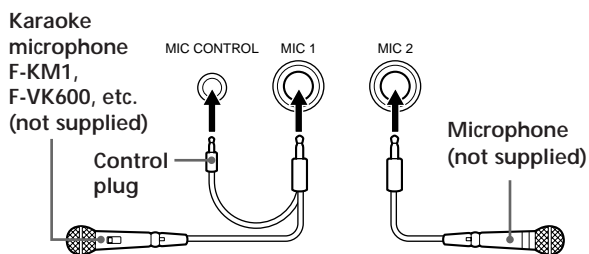

When using the karaoke microphone F-KM1, F-VK600, etc. (not supplied), plug the control plug into the MIC CONTROL jack.

- 2 Set the mode selector on the player to KARAOKE. "KARAOKE MODE" appears on the TV screen, then the following screen appears after about 2 seconds.

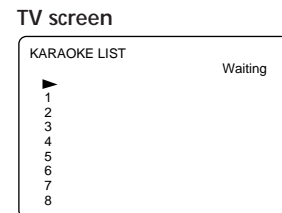

- 3 Select the track you want to play.

On the player

Turn JOG SELECTOR until the track number you want to play appears in the front panel display, then press SELECT.

On the remote

Press the number button of the track.

To select a track numbered over 15, use the >15 button (see page 15).

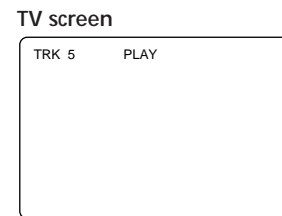

Example: when you select track 5

Play starts automatically.

- 4 Turn the MIC 1 and/or MIC 2 LEVEL control to adjust the microphone volume.

To stop playback

Press ■.

Notes

If howling occurs:

- Move the microphone(s) away from the TV or the speakers.
- Lower the volume of the TV or the amplifier.
- Lower the microphone volume or echo level.

If the sound is distorted when the player is connected to a TV:

- Lower the microphone volume and music level.



When you don't use the microphone(s)

Unplug the microphone(s), switch the microphone(s) off and turn the MIC 1 and/or MIC 2 LEVEL control to MIN.

Front panel display in Karaoke mode

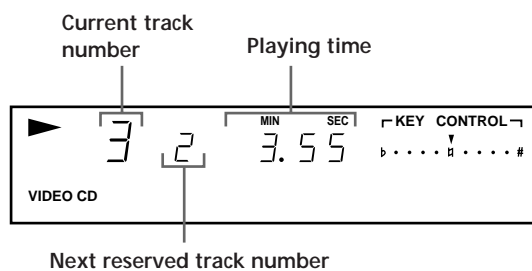

Reserving the next tracks to play

While playing a disc, you can reserve up to 8 tracks to play in any order so that you can enjoy non-stop karaoke play.

- 1 While playing a disc, select the track you want.

On the player

Turn JOG SELECTOR to select the track, then press SELECT.

On the remote

Press the number button of the track.

To select a track numbered over 15, use the >15 button (see page 15).

The track number, "RESERVED" and the playing order appear on the TV screen.

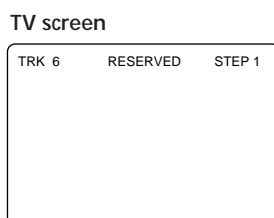

Example: when you select track 6

- 2 Repeat Step 1 to reserve up to 8 tracks. After reserving 8 tracks, you can reserve a new track when the current track is played to the end.

When you want to	Press
Play the current track again	⏮ (JOG SELECTOR does not function)
Go to the next specified track	⏭ (JOG SELECTOR does not function)
Check the track order	CHECK. The reservation list appears on the TV screen. You can also check the order one by one on the front panel display.
Cancel the reservation	CHECK repeatedly until the cursor (→) on the reservation list moves to the track you want to cancel or the track number you want cancel appears on the front panel display. Then press CLEAR.

Changing the key (Key Control)

You can change the key to suit your vocal range.

While playing karaoke, press one of the KEY CONTROL buttons repeatedly to find the key that suits your vocal range.

To	Press
Raise the key	#
Lower the key	b
Return to the original key	h

You can adjust the key to 11 steps (5 steps higher, 5 steps lower and the original key).

The setting appears in the front panel display and on the TV screen.



When the track ends

The key automatically returns to the original key.



When a karaoke microphone (F-KM1, F-VK600, etc.) is connected

You can change the key with KEY CONTROL #/b on the microphone.

Adjusting the echo level

You can give an echo effect to the sound from the microphones.

Turn the ECHO LEVEL control to adjust the strength of echo.

The same echo level is applied to both microphones connected to the MIC 1 and MIC 2 jacks.

Note

If you don't want any echo effect, set the ECHO LEVEL control to MIN.

Adjusting the music level

If you want to reduce the music level, set the MUSIC LEVEL selector to MID or LOW.

This has no effect on the settings of the MIC LEVEL controls.

Note

When playing a CD as a general CD, set the MUSIC LEVEL selector to HIGH.

Locating a Scene or Track You Want

Using the On-Screen Display

You can check the operating status of the player and the information about the disc with the on-screen display on the TV screen.

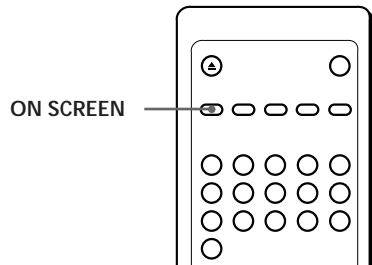

Press ON SCREEN.
Each time you press the button, the on-screen display changes as follows:

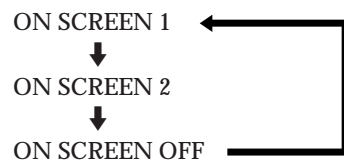

When Using a VIDEO CD

■ Display information of ON SCREEN 1 mode

The operating status is displayed for a few seconds only when you change the operating status.

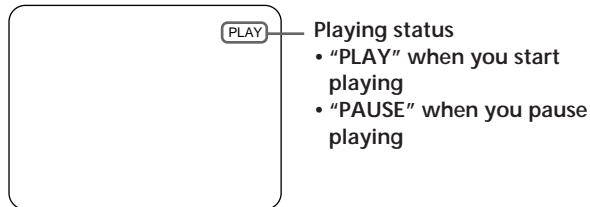

- Before you start playing (except for the Program Play mode)

Setting of the mode selector

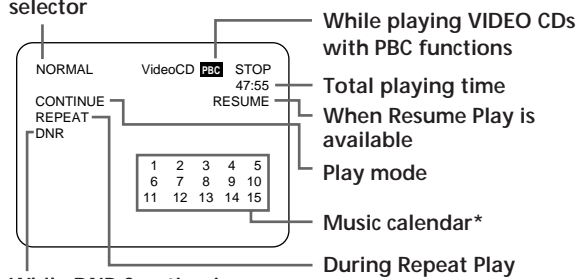

While DNR function is turned on ("COMET" is displayed when you select COMET.)

* The music calendar is not displayed during PBC Playback.

- Before you start playing in Program Play mode

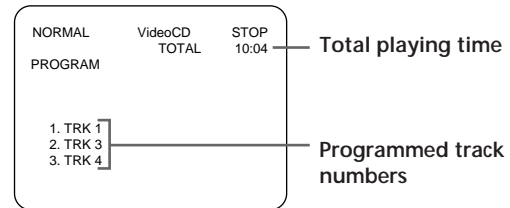

■ Display information of ON SCREEN 2 mode

While playing a disc, the current track number and the playing time are always displayed.
The operating status is displayed for a few seconds only when you change the operating status.
The same information as in ON SCREEN 1 is displayed before you start playing.

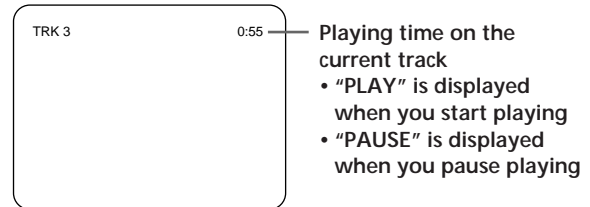

- During PBC Playback (page 26)

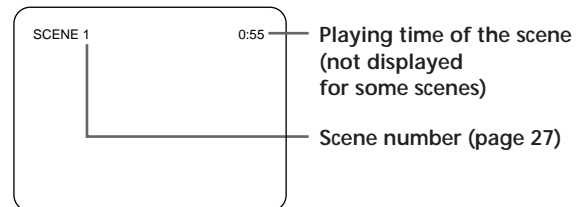

■ Display information of ON SCREEN OFF mode

No information is displayed.

When Using an Audio CD

The same information is displayed in ON SCREEN 1 mode and ON SCREEN 2 mode while playing an audio CD.

■ Display information of ON SCREEN 1 or ON SCREEN 2.

- In Continuous or Shuffle Play mode

Setting of the mode selector

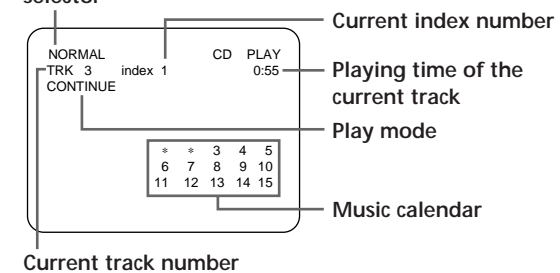

Locating a Scene or Track You Want

- In Program Play mode

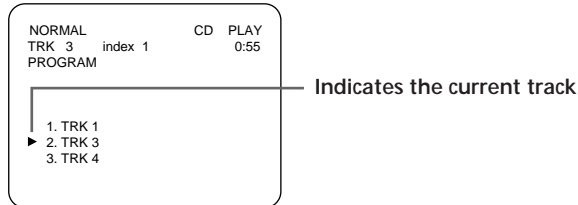

- Before you start playing (except for the Program Play mode)

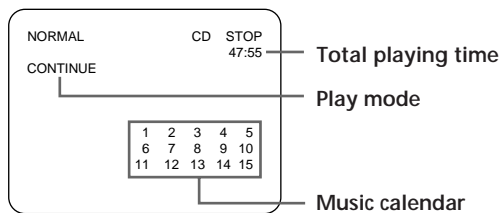

- Before you start playing in Program Play mode

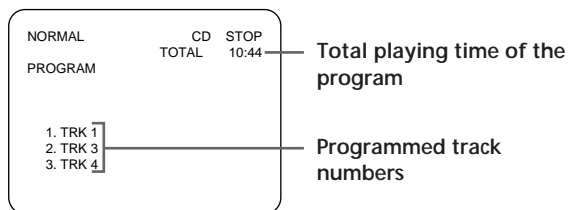

- Display information of ON SCREEN OFF mode
No information is displayed.

Notes

- Select the display mode other than ON SCREEN OFF for normal operation. When you select ON SCREEN OFF, you cannot check the operating status while operating the player. In this case, check the information in the front panel display.
- When you record the playback picture of this player on another VCR, etc., be sure to select ON SCREEN OFF. Otherwise, the display information is also recorded on the VCR.

Using the Front Panel Display

You can check information about the disc using the front panel display.

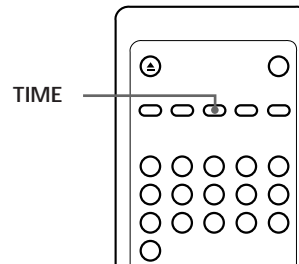

Checking the total number and playing time of the tracks

Press TIME before you start playing.
The front panel display shows the total number of tracks and total playing time.

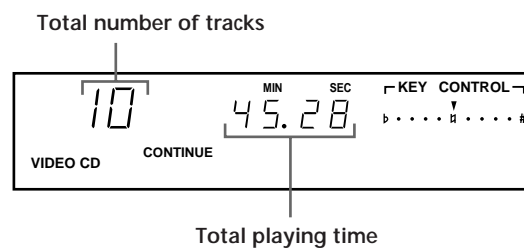

The information also appears when you press  OPEN/CLOSE to close the disc tray.

Display information while playing a disc

While playing an audio CD or a VIDEO CD without PBC functions, the front panel display shows the current track number, playing time of the track and index number (page 16).

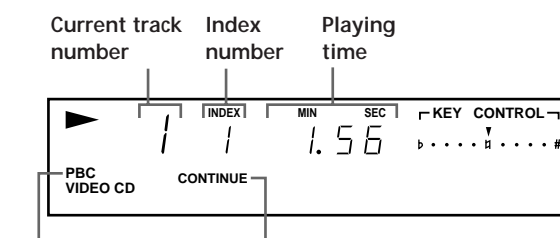

"PBC" is displayed while playing a VIDEO CD with PBC functions (page 26).

"CONTINUE" is displayed while playing a VIDEO CD without PBC functions or an audio CD.

(Continued)

Locating a Scene or Track You Want

Checking the remaining time

Each time you press TIME while playing a disc, the display changes as shown in the chart below. Note that you cannot check the remaining time during PBC Playback (page 26).

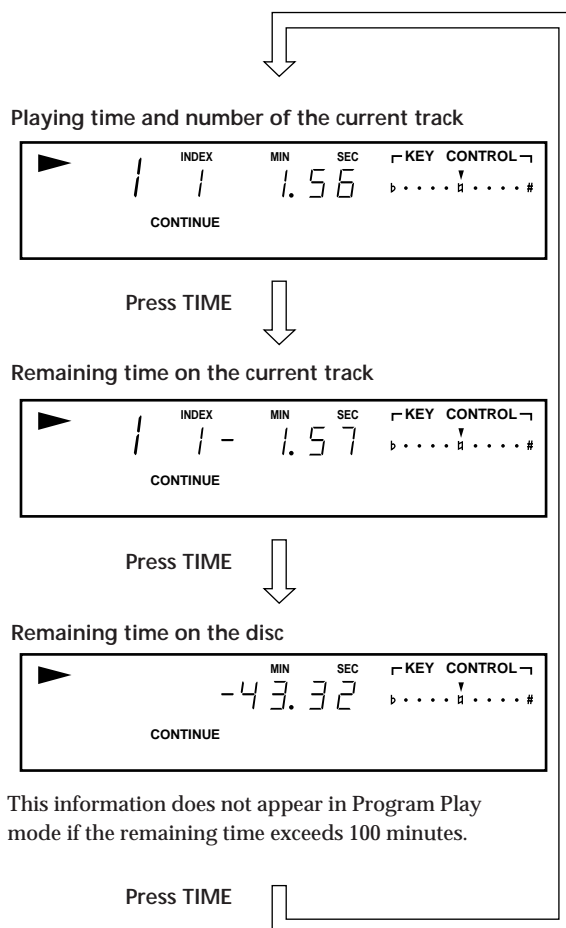

💡 What is a track?

A disc is divided into sections of a picture or a music piece called "tracks." Each track is assigned with a track number to locate the track you want.

Resuming Playback from the Point You Stopped a VIDEO CD (Resume Play)

This function is available only when the mode selector is set to NORMAL and the disc is played in Continuous Play mode or PBC Playback mode. The player memorizes the point you stopped a VIDEO CD and you can resume playback from that point. Resume Play is not cancelled whenever you turn off the player. Note that Resume Play is not available while playing an audio CD.

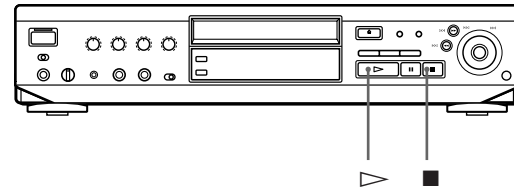

- 1 While playing a VIDEO CD, press ■ to stop playback. "RESUME" appears in the front panel display and on the TV screen. If "RESUME" doesn't appear, Resume Play is not available.

- 2 Press ▷. The player starts playback from the point you stopped the VIDEO CD in Step 1.

💡 To view from the beginning of the VIDEO CD
When "RESUME" appears in the front panel display, press ■, then press ▷.

Notes

- Depending on where you stopped the VIDEO CD, the player may resume playback from a different point.
- The point at which you stopped playing is cleared when :
 - you press number buttons, PLAY MODE or ■
 - you press ⏮/⏭
 - you turn JOG SELECTOR
 - you set the mode selector to KARAOKE or LINE IN
 - you remove the VIDEO CD from the player
 - you unplug the AC power cord of the player

Locating a Scene or Track You Want

Locating a Specific Track

You can quickly locate any track while playing a disc using the JOG SELECTOR, **⏮/⏭** buttons (AMS: Automatic Music Sensor) or number buttons.

Note that while playing a VIDEO CD with PBC functions, this function is available only during playback without PBC functions (PBC OFF, page 26).



What is a track?

A disc is divided into sections of a picture or a music piece called "tracks." Each track is assigned with a track number to locate the track you want.

Note

During PBC Playback, the JOG SELECTOR, **⏮** and **⏭** buttons have different functions from the ones explained in the left column.

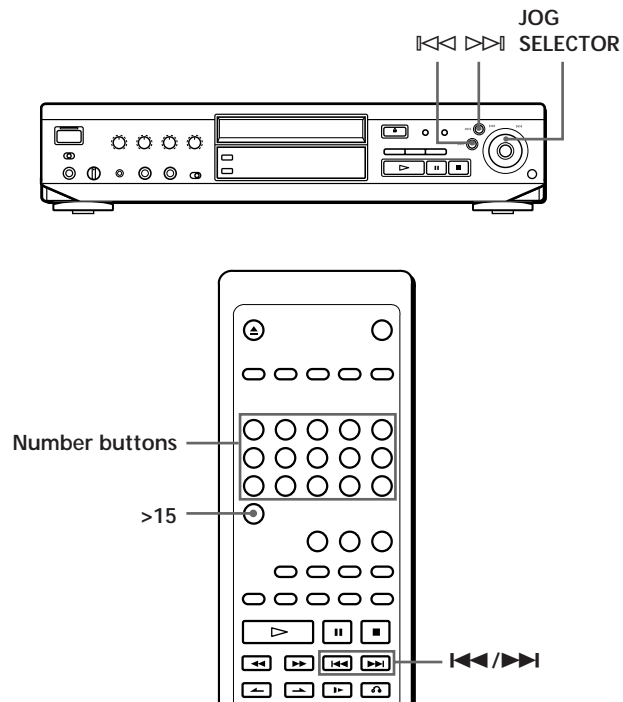

To locate	Press
The next or succeeding tracks (AMS)	⏭ repeatedly or turn JOG SELECTOR clockwise until you find the track
The current or preceding tracks (AMS)	⏮ repeatedly or turn JOG SELECTOR counterclockwise until you find the track
A specific track directly	Number button of the track



When you directly locate a track numbered over 15

Press >15 first, then the corresponding number buttons.

To enter "0," use button 10.

Example: To play track number 30

Press >15 first, then 3 and 10.

Locating a Scene or Track You Want

Locating a Particular Point in a Scene or Track

You can also locate a particular point in a scene or track while playing a disc.
 During PBC Playback (page 26), this function is available only while playing moving pictures.
 While playing an audio CD, Slow-motion Play is not available.

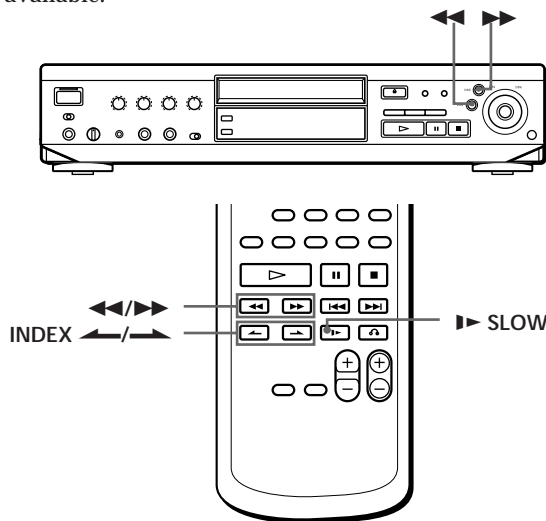

To locate a point	Press
While monitoring the picture or sound	▶▶ (forward) or ◀◀ (backward) and hold down until you find the point. You will not hear the sound while playing a VIDEO CD.
Slowly by observing the TV screen (Slow-motion Play)	▶▶ SLOW. You will not hear the sound during the operation. When you find the point, press ▷ to return to the normal speed.
Quickly by observing the front panel display during pause	◀◀/▶▶ and hold down until you find the point. You will not hear the sound during the operation.

💡 If you want to locate a particular point of a long track
 It is convenient to use Track Digest (see page 18).

💡 If "⏮" appears in the front panel display
 The disc has reached the end while you were pressing ▶▶. Press ◀◀ or ◀◀◀ to go back.

💡 If you want to change the playback speed during Slow-motion Play

Press ▶▶ SLOW repeatedly until you find the playback speed you want. Three speeds are available: SLOW 1 (1/5th the normal speed), SLOW 2 (1/10th) and SLOW 3 (1/15th). Each time you press the button, the indication changes as follows.



Note
 While playing a VIDEO CD, the picture may be distorted during the search operation.

Locating a point using the index (Index Search)

There are two kinds of indexes: one is for audio CDs and the other is for VIDEO CDs. You can locate a point you want using the index.

Note that this function is available only for indexed discs. Also note that you cannot search indexes in different tracks.

While playing a track, press INDEX ◀ or ▶ repeatedly.

- To locate the current or preceding index numbers, press INDEX ◀.
- To locate the next or subsequent index numbers, press INDEX ▶.

Front panel display

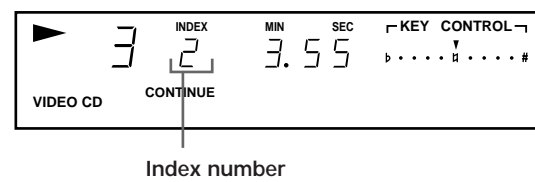

TV screen (while playing a VIDEO CD)
 ON SCREEN 1 or 2 display mode

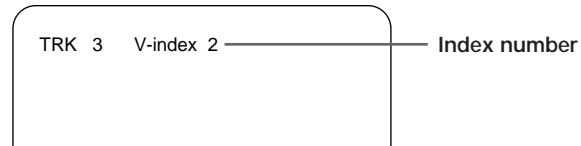

TV screen (while playing an audio CD)
 ON SCREEN 1 or 2 display mode

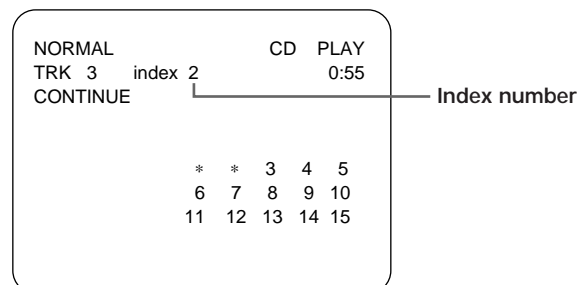

💡 **What is an index?**
 It is a number that divides a track or a disc into some sections in order to easily locate the point you want. You may determine if a disc uses index by looking at the disc's packaging.

Note
 If there are no more indexes while playing a VIDEO CD, "🚫 CANNOT OPERATE NOW" appears on the TV screen and the player continues playing.

Locating a Scene or Track You Want

Locating by Observing Several Scenes at One Time (Digest Play)

This function is available only when the mode selector is set to NORMAL.

You can locate the track or scene you want by observing several still pictures at one time on the TV screen.

Note that while playing a VIDEO CD with PBC functions, this function is available before you start playing or during playback without PBC functions (PBC OFF, page 26).

While playing a VIDEO CD, you will not hear the sound.

While playing an audio CD, you will only hear the sound.

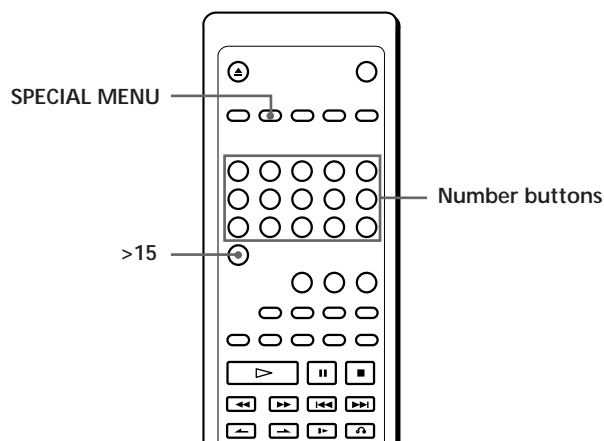

- Press button 2.
The TV screen shows still pictures of the first scenes of tracks 1 to 9 on the disc.

TV screen

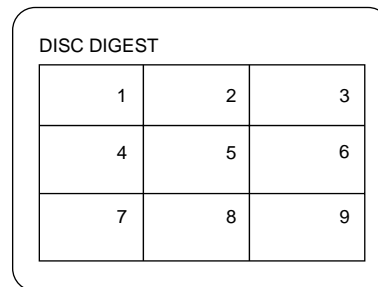

To view still pictures of the tracks numbered over 9
Press **▶▶▶**. The TV screen shows still pictures of tracks 10 to 18.

If there are more tracks, "**▶▶▶**" is displayed on the upper right side of the TV screen.

To go back to the previous screen, press **◀◀◀**.

- Press the number button to select the track.
The player starts playing from the selected track.
To select tracks numbered over 15
Use the >15 button (see page 15).

To cancel Disc Digest
Press **■**.

 While the still pictures are displayed in Step 2, you can start playing the track you want right away before all the still pictures are displayed
Press **▶** when the picture of the track you want appears on the TV screen.

Locating the track you want on a disc (Disc Digest)

You can locate the track you want by observing the first picture of up to 9 tracks on the disc at one time on the TV screen.

- Press SPECIAL MENU while playing a disc or before you start playing.
The following menu appears on the TV screen.

TV screen

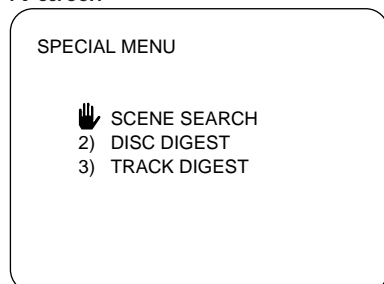

(Continued)

Locating a Scene or Track You Want

Locating the point you want in a track (Track Digest)

You can have the player divide a track into 9 sections. You can locate the point you want by viewing the first picture of each section at one time on the TV screen. This might be useful when you play a disc which is divided into few tracks, such as a movie.

- 1 Press **SPECIAL MENU** while playing a disc or before you start playing.
The following menu appears on the TV screen.

TV screen

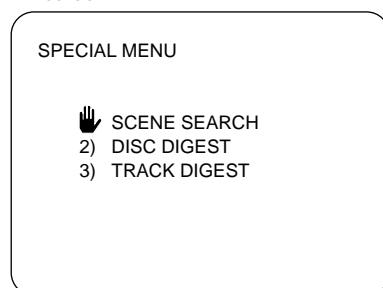

- 2 Press button 3.
The player divides the track into 9 sections and the TV screen shows still pictures of each section in order.

TV screen

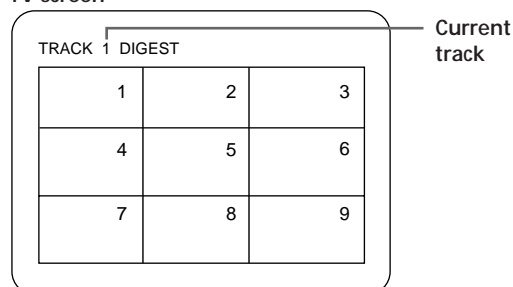

- 3 Press the number button (1 – 9) to select the point you want.
The player starts playing from the selected point. The player may start playing from a point which is a little different from the one displayed during Track Digest.

To cancel Track Digest
Press ■.

You can select a point which isn't displayed yet on the TV screen in Step 2

During Track Digest, you can start Track Digest on another track
Press ◀◀ or ▶▶.
Note that this function is not available in Shuffle or Program Play mode.

Notes

- If you start Track Digest before you start playing a VIDEO CD with PBC functions, the player automatically starts playing without PBC functions (PBC OFF, page 26).
- If you start Track Digest before you start playing in Shuffle or Program Play mode, the player automatically enters Continuous Play mode (page 8).
- When a track is shorter than about 40 seconds, the player may divide the track into less than 9 sections.

Playing CDs in Various Modes

Playing Repeatedly

You can play all the tracks, a single track or a specific portion repeatedly.

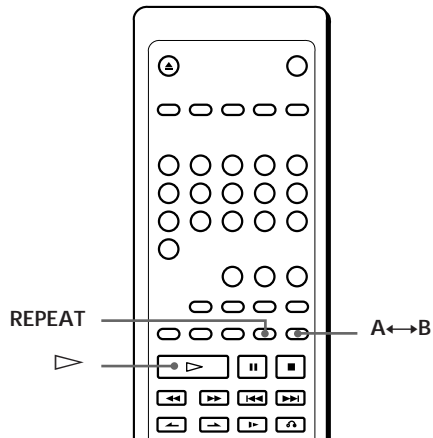

Repeating all the tracks on a disc

In Shuffle or Program Play mode, the player repeats the track in the shuffled or programmed order. You cannot do Repeat Play during PBC playback (page 26) or Digest Play (page 17).

Press REPEAT while playing a disc. "REPEAT" appears in the front panel display. The player repeats the tracks as follows:

When the disc is played in	The player repeats
Continuous Play (page 8)	All the tracks
Shuffle Play (page 20)	All the tracks in random order
Program Play (page 20)	The same program

To cancel Repeat Play

Press REPEAT repeatedly until "REPEAT" disappears from the front panel display.

Repeating the current track

You can repeat only the current track in Continuous Play mode (page 8).

While the track you want is being played, press REPEAT repeatedly until "REPEAT 1" appears in the front panel display.

To cancel repeating the current track

Press REPEAT repeatedly until "REPEAT 1" disappears from the front panel display.

Repeating a specific portion (A↔B→Repeat)

You can play a specific portion in a track repeatedly. This might be useful when you want to memorize lyrics.

During PBC Playback (page 26), this function is available only while playing moving pictures.

- 1 While playing a disc, press A↔B when you find the starting point (point A) to be played repeatedly. "A-" or "REPEAT A-" flashes in the front panel display.
- 2 When you reach the ending point (point B), press A↔B again. "REPEAT A-B" appears. The player plays this specific portion repeatedly.

To cancel A↔B→Repeat

Press REPEAT.

-  When you want to restart from the starting point A Press ▷ during A↔B Repeat.

Note

During A↔B Repeat, Slow-motion Play is not available.

Playing CDs in Various Modes

Playing in Random Order (Shuffle Play)

You can have the player “shuffle” tracks and play in a random order.

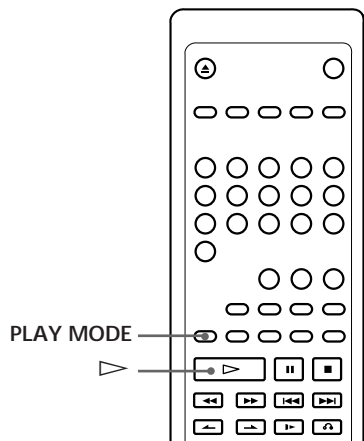

- 1 Press PLAY MODE repeatedly until “SHUFFLE” appears in the front panel display.

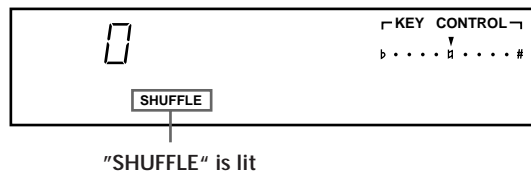

- 2 Press  to start Shuffle Play. The  indication appears while the player is “shuffling” the tracks.

To cancel Shuffle Play

Press PLAY MODE repeatedly until “CONTINUE” appears in the front panel display. (When playing a VIDEO CD with PBC functions, press PLAY MODE repeatedly until “SHUFFLE” disappears from the front panel display.)

-  You can start Shuffle Play while playing in Continuous Play mode. Press PLAY MODE repeatedly until “SHUFFLE” appears in the front panel display. Shuffle Play starts from the current track.

Note

If you play a VIDEO CD with PBC functions in Shuffle Play mode, you cannot use the PBC functions.

Creating Your Own Program (Program Play)

You can arrange the order of the tracks on the discs and create your own program. The program can contain up to 24 tracks.

If you set the mode selector to KARAOKE or LINE IN, the program is cleared.

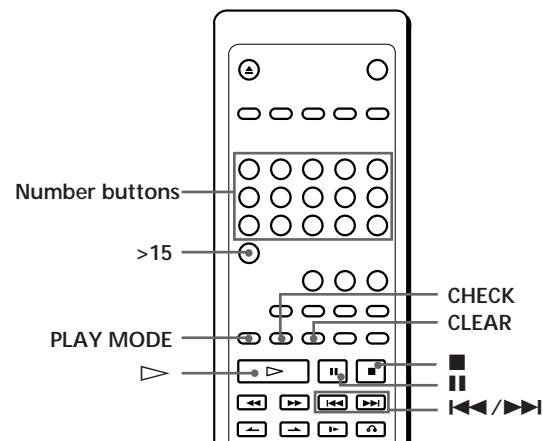
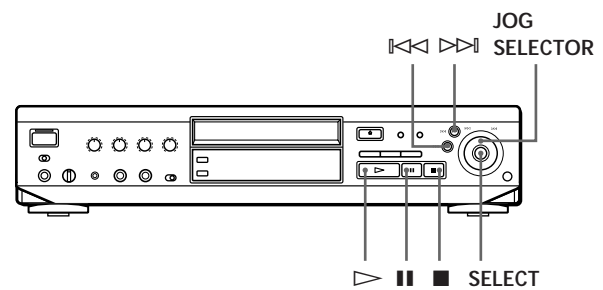

- 1 Press PLAY MODE repeatedly until “PROGRAM” appears in the front panel display. 

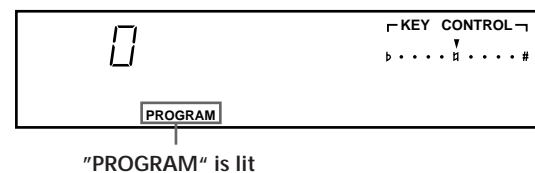

Playing CDs in Various Modes

2 Select the tracks you want to program.

On the player

Turn JOG SELECTOR until the track number you want to program appears in the front panel display, then press SELECT.

On the remote

Press the number buttons of the tracks you want to program in the order you want.

Example: To program the tracks in the order 2, 8, 5

Press the number buttons 2 → 8 → 5.

To program a track numbered over 15, use the >15 button (see page 15).

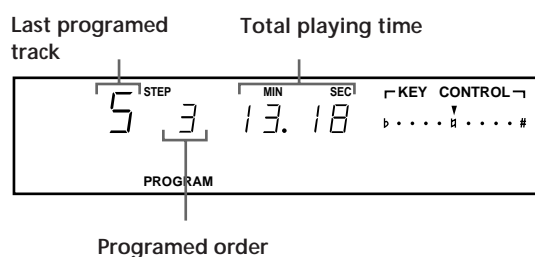

If you've made a mistake

Press CLEAR, then press the correct number button.

3 Press ▷ to start Program Play.

To cancel Program Play

Press PLAY MODE repeatedly until "CONTINUE" appears in the front panel display. (When playing a VIDEO CD with PBC functions, press PLAY MODE repeatedly until "PROGRAM" disappears from the front panel display.)

You can check the total playing time while programming in Step 2 (Program Edit)

1 Turn JOG SELECTOR or press ◀◀ or ▶▶ until the track you want to program appears in the front panel display.

The total playing time including the selected track appears in the front panel display.

2 Press SELECT or PLAY MODE to confirm your selection.

3 Repeat Steps 1 and 2 to program more tracks.

You can insert a pause as one step

During programming, press ■ to insert a pause. The total playing time is reset to "0.00."

When playing a program which contains a pause, the player pauses at the step in which a pause is programmed, until you press ■ or ▷. This might be useful when you record a program on both sides of a tape.

You can check the contents of the program during programming on the TV screen

If you press ON SCREEN to select ON SCREEN OFF display mode, you won't see this information (page 12).

The program remains even after the Program Play ends

When you press ▷, you can play the same program again.

Notes

- If you play a VIDEO CD with PBC functions in Program Play mode, you cannot use PBC functions (page 26).
- If the total playing time exceeds 100 minutes, "----" appears in the front panel display.
- If you program more than 24 tracks, "FULL" appears in the front panel display and on the TV screen.

Checking the track order

You can check your program before or after you start playing.

Press CHECK.

Each time you press this button, the front panel display shows the track number and the total playing time in the programmed order. After the last track in the program, the front panel display shows "End" and returns to the original display.

Changing the track order

You can change your program before you start playing.

To	Press
Erase a track	CHECK until the track you don't want appears in the display, then press CLEAR.
Erase the last track in the program	CLEAR. Each time you press this button, the last track is cleared.
Add tracks to the end of the program	Turn JOG SELECTOR then press SELECT on the player, or press number buttons of the tracks to be added on the remote.
Change the whole program completely	■ (stop). Create a new program following the programming procedure.

Playing CDs in Various Modes

Reducing Distortion of the Picture (DNR: Digital Noise Reduction)

You can make picture clearly by reducing distortion of the picture.

When you connect the AC power cord of the player to a wall outlet, the DNR function is automatically turned on.

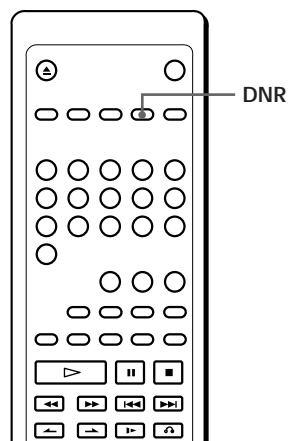
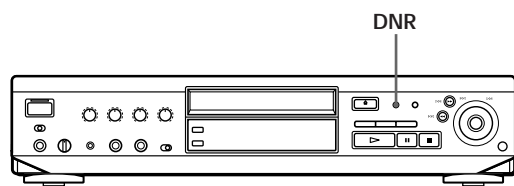

To cancel the DNR function

Press DNR to go off the DNR button indicator on the player. "DNR" disappears from the front panel display.

To turn on the DNR function again

Press DNR to light up the DNR button indicator. "DNR" appears in the front panel display.

Notes

- If you press COMET, DNR will be automatically canceled.
- The DNR function cannot reduce the outline noise of the picture or block noise on the picture.
- The effect of the DNR function may not be noticeable with the disc which contains low level noise.
- The DNR function does not work when the mode selector is set to LINE IN.

Adding an Incidental Image to Moving Pictures (COMET)

You can enjoy the picture which leaves an incidental image, such as a trail of comet. The COMET function gives an atmosphere to the picture.

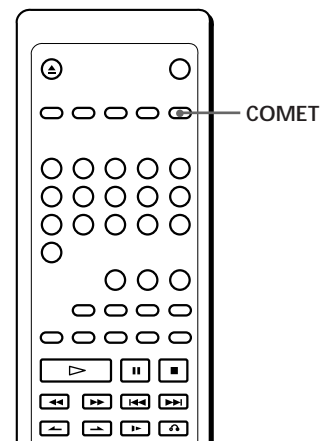

Press COMET. "COMET" appears in the front panel display.

To cancel the COMET function

Press COMET again. "COMET" disappears from the front panel display.

Notes

- If you press DNR, COMET will be automatically canceled.
- The COMET function does not work when the mode selector is set to LINE IN.

Playing CDs in Various Modes

Enjoying Sound Effects (Surround Sound)

You can play a disc with one of three acoustic atmospheres: KARAOKE, MUSIC or THEATER.

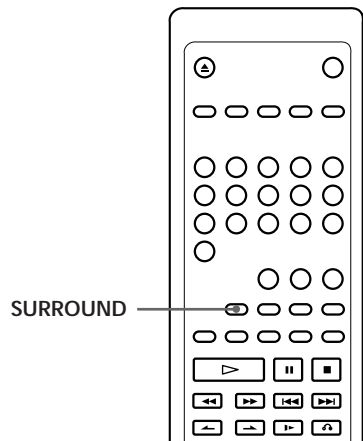

While playing a disc, press SURROUND repeatedly until the desired effect appears in the front panel display.

Effect mode	Atmosphere
KARAOKE	Creates the effect of singing in a bar. Gives your song a rich carrying tone.
MUSIC	Suitable for listening to the music.
THEATER	Simulates the resonance of a movie theater. Emphasizes the bass and extends the dynamic mid range.

To cancel the sound effect

Press SURROUND repeatedly until "KARAOKE", "MUSIC" and "THEATER" disappear from the front panel display.

Note

If you press MPX (see page 24), the surround sound mode is automatically set to KARAOKE.

Controlling the TV with the Supplied Remote

You can control Sony TVs with the  mark using the supplied remote.

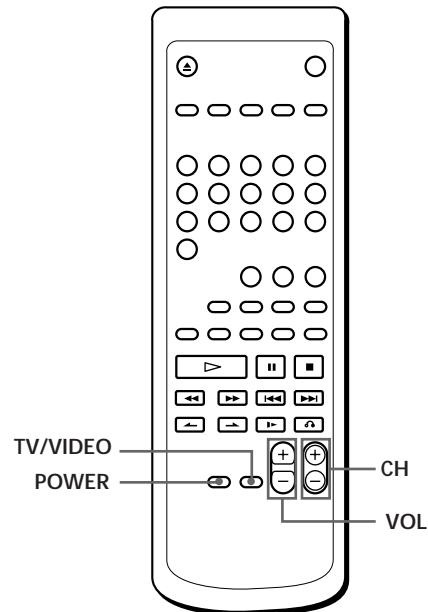

Press	You can
POWER	Turn on or off the TV
TV/VIDEO	Select the input source to the TV
VOL	Adjust the volume of the TV
CH	Change the channel of the TV

Adding richness to your voice (Karaoke Star)

Adjusting the Balance of the Accompaniment and the Vocals

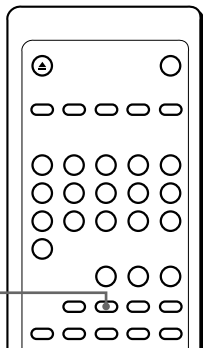
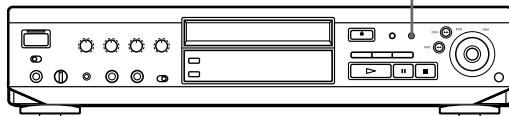

KARAOKE STAR

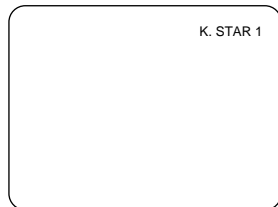

To cancel Karaoke Star
Press KARAOKE STAR so that the KARAOKE STAR button indicator goes off.

- Notes**
- When you use KARAOKE STAR, the ECHO LEVEL control should be set to the appropriate level.
 - In stop mode, "K. STAR OFF" does not appear on the TV screen even when you press KARAOKE STAR.
 - When you select ON SCREEN OFF display mode, no information is shown on the TV screen.

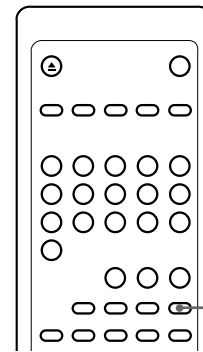
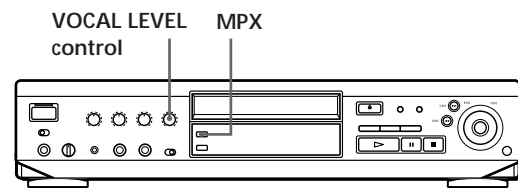

MPX

- 1 Press MPX while playing a multiplex disc. "MPX" appears in the front panel display and on the TV screen. The sound you hear will have a simulated stereo effect.
- 2 Turn the VOCAL LEVEL control to adjust the balance of the accompaniment and the vocals.

When you turn the control	You will hear the sound as follows:
Clockwise	The vocals are emphasized.
Counterclockwise	The accompaniment is emphasized and the vocals are reduced.

The adjustment may be the opposite of that described above, depending on the disc you are using.

To stop adjusting the balance
Press MPX again. "MPX" disappears from the front panel display.

- Notes**
- When you press MPX in Step 1, the surround sound mode (see page 23) is automatically set to KARAOKE. You can change or cancel the surround sound mode if you like. The last surround sound mode setting is resumed whenever you press MPX.
 - If you press KARAOKE PON (see page 25), MPX will be automatically canceled.
 - When you select ON SCREEN OFF display mode, no information is shown on the TV screen.

Playing Karaoke with Any Stereo Discs (Karaoke Pon)

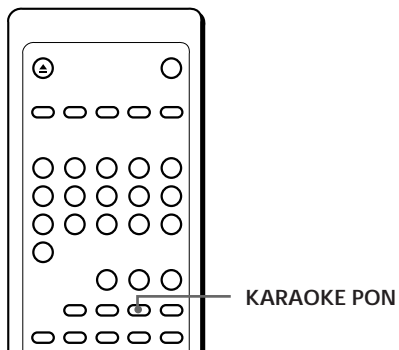
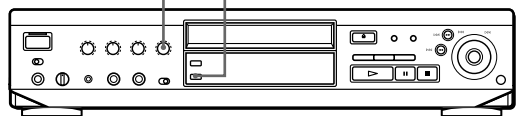

- 1 Press KARAOKE PON.
"KARAOKE PON" appears in the front panel display and "K. PON" appears on the TV screen.

This reduces the singer's voice so that you can enjoy karaoke. However, this also reduces the stereo effect.

- 2 Turn the VOCAL LEVEL control to adjust the singer's voice level.

To cancel Karaoke Pon

Press KARAOKE PON again. "KARAOKE PON" disappears from the front panel display.



When you use Karaoke Pon

Use stereo-recorded discs.

Notes

- Karaoke Pon may not work well for the following cases:
 - Monaural-recorded discs (The accompaniment is also reduced.)
 - Only a few instruments are playing in the stereo-recorded disc
 - A duet is being played
 - The disc has strong echoes or chorus
 - The singer's voice on the disc deviates from the center
 - Multiplex discs
- When you select ON SCREEN OFF display mode, no information is shown on the TV screen.
- If you press MPX (see page 24), Karaoke Pon will be automatically canceled.

Playing Karaoke with Your Video Equipment

Mode selector

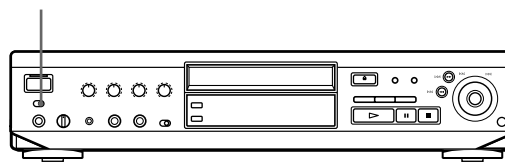

- 1 Connect the video equipment to this player.
See page 6 for details.
- 2 Set the mode selector on the player to LINE IN.
Now you can enjoy karaoke with your video equipment. See pages 10 to 11 on how to use the karaoke functions.

Notes

- You cannot play CDs, when the mode selector is set to LINE IN. If you want to play CDs, set the mode selector to NORMAL or KARAOKE.
- The audio level of the video equipment output from the player may be reduced.
- If the setting of the COLOR SYSTEM switch on the rear panel does not correspond to the color system of the video equipment, the on-screen display may not be displayed properly.

Enjoying Playback Using the PBC Functions

Playing VIDEO CDs with PBC Functions (PBC Playback)

When playing VIDEO CDs with PBC functions (Ver. 2.0 discs), you can enjoy playing simple interactive software, software with search functions, etc. PBC Playback allows you to play VIDEO CDs interactively, following the menu screen on the TV screen.

On this player, you can use the number buttons, JOG SELECTOR, SELECT, PREV ◀◀NEXT ▶▶ and RETURN ↻ during PBC Playback.

Also refer to the instructions supplied with the disc, as the operating procedure may differ according to the VIDEO CD.

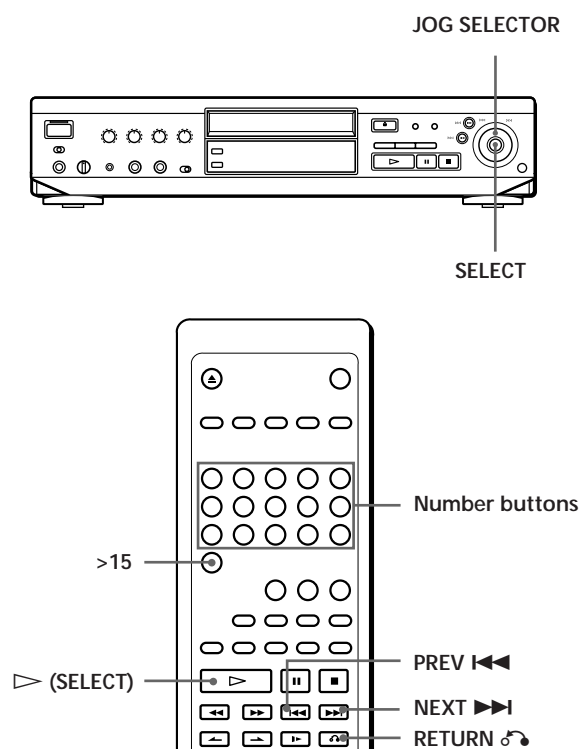

- 1 Start playing a VIDEO CD with PBC functions, following Steps 1 through 5 in "Playing a VIDEO CD" on page 8.

The menu screen appears on the TV screen and "SELECT" flashes.

- 2 Select the item number you want.

On the player

Turn JOG SELECTOR to select the item number, then press SELECT.

On the remote

Press the number button of the item you want. When you want to select an item number over 15, press >15 first, then the corresponding number buttons. To enter "0," use button 10.

Example: To select item number 30
Press >15 first, then 3 and 10.

- 3 Follow the instructions on the menu screen for interactive operations.

When	Do the following
Selecting the item	Turn JOG SELECTOR on the player to select the item number, then press SELECT. Press the number button of the item you want on the remote.
"SELECT" is flashing on the TV screen while playing moving pictures	In this case, you can go to another scene even while playing moving pictures. Turn JOG SELECTOR then press SELECT on the player, or press number button of the item you want on the remote.
Going back to the menu screen	Press RETURN, PREV, or NEXT on the remote. (Also refer to the instructions supplied with the disc, as the operating procedure may differ according to the VIDEO CD.)

When "CANNOT OPERATE NOW" appears on the TV screen

You've pressed an invalid button. Press the correct button, following the instructions on the menu screen.

To cancel PBC Playback of a VIDEO CD with PBC functions and play the disc in Continuous Play mode

There are two ways.

- Before you start playing, select the track you want with JOG SELECTOR or ◀▶ then press SELECT or ▷
- Before you start playing, select the track number using the number buttons on the remote.

"PBC OFF" and "CONTINUE" appear in the front panel display and the player starts Continuous Play. You cannot play still pictures such as a menu screen.

You can use ▷ instead of SELECT after turning Jog Dial.

Enjoying Playback Using the PBC Functions

Example of PBC Playback

This is an example of PBC Playback. Also refer to the instructions supplied with the disc, as the operating procedure may differ according to the VIDEO CD.

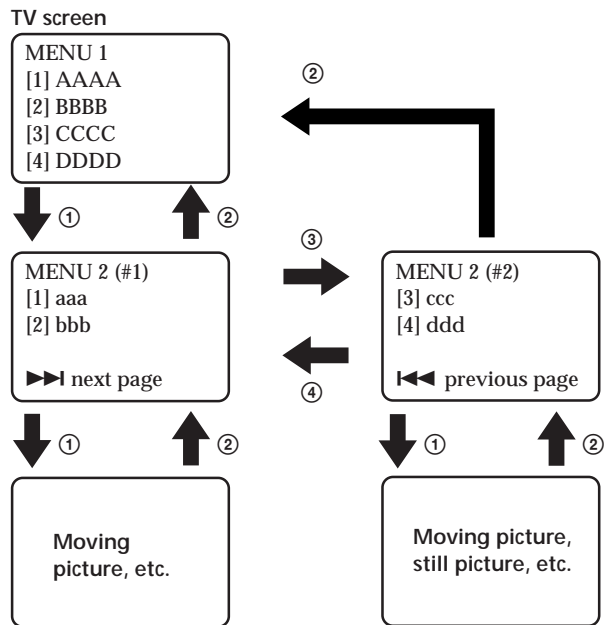

- ① To select the item:
Turn JOG SELECTOR to select the item number, then press SELECT, or select the number button you want on the remote.
- ② To go to the preceding menu:
Press RETURN ↵
- ③ To go to the next page of the menu:
Press NEXT ►►
- ④ To go back to the preceding page of the menu:
Press PREV ◀◀

Locating Scenes Directly Using the Scene Numbers (Scene Search)

On VIDEO CDs with PBC functions, the menu screens, moving pictures and still pictures are divided into "scenes" and each scene is assigned with a scene number.

You can check the current scene number by displaying it on the TV screen during playback (see page 12). Be sure to memorize the scene number from which you want to start playing.

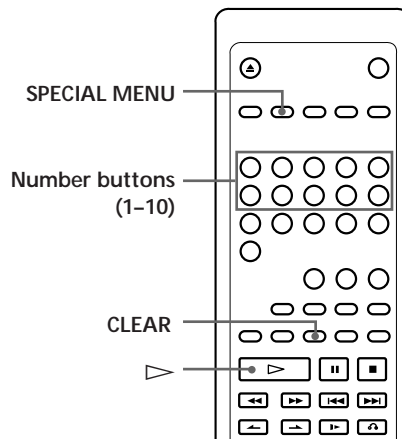

- 1 Press SPECIAL MENU before you start playing or while playing a disc.
The following menu appears on the TV screen while playing a disc.

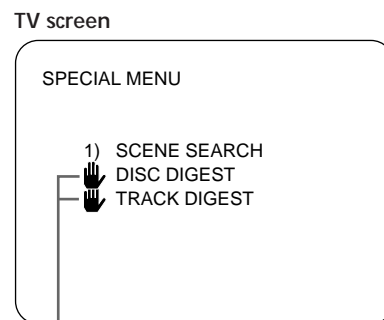

You cannot select the item with this mark.

- 2 Press button 1.
"SCENE -" and the scene numbers appear on the TV screen.

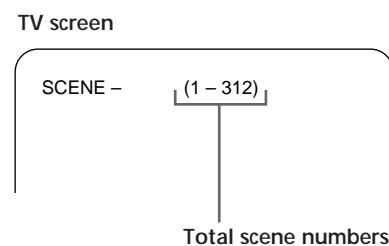

(Continued)

Enjoying Playback Using the PBC Functions

- 3** Press the number buttons (1 – 10) to select the scene.

To enter “0”, use the button 10.

Example: To select scene number 103

Press 1, then 10 and 3.

The selected scene number appears on the TV screen.

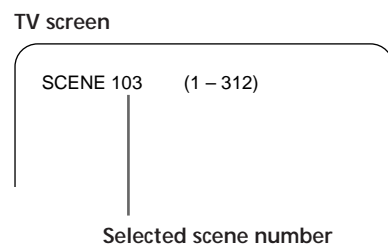

If you've made a mistake

Press CLEAR, then press the correct number button.

- 4** Press \blacktriangleright to start playing from the selected scene.
The player automatically starts PBC Playback (page 26).

-  You can check the scene number while playing a disc
Press ON SCREEN repeatedly to select ON SCREEN 2 display mode (see page 12). The scene numbers appear on the upper left side of the TV screen.

Notes

- Some discs don't allow you to start playing from a particular scene. In this case, when you do the task before you start playing, the player starts playing from scene 1. When you do the task while playing a disc, the player starts playing from the current scene.
- Some discs don't display the selected scene on the TV screen.
- When you select ON SCREEN OFF display mode, no information is shown on the TV screen.

Additional Information

Notes on Discs

On handling discs

- To keep the disc clean, handle the disc by its edge. Do not touch the surface.
- Do not stick paper or tape on the disc.
If there is glue (or a similar substance) on the disc, remove the glue completely before using the disc.

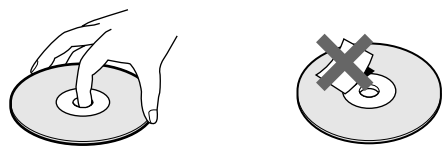

Not this way

- Do not expose the disc to direct sunlight or heat sources such as hot air ducts, or leave it in a car parked in direct sunlight as there can be considerable rise in temperature inside the car.
- After playing, store the disc in its case.

On cleaning

- Before playing, clean the disc with a cleaning cloth. Wipe the disc from the center out.

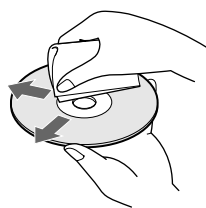

- Do not use solvents such as benzine, thinner, commercially available cleaners or anti-static spray intended for vinyl LPs.

Troubleshooting

If you experience any of the following difficulties while using the player, use this troubleshooting guide to help you remedy the problem. Should any problem persist, consult your nearest Sony dealer.

There's no sound.

- ➔ Check that the player is connected securely.
- ➔ Make sure you operate the TV or the amplifier correctly.
- ➔ Make sure you select the CD player position on the amplifier.

There's no picture.

- ➔ Check that the player is connected securely.
- ➔ Make sure you operate the TV correctly.
- ➔ Make sure you set the COLOR SYSTEM switch correctly, according to your TV.
- ➔ The video signal is not input to the VIDEO IN jack, even when the mode selector is set to LINE IN.

The picture is distorted.

- ➔ Clean the disc (see page 29).

The disc doesn't play.

- ➔ There's no disc inside ("no DISC" appears).
Insert a disc.
- ➔ Insert the disc with the label side up on the disc tray correctly.
- ➔ Clean the disc (see page 29).
- ➔ Moisture has condensed inside the player.
Remove the disc and leave the player turned on for about an hour (see page 2).
- ➔ The mode selector is set to LINE IN. Set the selector to NORMAL or KARAOKE.

The remote doesn't function.

- ➔ Remove the obstacles in the path of the remote and the player.
- ➔ Point the remote at the remote sensor  on the player.
- ➔ Replace all the batteries in the remote with new ones if they are weak.

There's no sound from the microphone.

- ➔ Switch the microphone on.
- ➔ Turn the MIC 1 and/or MIC 2 LEVEL controls clockwise.

Howling occurs.

- ➔ Move the microphone away from the speakers.
- ➔ Lower the volume.
- ➔ Lower the microphone volume or echo level.

The player doesn't play from the first track when playing a VIDEO CD without PBC functions or an audio CD.

- ➔ Press PLAY MODE repeatedly until "CONTINUE" appears in the front panel display, then press .

Additional Information

Specifications

VIDEO CD player

Laser	Semiconductor laser
Wavelength	780 – 790 nm
Signal format system	NTSC, PAL
Frequency response	2 Hz to 20 kHz \pm 1 dB
Signal-to-noise ratio	More than 94 dB

Outputs

	Jack type	Maximum output level	Load impedance
AUDIO OUT	Phono jacks	2 V (at 50 kilohms)	Over 10 kilohms
VIDEO OUT	Phono jack	1 Vp-p	75 ohms, unbalanced, sync negative, white peak
PHONES	Phone jack	10mW	32 ohms

Inputs

	Jack type	Maximum input level	Load impedance
AUDIO IN	Phono jacks	2 V (at 50 kilohms)	Over 10 kilohms
VIDEO IN	Phono jack	1 Vp-p	75 ohms, unbalanced, sync negative
MIC 1, MIC 2	Phone jack	100 mVp-p	600 ohms

General

Power requirements	110 – 120 V or 220 – 240 V AC, adjustable, 50/60 Hz
Power consumption	23 W
Dimensions (approx.) (w/h/d)	430 × 95 × 280 mm incl. projecting parts
Mass (approx.)	3.8 kg

Supplied accessories

Audio and video connecting cord (3 phono plugs – 3 phono plugs) (1)
 Remote commander (remote) (1)
 Sony SUM-3 (NS) batteries (2)
 Plug adaptor (1)

Design and specifications are subject to change without notice.

Glossary

Auto Pause

Automatic pause function that works according to the signal encoded on the disc during PBC playback. In this case, “AUTO ■■” appears in the front panel display. If the player doesn’t resume play for a long time, press ■■ or ▷ to resume play manually.

PBC Playback

Playback using the menu screens recorded on VIDEO CDs with PBC functions. You can enjoy simple interactive operations using the PBC Playback function.

Playback Control (PBC)

Signals encoded on VIDEO CDs (Version 2.0) to control playback.

By using menu screens recorded on VIDEO CDs with PBC functions, you can enjoy playing simple interactive software, software with search functions, and so on.

When you insert a VIDEO CD with PBC functions on this player, “PBC” appears in the front panel display.

Track

Sections of a picture or a music piece on a disc. Each track is assigned with a track number to locate the track you want.

Additional Information

VIDEO CD

A compact disc that contains moving pictures. The picture information uses the MPEG 1 format, one of the world wide standards of digital compact technology. The picture information is compressed about 120 times. Consequently, a 12 cm VIDEO CD can contain up to 74 minutes of moving pictures.

VIDEO CDs also contain compact audio information. Sounds outside the range of human hearing are compressed while the sounds we can hear aren't compressed. VIDEO CDs can hold 6 times the audio information of conventional audio CDs.

There are 2 versions of VIDEO CDs.

- Version 1.1: You can play only moving pictures and sounds.
- Version 2.0: You can play high-resolution still pictures and enjoy PBC functions.

This player conforms to both versions.

Index

A, B

- A-B repeat 19
- Adjusting
 - balance of the accompaniment and the vocals 24
 - echo level 11
 - microphone volume 10
 - volume 8
- AMS 15
- Auto Pause 30
- Automatic Music Sensor. *See* AMS

C

- Color system switch 6
- Comet 22
- Connecting 5
- Continuous play 8

D, E

- Digest Play 17
- Disc Digest 17
- Display
 - front panel display 13
 - on-screen display 12
- DNR 22
- Echo 11

F, G

- Front panel display 13

H

- Handling CDs 29
- Hooking up 5

I, J, K

- Index 16
- Index Search 16
- Karaoke Play 10
- Karaoke Pon 25
- Karaoke Star 24
- Key control 11

L, M, N

- Locating
 - a specific point 16
 - a specific scene 15
 - a specific track 15
 - by monitoring 16
 - by observing the front panel display 16
 - directly 15
 - using AMS 15
 - using index 16
- Multiplex discs 24

O

- On-screen display 12

P, Q

- PBC functions 26, 30
- PBC Playback 26, 30
- Playback
 - Continuous Play 8
 - Karaoke Play 10
 - Program Play 20
 - Repeat Play 19
 - Shuffle Play 20
- Program
 - changing 21
 - checking 21

R

- Remaining time 14
- Remote control 4
- Repeating 19
- Reserving the next tracks 11
- Resume Play 14

S

- Scene 27
- Scene Search 27
- Searching. *See* Locating
- Shuffle Play 20
- Slow-motion Play 16
- Surround sound 23

T

- Total playing time 13
- Track Digest 18
- Troubleshooting 29

U

- Unpacking 4

V, W, X, Y, Z

- VIDEO CDs 4, 8, 31
- Voltage selector 7

Names of controls

Buttons

- A↔B 19
- CHECK 21
- CLEAR 21
- COMET 22
- DNR 22
- INDEX ◀/▶ 16
- KARAOKE PON 25
- KARAOKE STAR 24
- KEY CONTROL b h # 11
- MPX 24
- Number 15, 26
- ON SCREEN 12
- ≡ OPEN/CLOSE 8
- PLAY MODE 20
- PREV ◀◀/NEXT ▶▶ 15, 26
- REPEAT 19
- RETURN ↶ 26
- SELECT 26
- SLOW ▶▶ 16
- SPECIAL MENU 17, 27
- SURROUND 23
- TIME 13
- ▷ 8, 26
- 9
- 9
- ◀◀/▶▶ 9, 15
- ◀◀/▶▶ 16
- >15 15

Switch

- Mode (KARAOKE/NORMAL/LINE IN) 8, 10, 25
- MUSIC LEVEL (LOW/MID/HIGH) 11
- POWER 8

Control

- ECHO LEVEL 11
- JOG SELECTOR 9, 10, 26
- MIC 1, MIC 2 LEVEL 10
- PHONES LEVEL 8
- VOCAL LEVEL 24, 25

Jack

- MIC CONTROL 10
- MIC 1, MIC 2 10
- PHONES 8

Others

- Disc tray 8
- Front panel display 13
- 4

Actual page number:
