

Compact Hi-Fi Stereo System

Operating Instructions



LBT-XB8AVKR

WARNING

To prevent fire or shock hazard, do not expose the unit to rain or moisture.

To avoid electrical shock, do not open the cabinet. Refer servicing to qualified personnel only.

Do not install the appliance in a confined space, such as a bookcase or built-in cabinet.

Laser component in this product is capable of emitting radiation exceeding the limit for Class 1.

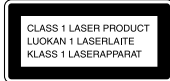

This appliance is classified as a CLASS 1 LASER product. The CLASS 1 LASER PRODUCT MARKING is located on the rear exterior.

The following caution label is located inside the unit.



This stereo system is equipped with the Dolby Pro Logic Surround system* and the Dolby B-type noise reduction system.

* Manufactured under license from Dolby Laboratories Licensing Corporation.

DOLBY, the double-D symbol  and "PRO LOGIC" are trademarks of Dolby Laboratories Licensing Corporation.

Table of Contents

Getting Started

Step 1: Hooking up the system	4
Step 2: Setting up the speakers	6
Step 3: Setting the time	9
Step 4: Presetting radio stations	10
Connecting optional AV components	12

Basic Operations

Playing a CD	14
Recording a CD	16
Listening to the radio	17
Recording from the radio	18
Playing a tape	19
Recording from a tape	21

The CD Player

Using the CD display	22
Playing CD tracks repeatedly	22
Playing CD tracks in random order	23
Programming CD tracks	24
Playing CDs without interruption	25

The Tape Deck

Recording on a tape manually	26
Recording CDs by specifying the track order	27

DJ Mix

Looping part of a CD	29
Flashing part of a CD	29
Waving the equalizer	30

Sound Adjustment

Adjusting the sound	31
Selecting the audio emphasis	32
Adjusting the audio emphasis	33
Making a personal audio emphasis file	35
Enjoying Dolby Pro Logic Surround sound	36

Other Features

Singing along: Karaoke	37
Falling asleep to music	39
Waking up to music	40
Timer-recording radio programs	41

Additional Information

Precautions	43
Troubleshooting	44
Specifications	46
Index	47

Step 1: Hooking up the system

Follow steps **1** through **4** to hook up your system using the supplied cords and accessories.

AM loop antenna



FM antenna

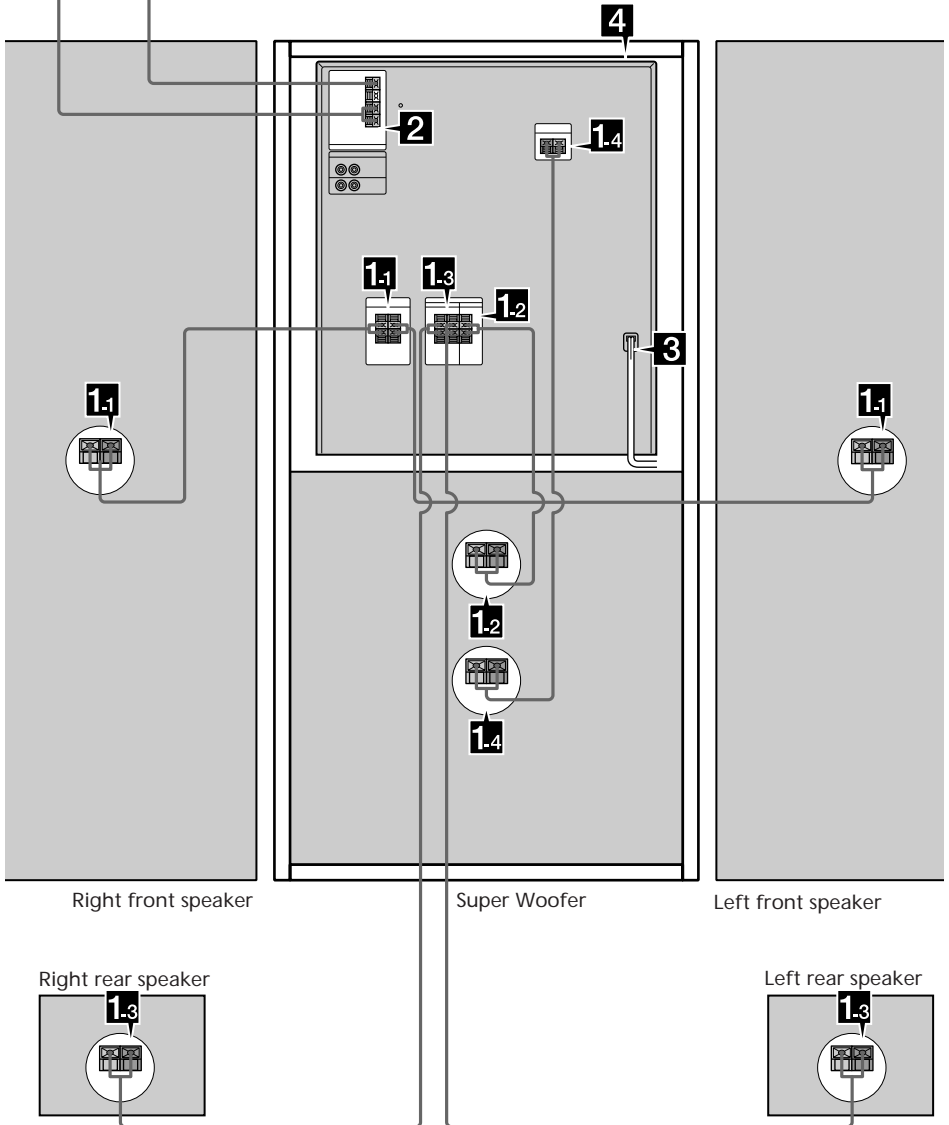

1 Connect the speakers.

- ## 1 Connecting the front speakers
- Connect the speaker cords to the FRONT SPEAKER jacks.

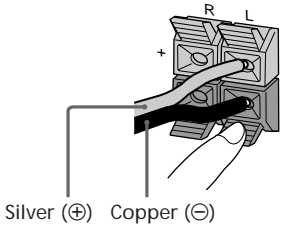

- ## 2 Connecting the Super Woofer (center speaker)
- Connect the speaker cords to the SURROUND SPEAKER CENTER jacks.

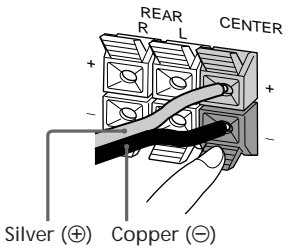

- ## 3 Connecting the rear speakers
- Connect the speaker cords to the SURROUND SPEAKER REAR jacks.

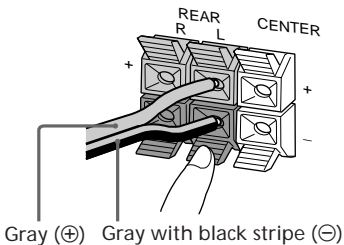

- ## 4 Connecting the center speaker (included in the Super Woofer)
- Connect the speaker cords to the WOOFER SYSTEM jacks.

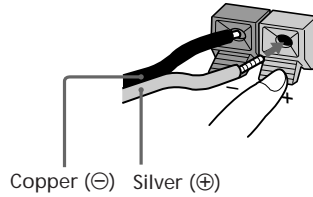

Notes

- Keep the speaker cords away from the antennas to prevent noise.
- Insert only the stripped portion of the cord. Inserting the vinyl portion will interfere with the speaker connection and no sound will come from the speaker.

2 Connect the FM/AM antennas.

- Set up the AM loop antenna, then connect it.

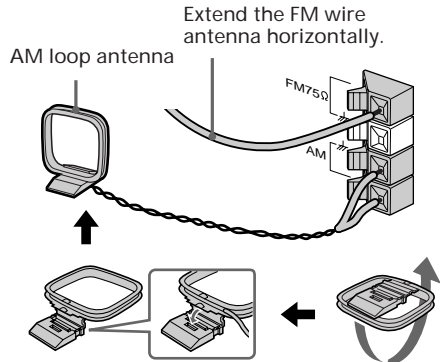

3 Connect the power cord to a wall outlet.

- The demonstration appears in the display.

4 Deactivate the demonstration mode by pressing DISPLAY/DEMO while the system is off.

Step 1: Hooking up the system (continued)

Inserting two size AA (R6) batteries into the remote

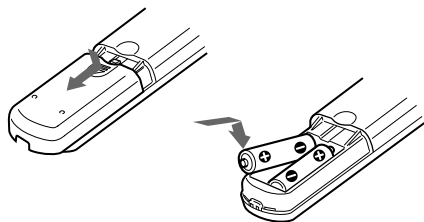

Tips

- With normal use, the batteries should last for about six months. When the remote no longer operates the system, replace both batteries with new ones.
- When you set the time, the demonstration is deactivated.

To activate the demonstration again, press DISPLAY/DEMO while the system is off.

Note

If you do not use the remote for a long period of time, remove the batteries to avoid possible damage from battery leakage.

When carrying this system

Do the following to protect the CD mechanism.

- 1 Press FUNCTION repeatedly until "CD" appears in the display.
- 2 Hold down PLAY MODE and press POWER to turn off the system.

Step 2: Setting up the speakers

By connecting the supplied speakers, you can enjoy Dolby Pro Logic Surround sound. Dolby Pro Logic Surround is a decoding system standardized in TV programs and movies. Dolby Pro Logic Surround improves the sound image by using four separate channels. These channels manipulate the sound to enhance the action as it happens on the screen.

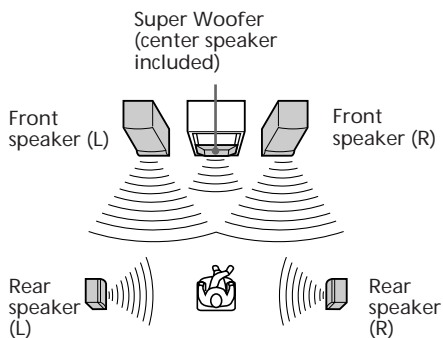

Positioning the center and rear speakers

Before you connect them, determine the best location for your speakers.

- 1 Place the front speakers at an angle of 45 degrees from your listening position.

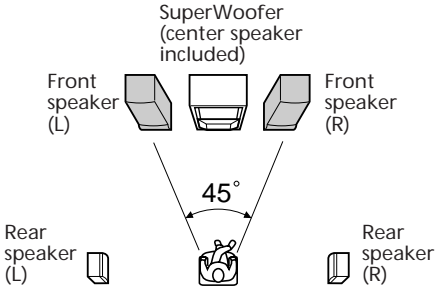

- 2 Place the rear speakers facing each other at about 60 to 90 cm above your listening position.

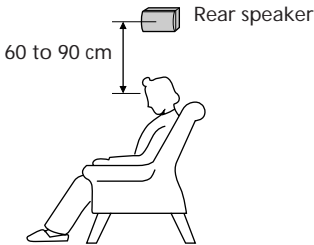

Adjusting the speaker volume

To enjoy Dolby Pro Logic Surround sound, adjust the volume of each speaker using the test tone that the system provides.

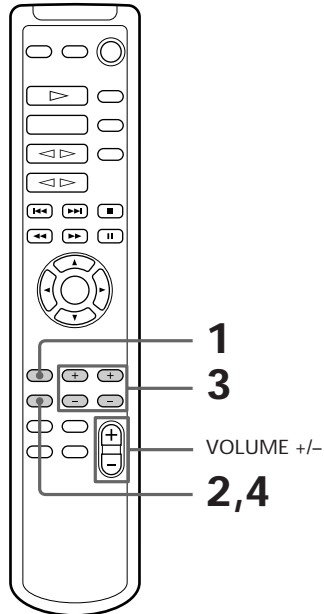
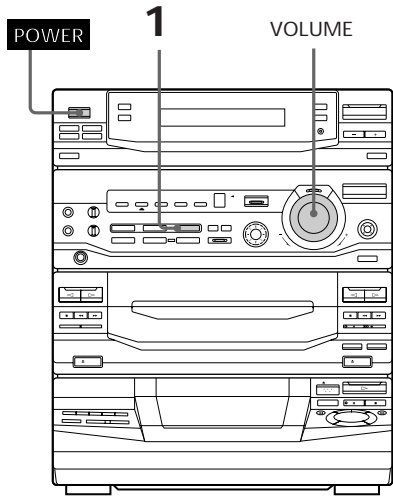

Step 2: Setting up the speakers (continued)

1 Press PRO LOGIC (or PRO LOGIC ON/OFF on the remote).
The indicator on this button lights up.

2 Press T. TONE ON/OFF on the remote.
The test tone is heard from the speakers in the following order. Adjust the volume of the test tone.

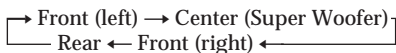

3 From your listening position, press CENTER LEVEL +/- and REAR LEVEL +/- on the remote to adjust the volume levels.
The volume levels from each speaker should be the same.

4 Press T. TONE ON/OFF when you are done adjusting.
The test tone is turned off.

Note

The test tone feature works only for Dolby Pro Logic Surround sound.

Tip

If you turn VOLUME (or press VOLUME +/- on the remote), all the speaker volumes change.

Step 3: Setting the time

You must set the time before using the timer functions.

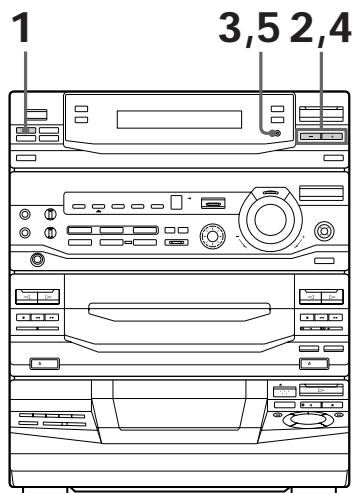

- 1 Press \ominus /CLOCK SET.
The hour indication flashes.



- 2 Press TUNING +/- to set the hour.
The clock uses the 12-hour system.



- 3 Press ENTER/NEXT.
The minutes indication flashes.

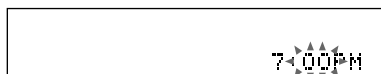

- 4 Press TUNING +/- to set the minutes.



- 5 Press ENTER/NEXT.
The clock starts.

Tip

If you make a mistake, start over from step 1.

Step 4: Presetting radio stations

You can preset up to 30 stations, 20 for FM and 10 for AM.

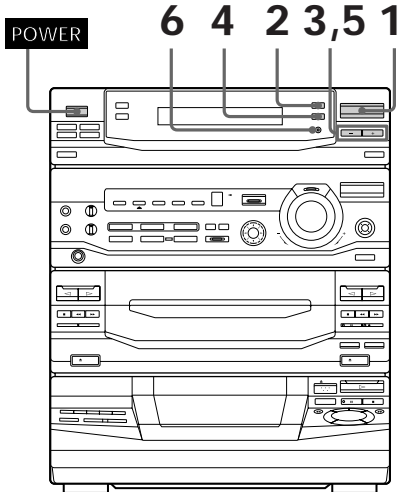

- 1 Press TUNER/BAND repeatedly until the band you want appears in the display.

Each time you press this button, the band changes as follows:

FM ↔ AM

- 2 Press TUNING MODE repeatedly until "AUTO" appears in the display.

- 3 Press TUNING +/-.

The frequency indication changes and scanning stops when the system tunes in a station. "TUNED" and "STEREO" (for a stereo program) appear.



- 4 Press TUNER MEMORY.

A preset number flashes in the display.



- 5 Press TUNING +/- to select the preset number you want.



- 6 Press ENTER/NEXT.

The station is stored.

- 7 Repeat steps 1 through 6 to store other stations.

To tune in a station with a weak signal

Press TUNING MODE repeatedly until "MANUAL" appears in step 2, then press TUNING +/- to tune in the station.

To change the preset number

Start over from step 1.

To change the AM tuning interval

The AM tuning interval is factory-preset to 9 kHz (10 kHz in some areas). To change the AM tuning interval to 10 kHz (or 9 kHz), press TUNER/BAND repeatedly until "AM" appears first, then turn off the system. While holding down ENTER/NEXT, turn the system back on. When you change the interval, the AM preset stations will be erased. To reset the interval, repeat the same procedure.

Note

The preset stations are canceled when you disconnect the power cord or if a power failure occurs for half a day.

Connecting optional AV components

To enhance your system, you can connect optional components. Refer to the instructions included with each component for details.

Connecting a TV/VCR

You can connect a TV and VCR to enjoy Dolby Pro Logic Surround encoded videos and TV programs.

Be sure to match the color of the plugs and the connectors. To listen to the sound from the connected TV/VCR, press FUNCTION repeatedly until "VIDEO" appears.

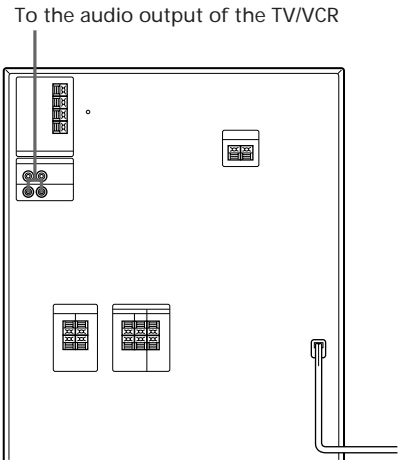

Connecting audio components

Connecting a turntable

Be sure to match the color of the plugs and the connectors. To listen to the sound from the connected turntable, press FUNCTION repeatedly until "PHONO" appears.

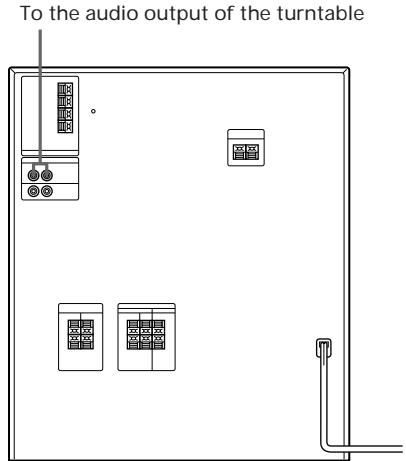

Note

Using the turntable at high volume may cause distortion or howling. This is often caused by the bass sound from the speakers. The bass sound may be picked up by the needle of the turntable, and produce the distortion or howling. To avoid this, do the following:

- 1 Keep some distance between the speakers and the turntable.
- 2 Stop using the surround effect.
- 3 Install the speakers or the turntable on a firm and stable surface.
- 4 Press DBFB repeatedly until "DBFB" disappears from the display.
- 5 Set the SUPER WOOFER switch on the Super Woofer speaker to OFF.

Connecting outdoor antennas

Connect an outdoor antenna to improve the reception.

FM antenna

Connect an optional FM outdoor antenna. You can also use the TV antenna instead.

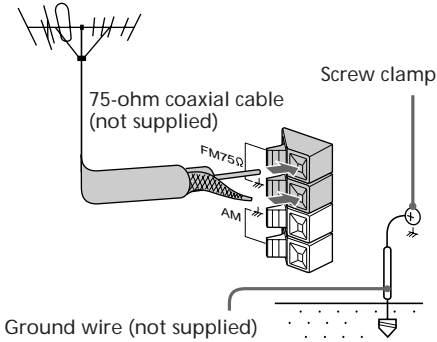

AM antenna

Connect a 6 to 15 meter insulated wire to the AM antenna terminal. Leave the supplied AM antenna connected.

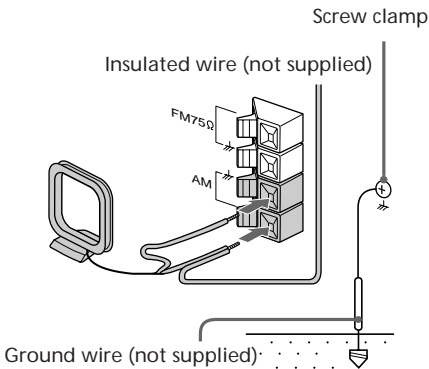

Important

If you connect an outdoor antenna, connect a ground wire to the ⚡ terminal with the screw clamp. To prevent a gas explosion, do not connect the ground wire to a gas pipe.

Playing a CD

— Normal Play

You can play up to five CDs in a row.

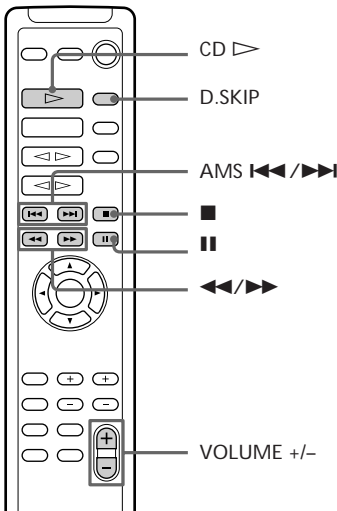
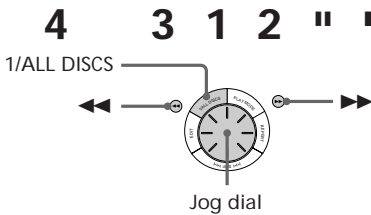
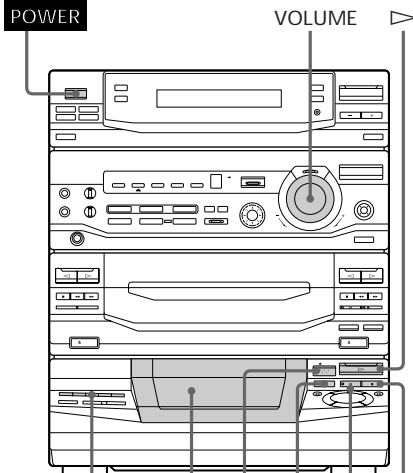

- 1 Press **▲ OPEN** and place a CD on the disc tray.
If the disc is not placed properly it will not be recognized.

With the label side up. When you play a CD single, place it on the inner circle of the tray.

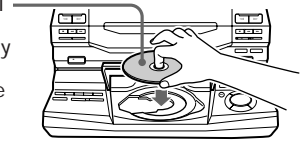

- 2 Press **DISC SKIP** to place up to four more CDs on the tray.
The disc tray rotates so you can insert other CDs.

- 3 Close the front cover.

- 4 Press one of the **DIRECT PLAY** buttons.
Playback starts.
If you press **▷** (or **CD ▷** on the remote), playback starts from the CD in the playing position.

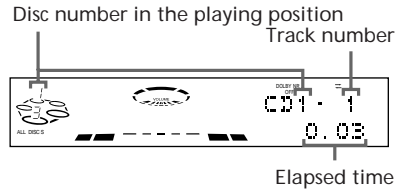

To	Do this
Stop playback	Press ■.
Pause	Press ■■. Press again to resume playback.
Select a track	During playback or pause, turn the jog dial clockwise (to go forward) or counterclockwise (to go backward) and release it when you reach the desired track. Or press AMS* ►► (to go forward) or AMS* ◄◄ (to go backward) on the remote.
Find a point in a track	Press and hold ►► or ◄◄ during playback, and release at the desired point.
Select a CD	Press one of the DIRECT PLAY buttons. Or press DISC SKIP (or press D.SKIP on the remote).
Play only the CD you have selected	Press 1/ALL DISCS repeatedly until "1 DISC" appears.
Play all CDs	Press 1/ALL DISCS repeatedly until "ALL DISCS" appears.
Remove or change the CDs	Press ▲ OPEN.
Adjust the volume	Turn VOLUME (or press VOLUME +/- on the remote).

* AMS: Automatic Music Sensor.

Tips

- Pressing ▷ while the system is off automatically turns on the system and starts CD playback if there is a CD on the tray (One Touch Play).
- You can switch from another source to the CD player and start playing a CD just by pressing ▷ or one of the DIRECT PLAY buttons (Automatic Source Selection).
- If there is no CD in the player, "NO DISC" appears in the display.
- You can change the CD in the loading position during playback.

Recording a CD

— CD Synchro Recording

This function lets you record from a CD to a tape easily. You can use TYPE I (normal) or TYPE II (CrO₂) tapes. The recording level is adjusted automatically.

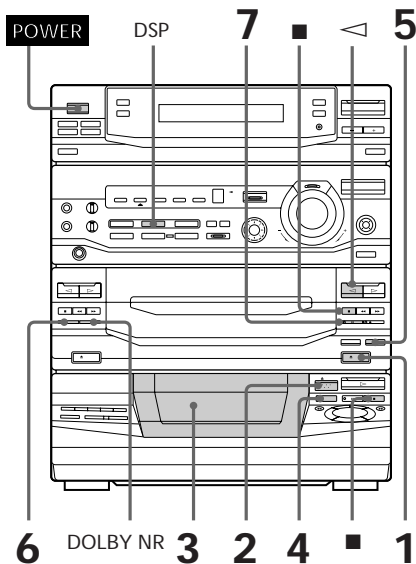

- 1 Press ▲ EJECT and insert a blank tape into deck B.

With the side you want to record on facing forward

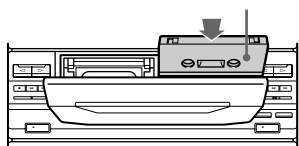

- 2 Press ▲ OPEN and place a CD.

With the label side up. When you play a CD single, place it on the inner circle of the tray.

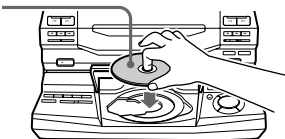

- 3 Close the front cover.
- 4 Press DISC SKIP repeatedly until the disc number you want to record appears in the playing position indicator.
- 5 Press CD SYNC.
Deck B stands by for recording and the CD player stands by for playback, and the indicator on the ▷ button (for the front side) lights up green.
- 6 Press DIRECTION repeatedly to select ⇌ to record on one side or ↔ (or RELAY) to record on both sides.
- 7 Press II on deck B.
Recording starts.

To stop recording

Press ■ on deck B or on the CD player.

Tips

- If you want to record on the reverse side, press ◀ so the indicator on the ◀ button (for the reverse side) lights up green.
- When you record on both sides, be sure to start from the front side. If you start from the reverse side, recording stops at the end of the reverse side.
- When you want to reduce the hiss noise in low-level high-frequency signals, press DOLBY NR before step 7 so "DOLBY NR B" appears in the display.
- To record with the surround effect, press DSP (or DSP MODE on the remote) so "SUR (|||||)" appears in the display.
The equalizer settings will not be recorded.

Note

You cannot listen to other sources while recording.

Listening to the radio

— Preset Tuning

Before using this function, preset radio stations in the tuner's memory (see “Step 4: Presetting radio stations”).

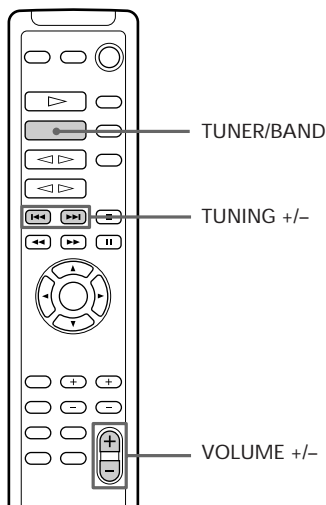
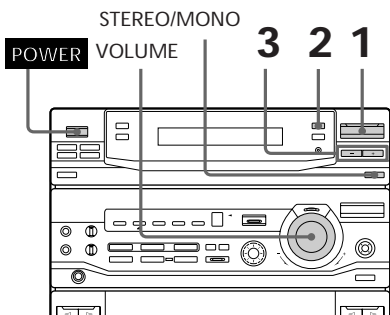

1 Press TUNER/BAND repeatedly until the band you want appears in the display.

Each time you press this button, the band changes as follows:

FM ↔ AM

2 Press TUNING MODE repeatedly until “PRESET” appears in the display.

MANUAL → AUTO → PRESET



3 Press TUNING +/- to tune in the desired preset station.

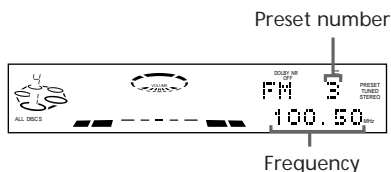

To	Do this
Turn off the radio	Press POWER.
Adjust the volume	Turn VOLUME (or press VOLUME +/- on the remote).

To listen to non-preset radio stations

Press TUNING MODE repeatedly in step 2 until “MANUAL” appears, then press TUNING +/- to tune in the desired station.

Tips

- Pressing TUNER/BAND while the system is off automatically turns on the system and tunes to the last received station (One Touch Play).
- You can switch from another source to the radio just by pressing TUNER/BAND (Automatic Source Selection).
- If an FM program is noisy, press STEREO/MONO so “MONO” appears in the display. There will be no stereo effect, but the reception will improve. Press this button again to restore the stereo effect.
- To improve broadcast reception, move the supplied antennas.

Recording from the radio

You can record a radio program on a tape by tuning in a preset station. You can use TYPE I (normal) or TYPE II (CrO₂) tapes. The recording level is automatically adjusted.

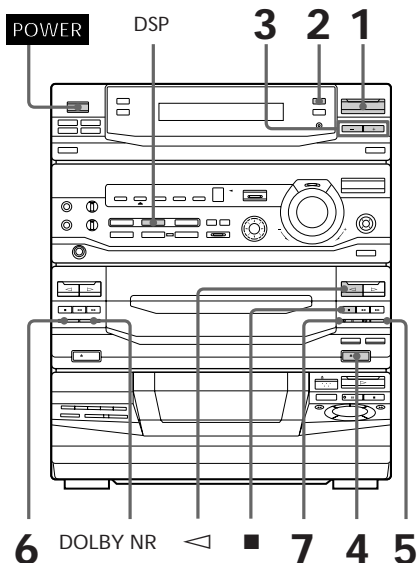

1 Press TUNER/BAND repeatedly until the band you want appears in the display.

2 Press TUNING MODE repeatedly until "PRESET" appears in the display.

3 Press TUNING +/- to tune in a preset station.

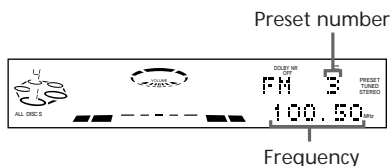

4 Press EJECT and insert a blank tape into deck B.

With the side you want to record on facing forward

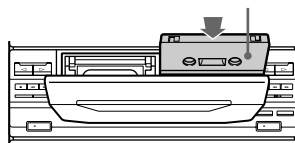

5 Press REC.
Deck B stands by for recording, and the indicator on the button (for the front side) lights up green.

6 Press DIRECTION repeatedly to select to record on one side or (or RELAY) to record on both sides.

7 Press on deck B.
Recording starts.

To stop recording

Press on deck B.

Tips

- If you want to record on the reverse side, press ◀ so the indicator on the ◀ button (for the reverse side) lights up green.
- When you record on both sides, be sure to start from the front side. If you start from the reverse side, recording stops at the end of the reverse side.
- To record non-preset stations, select “MANUAL” in step 2, then press TUNING +/- to tune in the desired station.
- When you want to reduce the hiss noise in low-level high-frequency signals, press DOLBY NR before step 7 so “DOLBY NR B” appears in the display.
- To record with surround effect, press DSP (or DSP MODE on the remote) so “SUR {{{|■■|}}” appears in the display.
The equalizer settings will not be recorded.
- If noise is heard while recording from the radio, move the appropriate antenna to reduce the noise.

Playing a tape

You can play any type of tape, TYPE I (normal), TYPE II (CrO₂) or TYPE IV (metal). The deck automatically detects the tape type. To select either deck A or B, press DECK A ◀▶ or DECK B ◀▶ on the remote.

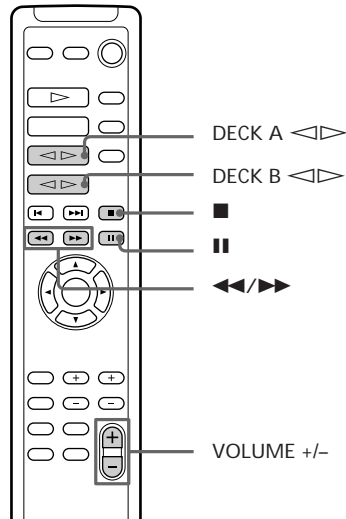
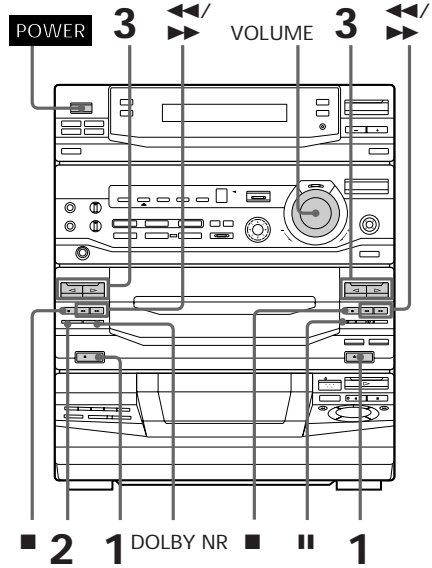

continued

Playing a Tape (continued)

- 1 Press **▲ EJECT** and insert a recorded tape in deck A or B.

With the side you want to play facing forward

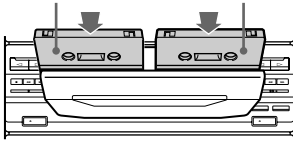

- 2 Press **DIRECTION** repeatedly to select **↔** to play one side, **↔↔*** to play both sides, or **RELAY (Relay Play)**** to play both decks in succession.

- 3 Press **▷**.

Press **◁** to play the reverse side. The tape starts playing.

* The deck stops automatically after playing both sides five times.

** Relay Play always plays according to the following sequence:

Deck A (front side), Deck A (reverse side), Deck B (front side), Deck B (reverse side).

To	Do this
Stop play	Press ■ .
Pause (Deck B only)	Press ■ . Press again to resume play.
Fast-forward	Press ▶▶ while playing the front side or ◀◀ while playing the reverse side.
Rewind	Press ◀◀ while playing the front side or ▶▶ while playing the reverse side.
Remove the cassette	Press ▲ EJECT .
Adjust the volume	Turn VOLUME (or press VOLUME +/- on the remote).

Tips

- Pressing **▷** or **◁** while the system is off automatically turns on the system and starts tape playback if there is a tape in the deck (One Touch Play).
- You can switch from another source to the tape deck just by pressing **▷** or **◁** (Automatic Source Selection).
- When you want to reduce the hiss noise in low-level high-frequency signals, press **DOLBY NR** so "DOLBY NR B" appears in the display.

Recording from a tape

— High-speed Dubbing

You can use TYPE I (normal) or TYPE II (CrO₂) tapes. The recording level is automatically adjusted.

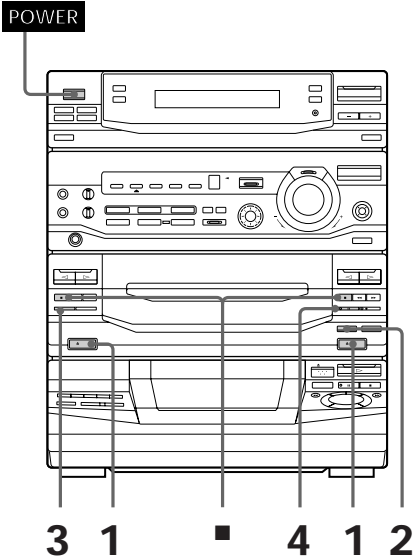

- 1 Press **▲ EJECT** and insert a recorded tape in deck A and a blank tape in deck B.

With the side you want to play/record on facing forward

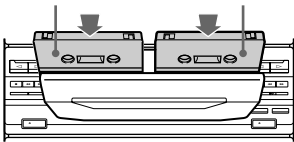

- 2 Press **H SPEED DUB**.
Deck B stands by for recording.

- 3 Press **DIRECTION** repeatedly to select **↔** to record on one side or **↔↔** (or **RELAY**) to record on both sides.

- 4 Press **II**.
Dubbing starts.
When dubbing ends, decks A and B automatically stop.

To stop dubbing

Press **■** on deck A or B.

Tips

- When you dub on both sides, start recording from the front side. If you start from the reverse side, recording stops at the end of the reverse side.
- If you set **DIRECTION** to **↔↔** when the tapes you use have different lengths, the tape in each deck reverses independently. If you select **RELAY**, the tapes in both decks reverse together.
- You don't have to set **DOLBY NR**, since the tape in deck B is automatically recorded in the same state as the tape in deck A.

Note

You cannot record the surround effect.

Using the CD display

You can check the remaining time of the current track or the whole CD.

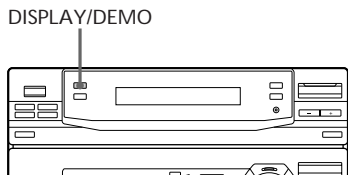

➔ Press DISPLAY/DEMO during playback.

Each time you press this button in Normal Play, the display changes as follows:

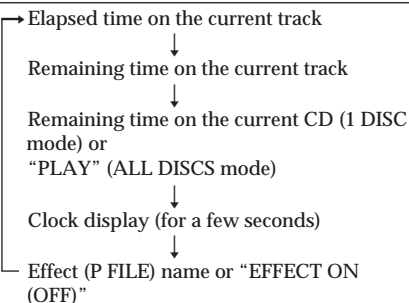

To check the total playing time and the number of tracks on a CD

Press DISPLAY/DEMO in stop mode.

If you press DISPLAY/DEMO again, the clock display appears for a few seconds then the display returns to the previous indication.

Playing CD tracks repeatedly

— Repeat Play

This function lets you repeat a single CD or all CDs in Normal Play, Shuffle Play, and Program Play.

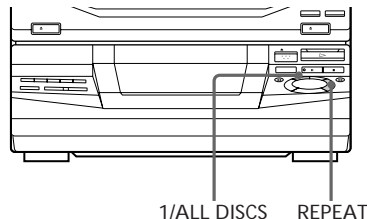

➔ Press REPEAT repeatedly during playback until "REPEAT" appears in the display.

Repeat Play starts. The following table describes the various repeat modes.

To repeat	Press
All the tracks on the current CD	1/ALL DISCS repeatedly until "1 DISC" appears in the display.
All the tracks on all CDs	1/ALL DISCS repeatedly until "ALL DISCS" appears in the display.
Only one track*	REPEAT repeatedly while playing the track you want to repeat until "REPEAT 1" appears in the display.

* You can't repeat a single track during Shuffle Play and Program Play.

To cancel Repeat Play

Press REPEAT repeatedly until "REPEAT" or "REPEAT 1" disappears from the display.

Playing CD tracks in random order

— Shuffle Play

You can play all the tracks on one CD or all the CDs in random order.

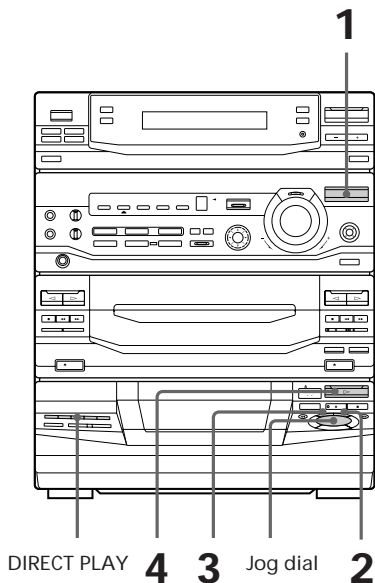

To cancel Shuffle Play

Press PLAY MODE repeatedly until “SHUFFLE” or “PROGRAM” disappears from the display. The tracks continue playing in their original order.

To select a desired CD

Press one of the DIRECT PLAY buttons during 1 Disc Shuffle Play.

Tips

- You can start Shuffle Play during Normal Play by pressing PLAY MODE repeatedly until “SHUFFLE” appears in the display.
- To skip a track, turn the jog dial clockwise (or press AMS ►► on the remote).

1 Press FUNCTION repeatedly until “CD” appears in the display.

2 Press PLAY MODE repeatedly until “SHUFFLE” appears in the display.

3 Press 1/ALL DISCS to choose “1 DISC” or “ALL DISCS.”
“All DISCS” shuffles the tracks on all the CDs in the player. “1 DISC” shuffles the tracks on the CD in the playing position.

4 Press ►.
“◀▶” appears and all the tracks play in random order.

Programming CD tracks

— Program Play

You can create a program of up to 32 tracks from all the CDs in the order you want them to be played.

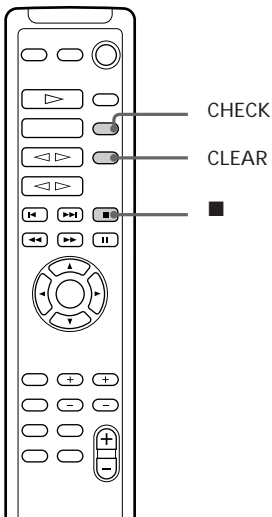
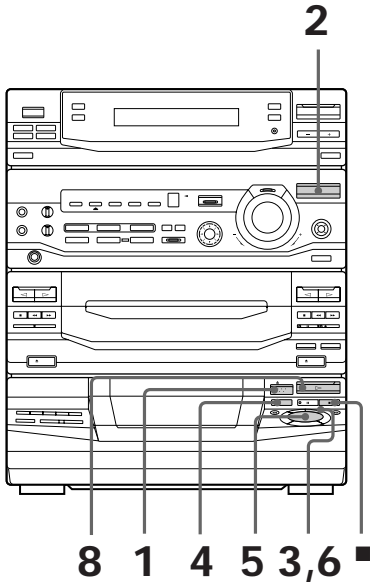

- 1 Place CDs and close the front cover.
- 2 Press FUNCTION repeatedly until “CD” appears in the display.
- 3 Press PLAY MODE repeatedly until “PROGRAM” appears in the display.

- 4 Press DISC SKIP to select a CD.

- 5 Turn the jog dial until the desired track appears in the display.

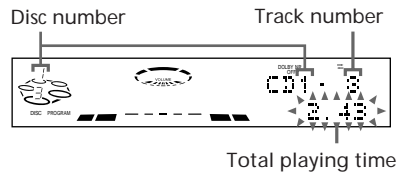

- 6 Press PLAY MODE once. The track is programmed. “STEP” and the programmed playing order appear, followed by the total playing time.

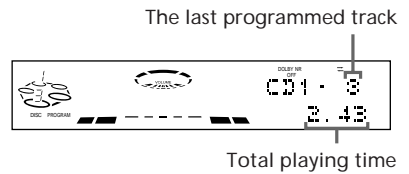

- 7 To program additional tracks, repeat steps 4 through 6. Skip step 4 to select tracks from the same disc.

- 8 Press ▷. All the tracks play in the order you selected.

To cancel Program Play

Press PLAY MODE repeatedly until "PROGRAM" or "SHUFFLE" disappears from the display.

To	Press
Check the program	CHECK on the remote repeatedly. After the last track, "CHECK END" appears.
Clear the last selected track	CLEAR on the remote in stop mode.
Clear a specific track	CHECK on the remote repeatedly until the number of the track to be cleared lights up, then press CLEAR.
Add a track to the program	1 Press DISC SKIP to select a CD. 2 Turn the jog dial to select a track. 3 Press PLAY MODE.
Clear the entire program	■ once in stop mode or twice while playing.

Tips

- The program you created remains in the CD player's memory even after it has been played. Press ▷ to play the same program again.
- If "--:--" appears instead of the total playing time while programming, this means:
 - you have programmed a track numbered over 20, or
 - the total playing time has exceeded 100 minutes.

Playing CDs without interruption

-- Non-Stop Play

You can play CDs without pausing between tracks.

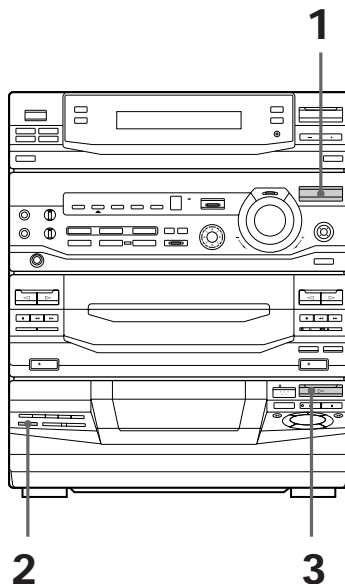

1 Press FUNCTION repeatedly until "CD" appears in the display.

2 Press NON-STOP so the indicator on this button lights up.

3 Press ▷.

To cancel Non-Stop Play

Press NON-STOP so the indicator on this button goes off.

Recording on a tape manually

You can record from CDs, tapes, or the radio as you like. For example, you can record just the songs you want or begin recording from the middle of the tape. The recording level is adjusted automatically.

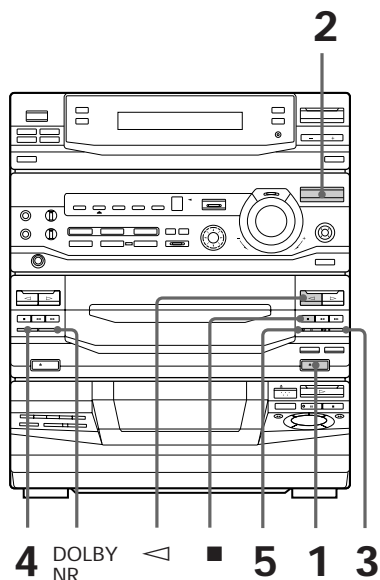

- 1** Insert a blank tape into deck B.
- 2** Press FUNCTION repeatedly until the source you want to record (e.g., CD) appears in the display.
- 3** Press ● REC.
Deck B stands by for recording, and the indicator on the ▷ button (for the front side) lights up green.
- 4** Press DIRECTION repeatedly to select ↔ to record on one side or ⇄ (or RELAY) to record on both sides.

- 5** Press || on deck B.
Recording starts.

- 6** Start playing the source to be recorded.

To	Press
Stop recording	■ on deck B
Pause recording	on deck B

Tips

- If you want to record on the reverse side, press ◀ so the indicator on the ◀ button (for the reverse side) lights up green.
- When you want to reduce the hiss noise in low-level high-frequency signals, press DOLBY NR before step 5 so "DOLBY NR B" appears in the display.

Recording CDs by specifying the track order

— Program Edit

You can record tracks from all the CDs in the order you want. When programming, make sure the playing times for each side do not exceed the length of one side of the tape.

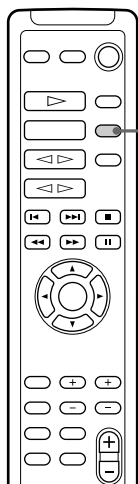
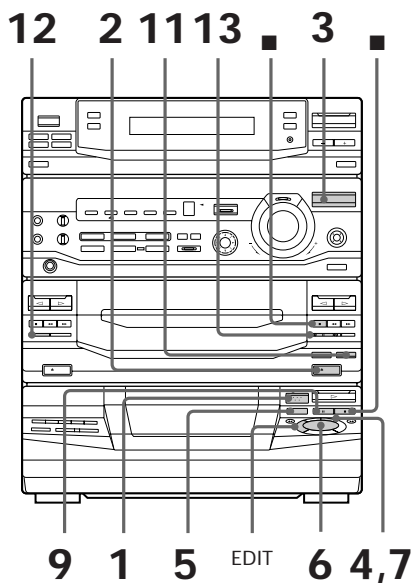

- 1 Place CDs and close the front cover.
- 2 Insert a blank tape into deck B.
- 3 Press FUNCTION repeatedly until "CD" appears in the display.
- 4 Press PLAY MODE repeatedly until "PROGRAM" appears in the display.
- 5 Press DISC SKIP to select a CD.
- 6 Turn the jog dial until the desired track appears in the display.

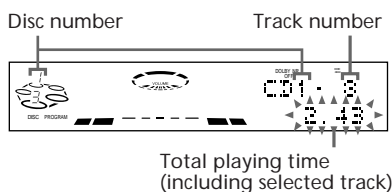

- 7 Press PLAY MODE once. The track is programmed. "STEP" and the programmed playing order appear, followed by the total playing time.

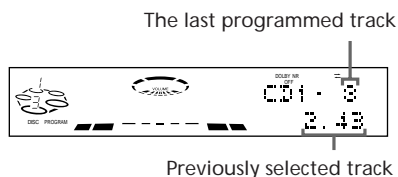

- 8 Repeat steps 5 through 7 to program additional tracks to be recorded on side A. Skip step 5 to select tracks from the same disc.
- 9 Press **II** to insert a pause at the end of side A. "P" appears in the display and the total playing time resets to "0.00" in the display.

Recording CDs by specifying the track order (continued)

10 Repeat steps 5 through 7 to program the tracks to be recorded on side B. Skip step 5 to select tracks from the same disc.

11 Press CD SYNC.
Deck B stands by for recording, the CD player stands by for playback, and the indicator on the ▷ button (for the front side) lights up green.

12 Press DIRECTION repeatedly to select ⇄ to record on one side, or ⇄⇄ (or RELAY) to record on both sides.

13 Press ■ on deck B.
Recording starts.

To stop recording

Press ■ on deck B or on the CD player.

To check the order

Press CHECK on the remote repeatedly. After the last track, "CHECK END" appears.

To cancel Program Edit

Press PLAY MODE repeatedly until "PROGRAM" or "SHUFFLE" disappears from the display.

Selecting the tape length automatically

— Tape Select Edit

You can check the most suitable tape length for recording a CD. Note that you cannot use Tape Select Edit for discs containing more than 20 tracks.

➔ After inserting a CD, press EDIT once so "EDIT" flashes.

The required tape length for the CD in the playing position appears, followed by the total playing time for sides A and B.

Note

You cannot use this function when Program Play mode has been set. After clearing the entire program (see "To clear the entire program" on page 25), follow the above procedure.

Looping part of a CD

— Loop

With the loop function, you can repeat part of a CD during playback. This lets you create original recordings.

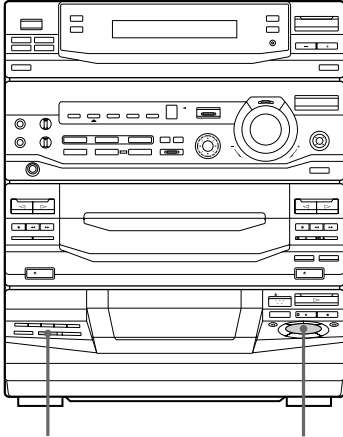

LOOP

Jog dial

➔ Press and hold LOOP during playback at the point you want to start the Loop function, and release to resume normal playback.

To adjust the loop length

Turn the jog dial while holding LOOP (or press MUSIC MENU \leftarrow/\rightarrow while holding LOOP on the remote) to select different loop lengths.

Flashing part of a CD

— Flash

With the flash function, you can “flash” the CD sound during playback. This lets you create original recordings.

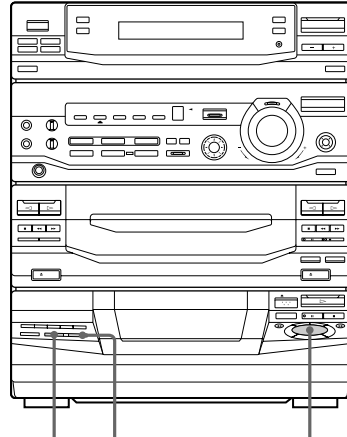

LOOP FLASH

Jog dial

➔ Press and hold FLASH during playback at the point you want to start the Flash function, and release to resume normal playback.

To adjust the flash length

Turn the jog dial while holding FLASH (or press MUSIC MENU \leftarrow/\rightarrow while holding FLASH on the remote) to select different flash lengths.

To use LOOP and FLASH together

Press and hold both LOOP and FLASH at the same time.

Note

The loop and flash length cannot be adjusted in stop mode. Adjust the loop and flash lengths during operation.

Waving the equalizer

— Wave

With the Wave function, you can fluctuate the graphic equalizer automatically while listening to a source. This effect can be used with any source, but it cannot be recorded.

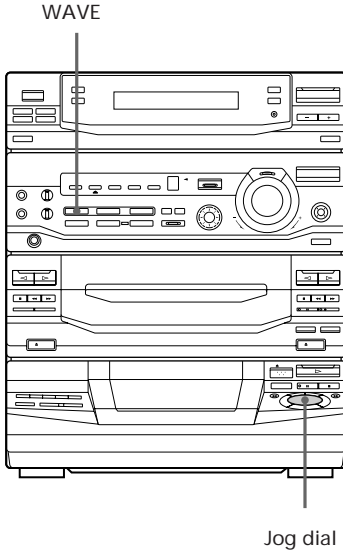

➔ Press and hold WAVE while listening to a source at the point you want to start the Wave function, and release to resume normal playback.

To adjust the wave length

Turn the jog dial while holding WAVE to select different wave lengths.

Adjusting the sound

You can reinforce the bass, create a more powerful sound, and listen with headphones.

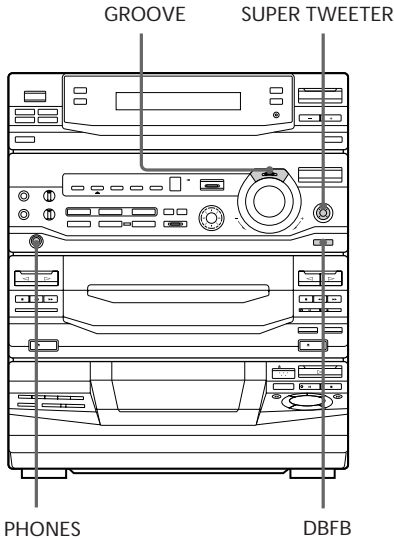

To reinforce the treble sound

Press SUPER TWEETER.

To cancel the SUPER TWEETER

Press SUPER TWEETER again.

To cancel the SUPER WOOFER

The SUPER WOOFER is factory pressed to ON. The reinforced bass sound comes from the supplied SUPER WOOFER speaker.

To cancel the SUPER WOOFER, set the SUPER WOOFER switch on the front panel to OFF.

Notes

- When you use the turntable, adjusting the volume high may cause distortion or howling. In this case, set the SUPER WOOFER switch to OFF.
- Canceling GROOVE cancels the equalizer curve and bass level. Adjust the equalization to obtain the effect you desire.

To listen through the headphones

Connect the headphones to the PHONES jack.

No sound will come from the speakers.

To reinforce the bass (DBFB)

Press DBFB.*

Each time you press this button, the DBFB level display changes as follows:

DBFB ■■■ → DBFB ■■■■■ → display off



“DBFB ■■■■■” reinforces the bass more than “DBFB ■■■”.

*DBFB = Dynamic Bass Feedback

For a powerful sound (GROOVE)

Press GROOVE.

The volume switches to power mode, the equalizer curve changes, the bass level (DBFB) changes to “HIGH” and the indicator on the GROOVE button lights up. Press GROOVE again to return to the previous volume.

Selecting the audio emphasis

The audio emphasis menu lets you select the sound characteristics according to the music you are listening to.

The personal file function (see “Making a personal audio emphasis file (Personal File)”) lets you store your own effects.

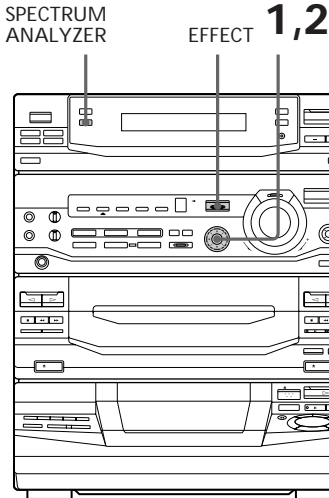

1 Press GEQ \uparrow/\downarrow (or MUSIC MENU \uparrow/\downarrow on the remote) repeatedly to select MENU 1 or MENU 2. See the chart “Music menu options” below. The last audio emphasis chosen from that menu appears in the display.

2 Press GEQ \leftarrow/\rightarrow (or MUSIC MENU \leftarrow/\rightarrow on the remote) repeatedly to select the audio emphasis you desire. The audio emphasis name appears in the display.

To cancel the audio emphasis

Press EFFECT (or MUSIC MENU ON/OFF on the remote) repeatedly so the indicator on the EFFECT button goes off.

Music menu options

“SUR (|||||)” appears if you select an audio emphasis with a surround effect.

Press	To select	
GEQ \uparrow/\downarrow	MENU 1	MENU 2
GEQ \leftarrow/\rightarrow	ROCK	MOVIE
	POP	GAME
	JAZZ	NIGHT
	DANCE	PARTY
	SALSA	RELAX

To change the equalizer display

Each time you press SPECTRUM ANALYZER, the equalizer display changes to show one of the four displays below.

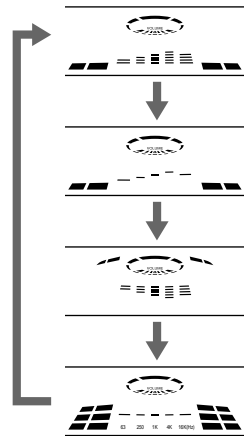

Adjusting the audio emphasis

You can adjust the audio emphasis using the graphic equalizer and surround effect.

6 2 3,4

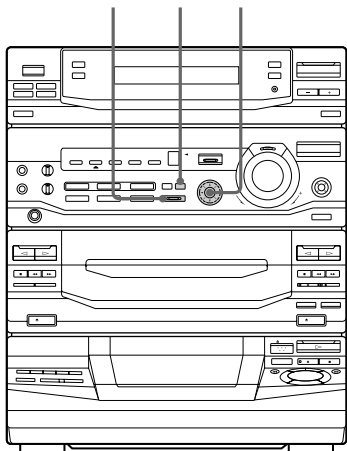

- 4 Press GEQ \uparrow/\downarrow to adjust the level.



- 5 Repeat steps 3 and 4 to adjust the other frequency bands.

- 6 Press ENTER when finished.

Note

If you choose another audio emphasis (other than "EFFECT OFF"), the adjusted sound effect is lost. To retain the adjusted sound effect for future use, store it in a personal file (see "Making a personal audio emphasis file").

Adjusting the graphic equalizer

You can adjust the sound by raising or lowering the levels of specific frequency ranges.

Before operation, first select the basic audio emphasis you want for your sound.

- 1 Select the basic audio emphasis you want for your sound.
(see "Selecting the audio emphasis.")

- 2 Press GEQ CONTROL.
The frequency range appears and the level value flashes in the display.

- 3 Press GEQ \leftarrow/\rightarrow repeatedly to select a frequency band.



Adjusting the Audio Emphasis (continued)

Activating the Surround effect

The Surround Menu lets you select the sound characteristics according to the sound you are listening to.

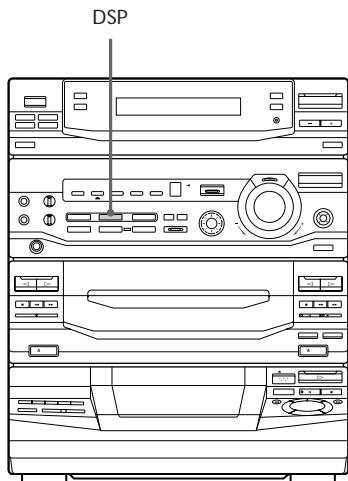

➔ Press DSP (or DSP MODE on the remote) until the desired DSP mode appears in the display.

Each time you press this button, the menu changes as follows:

DSP OFF: Deactivates the DSP mode

HALL: Reproduces the acoustics of a concert hall

THEATER: Reproduces the acoustics of a movie theater

Adjusting the DSP level

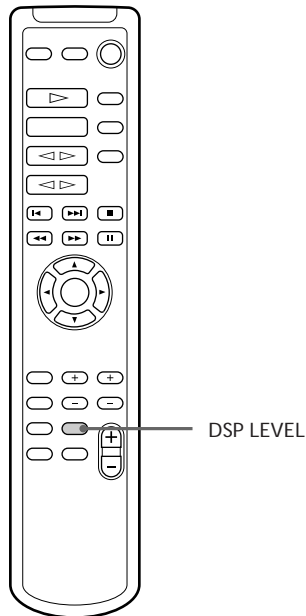

➔ Press DSP LEVEL on the remote to select the DSP level.

Each time you press this button, the level changes as follows:

LEVEL 1 → 2 → 3



Note

- If you choose other sound effects, the surround effect will be canceled. To retain the effect, store it in a personal file (see "Making a personal audio emphasis file").
- You can adjust the DSP level when the DSP mode is activated.

Making a personal audio emphasis file

— Personal File

You can create personal files of audio patterns (surround effect and graphic equalizer) and store them in the unit's memory. Later call up an audio pattern to play a favorite tape, CD, or radio program. You can create up to five audio files. Before operation, first select the basic audio emphasis you want for your sound.

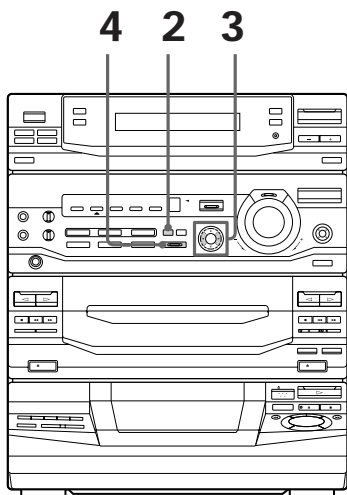

4 Press ENTER.

The adjusted sound effects are stored under the selected file number. Any settings previously stored at this memory location are erased and replaced by the new settings.

To call up the personal file

- 1 Press GEQ $\blacktriangle/\blacktriangledown$ (or MUSIC MENU $\blacktriangle/\blacktriangledown$ on the remote) repeatedly to display the last selected personal file.
- 2 Press GEQ $\blacktriangle/\blacktriangledown$ (or MUSIC MENU $\blacktriangle/\blacktriangledown$ on the remote) repeatedly to select the desired personal file.

-
- 1 Create the sound effect you want by using the graphic equalizer and surround effect (see "Adjusting the audio emphasis").

2 Press P FILE MEMORY.

A personal file number appears in the display.



-
- 3 Press GEQ $\blacktriangle/\blacktriangledown$ to select the file number (P FILE) where you want to store the sound effect.

Enjoying Dolby Pro Logic Surround sound

You can enjoy the Dolby Pro Logic Surround sound of Dolby Surround-encoded (DOLBY SURROUND) videos and TV programs. Complete the setup and speaker adjustments first (see “Step 2: Setting up the speakers”).

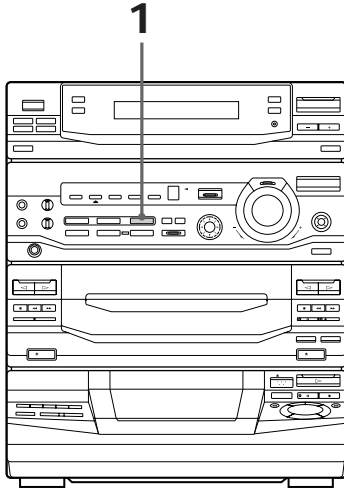

1 Press PRO LOGIC (or PRO LOGIC ON/OFF on the remote) so the indicator on the PRO LOGIC button lights up.

2 Play a program source.

To turn off the Dolby Pro Logic Surround sound

Press PRO LOGIC (or PRO LOGIC ON/OFF on the remote) so the indicator on the PRO LOGIC button goes off.

Notes

- You cannot use the Dolby Pro Logic Surround sound and Surround Menu functions at the same time.
- When you record the sound, turn off the Dolby Pro Logic Surround sound.
- The audio emphasis setting will be canceled when you turn on the Dolby Pro Logic Surround sound.

Singing along: Karaoke

You can sing along with any stereo CD or tape by turning down the singer's voice. You need to connect an optional microphone.

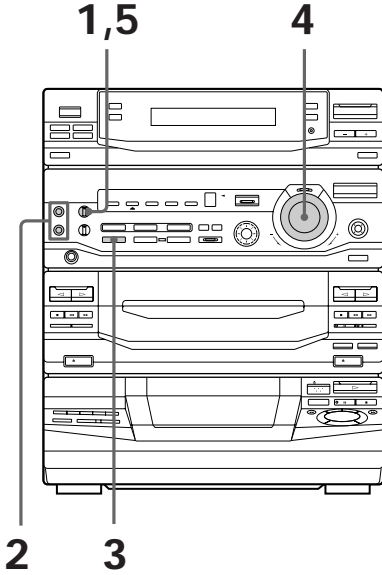

- 1** Turn MIC LEVEL to MIN to turn down the microphone level.

- 2** Connect an optional microphone to the MIC 1 jack.
When you use two microphones at the same time, connect the other one to the MIC 2 jack.

- 3** Press KARAOKE PON/MPX repeatedly to obtain the desired karaoke effect.
Each time you press this button, the display changes as follows:
KARAOKE PON → MPX R → MPX L

↑	←
EFFECT OFF (ON)	

 “” appears in the display when the karaoke mode is activated.

To	Select
Reduce the singer's voice on a CD or tape	KARAOKE PON
Reduce the left channel on a multiplex CD or tape.	MPX R
Reduce the right channel on a multiplex CD or tape.	MPX L

- 4** Start playing the music and adjust the volume.

- 5** Turn MIC LEVEL to adjust the microphone volume.

When you are done

Turn MIC LEVEL to MIN and disconnect the microphone from MIC, then press KARAOKE PON/MPX repeatedly until “” disappears from the display.

Singing along: Karaoke
(continued)

Adjusting the microphone echo

ECHO LEVEL

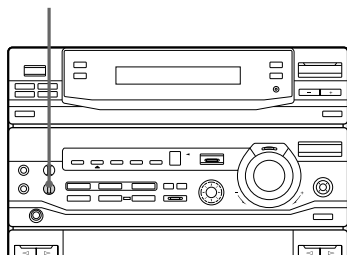

➔ Turn ECHO LEVEL to adjust the echo effect.

To cancel the echoing

Turn ECHO LEVEL to MIN.

Adjusting the key

#/b

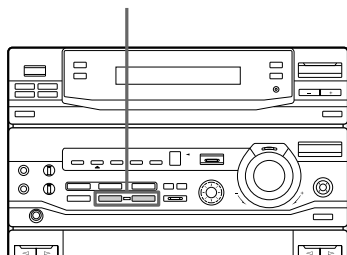

➔ Press **b** or **#**.

You can adjust the key higher or lower in 13 halftone steps (-3.0 to 3.0).

Mixing and recording sounds

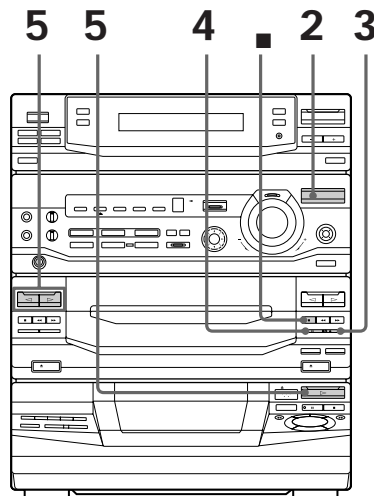

- 1 Prepare the microphone and the karaoke effect. Then, insert a blank tape in deck B.
- 2 Press FUNCTION repeatedly to select the source you desire and set it to pause mode.
- 3 Press ● REC.
- 4 Press II.
- 5 Press ▷ to start playing the CD (or tape in deck A). Playback starts. Start singing along with the music.

To stop recording

Press ■ on deck B.

Waking up to music

— Wake-up Timer

You can wake up to music at a preset time every day. Make sure you have set the clock (see “Step 3: Setting the time”).

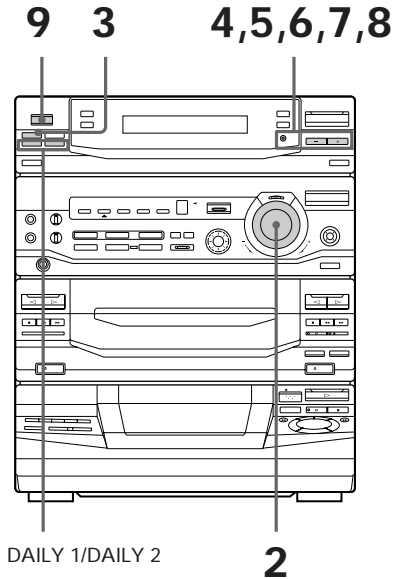

1 Prepare the music source you want to play.

- CD: Insert a CD. To start from a specific track, create a program (see “Programming CD tracks”).
- Tape: Insert a tape with the side you want to play facing forward.
- Radio: Tune in the preset station you want (see “Step 4: Presetting radio stations”).

2 Turn VOLUME to adjust the volume.

3 Press ⊖/CLOCK SET.
“SET” appears and “DAILY 1” flashes in the display.

4 Press TUNING +/- to select DAILY 1 or DAILY 2, then press ENTER/NEXT.

“ON” appears and the hour indication flashes in the display.



5 Set the time to start playing.
Press TUNING +/- to set the hour, then press ENTER/NEXT.
The minutes indication flashes.



Press TUNING +/- to set the minutes, then press ENTER/NEXT.
The hour indication flashes again.

6 Set the time to stop playing following the above procedure.

7 Press TUNING +/- until the music source you want appears.

The indication changes as follows:

TUNER → CD PLAY → TAPE PLAY

8 Press ENTER/NEXT.

The start time, the stop time, and the music source appear in turn before the original display returns.

9 Turn off the system.

To check the setting

- 1 Press the timer button you have set, DAILY 1 or DAILY 2.
- 2 "TIMER OFF" appears in the display.
- 3 Press DAILY 1 or DAILY 2 again.

To cancel the timer operation

- 1 Press the timer button you have set, DAILY 1 or DAILY 2.
- 2 "TIMER OFF" appears in the display.

Notes

- The system turns on 15 seconds before the preset time.
- You cannot activate DAILY 1 and DAILY 2 at the same time.
- You cannot set the timer if the timer on and off times are the same.
- When you set the Sleep Timer, the Wake-up Timer will not turn on the system until the Sleep Timer turns it off.
- You cannot activate the Wake-up Timer and Timer-recording at the same time.

Timer-recording radio programs

To timer-record, you must preset the radio station (see "Step 4: Presetting radio stations") and set the clock (see "Step 3: Setting the time") beforehand.

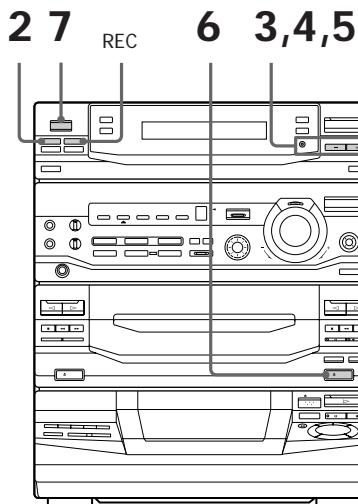

- 1 Tune in the preset radio station (see "Listening to the radio").
- 2 Press \ominus /CLOCK SET.
"SET" appears and "DAILY 1" flashes in the display.
- 3 Press TUNING +/- to select REC, then press ENTER/NEXT.
"ON" appears and the hour indication flashes in the display.



Timer-recording radio programs (continued)

4 Set the time to start recording.

Press TUNING +/- to set the hour, then press ENTER/NEXT.

The minutes indication flashes.



Press TUNING +/- to set the minutes, then press ENTER/NEXT.

The hour indication flashes again.

5 Set the time to stop recording following the above procedure.

The start time, the stop time, the recording source, and the preset station appear in turn before the original display returns.

6 Insert a blank tape in deck B.

7 Turn off the system.

When recording starts, the volume level is set to the minimum.

To check the setting

- 1 Press REC.
- 2 "TIMER OFF" appears in the display.
- 3 Press REC again.

To change the setting, start over from step 1.

To cancel the timer operation

- 1 Press REC.
- 2 "TIMER OFF" appears in the display.

Notes

- The system turns on 15 seconds before the preset time.
- If the system is on at the preset time, the recording will not be made.
- You cannot set the timer if the timer on and off times are the same.
- When you set the Sleep Timer, the Timer-recording will not start until the Sleep Timer turns off the system.
- You cannot activate the Wake-up Timer and Timer-recording at the same time.
- Recording starts from the front side.

Precautions

On operating voltage

Before operating the system, check that the operating voltage of your system is identical with the voltage of your local power supply.

On safety

- The unit is not disconnected from the AC power source (mains) as long as it is connected to the wall outlet, even if the unit itself has been turned off.
- Unplug the system from the wall outlet (mains) if it is not to be used for an extended period of time. To disconnect the cord (mains lead), pull it out by the plug. Never pull the cord itself.
- Should any solid object or liquid fall into the component, unplug the stereo system and have the component checked by qualified personnel before operating it any further.
- The AC power cord must be changed only at the qualified service shop.

On placement

- Place the stereo system in a location with adequate ventilation to prevent heat build-up in the stereo system.
- Do not place the unit in an inclined position.
- Do not place the unit in locations where it is:
 - Extremely hot or cold
 - Dusty or dirty
 - Very humid
 - Vibrating
 - Subject to direct sunlight

On operation

- If the stereo system is brought directly from a cold to a warm location, or is placed in a very damp room, moisture may condense on the lens inside the CD player. Should this occur, the system will not operate properly. Remove the CD and leave the system turned on for about an hour until the moisture evaporates.
- When you move the system, take out any discs.

If you have any questions or problems concerning your stereo system, please consult your nearest Sony dealer.

Notes on CDs

- Before playing, clean the CD with a cleaning cloth. Wipe the CD from the center out.
- Do not use solvents such as benzene, thinner, commercially available cleaners or anti-static spray intended for vinyl LPs.
- Do not expose the CD to direct sunlight or heat sources such as hot air ducts, nor leave it in a car parked in direct sunlight.

Cleaning the cabinet

Use a soft cloth slightly moistened with mild detergent solution.

To save a tape permanently

To prevent a tape from being accidentally recorded over, break off the cassette tab from side A or B as illustrated. If you later want to reuse the tape for recording, cover the broken tab with adhesive tape.

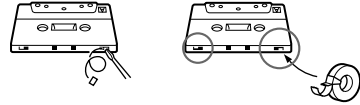

When you are using a TYPE II (CrO₂) or TYPE IV (metal) cassette, be careful not to cover the detector slots which allow the tape player to automatically detect the type of tape.

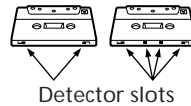

Before placing a cassette in the tape deck

Take up any slack in the tape. Otherwise the tape may get entangled in the parts of the tape deck and become damaged.

When using a tape longer than 90 minutes

The tape is very elastic. Do not change the tape operations such as play, stop, and fast-winding etc. frequently. The tape may get entangled in the tape deck.

Cleaning the tape heads

Clean the tape heads after every 10 hours of use.

When the tape heads become dirty

- the sound is distorted
- there is a decrease in sound level
- the sound drops out
- the tape does not erase completely
- the tape does not record

Make sure to clean the tape heads before you start an important recording or after playing an old tape. Use separately sold dry-type or wet-type cleaning cassette. For details, refer to the instructions of the cleaning cassette.

Demagnetizing the tape heads

Demagnetize the tape heads and the metal parts that have contact with the tape every 20 to 30 hours of use with a separately sold demagnetizing cassette. For details, refer to the instructions of the demagnetizing cassette.

Troubleshooting

If you run into any problem using this stereo system, use the following checklist.

First, check that the power cord is connected firmly and the speakers are connected correctly and firmly.

Should any problem persist, consult your nearest Sony dealer.

General

The display starts flashing as soon as you plug in the power cord even though you haven't turned on the system (demonstration mode).

- Press DISPLAY/DEMO while the system is off.

The demonstration appears automatically the first time you plug in the power cord, or if there is a power outage lasting longer than half a day.

In this case, reset the following:

- Clock setting (see “Step 3: Setting the time”)
- Press DISPLAY/DEMO while the system is off.

There is no sound.

- Turn VOLUME clockwise.
- The headphones are connected.
- Insert only the stripped portion of the speaker cord into the SPEAKER jack. Inserting the vinyl portion of the speaker cord will interfere with the speaker connection.

There is no microphone sound.

- Turn VOLUME or MIC LEVEL to adjust the microphone volume.
- Make sure the microphone is connected to the MIC jack correctly.

There is severe hum or noise.

- A TV or VCR is placed too close to the stereo system. Move the stereo system away from the TV or VCR.

“12:00 AM” flashes in the display.

- A power interruption occurred. Reset the clock and timer settings.

The timer does not function.

- Set the clock correctly.

DAILY 1, DAILY 2, and REC do not appear when you press ☺/CLOCK SET.

- Set the timer correctly.
- Set the clock.

The remote does not function.

- There is an obstacle between the remote and the unit.
- The remote is not pointing in the direction of the system's sensor.
- The batteries have run down. Replace the batteries.

There is acoustic feedback.

- Decrease the volume level.
- Move the microphone away from the speakers or change the direction of the microphone.

The color irregularity on a TV screen persists.

- Turn off the TV set once, then turn it on after 15 to 30 minutes. If the color irregularity still persists, place the speakers farther away from the TV set.

Speakers

Sound comes from only one channel or the left and right volumes are unbalanced.

- Check the speaker connections and speaker placement.

There is no sound from the speakers except the Super Woofer.

- The source being played back is monaural. Press PRO LOGIC to turn off the Pro Logic mode.

There is no sound from the Super Woofer.

- Set the CENTER LEVEL to the appropriate level.
- Set the SUPER WOOFER switch to ON.

There is no sound from the rear speakers.

- Set the REAR LEVEL to the appropriate level.
 - The software being played back has limited sound effects. Check the volume with the test tone.
-

CD Player

The CD tray does not rotate.

- A CD is not placed properly.
-

A CD will not play.

- The CD is not lying flat in the disc tray.
 - The CD is dirty.
 - The CD is inserted label side down.
 - Moisture condensation has built up. Remove the CD and leave the system turned on for about an hour until the moisture evaporates.
-

Play does not start from the first track.

- The player is in Program or Shuffle Play mode. Press PLAY MODE repeatedly until "PROGRAM" or "SHUFFLE" disappear from the display.
-

Tape Deck

The tape does not record.

- No tape is in the cassette holder.
 - The tab has been removed from the cassette (see page 43).
 - The tape has reeled to the end.
-

The tape does not record nor play, or there is a decrease in sound level.

- The heads are dirty. Clean them (see page 43).
 - The record/playback heads are magnetized. Demagnetize them (see page 43).
-

The tape does not erase completely.

- The record/playback heads are magnetized. Demagnetize them (see page 43).
-

There is excessive wow or flutter, or the sound drops out.

- The capstans or pinch rollers are dirty. Clean them (see page 43).
-

Noise increases or the high frequencies are missing.

- The record/playback heads are magnetized. Demagnetize them (see page 43).
-

Tuner

Severe hum or noise ("TUNED" or "STEREO" flashes in the display.

- Adjust the antenna.
 - The signal strength is too weak. Connect an external antenna.
-

A stereo FM program cannot be received in stereo.

- Press STEREO/MONO so "STEREO" appears in the display.
-

If other problems not described above occur, reset the system as follows:

- 1 Unplug the power cord.
- 2 Plug the power cord back in.
- 3 Press SPECTRUM ANALYZER, ENTER, and DISC 1 at the same time.

Specifications

Amplifier section

Peak music power output	2,100 watts
Continuous RMS power output	
FRONT SPEAKER:	100 + 100 watts (8 ohms at 1 kHz, 10% THD)
CENTER SPEAKER:	25 watts (8 ohms at 1kHz, 10% THD)
REAR SPEAKER:	12.5 + 12.5 watts (16 ohms at 1kHz, 10% THD)
SUPER WOOFER:	100 watts (8 ohms at 60Hz, 1% THD)

Inputs

PHONO IN (phono jacks):	sensitivity 3 mV, impedance 47 kilohms
VIDEO (AUDIO) IN (phono jacks):	sensitivity 250 mV, impedance 47 kilohms
MIX MIC (phone jack):	sensitivity 1 mV, impedance 10 kilohms

Outputs

PHONES (stereo phone jack):	accepts headphones of 8 ohms or more
FRONT SPEAKER:	accepts impedance of 8 to 16 ohms
SURROUND SPEAKER CENTER:	accepts impedance of 8 to 16 ohms
SURROUND SPEAKER REAR:	accepts impedance of 16 ohms
SUPER WOOFER:	accepts impedance of 8 to 16 ohms

CD player section

System	Compact disc and digital audio system
Laser	Semiconductor laser ($\lambda = 780$ nm) Emission duration: continuous
Laser output	Max. 44.6 μ W* * This output is the value measured at a distance of 200 mm from the objective lens surface on the Optical Pick-up Block with 7 mm aperture. 780 – 790 nm
Wavelength	780 – 790 nm
Frequency response	2 Hz – 20 kHz (± 0.5 dB)
Signal-to-noise ratio	More than 90 dB
Dynamic range	More than 90 dB

Tape player section

Recording system	4-track 2-channel stereo
Frequency response (DOLBY NR OFF)	60 – 13,000 Hz (± 3 dB), using a Sony TYPE I cassette 60 – 14,000 Hz (± 3 dB), using a Sony TYPE II cassette
Wow and flutter	$\pm 0.15\%$ W. Peak (IEC) 0.1% W. RMS (NAB) $\pm 0.2\%$ W. Peak (DIN)

Tuner section

FM stereo, FM/AM superheterodyne tuner	
FM tuner section	
Tuning range	87.5 – 108.0 MHz (50 kHz step)
Antenna	FM wire antenna
Antenna terminals	75 ohms unbalanced
Intermediate frequency	10.7 MHz
AM tuner section	
Tuning range	531 – 1,602 kHz (with the tuning interval set at 9 kHz) 530 – 1,710 kHz (with the tuning interval set at 10 kHz)
Antenna	AM loop antenna, External antenna terminals
Intermediate frequency	450 kHz

Speakers

SS-SR120	
Speaker system	Full range, bass-reflex type
Speaker unit	10 cm dia., cone type
Rated impedance	16 ohms
Dimensions (w/h/d)	Approx. 175 \times 127 \times 185 mm
Mass	Approx. 1.3 kg net per speaker

General

Power requirements	220 – 240 V AC, 50/60 Hz
Power consumption	350 watts
Dimensions (w/h/d)	Approx. 355 \times 425 \times 435 mm incl. projecting parts and controls
Mass	Approx. 15 kg
Supplied accessories	AM loop antenna (1) Remote RM-SE2AV (1) Sony SUM-3 (NS) batteries (2) FM wire antenna (1) Speaker cords (6) Speaker SS-XB3R (2) Super Woofer (center speaker included) SS-XB8W (1) Rack SU-XB8R (1)
Design and specifications	are subject to change without notice.

Index

A

- Adjusting
 - the audio emphasis 33
 - the sound 31
 - the speaker volume 7
 - the volume 15, 17, 20
- Antennas 5, 13
- Audio emphasis 32, 33
- Automatic Source Selection 15, 17, 20

B

- Batteries 6

C

- CD player 14, 22
- CD Synchro Recording 16
- Clock setting 9
- Connecting. *See* Hooking up

D, E

- Display 5, 22, 32
- Dolby Pro Logic Surround 6, 36
- DSP 34
- Dubbing 21

F, G

- Flash 29

H, I, J

- Hooking up
 - optional components 12
 - the antennas 5, 13
 - the power 5
 - the system 4

K

- Karaoke 37
 - to reduce the vocals (KARAOKE PON) 37
 - to sing along with a multiplex CD or tape (MPX R/MPX L) 37
 - to adjust the key 38
 - to adjust the microphone echo 38

L

- Loop 29

M

- Microphone
 - mixing 38
- Mixing sound 38

N

- Normal Play 14
- Non Stop Play 25

O

- One Touch Play 15, 17, 20

P, Q

- Personal File 35
- Playing
 - a CD 14
 - a preset radio station 17
 - a tape 19
 - tracks in random order (Shuffle Play) 23
 - tracks in the desired order (Program Play) 24
 - tracks repeatedly (Repeat Play) 22
 - without interruption 25
- Presetting radio stations 10
- Preset tuning 17
- Program Edit 27
- Program Play 24
- Protecting recordings 43

R

- Radio stations
 - presetting 10
 - tuning in 17
- Recording
 - a CD 16
 - a radio program 18
 - a tape manually 26
 - another tape 21
 - CDs by specifying the track order 27
 - selecting tape length automatically 28
 - timer recording 41
- Repeat Play 22
- Resetting the system 45

S

- Saving recordings 43
- Setting the time 9
- Shuffle Play 23
- Sleep Timer 39
- Sound adjustment 31
- Speakers 5, 6
- Surround effect 32
- Surround menu 34

T, U, V

- Tape Select Edit 28
- Test tone 7
- Timer
 - falling asleep to music 39
 - timer recording 41
 - waking up to music 40
- Troubleshooting 44
- Tuner 10, 17, 18
- Tuning interval 11
- Turntable 12

W, X, Y, Z

- Wake-up timer 40
- Wave 29

