

# *Compact Component Stereo System*

---

Operating Instructions



*CMT-ED1/ED1A*

## WARNING

To prevent fire or shock hazard, do not expose the unit to rain or moisture.

To avoid electrical shock, do not open the cabinet. Refer servicing to qualified personnel only.

Do not install the appliance in a confined space, such as a bookcase or built-in cabinet.

Laser component in this product is capable of emitting radiation exceeding the limit for Class 1.

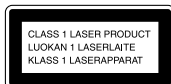

This appliance is classified as a CLASS 1 LASER product. The CLASS 1 LASER PRODUCT MARKING is located on the rear exterior.

This caution label is located inside the unit.



This stereo system is equipped with the Dolby\* B-type noise reduction system.

\* Dolby noise reduction manufactured under license from Dolby Laboratories Licensing Corporation. "DOLBY" and the double-D symbol  are trademarks of the Dolby Laboratories Licensing Corporation.

---

# Table of Contents

---

## Getting Started

Step 1: Hooking up the system .....	4
Step 2: Setting the time .....	7
Step 3: Presetting radio stations .....	8
Connecting optional AV components .....	10

## Basic Operations

Playing a CD .....	12
Recording a CD .....	14
Listening to the radio .....	15
Recording from the radio .....	16
Playing a tape .....	18

---

## The CD Player

Using the CD display .....	19
Playing CD tracks repeatedly .....	19
Playing CD tracks in random order .....	20
Programming CD tracks .....	21

---

## The Tape Deck

Recording on a tape manually .....	22
Recording CD by specifying the track order .....	23

---

## Sound Adjustment

Activating the bass sound .....	25
Activating the sound effect .....	25

---

## Other Features

Falling asleep to music .....	26
Waking up to music .....	26
Timer-recording radio programmes..	28

---

## Additional Information

Precautions .....	30
Troubleshooting .....	31
Specifications .....	33
Index .....	34

## Step 1: Hooking up the system

Follow steps **1** through **5** to hook up your system using the supplied cords and accessories.

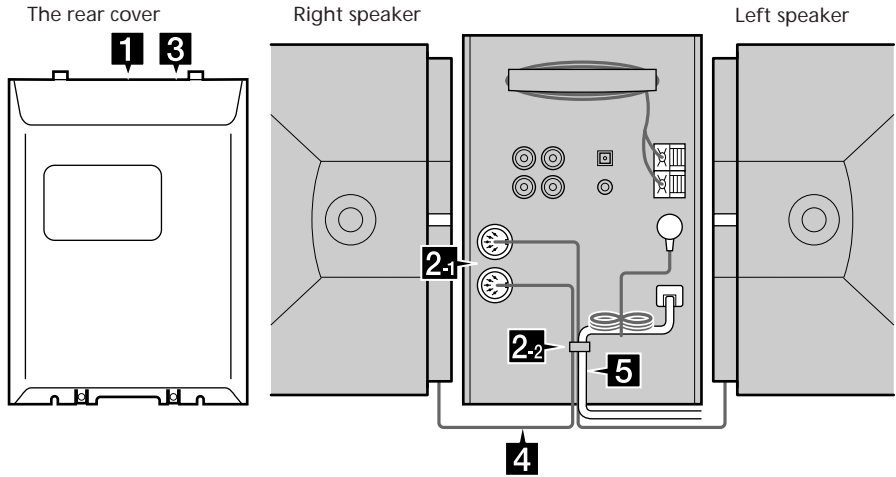

### **1** Remove the rear cover.

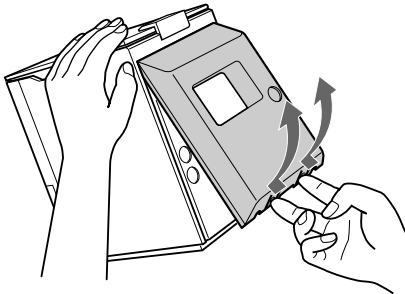

Push in on the tabs and pull up on the cover.

### **2** Connect the speakers.

- 1 Connect the speaker cords to the SPEAKER R jack and the SPEAKER L jack on the rear panel of the unit.

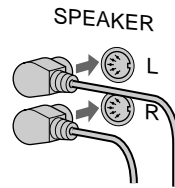

- 2 Attach the speaker cables to the clump.

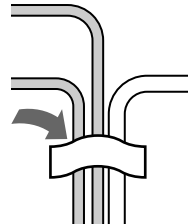

### 3 Attach the speakers.

Facing the front of the unit, attach the speaker connected to the SPEAKER R jack onto the right side of the unit and the speaker connected to the SPEAKER L jack onto the left side of the unit.

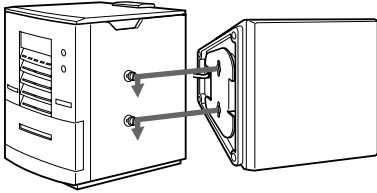

### 3 Reinstall the rear cover.

Put the wires through the hole at the bottom of the rear cover.

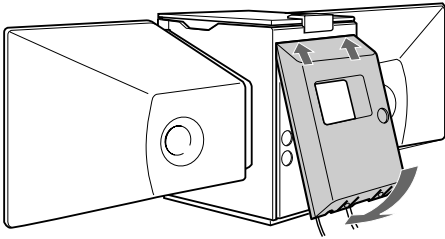

### 4 Turn the unit upside down holding the glass door with firm hand and set the speaker cord into a groove of the unit.

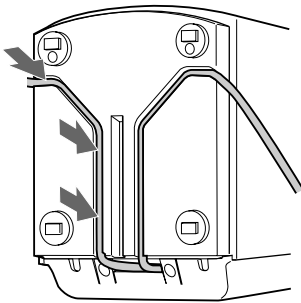

### 5 Connect the mains lead to mains.

#### Note on the glass door of CD player

The CD player cover of the CMT-ED1 is made of tempered glass.

Under normal conditions, this tempered glass is more shock resistant and able to bear more weight than ordinary glass. This glass, however, may shatter if it receives a sharp blow or if it is scratched.

#### To detach the speakers

- 1 Slide the speakers in the opposite direction of the arrows of the illustration in "Attach the speakers" (see step 2 -3 on this page.)
- 2 After detaching the speakers, set the speaker cords into the speaker cord groove at the bottom of the speaker. Otherwise, the speaker cord could be damaged.

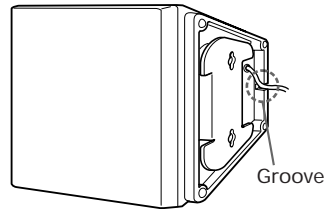

## Step 1: Hooking up the system (continued)

### To remove the AM aerial

If noise is heard while listening to an AM station, remove the AM aerial from the rear panel and place the aerial outside the cabinet.

- 1 Remove the rear cover.  
(See step **1** on the page 4.)
- 2 Remove the AM aerial.

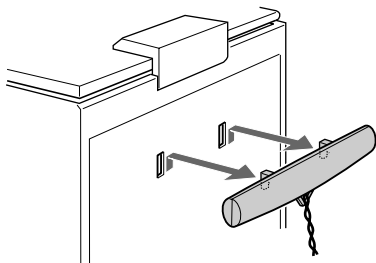

- 3 Attach the rear cover.  
(See step **3** on the page 5.)

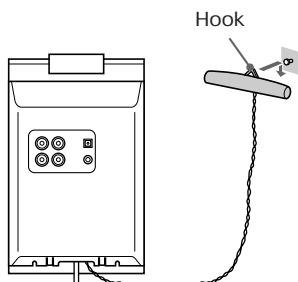

You can hang the AM aerial on a wall.

If noise is heard while listening to an FM station, remove the FM aerial from the rear panel and place the aerial outside the cabinet.

### To exchange the speaker net

You can remove the speaker net drawing up to your side and exchange with the supplied extra net.

### Tip

See wire dressing for the rear panel prior to install the rear cover.

## Inserting two AA (R6) batteries into the remote

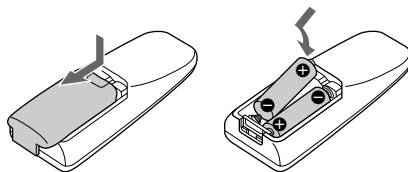

### Tip

With normal use, the batteries should last for about six months. When the remote no longer operates the system, replace both batteries with new ones.

### Note

If you do not use the remote for a long period of time, remove the batteries to avoid possible damage from battery leakage.

## Step 2: Setting the time

You must set the time before using the timer functions.

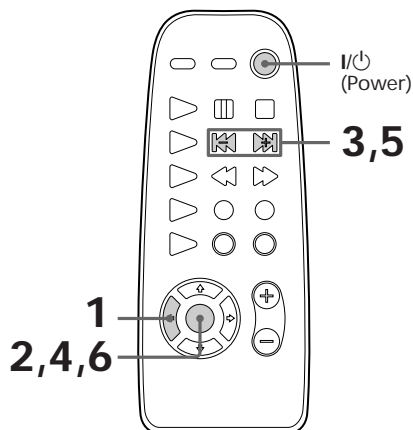

- 4 Press ENTER.  
The minute indication flashes.



- 5 Press ◀◀/▶▶ to set the minutes.

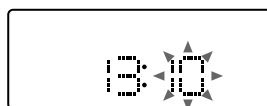

- 6 Press ENTER.  
The clock starts working.

**Tip**  
If you make a mistake, start over from step 1.

- 1 Press **TIMER SET**.  
The clock of the display begins flashes.  
When "DAILY" or "TIMER REC" appears, press ◀◀/▶▶ repeatedly so that it disappears.



- 2 Press ENTER.  
The hour indication flashes.



- 3 Press ◀◀/▶▶ to set the hour.  
The clock uses the 24 -hour system.



# Step 3: Presetting radio stations

You can preset up to 30 stations, 20 for FM and 10 for AM.

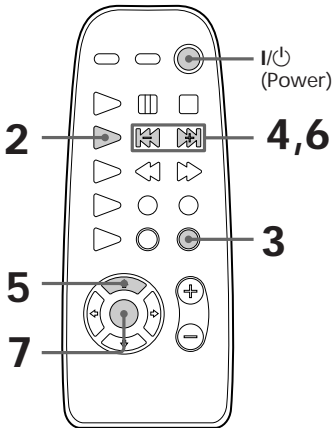
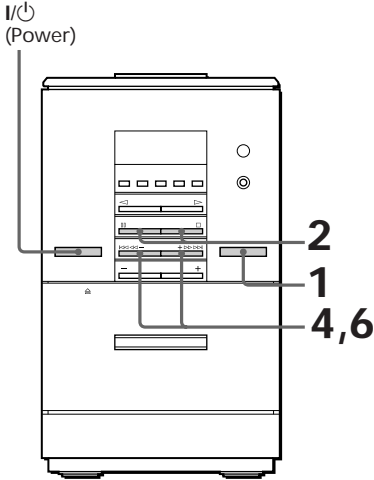

- 1 Press FUNCTION repeatedly to select "FM" or "AM."
- 2 Press FM or AM (or TUNER/BAND on the remote repeatedly).
- 3 Press TUNING/PLAY MODE on the remote repeatedly until "AUTO" appears.
- 4 Press TUNING +/- (or ⏪/⏩ on the remote).  
The frequency indication changes and scanning stops when the system tunes in a station. "TUNED" and "ST" (for a stereo programme) appears.

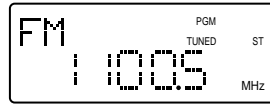

- 5 Press MEMORY on the remote. The preset channel number flashes.



- 6 Press TUNING +/- (or ⏪/⏩ on the remote) to select the preset number you want.



- 7 Press ENTER on the remote. The station is stored.
- 8 Repeat steps 4 through 7 to store other stations.



**To tune in a station with a weak signal**

Press TUNING/PLAY MODE on the remote repeatedly until "MANUAL" appears in step 3, then press TUNING +/- (or  $\lll/\ggg$ ) on the remote) to tune in the station.

**To change the preset number**

Start over from step 2.

**Tip**

The preset stations are retained for about two days when you disconnect the mains lead or a power failure occurs.

# Connecting optional AV components

To enhance your system, you can connect optional components. Refer to the instructions included with each component for details.

## Connecting audio components

### Connecting an MD deck for analog recording

Be sure to match the colour of the plugs and the connectors. To listen to the sound from the connected MD deck, press FUNCTION repeatedly until "MD" appears.

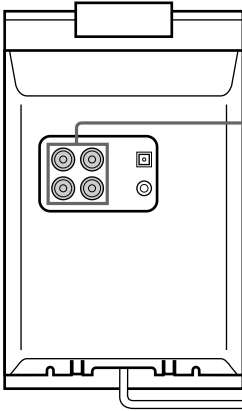

To the audio input/output of the MD deck

### Connecting an MD deck for digital recording

You can record from CD into the MD deck digitally by connecting an optical cable.

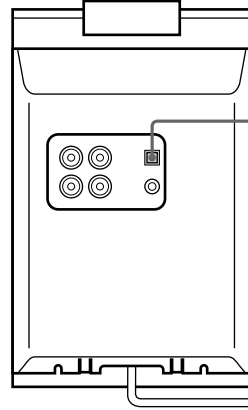

To the digital input of the MD deck

### Connecting a VCR

Be sure to match the colour of the plugs and the connectors. To listen to the sound from the connected VCR, press FUNCTION repeatedly until "MD" appears.

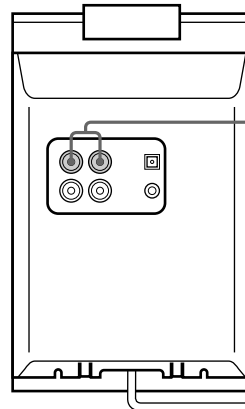

To the audio output of the VCR

## Connecting the headphones

Connect the headphones to the PHONES jack.

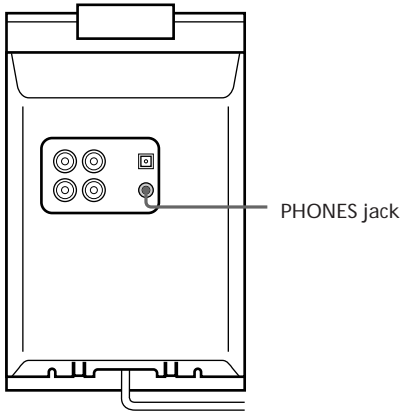

## AM aerial

Connect a 6 to 15 meter insulated wire to the AM aerial terminal. Leave the supplied AM bar aerial connected.

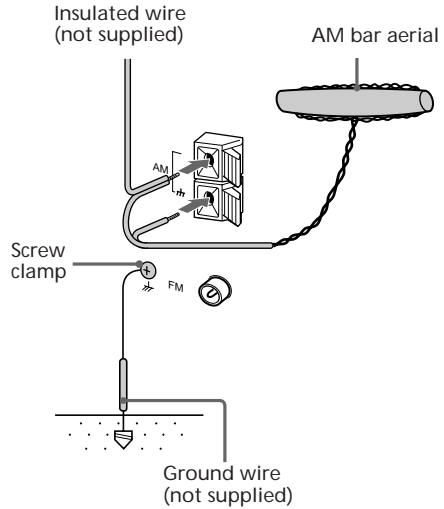

## Connecting outdoor aerials

Remove the rear cover and connect an outdoor aerial to improve the reception.

### FM aerial

Connect an optional FM outdoor aerial using a 75-ohm coaxial cable and IEC standard socket connector. You can also use the TV aerial instead.

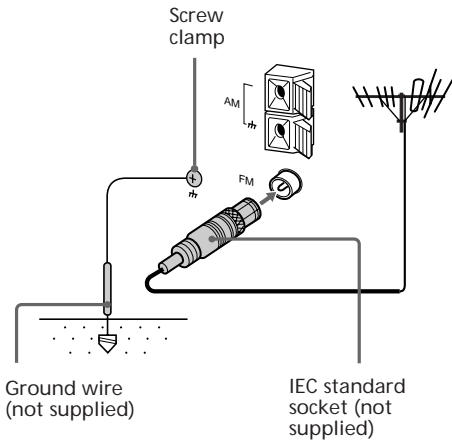

## Important

If you connect an outdoor aerial, connect a ground wire to the FM terminal with the screw clamp. To prevent a gas explosion, do not connect the ground wire to a gas pipe.

## Playing a CD

### — Normal Play

You can play all tracks in the original order consecutively.

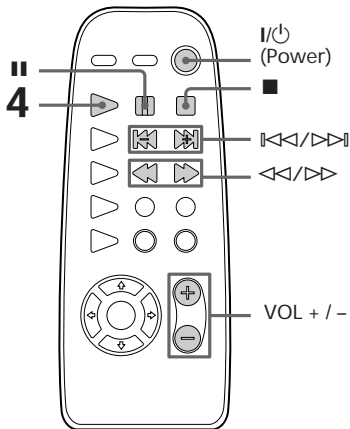
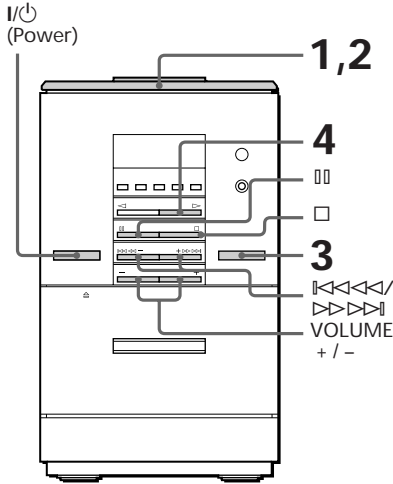

- 1 Open the glass door and place a CD on the disc tray.  
Open the glass door.  
The display will show "OPEn".  
Fit the CD to the pivot and place the stabilizer on the CD with the hole facing down.

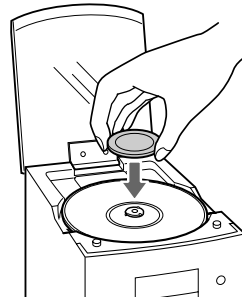
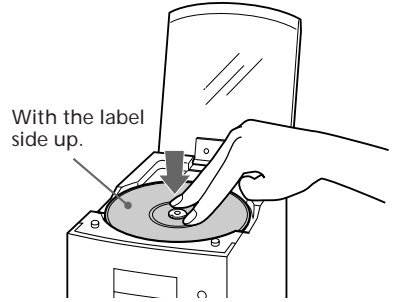

- 2 Close the glass door.
- 3 Press FUNCTION repeatedly until "CD" appears.
- 4 Press ▷ (or CD ▷ on the remote). Playback starts.

Track number Elapsed time

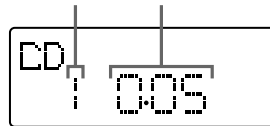

To	Do this
Stop playback	Press □.
Pause	Press ⏸. Press again to resume playback.
Select a track	During playback or pause, press ⏩⏩⏩⏩ (or ⏩⏩ on the remote)(to go forward) or ⏪⏪⏪⏪ (or ⏪⏪ on the remote)(to go backward).
Find a point in a track	Press and hold ⏩⏩⏩⏩ (or ⏩⏩ on the remote) or ⏪⏪⏪⏪ (or ⏪⏪ on the remote) during playback, and release at the desired point.
Remove the CD	Open the glass door.
Adjust the volume	Press VOLUME +/- (or VOL +/- on the remote).

### To remove the CD

Remove the stabilizer and pick up the disc holding the edge, while pressing the pivot gently as illustrated.

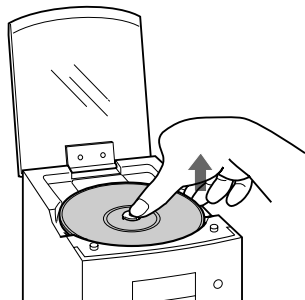

### Tips

- Pressing CD⏩ on the remote while the power is off automatically turns the power on and starts CD playback if there is a CD on the tray (One Touch Play).
- You can switch from another source to the CD just pressing CD⏩ on the remote (Automatic Source Selection).
- If there is no CD in the player, “no dISC” appears.

# Recording a CD

## — CD Synchro Recording

This function lets you record from a CD to a tape easily. You can use TYPE I (normal) or TYPE II (CrO<sub>2</sub>) tapes.

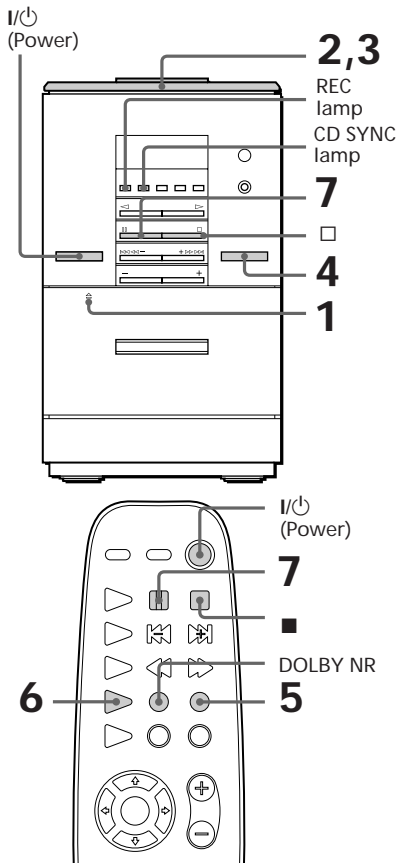

**2** Open the glass door and place a CD (see page 12).

**3** Close the glass door.

**4** Press FUNCTION repeatedly until "CD" appears.

**5** Press ● REC on the remote. The deck stands by for recording, and the CD SYNC and REC lamps on the unit light up red.

**6** Press DIR MODE on the remote repeatedly to select ⇐ to record on one side or ⇔ to record on both sides.

**7** Press □ . Recording starts from the front side. After about 10 seconds, the CD starts playing.

### To stop recording

Press □.

### Tips

- When you insert a new tape, the CD starts playing after 10 seconds.
- When you want to reduce the hiss noise in low-level high-frequency signals, press DOLBY NR on the remote before step 7 so "□□" appears.

### Notes

- You cannot listen to other sources while recording.
- You cannot record from the reverse side.

**1** Press ≡ PUSH of the front cover and insert a blank tape into the deck.

With the side you want to record on facing forward

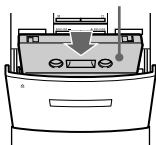

# Listening to the radio

## — Preset Tuning

Before using this function, preset radio stations in the tuner's memory (see "Step 3: Presetting radio stations").

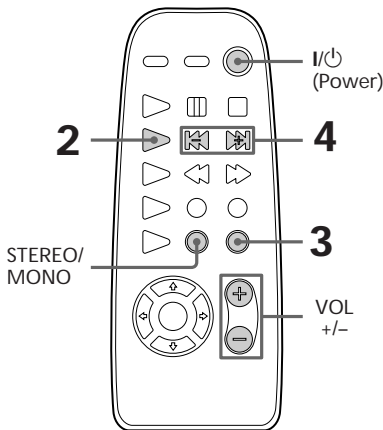
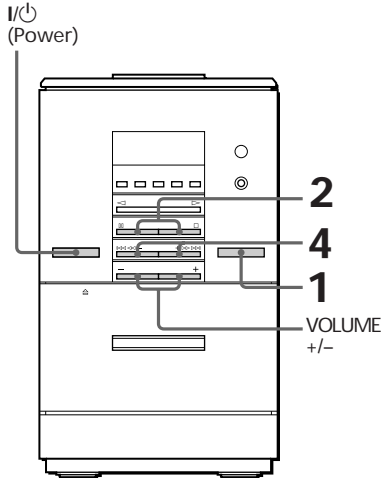

- 1 Press FUNCTION repeatedly until "FM" or "AM" appears.
- 2 Press FM or AM (or TUNER/BAND on the remote repeatedly).

- 3 Press TUNING/PLAY MODE on the remote repeatedly until "PRESET" appears.

- 4 Press TUNING +/- (or  $\lll/\ggg$ ) on the remote to tune in the desired preset station.

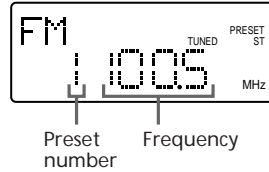

To	Do this
Turn off the radio	Press I/⏻.
Adjust the volume	Press VOLUME +/- (or VOL +/- on the remote).

## To listen to non-preset radio stations

Press TUNING/PLAY MODE on the remote repeatedly in step 3 until "MANUAL" appears, then press TUNING +/- (or  $\lll/\ggg$ ) on the remote to tune in the desired station.

### Tips

- Pressing TUNER/BAND on the remote while the power is off automatically turns on the power and tunes to the last received station (One Touch Play).
- You can switch from another source to the radio just by pressing TUNER/BAND on the remote (Automatic Source Selection).
- If an FM programme is noisy, press STEREO/MONO on the remote repeatedly until "MONO" appears. There will be no stereo effect, but the reception will improve. Press this button again to restore the stereo effect.
- To improve broadcast reception, remove the rear cover and put the aerial out of the cabinet (see "To remove the AM aerial" on page 6).

# Recording from the radio

You can record a radio programme on a tape by tuning in a preset station. You can use TYPE I (normal) or TYPE II (CrO<sub>2</sub>) tapes.

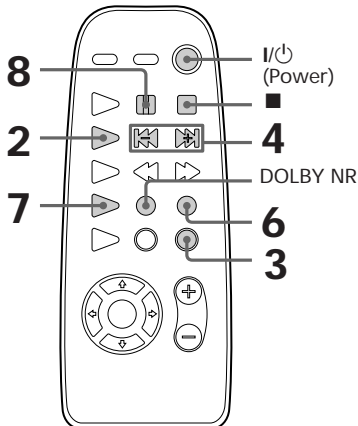
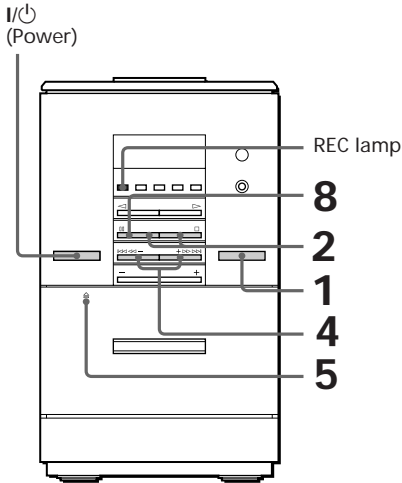

- 1 Press FUNCTION repeatedly until “FM” or “AM” appears.
- 2 Press FM or AM (or TUNER/BAND on the remote repeatedly).
- 3 Press TUNING/PLAY MODE on the remote repeatedly until “PRESET” appears.
- 4 Press TUNING +/- (or ◀▶) on the remote) to tune in a preset station.

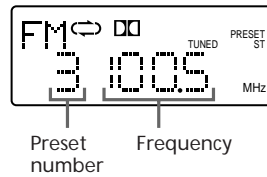

- 5 Press PUSH of the front cover and insert a blank tape into the deck.

With the side you want to record on facing forward

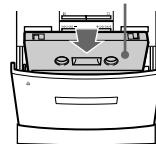

- 6 Press ● REC on the remote. The deck stands by for recording, and the REC lamp on the unit lights up red.
- 7 Press DIR MODE on the remote repeatedly to select ◀▶ to record on one side or ↔ to record on both sides.

- 8 Press □□. Recording starts from the front side.

## To stop recording

Press □.



**Tips**

- To record non-preset stations, select “MANUAL” in step 3, then press TUNING +/- (or  $\lll/\ggg$  on the remote) to tune in the desired station.
- When you want to reduce the hiss noise in low-level high-frequency signals, press DOLBY NR on the remote before step 8 so “NR” appears.
- If noise is heard while recording from the radio, remove the aerial and put the aerial out of the cabinet (see “To remove the AM aerial” on page 6) to reduce the noise.

**Note**

You cannot record from the reverse side.

# Playing a tape

You can play any type of tape, TYPE I (normal), TYPE II (CrO<sub>2</sub>) or TYPE IV (metal). The deck automatically detects the tape type.

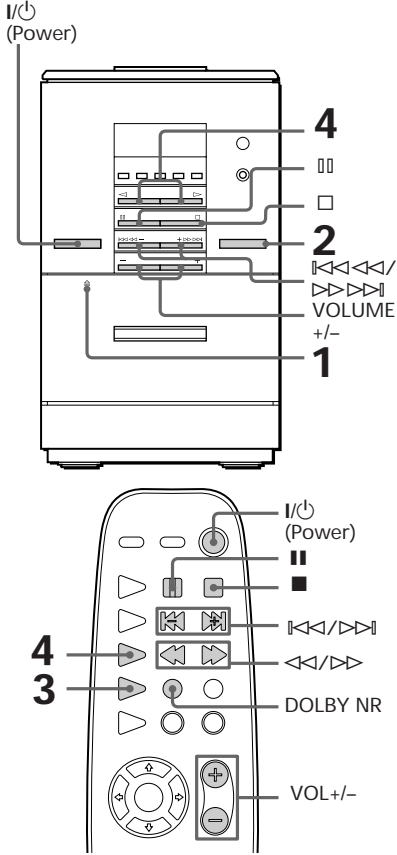

- 1 Press **⇨** PUSH of the front cover and insert a recorded tape into the deck.

With the side you want to play facing forward

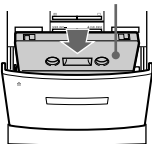

- 2 Press **FUNCTION** repeatedly until "TC" appears.
- 3 Press **DIR MODE** on the remote repeatedly to select **⇨** to play one side or **⇩⇨**\* to play both sides.
- 4 Press **▷** (or **TAPE <◁▷** on the remote).  
Press **◁** (or **TAPE <◁▷** on the remote again) to play the reverse side. The tape starts playback.

\* The deck stops automatically after playback both sides five times.

To	Do this
Stop play	Press <b>□</b> .
Pause	Press <b>⏸</b> . Press again to resume playback.
Fast-forward or rewind	During stop, press <b>▷▷▷▷</b> or <b>◁◁◁◁</b> (or <b>&lt;◁/▷</b> on the remote).
Find the beginning of the current or succeeding track	During playback, press <b>◁◁◁◁</b> or <b>±</b> (or <b>◁◁/▷▷</b> on the remote).
Remove the cassette	Press <b>⇨</b> PUSH.
Adjust the volume	Press <b>VOLUME +/-</b> (or <b>VOL +/-</b> on the remote).

## Tips

- Pressing **TAPE <◁▷** on the remote while the power is off automatically turns on the power and starts tape playback if there is a tape in the deck (One Touch Play).
- You can switch from another source to the tape deck just by pressing **TAPE <◁▷** on the remote (Automatic Source Selection).
- When you want to reduce the hiss noise in low-level high-frequency signals, press **DOLBY NR** on the remote before step 4 so "TC" appears.

## Using the CD display

You can check the remaining time of the current track or the whole CD.

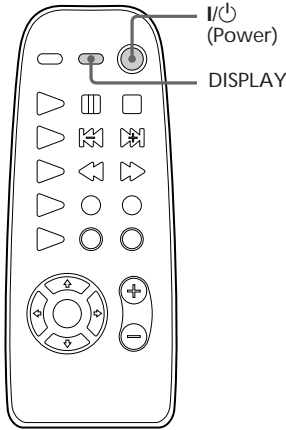

- ➔ Press **DISPLAY** on the remote. Each time you press this button in Normal Play, the display changes as follows:

### During playback

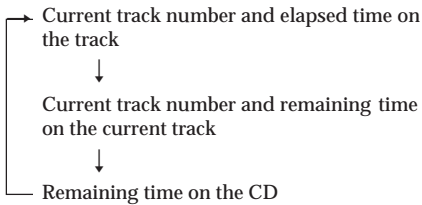

### During stop

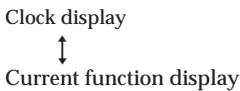

## Playing CD tracks repeatedly

### — Repeat Play

This function lets you repeat a CD in Normal Play, Shuffle Play, and Programme Play.

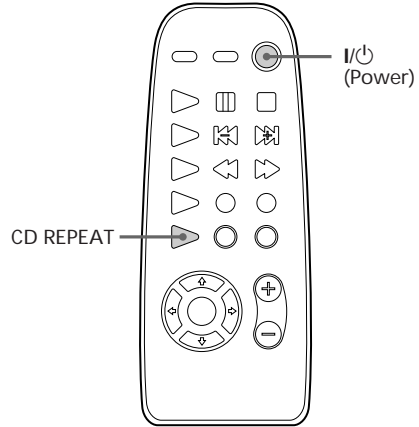

- ➔ Press **CD REPEAT** on the remote repeatedly until “REPEAT” appears. Repeat Play starts. The following table describes the various repeat modes.

To repeat	Press
All the tracks on the CD	CD REPEAT repeatedly until “REPEAT” appears.
Only one track*	CD REPEAT repeatedly while playing the track you want to repeat until “REPEAT 1” appears.

\* You cannot repeat a single track during Shuffle Play and Programme Play.

### To cancel Repeat Play

Press **CD REPEAT** repeatedly until “REPEAT” or “REPEAT 1” disappears.

# Playing CD tracks in random order

## — Shuffle Play

You can play all the tracks on one CD in random order.

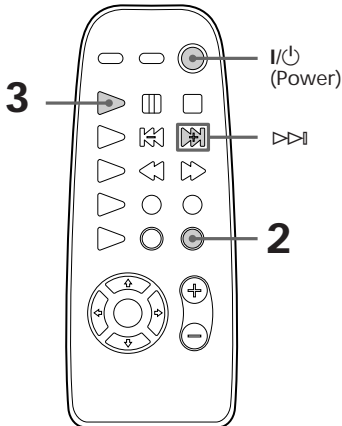
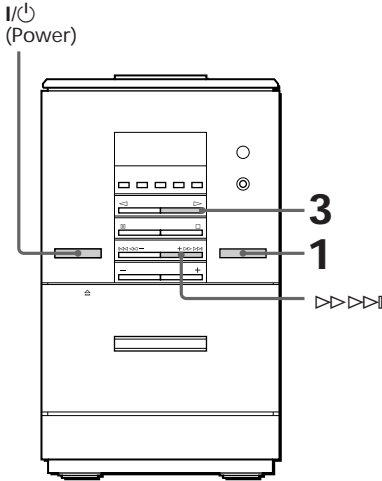

---

**1** Press FUNCTION repeatedly until “CD” appears.

---

**2** Press TUNING/PLAY MODE on the remote repeatedly until “SHUFFLE” appears.

---

**3** Press  $\blacktriangleright$  (or CD  $\blacktriangleright$  on the remote). “ $\text{E}_3$ ” appears and all the tracks play in random order.

---

### To cancel Shuffle Play

Press TUNING/PLAY MODE on the remote repeatedly until “SHUFFLE” disappears from the display. The tracks continue playing in their original order.

### Tips

- If you press TUNING/PLAY MODE repeatedly until “SHUFFLE” appears during normal play, you can play all the tracks on the CD in random order.
- To skip a track, press  $\blacktriangleright\blacktriangleright\blacktriangleright$  (or  $\blacktriangleright$  on the remote).
- You cannot go back to the preceding track by pressing  $\blacktriangleleft\blacktriangleleft\blacktriangleleft$  (or  $\blacktriangleleft$  on the remote).

# Programming CD tracks

## — Programme Play

You can create a programme of up to 24 tracks from the CD in the order you want them to be played.

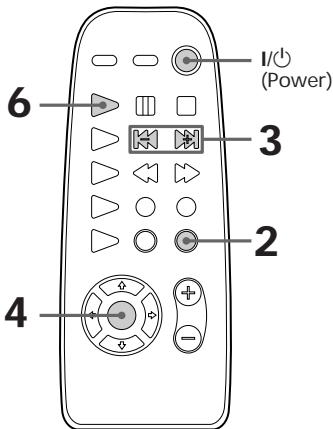
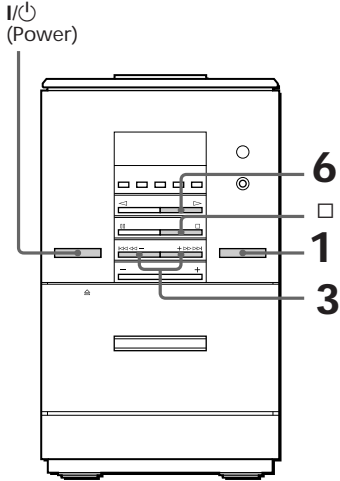

**1** Press **FUNCTION** repeatedly until “CD” appears.

**2** Press **TUNING/PLAY MODE** on the remote repeatedly until “PGM” appears.

**3** Press **⏮⏮⏮** or **⏭⏭⏭** (or **⏮** or **⏭** on the remote) until the desired track appears.

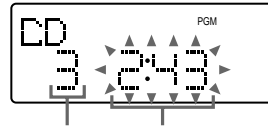

Track number    Total playing time

**4** Press **ENTER** on the remote. The program number appears for about a second, and the total playing time lights up.

**5** To programme additional tracks, repeat steps 3 and 4 to programme the remaining tracks you want to play in the order you want them to play.

**6** Press **▷** (or **CD ▷** on the remote). All the tracks play in the order you selected.

## To cancel Programme Play

Press **TUNING/PLAY MODE** on the remote repeatedly until “PGM” disappears from the display.

To	Do this
Add a track to the end of the programme	During stop, do steps 3 and 4.
Clear the entire programme	Press <b>□</b> on the player during stop.

## Tips

- The programme you created remains in the CD player’s memory until you turn off the power or remove a CD. Press **▷** to play the same programme again.
- If the total playing time has exceeded 100 minutes, the order of the programme is displayed instead of the total playing time.
- If you try to programme more than 24 tracks, “FULL” appears in the display.

## Recording On a tape manually

You can record tracks from CD, radio, or the connected component as you like. For example, you can record just the songs you want or record from the middle of the CD.

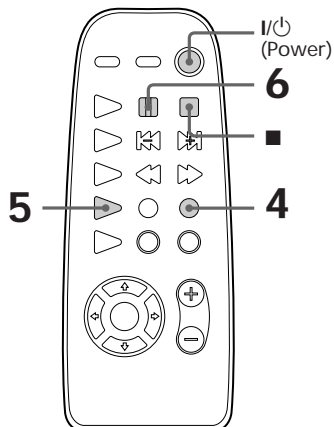
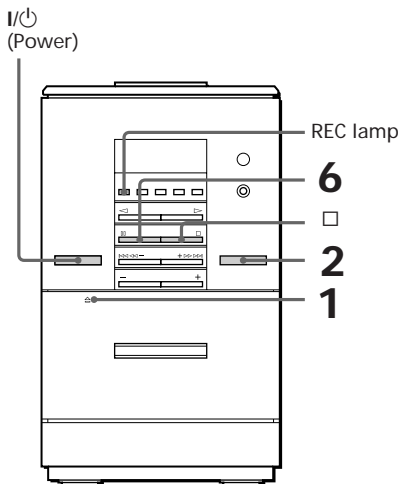

- 1** Insert a blank tape into the deck.
- 2** Press FUNCTION repeatedly until the source you want to record (e.g., CD) appears.
- 3** Start playing the source to be recorded.
- 4** Press ● REC on the remote.  
The deck stands by for recording and the REC lamp on the unit lights up red.
- 5** Press DIR MODE on the remote repeatedly to select ⇐⇒ to record on one side or ⇔ to record on both sides.
- 6** Press ■■.  
Recording starts from the front side.

To	Press
Stop recording	□. Press □ again to stop playing the CD.
Pause recording	■■.

### Tips

- When you want to reduce the hiss noise in low-level high-frequency signals, press DOLBY NR on the remote before step 6 so "■■" appears.
- When you press ●REC during stop of the CD, CD synchro recording starts (see "Recording a CD" on the page 14).

# Recording CD by specifying the track order

## — Programme Edit

You can record tracks from the CD in the order you want. When programming, make sure the playing times for each side do not exceed the length of one side of the tape.

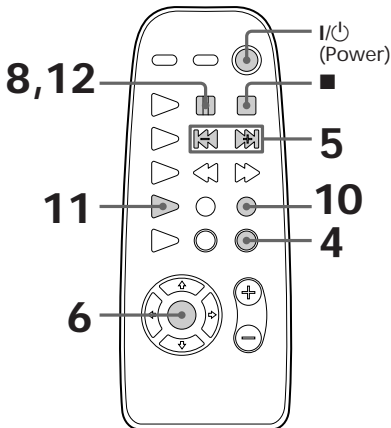
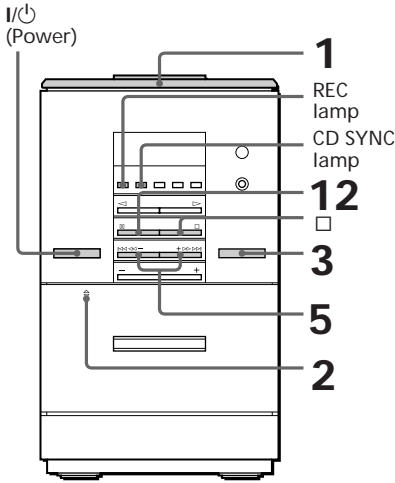

- 1 Place a CD and close the glass door.
- 2 Insert a blank tape into the deck.
- 3 Press FUNCTION repeatedly until "CD" appears.
- 4 Press TUNING/PLAY MODE on the remote repeatedly until "PGM" appears.
- 5 Press <<<<<< or >>>>>> (or <<</>>> on the remote) until the desired track appears.

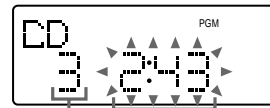

Track number Total playing time (including selected track)

- 6 Press ENTER on the remote.
- 7 Repeat steps 5 and 6 to programme additional tracks to be recorded on side A in the order you want them to be recorded.
- 8 Press [ ] on the remote to insert a pause at the end of side A.
- 9 Repeat steps 5 and 6 to programme the tracks to be recorded on side B.
- 10 Press ● REC on the remote.

The deck stands by for recording and the CD SYNC and REC lamps on the unit light up red.

## ***Recording CD by specifying the track order (continued)***

---

**11** Press DIR MODE on the remote repeatedly to select  $\rightleftarrows$  to record on one side or  $\leftrightarrow$  to record on both sides.

---

**12** Press  $\square$ .  
Recording starts from the front side.  
After about 10 seconds, the CD starts playing.

---

### **To stop recording**

Press  $\square$ .

### **To cancel Programme Edit**

Press TUNING/PLAY MODE on the remote repeatedly until "PGM" disappears from the display.



## Activating the bass sound

You can reinforce the bass to create a more powerful sound.

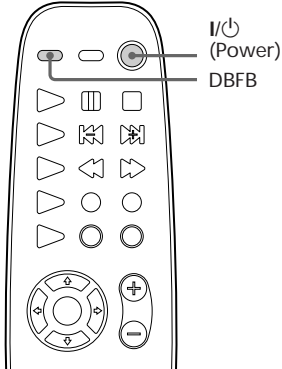
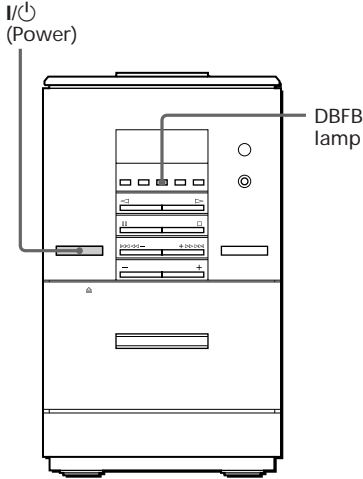

- ➔ Press DBFB\* on the remote. The DBFB lamp on the unit lights up red.

\* DBFB = Dynamic Bass Feedback

### To cancel DBFB

Press DBFB again.  
The DBFB lamp on the unit turns off.

## Activating the sound effect

You can adjust the sound according to your taste or room situation.

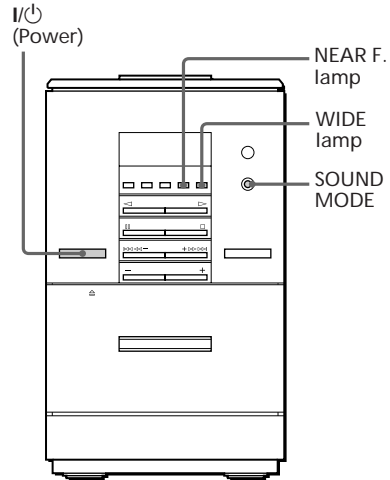

- ➔ Press SOUND MODE.

Each time you press this button, the following LED lamp lights up red.  
NEAR F. → WIDE → LED off

When you select	You can
NEAR F.	Create simulated stereo surround effects for background music.
WIDE	Spread the sound all around the room.
LED off	Return to the normal stereo sound.

## Falling asleep to music

### — Sleep Timer

You can set the system to turn off at a preset time, so you can fall asleep listening to music. You can preset the remaining time in 10 minute increments.

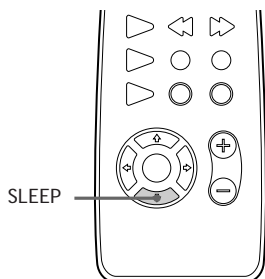

#### → Press SLEEP.

Each time you press this button, the minutes display (the remaining time) changes as follows:

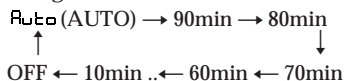

### When you choose AUTO

The power turns off when the current CD or tape finishes playback (up to 100 minutes). The power turns off if you manually stop playing a CD or tape.

### To check the remaining time

Press SLEEP once.

### To change the remaining time

Press SLEEP repeatedly to select the time you want.

### To cancel the Sleep Timer function

Press SLEEP repeatedly until "SLEEP" disappears.

## Waking up to music

### — Daily Timer

You can wake up to music at a preset time every day. Make sure you have set the clock (see "Step 2: Setting the time").

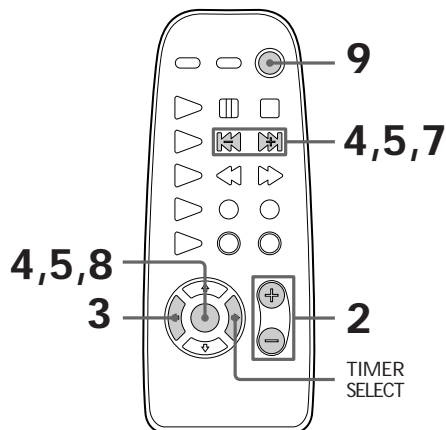
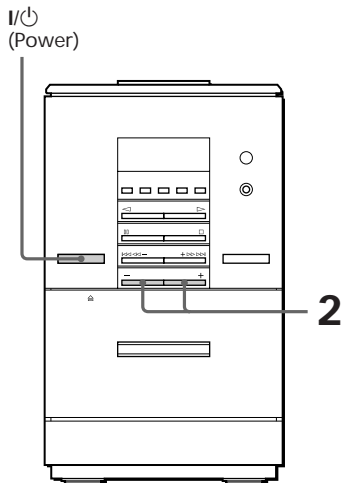

- 
- 1** Prepare the music source you want to play.
- CD: Insert a CD. To start from a specific track, create a programme (see “Programming CD tracks”).
  - Tape: Insert a tape with the side you want to play facing forward.
  - Radio: Tune in the preset station you want (see “Step 3: Presetting radio stations”).
- 

**2** Press VOLUME +/- (or VOL +/- on the remote) to adjust the volume.

---

**3** Press TIMER SET on the remote.

---

**4** Press ◀◀ or ▶▶ to display “DAILY”, and then press ENTER on the remote.  
“ON” appears and the hour indication flashes.



---

**5** Set the time to start playing.  
Press ◀◀ or ▶▶ to set the hour, then press ENTER on the remote.  
The minutes indication flashes.

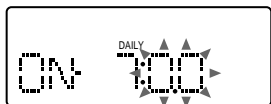

---

**6** Set the time to stop playing following the above procedure.

---

**7** Press ◀◀ or ▶▶ until the music source you want appears.  
The indication changes as follows:  
CD → FM/AM → TC → MD



---

**8** Press ENTER on the remote.  
The start time, the stop time, and the music source appear in turn before the original display returns.

---

**9** Turn off the power.

---

### To check the setting

Press TIMER SELECT on the remote repeatedly until “DAILY” and “TIMER REC” disappear, then press TIMER SELECT again.

The preset items appear sequentially.

### To cancel the timer operation

Press TIMER SELECT on the remote repeatedly until “OFF” appears.

### Notes

- The system turns on 15 seconds before the preset time.
- You cannot set the timer if the timer on and off times are the same.
- When you set the Sleep Timer, the Daily Timer will not turn on the system until the Sleep Timer turns it off.
- You cannot activate the Daily Timer and Timer-recording at the same time.

# Timer-recording radio programmes

## — REC Timer

To timer-record, you must preset the radio station (see “Step 3: Presetting radio stations”) and set the clock (see “Step 2: Setting the time”) beforehand.

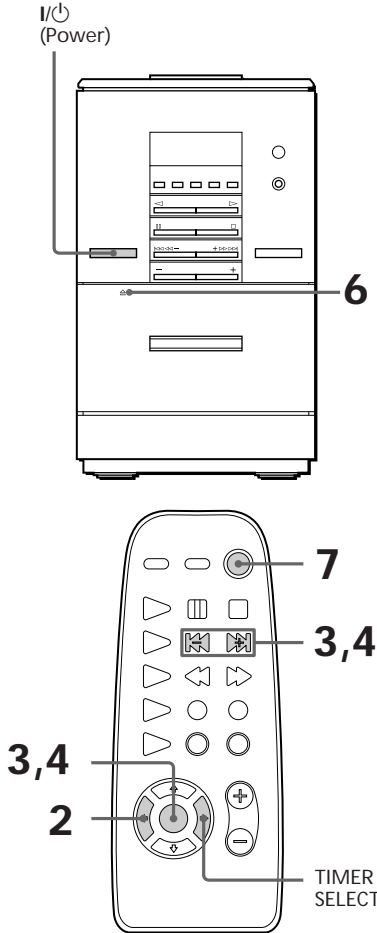

**1** Tune in the preset radio station you want to record (see “Listening to the radio”).

**2** Press **TIMER SET** on the remote.

**3** Press **◀◀** or **▶▶** on the remote to select **TIMER REC**, then press **ENTER**.  
“ON” appears and the hour indication flashes.

**4** Set the time you want to start recording.

Press **◀◀** or **▶▶** on the remote to set the hour, and press **ENTER**.  
The minutes indication flashes.



Set the minute in the same way, and press **ENTER**.

The hour indication for the turn-off time flashes.



**5** Set the time to stop recording following the above procedure.

The start time, the stop time, the recording source, and the preset station appear in turn before the original display returns.

**6** Insert a blank tape into deck.

**7** Turn off the power.

When recording starts, the volume level is set to the minimum.

### **To check the setting**

Press TIMER SELECT on the remote so that "TIMER REC" disappears, then press TIMER SELECT repeatedly until "TIMER REC" appears.

The preset items appear sequentially.

### **To cancel the timer operation**

Press TIMER SELECT on the remote repeatedly until "OFF" appears.

### **To set the timer with the same items**

Press TIMER SELECT on the remote repeatedly until "TIMER REC" appears, and press I/⏻ to turn off the system. Once you set the timer, you do not have to set the same items again.

### **Notes**

- The system turns on 15 seconds before the preset time.
- If the power is on at the preset time, the recording will not be made.
- You cannot set the timer if the timer on and off times are the same.
- When you set the Sleep Timer, the Rec Timer will not start until the Sleep Timer turns off the system.
- You cannot activate the Daily Timer and Rec Timer at the same time.
- Recording starts from the front side.

## Precautions

### On operating voltage

Before operating the system, check that the operating voltage of your system is identical with the voltage of your local power supply.

### On safety

- The unit is not disconnected from the AC power source (mains) as long as it is connected to the wall outlet, even if the unit itself has been turned off.
- Unplug the system from the wall outlet (mains) if it is not to be used for an extended period of time. To disconnect the cord (mains lead), pull it out by the plug. Never pull the cord itself.
- Should any solid object or liquid fall into the component, unplug the stereo system and have the component checked by qualified personnel before operating it any further.
- The AC power cord must be changed only at the qualified service shop.

### On placement

- Place the stereo system in a location with adequate ventilation to prevent heat build-up in the stereo system.
- Do not place the unit in an inclined position.
- Do not place the unit in locations where it is;
  - Extremely hot or cold
  - Dusty or dirty
  - Very humid
  - Vibrating
  - Subject to direct sunlight

### On operation

- If the stereo system is brought directly from a cold to a warm location, or is placed in a very damp room, moisture may condense on the lens inside the CD player. Should this occur, the system will not operate properly. Remove the CD and leave the system turned on for about an hour until the moisture evaporates.
- When you move the system, take out any discs.

If you have any questions or problems concerning your stereo system, please consult your nearest Sony dealer.

### Notes on CDs

- Before playing, clean the CD with a cleaning cloth. Wipe the CD from the centre out.
- Do not use solvents such as benzene, thinner, commercially available cleaners or antistatic spray intended for vinyl LPs.
- Do not expose the CD to direct sunlight or heat sources such as hot air ducts, nor leave it in a car parked in direct sunlight.

### Cleaning the cabinet

Use a soft cloth slightly moistened with mild detergent solution.

### To save a tape permanently

To prevent a tape from being accidentally recorded over, break off the cassette tab from side A or B as illustrated. If you later want to reuse the tape for recording, cover the broken tab with adhesive tape.

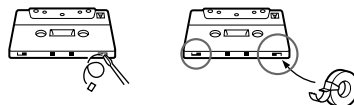

When you are using a TYPE II (CrO<sub>2</sub>) or TYPE IV (metal) cassette, be careful not to cover the detector slots which allow the tape player to automatically detect the type of tape.

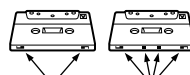

Detector slots

### Before placing a cassette in the tape deck

Take up any slack in the tape. Otherwise the tape may get entangled in the parts of the tape deck and become damaged.

### When using a tape longer than 90 minutes

The tape is very elastic. Do not change the tape operations such as play, stop, and fast-winding etc. frequently. The tape may get entangled in the tape deck.

### Cleaning the tape heads

Clean the tape heads after every 10 hours of use.

When the tape heads become dirty

- the sound is distorted
- there is a decrease in sound level
- the sound drops out
- the tape does not erase completely
- the tape does not record

Make sure to clean the tape heads before you start an important recording or after playing an old tape. Use separately sold dry-type or wet-type cleaning cassette. For details, refer to the instructions of the cleaning cassette.

### Demagnetising the tape heads

Demagnetise the tape heads and the metal parts that have contact with the tape every 20 to 30 hours of use with a separately sold demagnetising cassette. For details, refer to the instructions of the demagnetising cassette.

---

# Troubleshooting

If you run into any problem using this stereo system, use the following check list.

First, check that the mains lead is connected firmly and the speakers are connected correctly and firmly.

Should any problem persist, consult your nearest Sony dealer.

---

## General

**There is no sound.**

- Press VOLUME +/-.
- The headphones are connected.

**There is severe hum or noise.**

- A TV or VCR is placed too close to the stereo system. Move the stereo system away from the TV or VCR.

**"0:00" flashes in the display.**

- A power interruption occurred. Reset the clock and timer settings.

**The timer does not function.**

- Set the clock correctly.

**DAILY and TIMER REC do not appear when you press TIMER SET.**

- Set the timer correctly.
- Set the clock.

**The remote does not function.**

- There is an obstacle between the remote and the unit.
- The remote is not pointing in the direction of the system's sensor.
- The batteries have run down. Replace the batteries.

**The colour irregularity on a TV screen persists.**

- Place the speakers farther away from the TV set.

---

## Speakers

**Sound comes from only one channel or the left and right volumes are unbalanced.**

- Check the speaker connections and placement.

---

## CD Player

**A CD will not play.**

- The CD is dirty.
- The CD is inserted label side down.
- Moisture condensation has built up. Remove the CD and leave the system turned on for about an hour until the moisture evaporates.

**Play does not start from the first track.**

- The player is in Programme or Shuffle Play mode. Press TUNING/PLAY MODE on the remote repeatedly until "PROGRAM" or "SHUFFLE" disappears.

---

## Tape Deck

**The tape does not record.**

- No tape is in the cassette holder.
- The tab has been removed from the cassette (see page 30).
- The tape has reeled to the end.

**The tape does not record nor play, or there is a decrease in sound level.**

- The heads are dirty. Clean them (see page 30).
- The record/playback heads are magnetised. Demagnetise them (see page 30).

**The tape does not erase completely.**

- The record/playback heads are magnetised. Demagnetise them (see page 30).

**There is excessive wow or flutter, or the sound drops out.**

- The capstans or pinch rollers are dirty. Clean them (see page 30).

**Noise increases or the high frequencies are missing.**

- The record/playback heads are magnetised. Demagnetise them (see page 30).

## Tuner

---

Severe hum or noise ("TUNED" or "ST" flashes).

- Adjust the aerial.
  - The signal strength is too weak. Connect an external aerial.
- 

A stereo FM programme cannot be received in stereo.

- Press STEREO/MONO on the remote so that "ST" appears in the display.
- 

**If other problems not described above occur, reset the system as follows:**

- 1 Unplug the mains lead.
- 2 Plug the mains lead back in while pressing I/⏻.

Set the clock, timer setting and preset radio stations again.



# Specifications

## Amplifier section

DIN power output	15 + 15 watts (6 ohms at 1 kHz, DIN)
Continuous RMS power output	17 + 17 watts (4 ohms at 1 kHz, 10% THD)
Music power output:	22 + 22 watts
Inputs	
MD IN (phono jacks):	sensitivity 450 mV, impedance 47 kilohms

Outputs	
MD OUT (phono jacks):	sensitivity 250 mV, impedance 1 kilohm
PHONES (stereo phone jack):	accepts headphones of 8 ohms or more
SPEAKER:	active speaker system, 4 ohms

## CD player section

System	Compact disc and digital audio system
Laser	Semiconductor laser ( $\lambda = 780$ nm) Emission duration: continuous
Laser output	Max. $44.6 \mu\text{W}^*$ * This output is the value measured at a distance of 200 mm from the objective lens surface on the Optical Pick-up Block with 7 mm aperture.
Wavelength	780 – 790 nm
Frequency response	2 Hz – 20 kHz ( $\pm 0.5$ dB)
Signal-to-noise ratio	More than 90 dB
Dynamic range	More than 90 dB

## Tape player section

Recording system	4-track 2-channel stereo
Frequency response (DOLBY NR OFF)	50 – 13,000 Hz ( $\pm 3$ dB), using a Sony TYPE I cassette 50 – 14,000 Hz ( $\pm 3$ dB), using a Sony TYPE II cassette
Wow and flutter	$\pm 0.15\%$ W. Peak (IEC) $0.1\%$ W. RMS (NAB) $\pm 0.2\%$ W. Peak (DIN)

## Tuner section

FM stereo, FM/AM superheterodyne tuner

### FM tuner section

Tuning range	87.5 – 108.0 MHz (50 kHz step)
Aerial	FM wire aerial
Aerial terminals	75 ohm unbalanced
Intermediate frequency	10.7 MHz

### AM tuner section

Tuning range	531 – 1,602 kHz (with the tuning interval set at 9 kHz)
Aerial	AM bar aerial, External aerial terminal
Intermediate frequency	450 kHz

## Speakers

Speaker system	Full range, active MFB
Speaker units:	10 cm dia., cone type
Rated impedance	4 ohms
Dimensions (w/h/d)	Approx. $195 \times 205 \times 120$ mm ( $7 \frac{3}{4} \times 8 \frac{1}{8} \times 4 \frac{3}{4}$ in)
Mass	Approx. 1.5 kg (3 lb 7 oz.) net per speaker

## General

Power requirements	230 V AC, 50/60 Hz
Power consumption	60 watts
Dimensions (w/h/d)	Approx. $127 \times 212 \times 184$ mm ( $5 \times 8 \frac{3}{8} \times 7 \frac{1}{4}$ in) incl. projecting parts and controls
Mass	Approx. 3.6 kg (7 lb 15 oz)
Supplied accessories	AM bar aerial (1) Remote RM-SED1 (1) Stabilizer (1) Batteries (2) FM wire aerial (1) Speaker grille net (1) Speaker mounting screws(4)
Optional accessories	Wall hanging bracket WHB-ED1 Speaker saran net SSN-ED1 Stand SU-ED1

Design and specifications are subject to change  
without notice.

---

# Index

## A

- Activating
  - the bass sound 25
  - the sound effect 25
- Adjusting
  - the volume 13, 15, 18
- Aerials 11
- Automatic Source Selection 13, 15, 18

## B

- Batteries 6

## C

- CD player 12, 19
- Clock setting 7
- Connecting. *See* Hooking up

## D, E

- Display 19

## F, G, H, I, J

- Hooking up
  - optional components 10
  - the aerials 11
  - the power 5
  - the system 4

## K, L, M, N

- Normal Play 12

## O

- One Touch Play 13, 15, 18

## P, Q

- Playing
  - a CD 12
  - a preset radio station 15
  - a tape 18
  - tracks in random order (Shuffle Play) 20
  - tracks in the desired order (Programme Play) 21
  - tracks repeatedly (Repeat Play) 19
- Presetting radio stations 8
- Preset tuning 15
- Programme Edit 23
- Programme Play 21
- Protecting recordings 30

## R

- Radio stations
  - presetting 8
  - tuning in 15
- Recording
  - a CD 14
  - a radio programme 16
  - a tape manually 22
  - CDs by specifying the track order 23
  - timer recording 28
- Repeat Play 19
- Resetting the system 32

## S

- Saving recordings 30
- Setting the time 7
- Shuffle Play 20
- Sleep Timer 26
- Sound effect 25
- Speakers 4
- Stabilizer 12

## T, U, V

- Timer
  - falling asleep to music 26
  - timer recording 28
  - waking up to music 26
- Troubleshooting 31
- Tuner 8, 15, 16

## W, X, Y, Z

- Wake-up timer 26



