



# *CD/DVD Player*

---

Operating Instructions \_\_\_\_\_ EN

XXXXXXXXXXXXXXXXX \_\_\_\_\_ C



*DVP-S3000*

## WARNING

To prevent fire or shock hazard, do not expose the unit to rain or moisture. To avoid electrical shock, do not open the cabinet. Refer servicing to qualified personnel only.

Mains cord must only be changed at qualified service shop.

### CAUTION

The use of optical instruments with this product will increase eye hazard. As the laser beam used in this CD/DVD Player is harmful to eyes, do not attempt to disassemble the cabinet.

Refer servicing to qualified personnel only.



This label is located on the Laser protective housing inside the enclosure.

## Precautions

### Safety

- This unit operates on 220 - 240 V AC, 50 Hz. Check that the unit's operating voltage is identical with your local power supply.
- If anything falls into the cabinet, unplug the unit and have it checked by qualified personnel before operating it any further.
- The unit is not disconnected from the mains as long as it is connected to the mains outlet, even if the unit itself has been turned off.
- Unplug the unit from the wall outlet if you do not intend to use it for an extended period of time. To disconnect the cord, pull it out by the plug, never by the cord.

### Installing

- Allow adequate air circulation to prevent internal heat buildup.
- Do not place the unit on surfaces (rugs, blankets, etc.) or near materials (curtains, draperies) that may block the ventilation slots.
- Do not install the unit near heat sources such as radiators or air ducts, or in a place subject to direct sunlight, excessive dust, mechanical vibration or shock.
- Do not install the unit in an inclined position. It is designed to be operated in a horizontal position only.
- Keep the unit and discs away from equipment with strong magnets, such as microwave ovens or large loudspeakers.
- Do not place heavy objects on the unit.
- If the unit is brought directly from a cold to a warm location, moisture may condense inside the CD/DVD player and cause damage to the lenses. When you first install the unit, or when you move it from a cold to a warm location, wait for about one hour before operating the unit.

---

## Welcome!

Thank you for purchasing the Sony CD/DVD Player. Before operating the unit, please read this manual thoroughly and retain it for future reference.

# TABLE OF CONTENTS

---

This Player Can Play the Following Discs .....	4
--	---

---

<b>Getting Started</b>	
Unpacking .....	6
Hooking Up the System .....	6
Necessary Setup Before Using the Player .....	9

---

<b>Basic Operations</b>	
<b>Playing a DVD</b> .....	10
<b>Playing a VIDEO CD</b> .....	18
<b>Playing a CD</b> .....	26

---

<b>Playing Discs in Various Modes</b>	
Playing Repeatedly (Repeat Play) .....	32
Playing in Random Order (Shuffle Play) .....	34
Creating Your Own Program (Program Play) .....	34
Resuming Playback from the Point Where You Stopped a Disc (Resume Play) .....	36
Reducing the Picture Noise (DNR) .....	37
Changing the Sounds .....	37
Turning the Sub-titles On and Off .....	38
Changing the Sub-titles .....	38
Changing the Angles .....	39
Controlling the TV with the Supplied Remote .....	39

---

<b>Settings and Adjustments</b>	
Using the Menu .....	40
Settings for Playback (PLAY MODE) .....	41
Adjustments for Playback Picture (VIDEO CONTROL) .....	41
Settings for Display and Sound (CUSTOM SETUP) .....	42
Basic Settings (INITIAL SETUP) .....	43

---

<b>Additional Information</b>	
Precautions .....	45
Notes on Discs .....	45
Troubleshooting .....	46
Specifications .....	47
Glossary .....	48
Index to Parts and Controls .....	49
Language Code List .....	52

---





<b>Index</b> .....	53
--------------------	----

# About This Manual



The instructions in this manual are for model DVP-S3000.

## Conventions

- Instructions in this manual describe the controls on the player.  
You can also use the controls on the remote if they have the same or similar names as those on the player.
- The icons on the right are used in this manual:

Icon	Meaning
	Indicates that you can use only the remote to do the task.
	Indicates tips and hints for making the task easier.
	Indicates the functions for DVD VIDEOS.
	Indicates the functions for VIDEO CDs.
	Indicates the functions for AUDIO CDs.

# This Player Can Play the Following Discs

	DVD VIDEOS		VIDEO CDs		AUDIO CDs	
Disc logo						
Contents	Audio + Video		Audio + Video		Audio	
Disc size	12 cm	8 cm	12 cm	8 cm	12 cm	8 cm (CD single)
Play time	About 4 h (for single-sided DVD)/ about 8 h (for double-sided DVD)	About 80 min. (for single-sided DVD)/ about 160 min. (for double-sided DVD)	74 min.	20 min.	74 min.	20 min.
Reference pages for basic operations	Pages 10 to 17		Pages 18 to 25		Pages 26 to 31	

“DVD VIDEO” logo is a trademark.

This player conforms to the DVD VIDEOS recorded in the NTSC color system and the VIDEO CDs in the NTSC and PAL color systems. (For details, see page 9.)

## Region code of DVDs you can play

Region code indications such as  are labeled on some DVDs to indicate which type of player can play the discs.

Unless “6” is included in the indications or  is labeled on the DVDs, you cannot play the discs on this player. If you try to play these DVDs, the message “PLAYING THIS DISC PROHIBITED BY AREA LIMITS” will appear on the TV screen.

Depending on the DVD, no region code indication may be labeled even though playing the DVD is prohibited by the area limits.

### Note on playback operations of DVDs and VIDEO CDs

Some playback operations of DVDs and VIDEO CDs may be intentionally fixed by software producers. Since this player plays DVDs and VIDEO CDs according to the disc contents the software producers designed, some playback features may not be available. Also refer to the instructions supplied with the DVDs or VIDEO CDs.

**Terms for discs**

- **Title**  
The longest sections of a picture or a music piece on a DVD; a movie, etc. for a picture piece on a video software or an album, etc. for a music piece on an audio software. Each title is assigned a title number enabling you to locate the title you want.
- **Chapter**  
Sections of a picture or a music piece that are smaller than titles. A title is composed of several chapters. Each chapter is assigned a chapter number enabling you to locate the chapter you want. Depending on the disc, no chapter may be recorded.
- **Track**  
Sections of a picture or a music piece on a VIDEO CD or a CD. Each track is assigned a track number enabling you to locate the track you want.

Some of the DVD software include special encoding to trigger copy protection signal from the NTSC output of this player. If you find noise on playback picture of a certain DVD software, there is a possibility that it is caused by the incompatibility between your display and the copy protection signals triggered by such encoding in the DVD software.

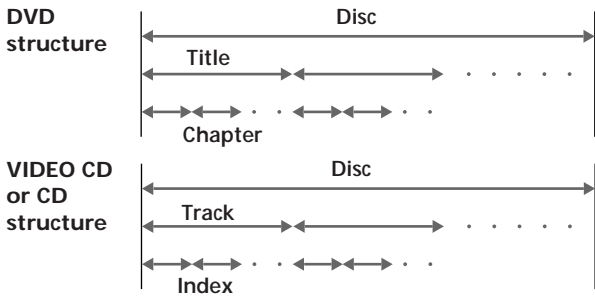

- **Index**  
A number that divides a track into some sections to easily locate the point you want on a VIDEO CD or a CD. Depending on the disc, no index may be recorded.
- **Scene**  
On a VIDEO CD with PBC functions, the menu screens, moving pictures and still pictures are divided into sections called "scenes." Each scene is assigned a scene number enabling you to locate the scene you want.

**Note on PBC (Playback Control) (VIDEO CDs)**

This player conforms to Ver. 1.1 and Ver. 2.0 of VIDEO CD standards. You can enjoy two kinds of playback according to the disc type.

Disc type	You can
VIDEO CDs without PBC functions (Ver. 1.1 discs)	Enjoy video playback (moving pictures) as well as music.
VIDEO CDs with PBC functions (Ver. 2.0 discs)	Play interactive software using menu screens displayed on the TV screen (PBC Playback), in addition to the video playback functions of Ver 1.1 discs. Moreover, you can play high-resolution still pictures, if they are included on the disc.

**Discs that the player cannot play**

The player cannot play discs other than the ones listed in the table on page 4 such as CD-ROMs including PHOTO CDs, data sections in CD-EXTRAS and DVD-ROMs.

This product incorporates copyright protection technology that is protected by method claims of certain U.S. patents and other intellectual property rights owned by Macrovision Corporation and other rights owners. Use of this copyright protection technology must be authorized by Macrovision Corporation, and is intended for home and other limited viewing uses only unless otherwise authorized by Macrovision Corporation. Reverse engineering or disassembly is prohibited.

## Unpacking



Check that you have the following items:

- Audio/video connecting cord (1)
- S video cable (1)
- Remote commander (remote) RMT-D100E (1)
- Sony R6 (size AA) batteries (2)

## Inserting batteries into the remote

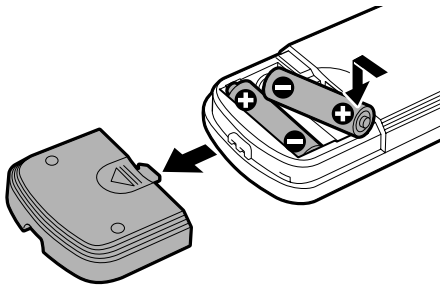
You can control the player using the supplied remote. Insert two R6 (size AA) batteries by matching the + and - on the batteries. When using the remote, point it at the remote sensor  on the player.



 You can control Sony TVs with the  mark using the supplied remote  
See page 39.

 **When to replace batteries**  
With normal use, the batteries should last for about six months. When the remote no longer operates the player, replace all the batteries with new ones.

### Notes

- Do not leave the remote in an extremely hot or humid place.
- Do not drop any foreign object into the remote casing, particularly when replacing the batteries.
- Do not expose the remote sensor to direct sunlight or lighting apparatuses. Doing so may cause a malfunction.
- If you will not use the remote for an extended period of time, remove the batteries to avoid possible damage from battery leakage and corrosion.

## Hooking Up the System

### Overview

This section describes how to hook up the CD/DVD player to a TV (with audio/video input jacks) and/or an amplifier. You cannot connect this player to a TV without a video input connector. **Be sure to turn off the power of each component before making the connections.**

#### ■ To listen to the sound through TV speakers

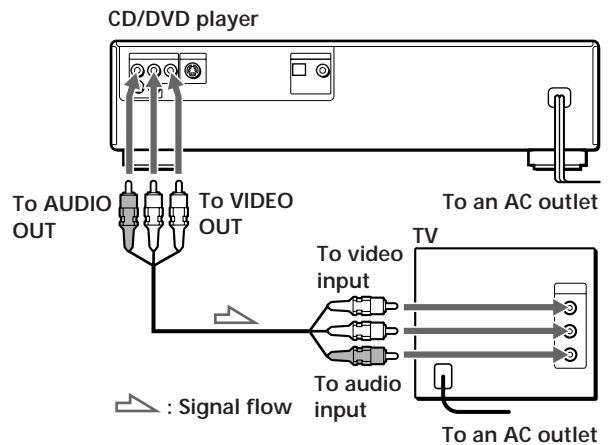

#### ■ To listen to the sound through speakers connected to an amplifier

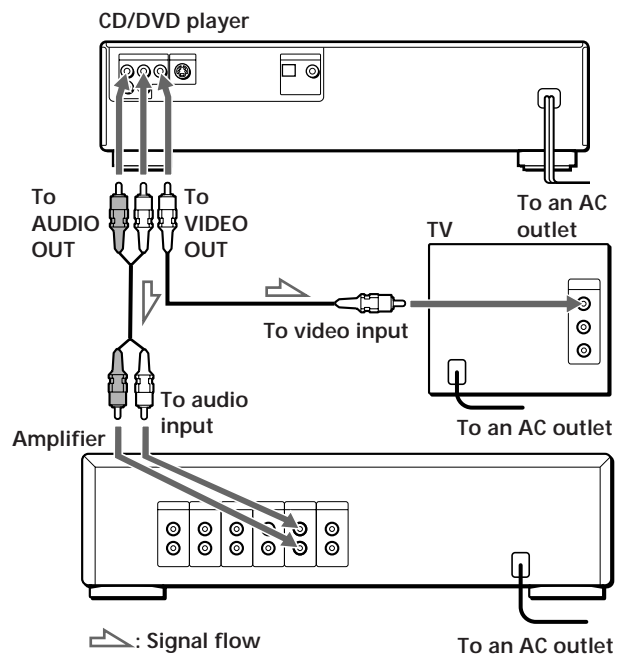

What cords will I need?

Audio/video connecting cord (supplied) (1)

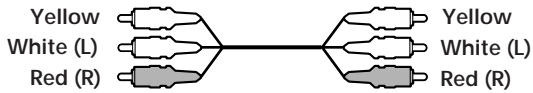

Hookups

When connecting the cord, be sure to match the color-coded cord to the appropriate jacks on the components: Yellow (video) to Yellow, Red (right) to Red and White (left) to White. Be sure to make connections firmly to avoid hum and noise.

- To listen to the sound through TV speakers  
Connect the TV using the audio/video connecting cord (supplied).

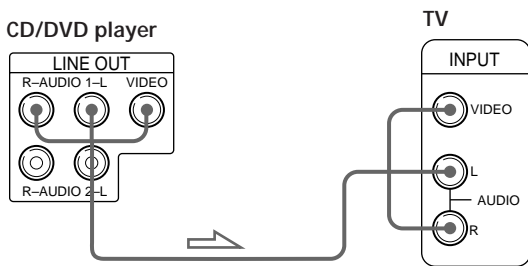

- To listen to the sound through speakers connected to an amplifier  
Connect the TV using a video connecting cord (not supplied), and the amplifier using an audio connecting cable (not supplied).

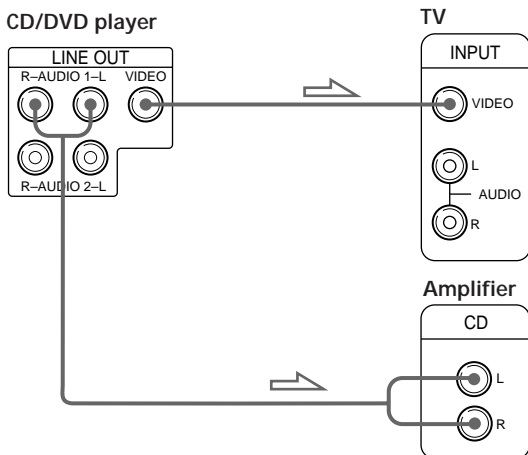

Make the same connections when your amplifier conforms to "Pro Logic."

Notes

- Do not connect this player to a video deck. If you view the pictures on your TV after making connections shown on the right, a picture noise may appear.
- Depending on the TV or amplifier, the sound distortion may occur because the audio output level is high. In this case, set "AUDIO ATT" in "CUSTOM SETUP" to "ON" in the menu. For details, see page 43.

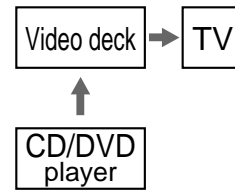

- 💡 If your TV has an S video input connector  
Connect the component via the S VIDEO OUT connector using the S video cable (supplied) instead of the video connecting cord. You will get a better picture.

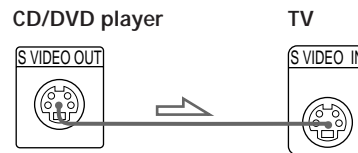
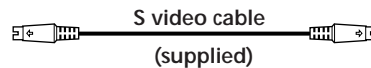

(Continued)

Manufactured under license from Dolby Laboratories Licensing Corporation. "Dolby", the double-D symbol , "Pro Logic" and "AC-3" are trademarks of Dolby Laboratories Licensing Corporation.



## Getting Started

**💡** If you have a digital component such as an amplifier with a digital input connector, DAT or MD  
Connect the component via the DIGITAL OUT OPTICAL or COAXIAL connector using an optical or coaxial cable (not supplied).

When you play a DVD, set "DVD DIGITAL OUT" in "INITIAL SETUP" to "PCM" in the menu. (page 44)

When you play a VIDEO CD, set "VIDEO CD DIGITAL OUT" in "INITIAL SETUP" to "ON" in the menu. (page 44)

When using an optical digital connecting cord

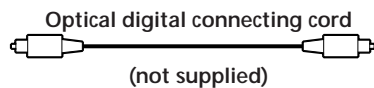

Take off the cap and plug in the optical cable.

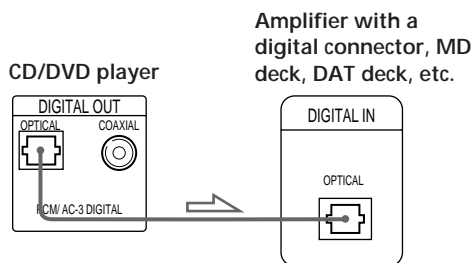

When using a coaxial digital connecting cord

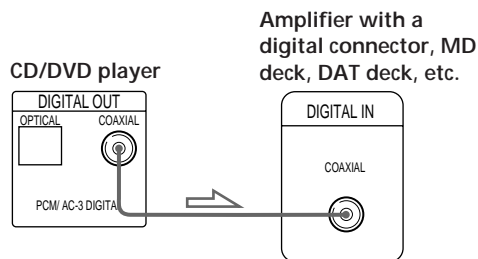
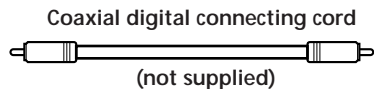

### Notes

- Refer to the instructions supplied with the component to be connected.
- You cannot make digital audio recordings of discs recorded in Dolby Digital (AC-3) format directly using MD deck or DAT deck.

When you make the connections above, do not set "DVD DIGITAL OUT" in "INITIAL SETUP" to "AC-3 Digital." If you do, a loud noise will suddenly come out from the speakers, affecting your ears or causing the speakers to be damaged.

**💡** If you have a digital component with a built-in Dolby Digital decoder

Connect the component via the DIGITAL OUT OPTICAL or COAXIAL connector using an optical or coaxial cable (not supplied). When the component with a built-in Dolby Digital decoder is connected, the player plays DVDs with sound recorded in Dolby Digital (AC-3) format while producing the effect of being in a movie theater or a concert hall.

In the menu, set "DVD DIGITAL OUT" in "INITIAL SETUP" to "AC-3 Digital." (page 44)

When using an optical digital connecting cord

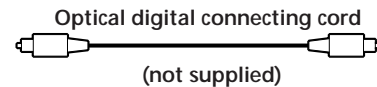

Take off the cap and plug in the optical cable.

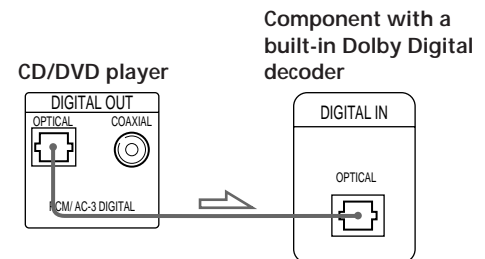

When using a coaxial digital connecting cord

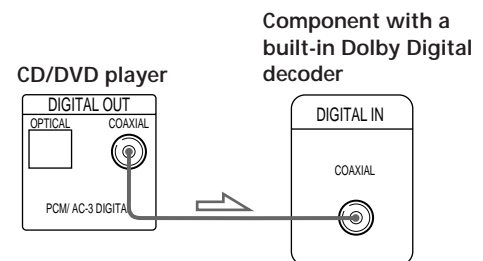
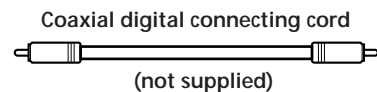

### Note

Refer to the instructions supplied with the component to be connected.

## Necessary Setup Before Using the Player

Some setups are necessary for the player depending on the TV or other components to be connected.

For details on using the menu, see page 40.

For details on each menu item, see pages 41 to 44.

- **To connect the player to a wide-screen TV**  
In the menu, set "TV TYPE" in "INITIAL SETUP" to "16:9."
- **To connect the player to a normal TV**  
In the menu, set "TV TYPE" in "INITIAL SETUP" to "4:3."
- **To listen to the stereo sound through speakers connected to a normal amplifier or through TV speakers**  
In the menu, set "DOWNMIX" in "INITIAL SETUP" to "NORMAL."
- **To listen to the sound through speakers connected to an amplifier that conforms to Dolby Pro Logic surround**  
In the menu, set "DOWNMIX" in "INITIAL SETUP" to "SURROUND."
- **To listen to the sound through speakers connected to an amplifier with a digital connector or to output the sound to a digital component such as a DAT or MD deck**  
When you play a DVD, set "DVD DIGITAL OUT" in "INITIAL SETUP" to "PCM" in the menu.  
When you play a VIDEO CD, set "VIDEO CD DIGITAL OUT" in "INITIAL SETUP" to "ON" in the menu.
- **To connect the player to a digital component with a built-in Dolby Digital decoder**  
In the menu, set "DVD DIGITAL OUT" in "INITIAL SETUP" to "AC-3 Digital."

"INITIAL SETUP" also includes other items such as "VIDEO ASPECT RATIO" and "OSD LANGUAGE."

For details, see page 43.

## To select the color system when you play a VIDEO CD

This player conforms to the NTSC and PAL color systems. In the menu, select the appropriate setting in "VIDEO CD COLOR SYSTEM" in "INITIAL SETUP" according to the TV to be connected to the player.

For details on using the menu, see page 40.

- **If the TV automatically changes the color system according to the input signal:**  
You do not need to select the setting of "VIDEO CD COLOR SYSTEM" as its default setting is "AUTO." The player automatically changes the color system of video output according to the color system of the VIDEO CD to be played.
- **If the color system of the TV is NTSC:**  
Set "VIDEO CD COLOR SYSTEM" to "NTSC." When you play a VIDEO CD recorded in the PAL color system, the picture will be stretched vertically and will be displayed with the upper and lower parts of the picture cut off.
- **If the color system of the TV is PAL:**  
Set "VIDEO CD COLOR SYSTEM" to "PAL." When you turn the power on, pictures may be displayed with no color or may not appear properly depending on the TV. If you cannot make menu setting on the TV screen because of the bad picture conditions, play a VIDEO CD recorded in the PAL color system before making setting. When "VIDEO CD COLOR SYSTEM" is set to "PAL," you cannot view the pictures of the DVD. When you play a VIDEO CD recorded in the NTSC color system, the picture will shrink a little vertically and will be displayed with the upper and lower parts of the screen masked in black.

The settings above are retained unless you disconnect the AC power cord or the electricity is cut off.

# Playing a DVD

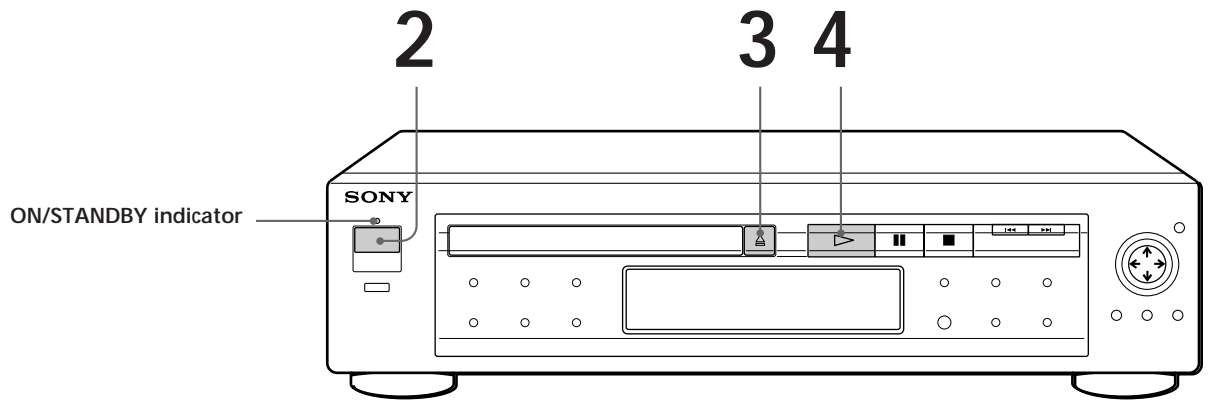

- The operating procedure of VIDEO CDs or CDs is different from that of DVDs.  
For details on playing a VIDEO CD, see pages 18 to 25.  
For details on playing a CD, see pages 26 to 31.

You can turn on the player using the remote  
Press POWER when the ON/STANDBY indicator on the front panel is lit in red.

After following Step 4  
A DVD menu or title menu may appear on the TV screen (see page 13 or 14).

**Note**  
If you don't operate the player or the remote for more than 30 minutes when a disc is not being played, the power is automatically turned off (Auto Power Off function).

Refer to the instructions supplied with your disc.

---

**1** **Make settings on your TV.**  
Turn on the TV and select the video input so that you can view the pictures from this player.

**When using an amplifier**  
Turn on the amplifier and select the appropriate position so that you can listen to the sound from this player.

---

**2** Press POWER to turn on the player.  
The ON/STANDBY indicator (red) changes to green and the front panel display lights up.

---

**3** Press and place the disc on the disc tray.

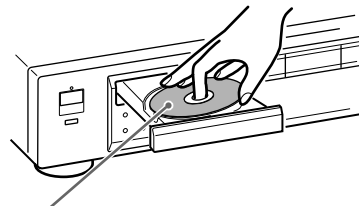

With the playback side facing down

---

**4** Press .

The disc tray closes, and the player starts playback (Continuous Play). Adjust the volume on the TV or the amplifier.

---

**💡** When "RESUME" appears on the front panel display  
 You can resume playback from the point where you stopped the DVD. For details on playing from the beginning of the disc, see page 36.

**Note**  
 You may not be able to do Resume Play depending on the DVD.

**To stop playback**

Press **■**.

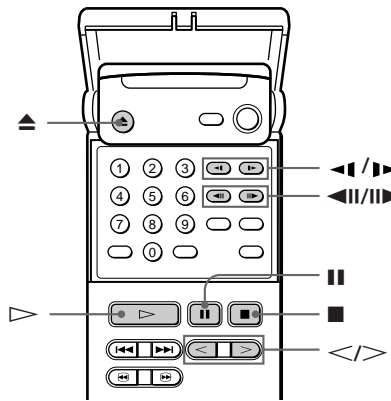
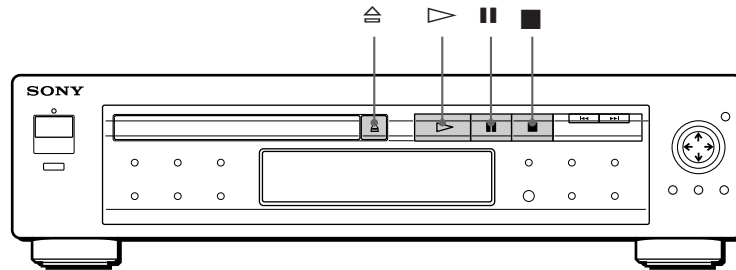

**💡** If you want to change the playback speed during Slow-motion play  
 Two speeds are available: SLOW 1 (about 1/15th the normal speed) and SLOW 2 (about 1/30th). Each time you press **◀** or **▶**, the indication changes as follows:  
 SLOW 1 **↔** SLOW 2

- Notes**
- Depending on the DVD, you may not do some of the operations described on the right.
  - When you play back a DVD at twice the normal speed in any direction, the sounds of the picture will come out from the LINE OUT (AUDIO 1, 2) connectors. The sounds are lower than the ones at normal speed. In this case, no sounds come out from the DIGITAL OUT OPTICAL and COAXIAL connectors.

**During playback**

To	Press
Pause	<b>⏸</b>
Resume play after pause	<b>⏸</b> or <b>▶</b>
Play frame by frame	<b>◀◀</b> or <b>▶▶</b>
Play in slow motion	<b>◀</b> or <b>▶</b>
Play at twice the normal speed	<b>&lt;</b> or <b>&gt;</b>
Stop play and remove the disc	<b>⏏</b>

**To return to Continuous Play mode**

Press **▷**.

**Locating a title, chapter or point you want**

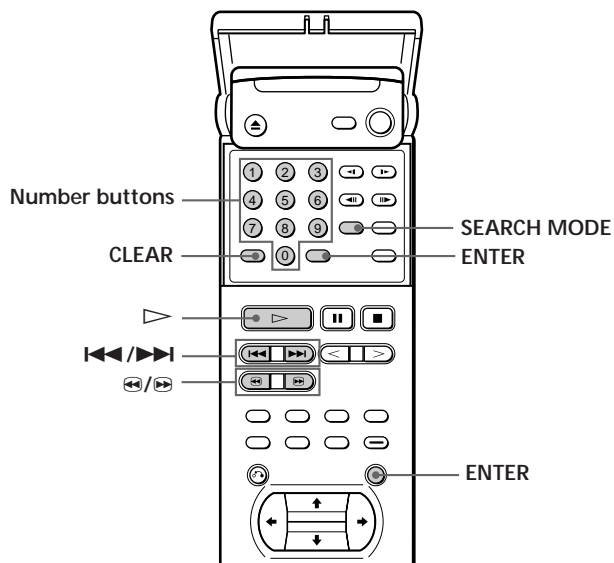
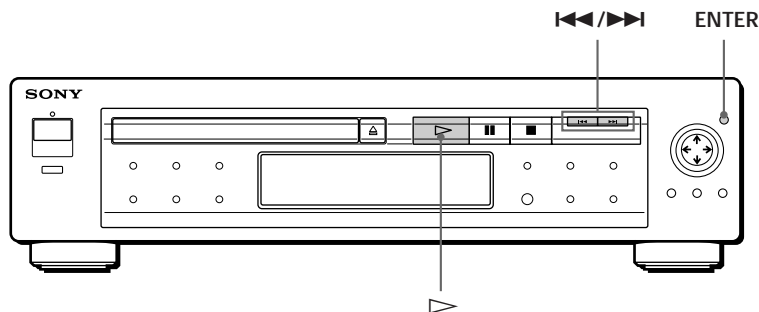

**☛** What are title and chapter?  
See page 5.

**☛** If you want to change the search speed  
Two speeds are available:  
FF1 or FR1 (about 10 times the normal speed) and FF2 or FR2 (about 30 times). Each time you press **↔** or **↔**, the indication changes as follows:  
FF1 (FR1) ↔ FF2 (FR2)

**☛** If you have made a mistake  
Press CLEAR, then the correct number button.

**☛** Each time you press SEARCH MODE  
"TITLE SEARCH,"  
"CHAPTER SEARCH" and  
"TIME SEARCH" appear on the TV screen.

**Note**  
Depending on the DVD, you may not do some of the operations described on the right.

To	Press
Go to the next chapter in Continuous Play mode	<b>▶▶</b>
Go back to the preceding chapter in Continuous Play mode	<b>◀◀</b>
Select the chapter	Number buttons to select the chapter number, then ENTER or <b>▷</b> .
Select the title	1 SEARCH MODE repeatedly until "TITLE SEARCH" appears on the TV screen. 2 Number buttons to select the title number, then ENTER or <b>▷</b> .
Locate a point using the time code	1 SEARCH MODE repeatedly until "TIME SEARCH" appears on the TV screen. 2 Number buttons to enter a time code, then ENTER or <b>▷</b> .
Locate a point while monitoring the picture (Search)	<b>↔/↔</b> . You will not hear the sound during this operation. When you find the point you want, press <b>▷</b> to return to the normal speed.

## Notes

- Depending on the DVD, you may not select the title.
- Depending on the DVD, a “title menu” may be simply called a “menu” or “title” in the instructions supplied with the disc. “Press ENTER.” in Step 3 may also be expressed as “Press SELECT.”

## Using the Title Menu

A DVD is divided into long sections of a picture or a music piece called “title.” When you play the DVD which contains several titles, you can select the title you want using the title menu.

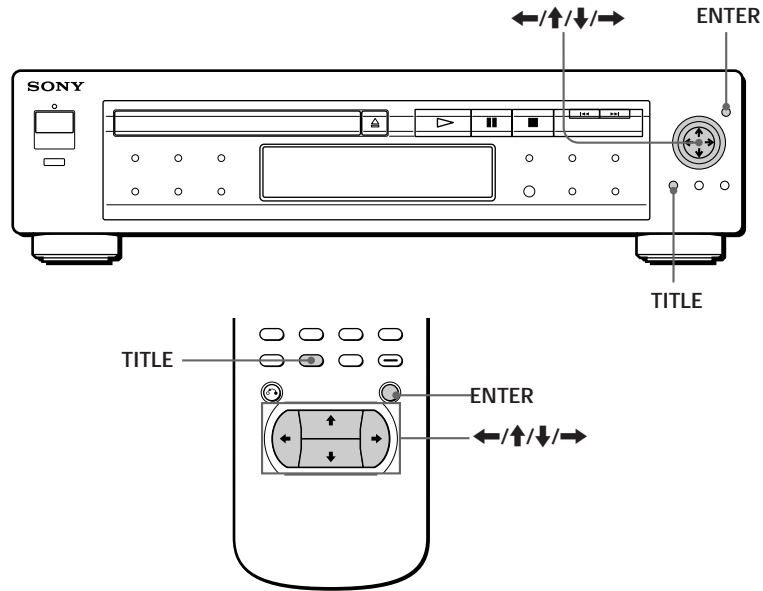

## 1 Press TITLE.

The title menu appears on the TV screen. The contents of the menu varies from disc to disc.

1	TITLE 1
2	TITLE 2
3	TITLE 3
4	TITLE 4

## 2 Press ←/↑/↓/→ to select the title you want to play.

Depending on the disc, you can use the number buttons to select the title.

## 3 Press ENTER.

The player starts playing the selected title.

 If you want to select the language for the DVD menu Change the setting using "INITIAL SETUP" in the normal menu (see page 44).

**Note**  
Depending on the DVD, a "DVD menu" may be simply called a "menu" in the instructions supplied with the disc. "Press ENTER." in Step 4 may also be expressed as "Press SELECT."

### Using the DVD menu

Some DVDs allows you to select the disc contents using the menu. When you play these DVDs, you can select the language for the subtitles, the language for the sound, etc., using the DVD menu.

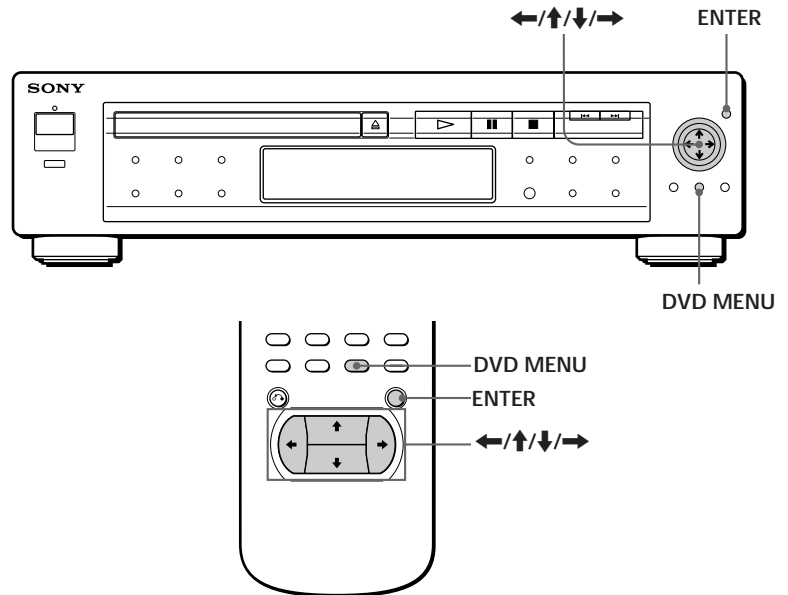

- 1** Press DVD MENU.  
The DVD menu appears on the TV screen. The contents of the menu vary from disc to disc.

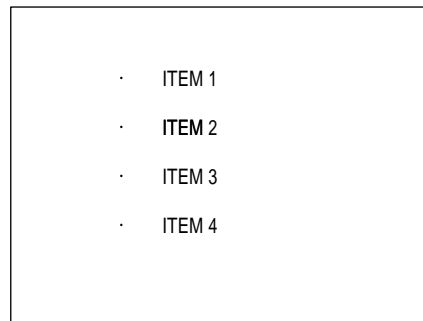

- 2** Press  $\leftarrow/\uparrow/\downarrow/\rightarrow$  to select the item you want to change.  
Depending on the disc, you can use the number buttons to select the item.

- 3** To change other items, repeat Step 2.

Press ENTER.

- 4**

### Using the On-Screen Display

You can check the operating status of the player and the information about the disc using the on-screen display on the TV screen.

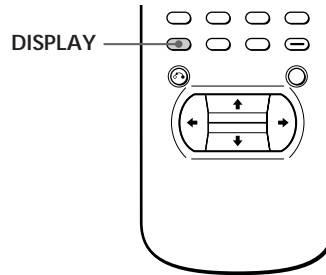

Press DISPLAY.

Each time you press the button, the on-screen display changes as follows:

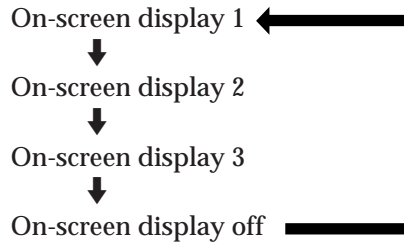

■ Display information of the on-screen display 1 mode

While playing a disc, the current title number, current chapter number and playing time are always displayed.

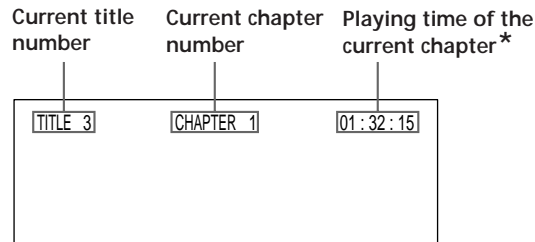

■ Display information of the on-screen display 2 mode

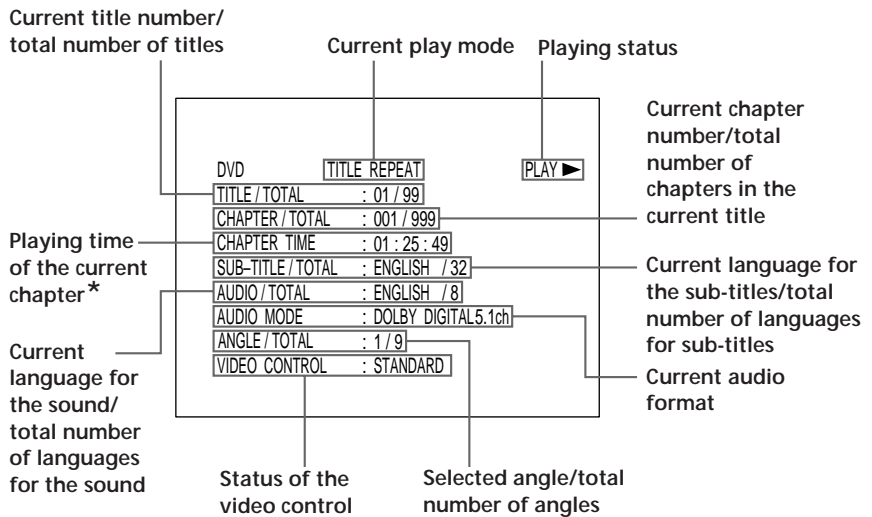

☞ What is play mode?  
See page 41.

☞ What is angle?  
See page 39.

☞ What are title and chapter?  
See page 5.

☞ What is language for the sound?  
See page 37.

☞ What is language for the sub-titles?  
See page 38.

Note  
Depending on the DVD, some information may not appear on the TV screen.

\* Each time you press TIME, the information changes as shown below.

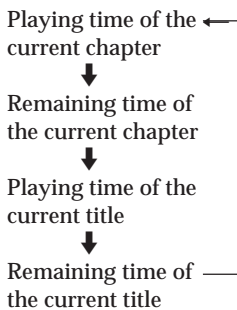





## What is bit rate?

Bit rate refers to the amount of video data per second in a disc. The higher the bit rate is, the larger the amount of data. However, this does not always mean that you can get higher quality pictures.

## Display information of the on-screen display 3 mode

While playing a disc, the approximate bit rate of the playback picture is always displayed.

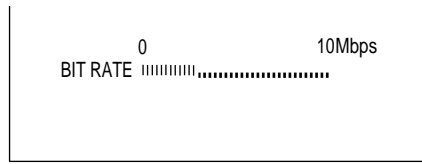

Bit rate of the playback picture

## Display information of the on-screen display off mode

No information is displayed. (Messages, etc., will be displayed.)

## Using the Front Panel Display

You can check the information about the disc, such as the total number of the titles or remaining time, using the front panel display.

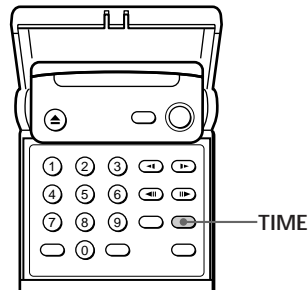

## Display information while playing the disc

Lights up while playing the sections with the auto pause signal

Current sound status

Playing status

Lights up when you can switch the angles

Lights up when you can do Resume Play



Current title number

Current chapter number

Disc type

Playing time

Current play mode

■ Checking the remaining time

Each time you press TIME while playing the disc, the display changes as shown in the chart below. The time information in the on-screen display 1 or 2 mode also changes each time you press TIME.

Note  
Depending on the DVD, the chapter number or time may not appear.

Playing time and number of the current chapter



Remaining time of the current chapter

Press TIME



Playing time and number of the current title

Press TIME



Remaining time of the current title

Press TIME



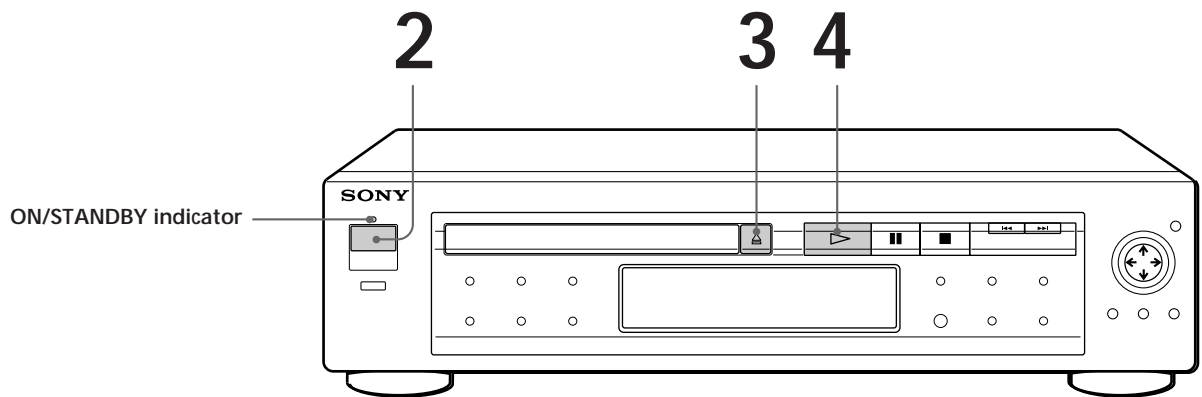

Press TIME

# Playing a VIDEO CD



- The operating procedure of DVDs or CDs is different from that of VIDEO CDs.  
For details on playing a DVD, see pages 10 to 17.  
For details on playing a CD, see pages 26 to 31.

 You can turn on the player using the remote  
Press POWER when the ON/STANDBY indicator on the front panel is lit in red.

 After following Step 4  
The menu screen may appear on the TV screen depending on the VIDEO CD. You can play the disc interactively, following the instructions on the menu screen. (PBC Playback, see page 21.)

**Note**  
If you don't operate the player or the remote for more than 30 minutes when a disc is not being played, the power is automatically turned off (Auto Power Off function).

Refer to the instructions supplied with your disc.

---

**1** **Make settings on your TV.**  
Turn on the TV and select the video input so that you can view the pictures from this player.

**When using an amplifier**

Turn on the amplifier and select the appropriate position so that you can listen to the sound from this player.

---

**2** Press POWER to turn on the player.  
The ON/STANDBY indicator (red) changes to green and the front panel display lights up.

---

**3** Press , and place the disc on the disc tray.

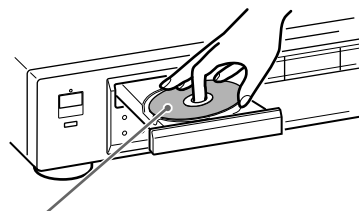

With the label side facing up

---

**4** Press .  
The disc tray closes and the player starts playback (Continuous Play). Adjust the volume on the TV or the amplifier.

---





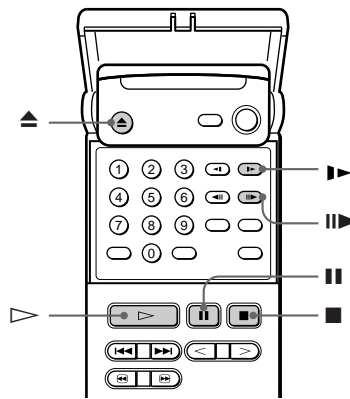
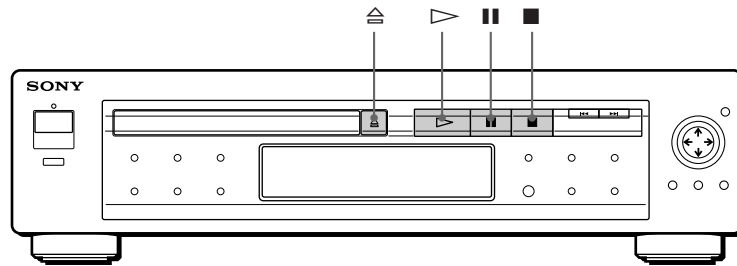

 When "RESUME" appears on the front panel display  
You can resume playback from the point where you stopped the VIDEO CD. For details on playing from the beginning of the disc, see page 36.

### To stop playback

Press .





### During playback

To	Press
Pause	
Resume play after pause	 or 
Play frame by frame	
Play in slow motion	
Stop play and remove the disc	

### To return to Continuous Play mode

Press .

 If you want to change the playback speed during Slow-motion play  
Two speeds are available: SLOW 1 and SLOW 2. Each time you press , the indication changes as follows:  
SLOW 1  SLOW 2

Locating a track or point you want

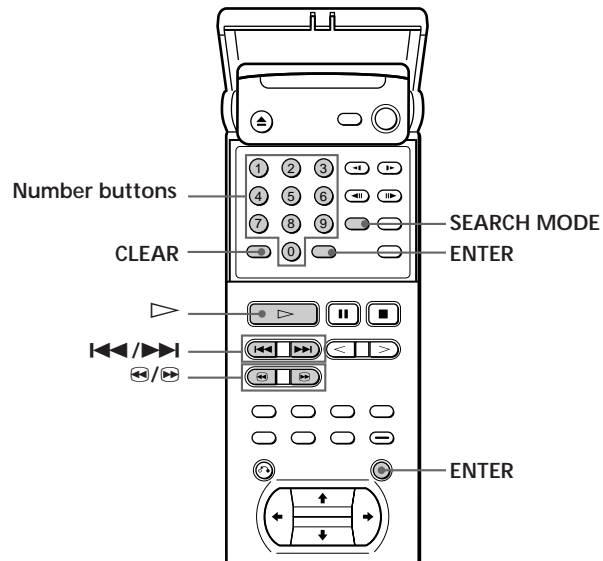
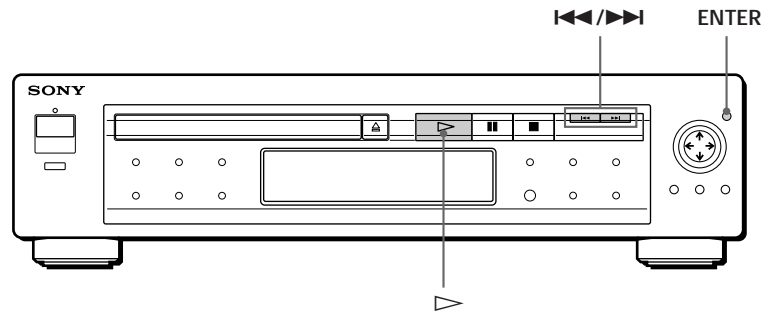

What is a track?  
See page 5.

What is an index?  
See page 5.

What is a scene?  
See page 5.

If you want to change the search speed  
Two speeds are available: FF1 or FR1 and FF2 or FR2. Each time you press or , the indication changes as follows:  
FF1 (FR1)  $\leftrightarrow$  FF2 (FR2)

If you have made a mistake  
Press CLEAR, then the correct number button.





Each time you press SEARCH MODE "TRACK SEARCH," "SCENE SEARCH" and "VIDEO INDEX SEARCH" appear on the TV screen.

**Note**  
Some discs do not allow you to start playing from a particular scene. In this case, if you do Scene Search before you start playing, the player starts playing from scene 1. If you do Scene Search while playing a disc, the player starts playing from the current scene.

To	Press
Go to the next track in Continuous Play mode	
Go back to the preceding track in Continuous Play mode	
Select the track	Number buttons to select the track number, then ENTER or .
Select the index in Continuous Play mode	1 SEARCH MODE repeatedly until "VIDEO INDEX SEARCH" appears on the TV screen. 2 Number buttons to select the index number, then ENTER or .
Select the scene before you start playing a VIDEO CD with PBC functions and during PBC playback (Scene Search)	1 SEARCH MODE repeatedly until "SCENE SEARCH" appears on the TV screen. 2 Number buttons to select the scene number, then ENTER or . (To check the current scene number, press DISPLAY. The scene number appears at the left top of the TV screen.)
Locate a point while monitoring the picture (Search)	. You will not hear the sound during this operation. When you find the point you want, press  to return to the normal speed.

 When playing VIDEO CDs with PBC functions PBC playback starts automatically.

 To cancel PBC playback of a VIDEO CD with PBC functions and play the disc in Continuous Play mode There are two ways.





- Before you start playing, select the track you want using  or , then press ENTER or .
- Before you start playing, select the track number using the number buttons on the remote, then press ENTER or .

“PLAY WITHOUT PBC” appears on the TV screen and the player starts Continuous Play. You cannot play still pictures such as a menu screen.

### Playing VIDEO CDs with PBC Functions (PBC Playback)



When playing VIDEO CDs with PBC functions (Ver. 2.0 discs), you can enjoy simple interactive operations, operations with search functions, etc.

PBC Playback allows you to play VIDEO CDs interactively, following the menu screen on the TV screen.

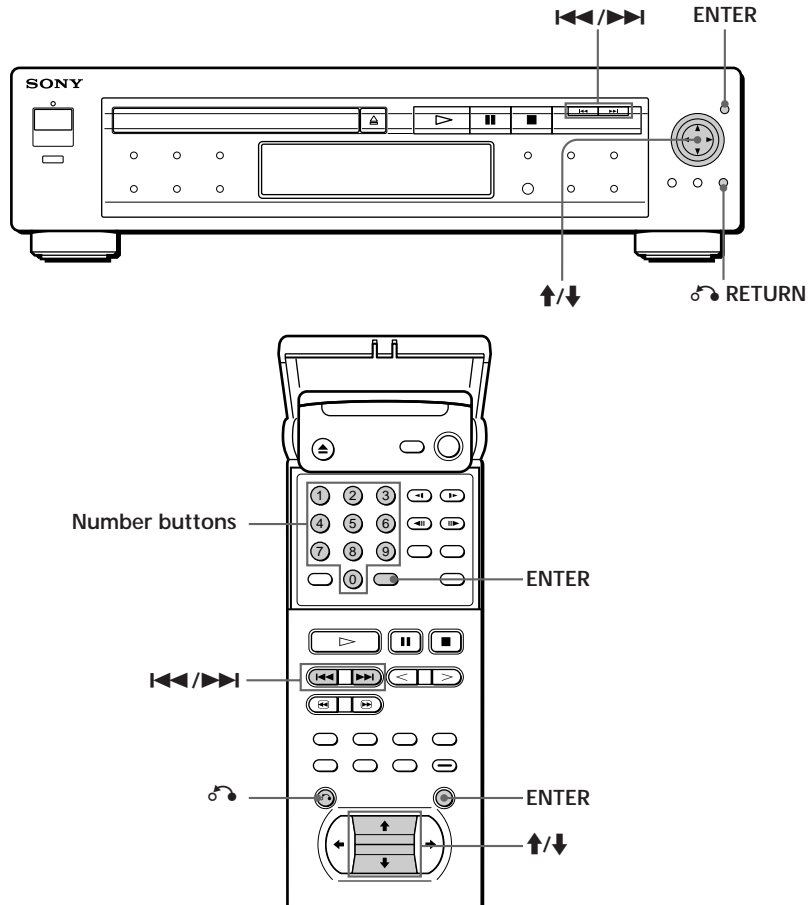
On this player, you can use the number buttons, ENTER, , , / and  (RETURN) during PBC Playback.



**1** Start playing a VIDEO CD with PBC functions, following Steps 1 to 4 in “Playing a VIDEO CD” on page 18.

**2** Select the item number you want.  
On the player  
Press / to select the item number.

On the remote  
Press the number button of the item you want.

(Continued)

**Note**

Depending on the VIDEO CD, "Press ENTER." in Step 3 may be expressed as "Press SELECT." in the instructions supplied with the disc.

**3** Press ENTER.

**4** Follow the instructions on the menu screen for interactive operations.

Refer to the instructions supplied with the disc, as the operating procedure may differ according to the VIDEO CD.

When	Do the following
Selecting the item	On the player, press ▲/▼ to select the item number, then press ENTER.
	On the remote, press the number button of the item you want, then press ENTER.
Going back to the menu screen	Press ⏪ (RETURN), ⏮, or ⏭.

### Using the On-Screen Display

You can check the operating status of the player and the information about the disc using the on-screen display on the TV screen.

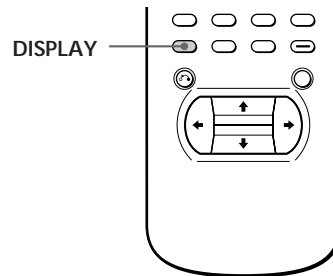

Press DISPLAY.

Each time you press the button, the on-screen display changes as follows:

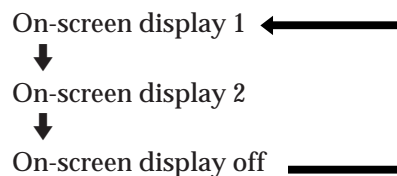

■ Display information of the on-screen display 1 mode

- During PBC playback

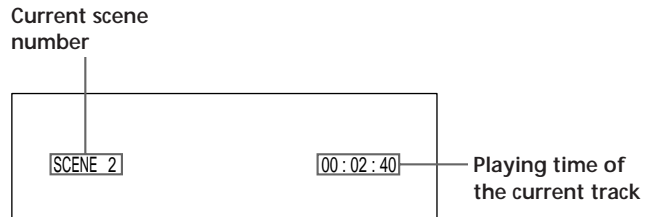

- In Continuous Play mode

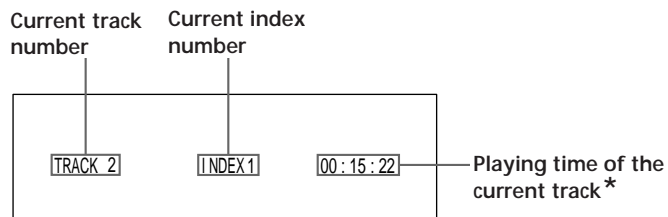

■ Display information of the on-screen display 2 mode

- During PBC playback

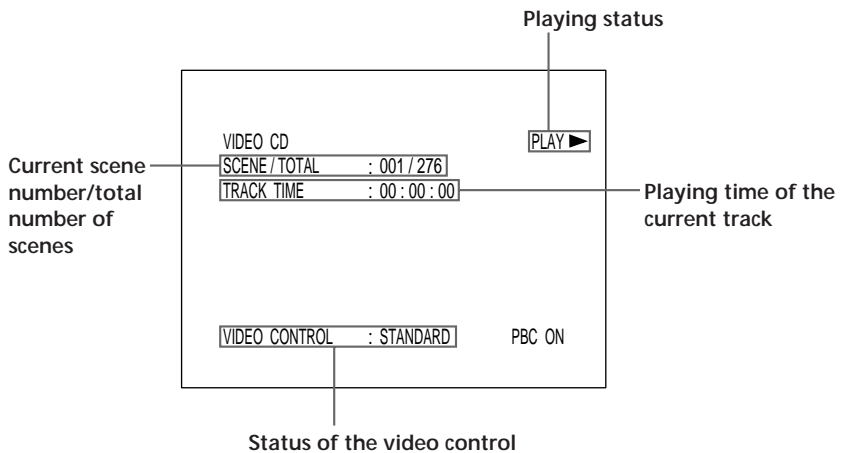

💡 What is a track?  
See page 5.

💡 What is a scene?  
See page 5.

\* Each time you press TIME, the information changes as shown below.

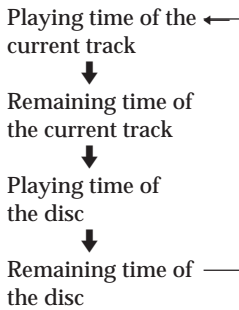

While you are doing Shuffle Play or Program Play, the playing time of the disc and the remaining time of the disc are not displayed.



**💡** What is play mode?  
See page 41.

\* Each time you press TIME, the information changes as shown below.

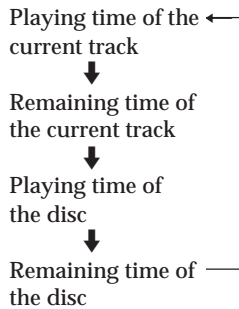

While you are doing Shuffle Play or Program Play, the playing time of the disc and the remaining time of the disc are not displayed.

• In Continuous Play mode

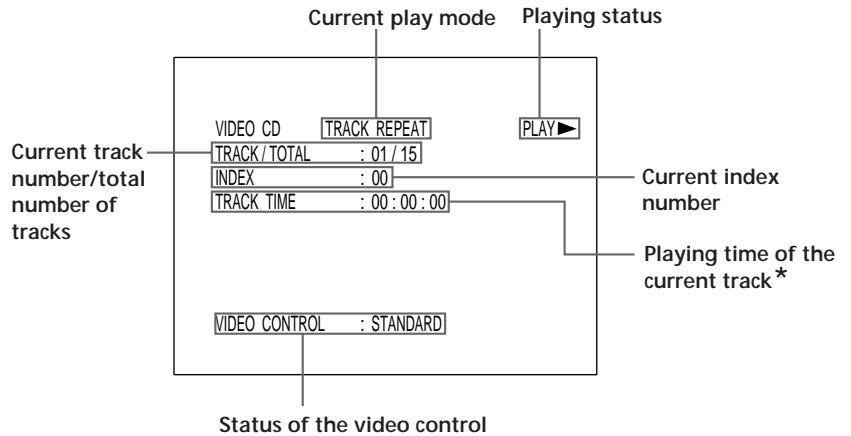

■ Display information of the on-screen display off mode  
No information is displayed. (Messages, etc., will be displayed.)

## Using the Front Panel Display

You can check the information about the disc, such as the total number of the tracks or remaining time, using the front panel display.

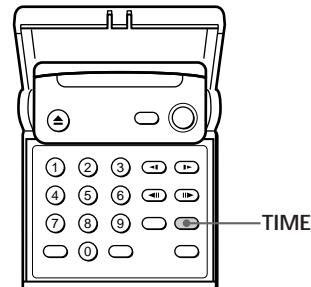

■ Display information while playing a disc

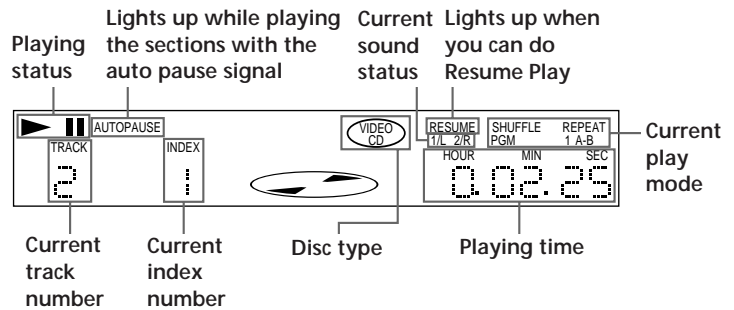

**💡** During PBC playback Current scene number appears instead of track and index numbers. The display does not change even if you press the TIME button at this time.

**Note**  
While you are doing Shuffle Play or Program Play, the playing time of the disc and the remaining time of the disc are not displayed.

■ Checking the remaining time (in Continuous Play mode only)

Each time you press TIME while playing a disc, the display changes as shown in the chart below. The time information in the on-screen display 1 or 2 mode also changes each time you press TIME.

Playing time and number of the current track



Remaining time of the current track



Playing time of the disc



Remaining time of the disc



Press TIME

# Playing a CD

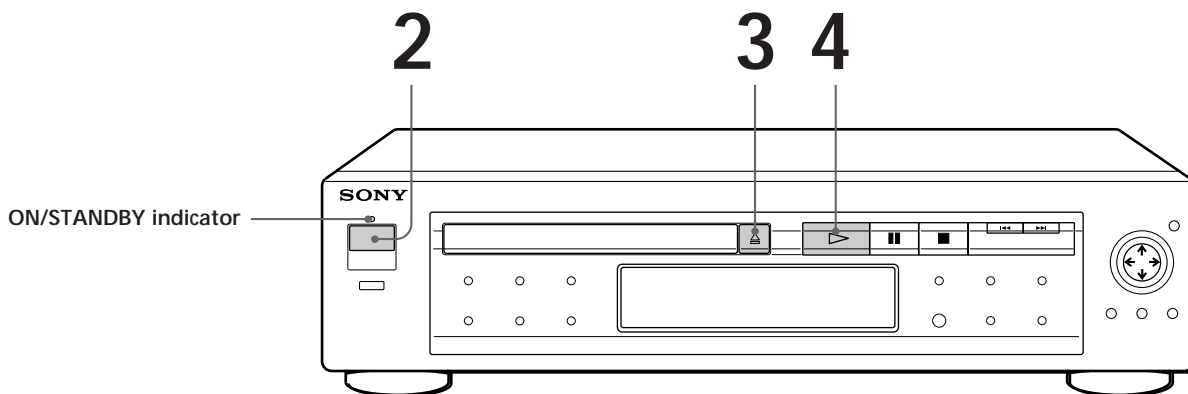

- The operating procedure of DVDs or VIDEO CDs is different from that of CDs.  
For details on playing a DVD, see pages 10 to 17.  
For details on playing a VIDEO CD, see pages 18 to 25.

 You can turn on the player using the remote  
Press POWER when the ON/STANDBY indicator on the front panel is lit in red.

---

**1** Make settings on your TV.  
Turn on the TV and select the video input so that you can view the pictures from this player.

**When using an amplifier**

Turn on the amplifier and select the appropriate position so that you can listen to the sound from this player.

---

**2** Press POWER to turn on the player.  
The ON/STANDBY indicator (red) changes to green and the front panel display lights up.

---

**3** Press , and place the disc on the disc tray.

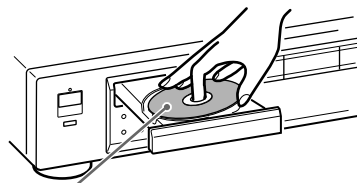

With the label side facing up

---

**4** Press .  
The disc tray closes and the player starts playback (Continuous Play). Adjust the volume on the TV or the amplifier.

---

**Note**  
If you don't operate the player or the remote for more than 30 minutes when a disc is not being played, the power is automatically turned off (Auto Power Off function).



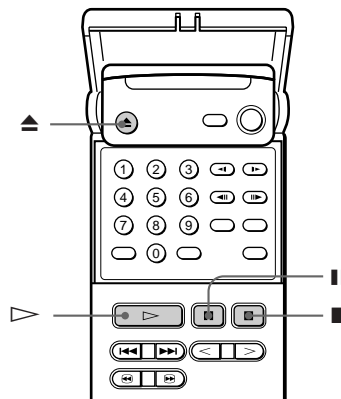
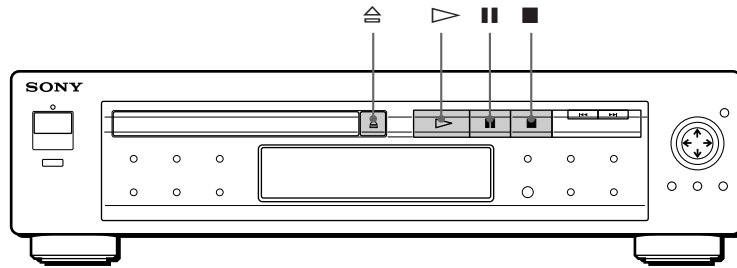

 When "RESUME" appears in the front panel display  
 You can resume playback from the point where you stopped the CD. For details on playing from the beginning of the disc, see page 36.

### To stop playback

Press .









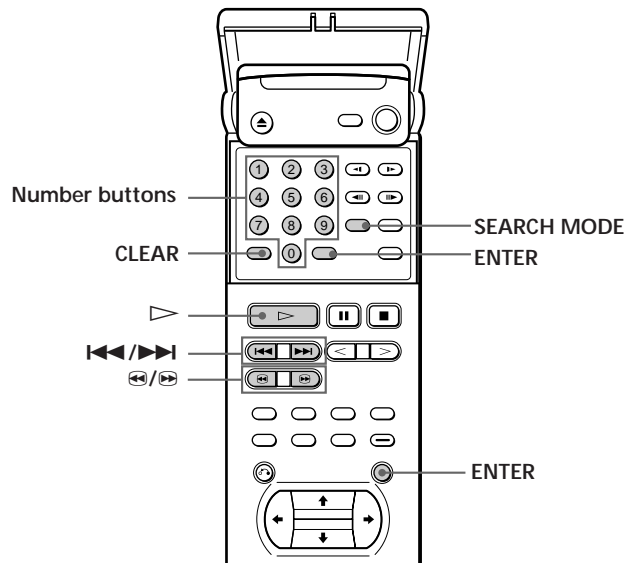
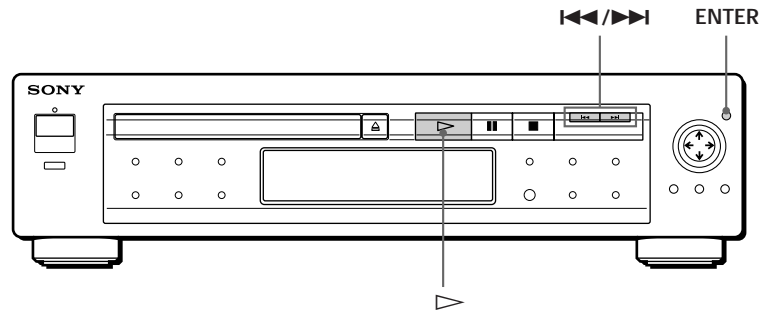





### During playback

To	Press
Pause	
Resume play after pause	 or 
Stop play and remove the disc	

**Locating a track or point you want**



-  **What is a track?**  
See page 5.
-  **What is an index?**  
See page 5.
-  **If you want to change the search speed**  
Two speeds are available:  
FF1 or FR1 and FF2 or FR2.  
Each time you press  or ,  
the indication changes as follows:  
FF1 (FR1)  FF2 (FR2)
-  **If you have made a mistake**  
Press CLEAR, then the correct number button.

To	Press
Go to the next track in Continuous Play mode	
Go back to the preceding track in Continuous Play mode	
Select the track	Number buttons to select the track number, then ENTER or  .
Select the index in Continuous Play mode	1 SEARCH MODE repeatedly until "INDEX SEARCH" appears on the TV screen. 2 Number buttons to select the index number, then ENTER or  .
Locate a point while monitoring the sound (Search)	 . When you find the point you want, press  to return to the normal speed.

### Using the On-Screen Display

You can check the operating status of the player and the information about the disc using the on-screen display on the TV screen.

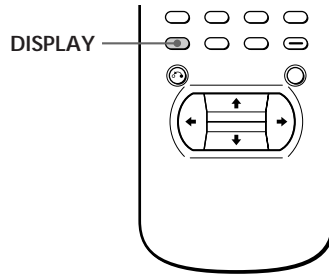

Press DISPLAY.

Each time you press the button, the on-screen display changes as follows:

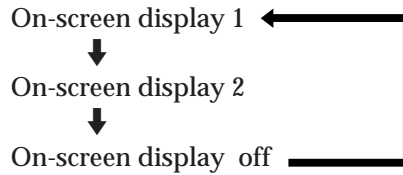

#### ■ Display information of the on-screen display 1 mode

While playing a disc, the current track number, playing time and index number are always displayed.

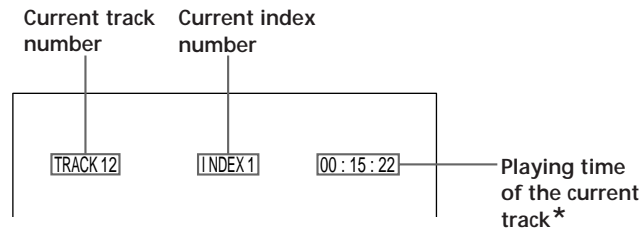

\* Each time you press TIME, the information changes as shown below.

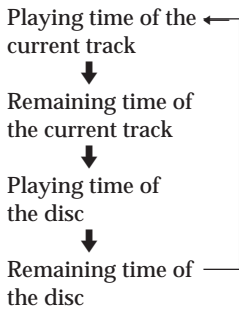

While you are doing Shuffle Play or Program Play, the playing time of the disc and the remaining time of the disc are not displayed.

#### ■ Display information of the on-screen display 2 mode

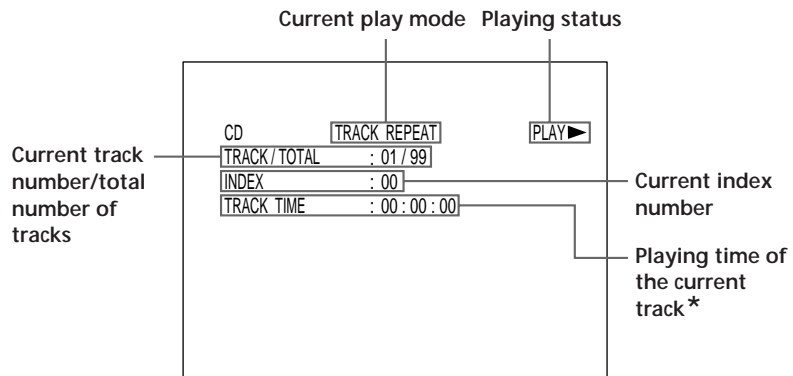

#### ■ Display information of the on-screen display off mode

No information is displayed. (Messages, etc., will be displayed.)

### Using the Front Panel Display

You can check information about the disc, such as the total number of the tracks, remaining number of tracks or remaining time, using the front panel display.

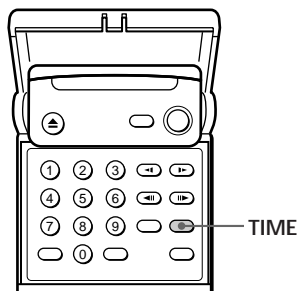

■ Display information while playing a disc

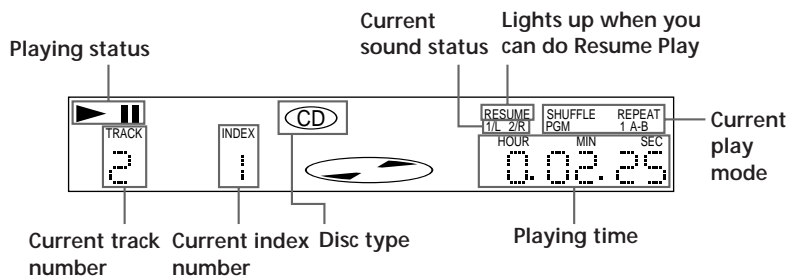

**Note**  
While you are doing Shuffle Play or Program Play, the playing time of the disc and the remaining time of the disc are not displayed.

■ Checking the remaining time

Each time you press TIME while playing a disc, the display changes as shown in the chart below. The time information in the on-screen display 1 or 2 mode also changes each time you press TIME.

Playing time and number of the current track



Remaining time of the current track



Playing time of the disc



Remaining time of the disc

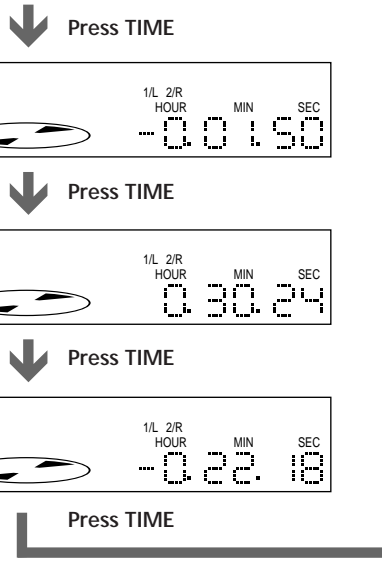



## Playing Repeatedly (Repeat Play)

You can play the all the titles/all the tracks on a disc, a single title/chapter/track or a specific portion repeatedly. To set the Repeat Play, use the menu. For details on using the menu, see page 40.

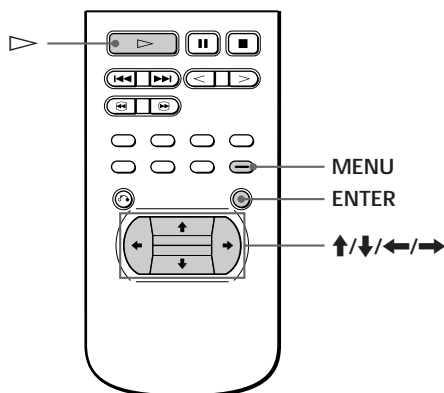

### Repeating all the titles or all the tracks on a disc

In Shuffle or Program Play mode, the player repeats the titles or tracks in the shuffled or programmed order.

You cannot do Repeat Play during PBC playback of VIDEO CDs (page 21). You may not be able to do Repeat Play depending on the DVD.

Press MENU to display the menu on the TV screen. Then set "REPEAT" in "PLAY MODE" to "DISC."

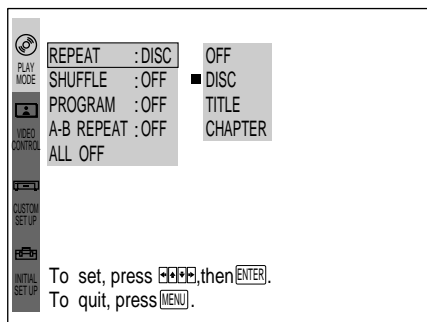

"REPEAT" appears on the front panel display. The player repeats the titles/chapters/tracks as follows:

When the disc is played in	The player repeats
Continuous Play (page 10, 18 or 26)	All the titles /all the tracks
Shuffle Play (page 34)	All the titles or tracks in random order
Program Play (page 34)	Programmed titles/chapters/tracks

To cancel repeating all the titles or all the tracks on a disc Press MENU to display the menu on the TV screen. Then set "REPEAT" in "PLAY MODE" to "OFF" (page 41).

### Repeating the current title or chapter



You can repeat only the current title or chapter in Continuous Play mode. You may not be able to do Repeat Play depending on the DVD.

#### ■ Repeating the current title

While the title you want is being played, press MENU to display the menu on the TV screen. Then set "REPEAT" in "PLAY MODE" to "TITLE."

"REPEAT 1" appears on the front panel display and the player repeats the current title.

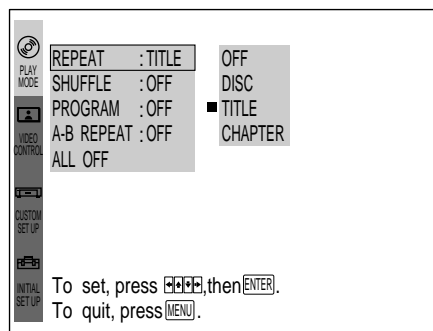

#### ■ Repeating the current chapter

While the chapter you want is being played, press MENU to display the menu on the TV screen. Then set "REPEAT" in "PLAY MODE" to "CHAPTER."

"REPEAT 1" appears on the front panel display and the player repeats the current chapter.

#### To cancel repeating the current title or chapter

Press MENU to display the menu on the TV screen. Then set "REPEAT" in "PLAY MODE" to "OFF" (page 41).

## Repeating the current track

You can repeat only the current track in Continuous Play mode.

While the track you want is being played, press MENU to display the menu on the TV screen. Then set "REPEAT" in "PLAY MODE" to "TRACK."

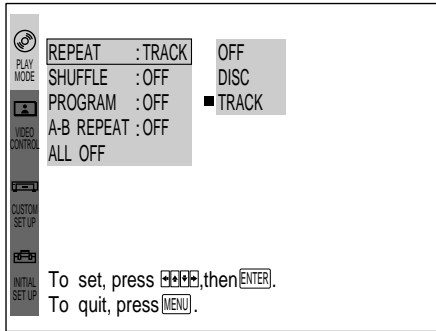

"REPEAT 1" appears on the front panel display and the player repeats the current track.

To cancel repeating the current track

Press MENU to display the menu on the TV screen. Then set "REPEAT" in "PLAY MODE" to "OFF" (page 41).

## Repeating a specific portion

### (A↔B Repeat)

You can play a specific portion of a title/chapter/track repeatedly. This is useful when you want to memorize lyrics.

During PBC Playback of VIDEO CDs (page 21), this function is available only while playing moving pictures.

You may not be able to do Repeat Play depending on the DVD.

- 1 While playing a disc, press MENU to display the menu on the TV screen. Then select "A-B REPEAT" in "PLAY MODE." "A-B REPEAT" is highlighted.

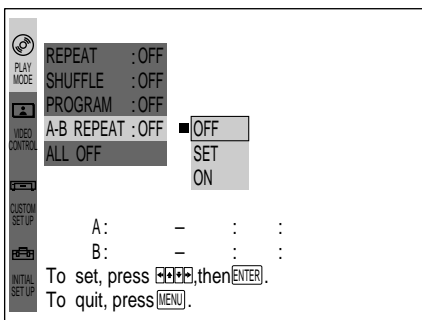

- 2 Select "SET" using ↑/↓ and press ENTER. The on-screen display for setting the point A appears indicating the current chapter or track number and playing time.

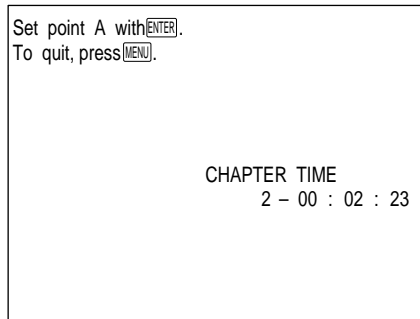

- 3 When you find the starting point (point A) of the portion to be played repeatedly, press ENTER. The display for setting the point B appears. "REPEAT A -" also appears on the front panel display.

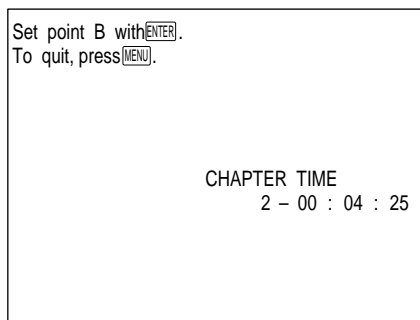

- 4 When you reach the ending point (point B), press ENTER. "REPEAT A-B" appears on the front panel display. The player starts repeating this specific portion.

To cancel A↔B Repeat

Press MENU to display the menu on the TV screen. Then set "A-B REPEAT" in "PLAY MODE" to "OFF" (page 41).

To cancel setting halfway

Press MENU.



The setting for A↔B Repeat remains after it is canceled

When you select "ON" using ↑/↓ in Step 2 and press ENTER, you can play the same portion again.

### Notes

- When you open the disc tray, the setting for A↔B Repeat is canceled.
- When you turn the power off, the setting for A↔B Repeat is canceled.
- When you set the A↔B Repeat, the settings for Shuffle Play and Program Play are canceled.
- Some scenes in the DVD and VIDEO CD do not allow you to do A↔B Repeat playback.

## Playing in Random Order (Shuffle Play)



You can have the player “shuffle” titles, chapters or tracks and play them in a random order. To set the Shuffle Play, use the menu. For details on using the menu, see page 40.

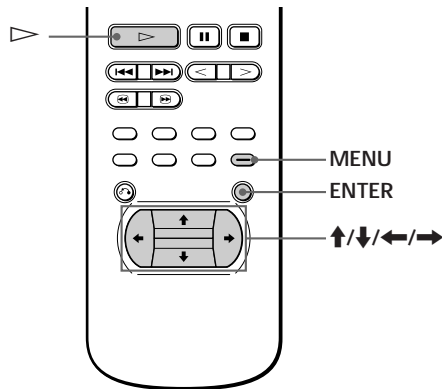

- 1 Press MENU to display the menu on the TV screen. Then set “SHUFFLE” in “PLAY MODE” to “ON.”

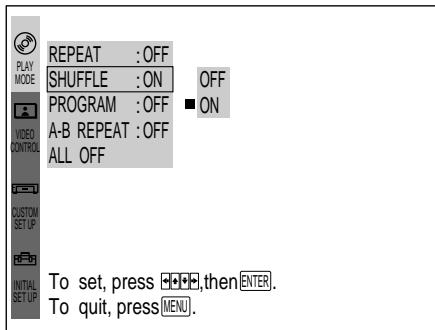

- 2 Press ▷.  
 (During playback, the player starts Shuffle Play when you follow the step 1.)

### To cancel Shuffle Play

Press MENU to display the menu on the TV screen. Then set “SHUFFLE” in “PLAY MODE” to “OFF.”

### Notes

- When you disconnect the AC power cord from the AC outlet, Shuffle Play is canceled.
- You may not be able to do Shuffle Play depending on the DVD.

## Creating Your Own Program (Program Play)



You can arrange the order of the titles, chapters or tracks on the disc and create your own program. The program can contain up to 99 titles, chapters and tracks.

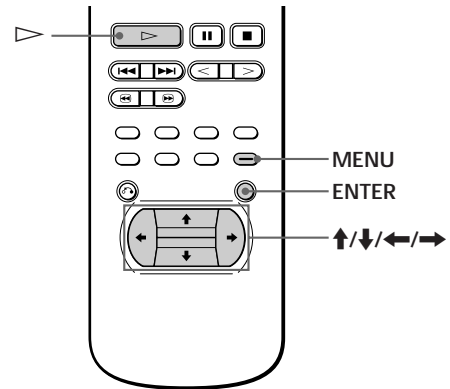

- 1 Press MENU to display the menu on the TV screen.

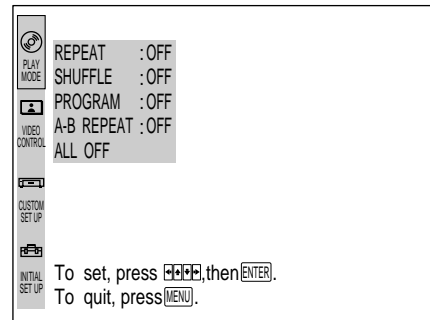

- 2 Select “PLAY MODE” using ↑/↓, then press →. “PLAY MODE” is highlighted.

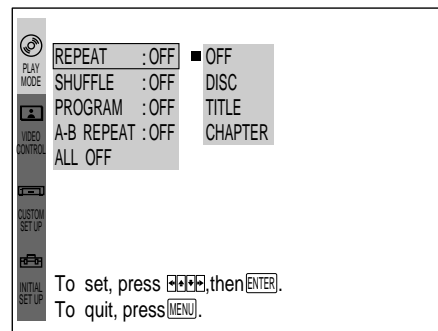

- 3 Select "PROGRAM" using  $\uparrow/\downarrow$ , then press  $\rightarrow$ .  
"PROGRAM" is highlighted.

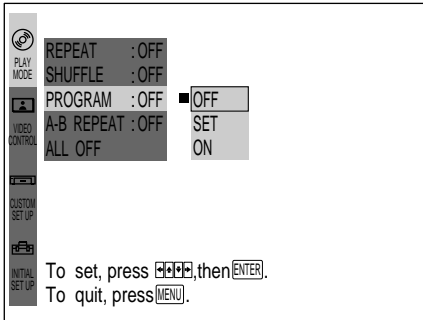

- 4 Select "SET" using  $\uparrow/\downarrow$ , then press ENTER.  
The programming display appears.

"TRACK" is displayed when you play a VIDEO CD or a CD.

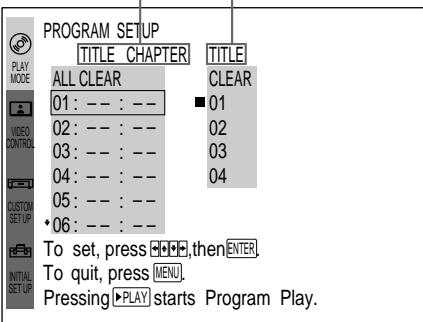

- 5 Press  $\rightarrow$ .  
"01" is highlighted.

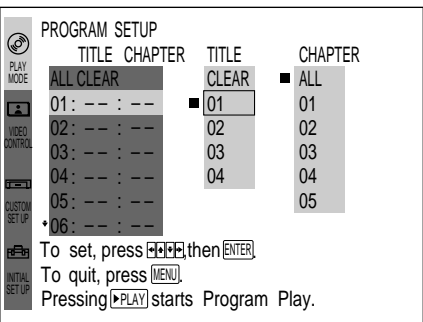

- 6 Select the title, chapter or track you want to program using  $\uparrow/\downarrow$ , then press ENTER.  
(You can also use the number buttons and ENTER button to select. The selected number appears at the top right of the screen.)

- When playing a DVD  
When both titles and chapters are recorded on the disc, select the title, then the chapter.

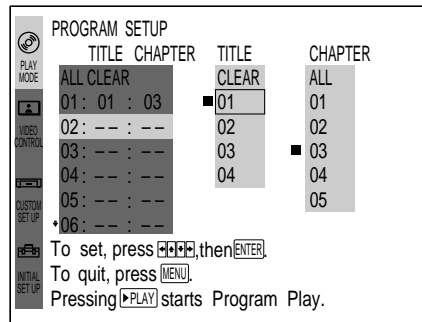
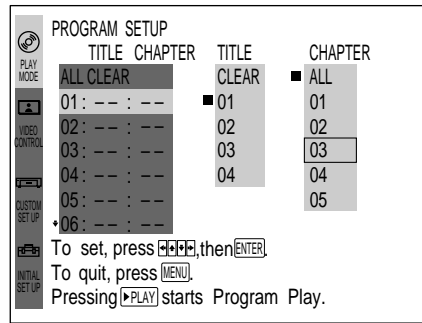

- When playing a VIDEO CD or CD  
Select the track you want to program.

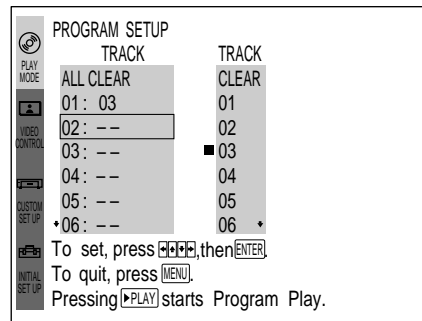

- 7 To program other titles, chapters or tracks, repeat Step 6.

The programmed titles, chapters or tracks are displayed from 02 in order.

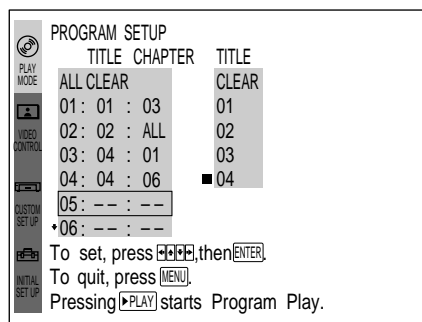

(Continued)

- 8 Press  $\triangleright$  to start Program Play.

### To cancel Program Play

Press MENU to display the menu on the TV screen. Then set "PROGRAM" in "PLAY MODE" to "OFF."

### To cancel programming

Press MENU.

### To change programming

- 1 In Step 5, select the program number of the title, chapter or track you want to change using  $\uparrow/\downarrow$ .
- 2 Follow Step 6 for new programming.

### To cancel the programmed order

To cancel all the titles, chapters or tracks in the programmed order, select "ALL CLEAR" in Step 5.

To cancel a title, chapter or track programmed, select the title, chapter or track you want to clear in Step 5, then select "CLEAR" in Step 6.



### The program remains even after the Program Play ends

When you press  $\triangleright$ , you can play the same program again.



### You can do Repeat Play or Shuffle Play of the programmed titles, chapters or tracks

After programming, set "REPEAT" to "DISC" or "SHUFFLE" to "ON" in the menu.

### Notes

- The number of titles, chapters or tracks displayed are that of the titles, chapters or tracks recorded on a disc.
- The program is canceled when:
  - you open or close the disc tray
  - you turn the power off
- You may not be able to do Program Play depending on the DVD.

## Resuming Playback from the Point Where You Stopped a Disc (Resume Play)



The player stores the point where you stopped a disc if "RESUME" appears on the front panel display. In this case, you can resume playback from that point.

As long as you do not remove the disc, Resume Play is available even if you turn the power off.

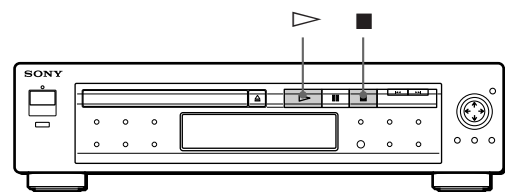

- 1 While playing a disc, press  $\blacksquare$  to stop playback. "RESUME" appears in the front panel display and "WHEN PLAYING NEXT TIME, DISC RESTARTS FROM POINT YOU STOPPED." appears on the TV screen. If "RESUME" does not appear, Resume Play is not available.

- 2 Press  $\triangleright$ . The player starts playback from the point you stopped the disc in Step 1.



### To play from the beginning of the disc

When "RESUME" appears on the front panel display before you start playing, press  $\blacksquare$  to turn off "RESUME," then press  $\triangleright$ .

### Notes

- You may not do Resume Play depending on the DVD.
- Resume Play is not available in Shuffle or Program Play mode.
- Depending on where you stopped the disc, the player may resume playback from a different point.
- The point where you stopped playing is cleared when:
  - you open or close the disc tray
  - you disconnect the AC power cord
  - you change the play mode
  - you start playback after selecting a title, chapter or track
  - you change the setting of "VIDEO ASPECT RATIO" or "DVD MENU LANGUAGE" in "INITIAL SETUP" in the menu

## Reducing the Picture Noise (DNR: Digital Video Noise Reduction)



You can make the picture clearer by reducing the picture noise.

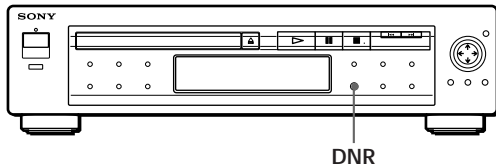
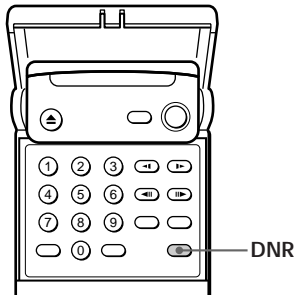

Press DNR. Each time you press the button, the value for DNR changes as follows:

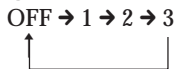

As the value increases, the picture noise will be reduced. However, afterimages may increase.

### Notes

- Depending on the disc, the effect may be difficult to tell.
- The setting for DNR returns to OFF when:
  - you turn the power off
  - you open or close the disc tray

## Changing the Sounds



With DVDs on which multilingual sounds are recorded, you can select the language you want while playing the DVD.

With multiplex VIDEO CDs, you can select the sound from the right or left channel and listen to the sound of the selected channel through both the right and left speakers. In this case, the sound loses the stereo effect.

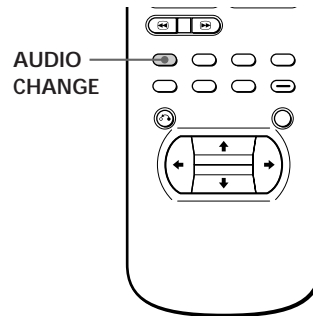

Press AUDIO CHANGE while playing a disc. Each time you press the button, the indication and the language/sound from the speakers change as follows:

### ■ When playing a DVD

AUDIO 1 → AUDIO 2 → .....



AUDIO 1: ENGLISH

### ■ When playing a VIDEO CD or a CD

Press	Indication	You will hear
Once	1/L	The sound of the left channel
Twice	2/R	The sound of the right channel
Three times	1/L 2/R	The standard stereo sound



You can also use the menu to switch the sound for the VIDEO CD or the CD

Press MENU to display the menu. Then select "L/R/STEREO" in "CUSTOM SETUP" to change the sound (page 43).

### Notes

- Depending on the DVD, you may not be able to change the languages even if multilingual sounds are recorded on the DVD.
- If "DOLBY DIGITAL MODE" is set to "2" (page 43), the Dolby Digital (AC-3) format audio is played when:
  - you open or close the disc tray
  - you release Resume Play

## Turning the Sub-titles On and Off

With DVDs on which sub-titles are recorded, you can turn the sub-titles on and off whenever you want while playing the DVD.

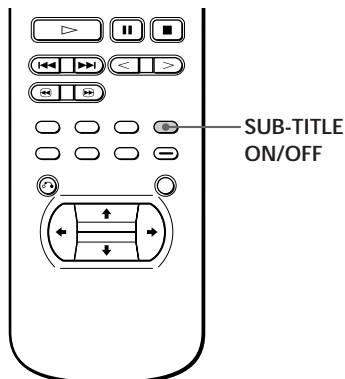

Press SUB-TITLE ON/OFF while playing a DVD. Sub-titles appear on the TV screen.

To turn off the sub-titles  
Press SUB-TITLE ON/OFF again.

### Notes

- When playing the DVD on which no sub-titles are recorded, no sub-titles appear even if you press SUB-TITLE ON/OFF.
- Depending on the DVD, you may not be able to turn the sub-titles on even if they are recorded on the DVD.
- Depending on the DVD, you may not be able to turn the sub-titles off.

## Changing the Sub-titles

With DVDs on which multilingual sub-titles are recorded, you can change the sub-titles whenever you want while playing the DVD.

When sub-titles are turned off, press SUB-TITLE ON/OFF to turn on the sub-titles.

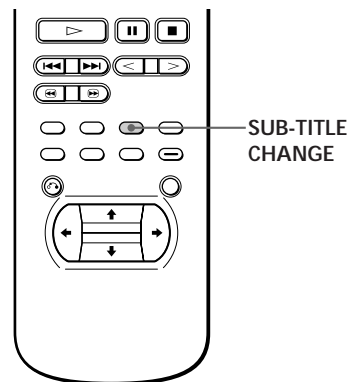

While playing a DVD, press SUB-TITLE CHANGE repeatedly until the sub-titles you want appear on the TV screen.

SUB-TITLE 1 → SUB-TITLE 2 → ... → AUDIO FOLLOW \*

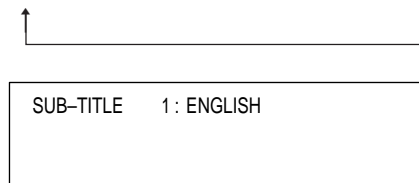

\* When you select "AUDIO FOLLOW," the language for the sub-titles change according to the language for the sound.

### Notes

- The type and number of languages for sub-titles vary from disc to disc.
- Depending on the DVD, you may not be able to change the sub-titles even if multilingual subtitles are recorded on the DVD.
- Depending on the DVD, you may not change the sub-titles following the language for the sound, even if "AUDIO FOLLOW" is displayed.

## Changing the Angles

With DVDs on which various angles (multi-angles) for a scene are recorded, you can change the angles whenever you want while playing the DVD.

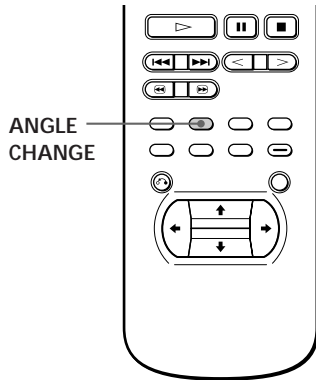

When "ANGLE" appears on the front panel display while playing a DVD, press ANGLE CHANGE repeatedly until you get the angle you want.

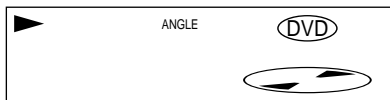

ANGLE 1 → ANGLE 2 → ...



### You can specify the angle beforehand

Specify the angle when "ANGLE" is not displayed on the front panel display. When a scene on which multi-angles are recorded comes, the angle is automatically selected.

### Notes

- The number of angles varies from disc to disc or from scene to scene. The number of angles that can be changed on a scene is that of angles recorded for that scene.
- Depending on the DVD, you may not be able to change the angles even if multi-angles are recorded on the DVD.

## Controlling the TV with the Supplied Remote

You can control Sony TVs with the  mark using the supplied remote.

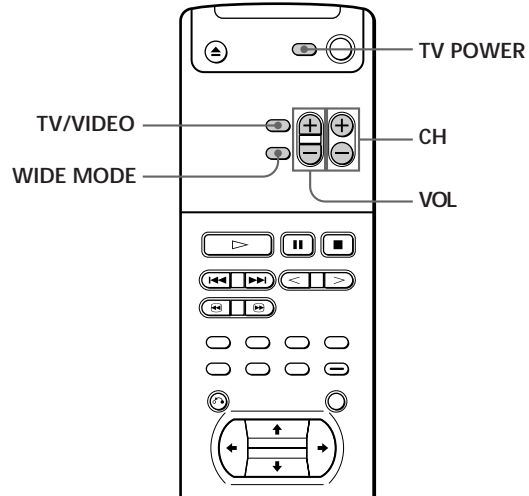

By pressing	You can
TV POWER	Turn on or off the TV
TV/VIDEO	Select the input source for the TV
WIDE MODE	Switches the wide mode of the TV
VOL	Adjust the volume of the TV
CH	Change the channel of the TV



## Using the Menu

Using the menu allows initial setup, selecting the play mode, adjusting the picture and sound quality, setting the various outputs, etc. You can also set a language for the sub-titles and menu display, etc.

For details on each menu item, see pages 41 to 44.

In the menu, select the item or setting from left to right. Use  $\rightarrow$  to go to the right item or setting. Use  $\leftarrow$  to go back to the left item or setting.

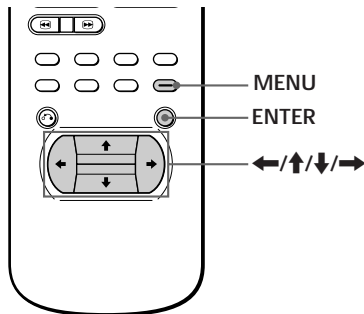

- 1 Press MENU to display the menu on the TV screen.

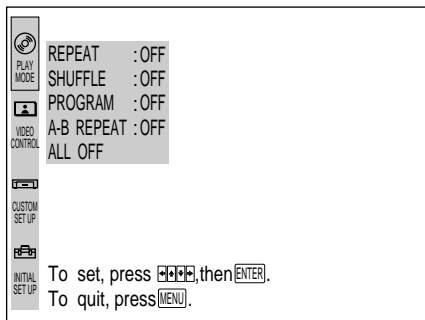

- 2 Select the main item you want using  $\uparrow/\downarrow$ , and then press  $\rightarrow$  or ENTER. The selected main item is highlighted.

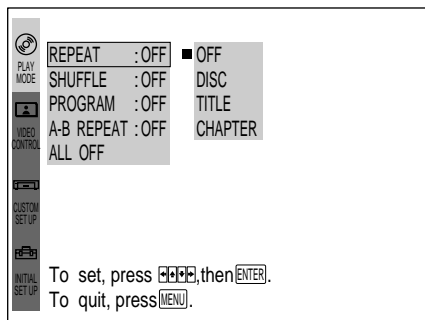

- 3 Select the item you want using  $\uparrow/\downarrow$ , then press  $\rightarrow$  or ENTER.

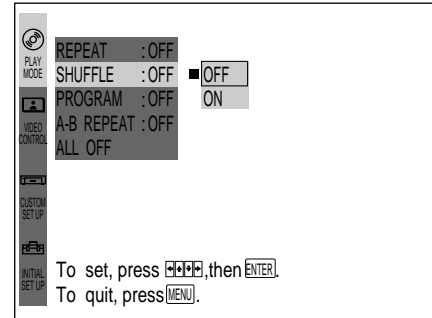

- 4 Select the setting you want using  $\uparrow/\downarrow$ , then press ENTER.

A check mark (■) appears on the left of the selected setting.

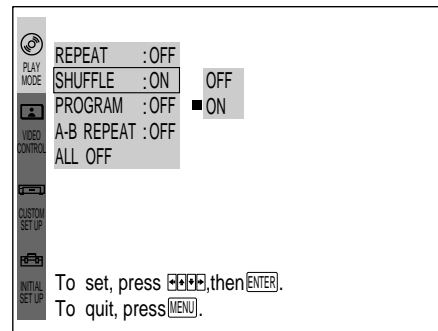

When  $\rightarrow$  appears on the right of "ADJUST"

- 1 Select "ADJUST," then press  $\rightarrow$  or ENTER.

The display for adjustment appears.

- 2 Adjust the value using  $\leftarrow/\rightarrow$ , then press ENTER.

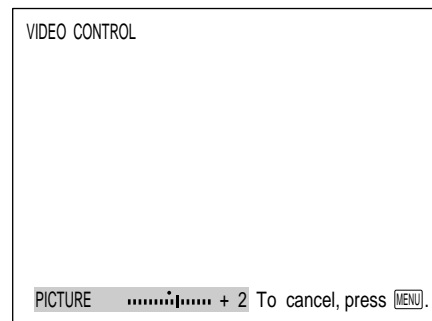

When  $\rightarrow$  appears on the right of the setting

More settings to be selected are on the right. Press  $\rightarrow$  to select.

To cancel using the menu on the way

Press MENU.

### Note

Some menu items require operations other than selecting the setting. For details on these items, see the relevant pages.

## Settings for Playback (PLAY MODE)

“PLAY MODE” allows you to set various playback modes as described on pages 32 to 36. Default settings are underlined>.

### Notes

- Depending on the disc, you may not be able to set playback modes.
- You can set Shuffle, Program and Repeat Play only during stop for VIDEO CDs with PBC functions.

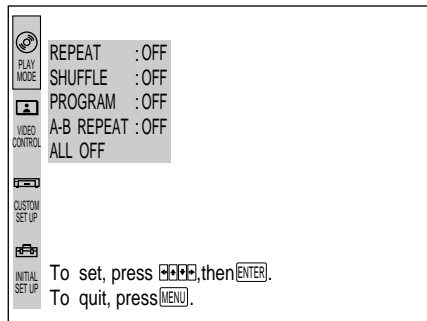

### ■ REPEAT (page 32)

Selects the setting of Repeat Play.

- OFF: does not play repeatedly.
- DISC: repeats all the titles/all the chapters/all the tracks on a disc.
- TITLE (DVD only): repeats the current title.
- CHAPTER (DVD only): repeats the current chapter.
- TRACK (VIDEO CD/CD only): repeats the current track.

### ■ SHUFFLE (page 34)

Selects the setting of Shuffle Play.

- OFF: does not play a disc in random order.
- ON: has the player “shuffle” titles or tracks and play in a random order.

### ■ PROGRAM (page 34)

Selects the setting of Program Play.

- OFF: The order of the titles, chapters or tracks on the disc cannot be arranged.
- SET: arranges the order of the titles, chapters or tracks on the disc.
- ON: plays the titles, chapters or tracks in the programmed order.

### ■ A-B REPEAT (page 33)

Selects the setting of A↔B Repeat.

- OFF: does not play a specific portion of a title/chapter/track repeatedly.
- SET: sets the A and B points.
- ON: plays a specific portion of a title/chapter/track repeatedly.

### ■ ALL OFF

Turns off all the settings in “PLAY MODE.” Select this item in Continuous Play mode.



You can do Disc Repeat Play or Shuffle Play in the programmed order

When “PROGRAM” is set to “ON,” set “REPEAT” to “DISC” or set “SHUFFLE” to “ON.”

## Adjustments for Playback Picture (VIDEO CONTROL)

“VIDEO CONTROL” allows you to adjust the video output of the DVD or VIDEO CD from the player, not from the TV, to obtain the picture quality you want. When you select “ADJUST” in a menu item, adjust the value using ←/→, then press ENTER. Default adjustments are underlined.

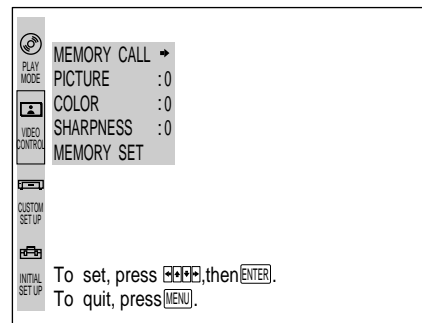

### ■ MEMORY CALL

At factory setting, typical adjustments are saved in memory.

To adjust the picture using these adjustments, select this menu item to call any one of the sets.

When you change the settings of the menu items in “VIDEO CONTROL,” you can save up to 3 sets of your own adjustments in memory (“MEMORY SET”). To call these settings, select this menu item.

- CALL→:
  - 1: to view the picture with the best possible sharpness and contrast in a well-lit room
  - 2: to view the quiet picture in a dark room
  - 3: to make adjustments to obtain the picture you want. (All the setting values are 0.)
  - STANDARD: All the setting values are 0.

### ■ PICTURE

Adjusts the picture contrast. The higher the value is, the stronger the contrast.

- ADJUST→ –5 ~ 0 ~ 5: adjusts the value for the picture contrast.
- 0 RESET: resets the value to “0.”

### ■ COLOR

Adjusts the picture color intensity. The higher the value is, the stronger the intensity.

- ADJUST→ –5 ~ 0 ~ 5: adjusts the value for the picture color intensity.
- 0 RESET: resets the value to “0.”

### ■ SHARPNESS

Adjusts the picture sharpness. The higher the value is, the sharper the picture.

- ADJUST→ –5 ~ 0 ~ 5: adjusts the value for the picture sharpness.
- 0 RESET: resets the value to “0.”

### ■ MEMORY SET

Saves up to 3 sets of your own adjustments of "VIDEO CONTROL" in memory.

- **RESET:** resets all the sets of the adjustments saved in memory to the factory setting.
- **1:** saves the current set of your own adjustments in memory "1."
- **2:** saves the current set of your own adjustments in memory "2."
- **3:** saves the current set of your own adjustments in memory "3."

### Note

Depending on the DVD or VIDEO CD, the effects of the adjustments may be difficult to see.

## Settings for Display and Sound (CUSTOM SETUP)

"CUSTOM SETUP" allows you to set the display and sound according to the playback conditions.

Default settings are underlined.

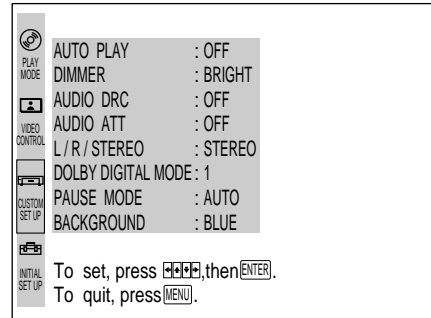

### ■ AUTO PLAY

Selects the setting of Auto Play when you connect the AC power cord to the AC outlet.

- **OFF:** does not start playing a disc automatically.
- **TIMER:** starts playing a disc automatically when you connect the AC power cord to the AC outlet. By connecting a timer (not supplied), you can start playing at any time you want.
- **DEMO1:** starts playing the demonstration 1 automatically.
- **DEMO2:** starts playing the demonstration 2 automatically.

### ■ DIMMER

Adjusts the lighting of the front panel display.

- **BRIGHT:** makes the front panel display bright.
- **DARK:** makes the front panel display dark.
- **OFF:** turns off the lighting of the front panel display.

### ■ AUDIO DRC (Dynamic Range Control)

Controls the audio dynamic range when you play a DVD.

This functions only for the sound from the DIGITAL OUT connectors and from the LINE OUT (AUDIO 1, 2) connectors when "DVD DIGITAL OUT" is set to "PCM". (page 44)

- **OFF:** Normally select this position.
- **ON:** makes the sound clear with the volume turned down at night, etc.

### Note

When you play DVDs without the AUDIO DRC function, there may be no effect on the sound.

## ■ AUDIO ATT (attenuation)

Selects the setting of the output from the LINE OUT (AUDIO 1, 2) connectors according to audio equipment to be connected.

- OFF: turns off the audio attenuation.
- ON: drops the audio output level so that no sound distortion occurs.

### Note

The setting does not affect the output from the DIGITAL OUT connectors.

## ■ L/R/STEREO

Selects the setting of the sound of the VIDEO CD from the LINE OUT (AUDIO 1, 2) and DIGITAL OUT connectors or the sound of the CD from the LINE OUT (AUDIO 1, 2) connectors.

- STEREO: outputs the standard stereo sound.
- L: outputs the sound from the left channel.
- R: outputs the sound from the right channel.

### Note

The sound is output in stereo from the DIGITAL OUT connectors when you play a CD.

## ■ DOLBY DIGITAL MODE

Gives the Dolby Digital (AC-3) format priority when you play a DVD on which multiple audio formats are recorded.

- 1: No priority given.
- 2: Priority given.

### Notes

- If "DOLBY DIGITAL MODE" is set to "2," the Dolby Digital (AC-3) format audio is played when:
  - you open or close the disc tray
  - you release Resume Play
 Depending on the DVD, the sound may be switched to another channel or another language.
- If multiple audio channels are recorded in Dolby Digital (AC-3) format, the highest channel audio recorded in Dolby Digital (AC-3) format is played.
- Depending on the DVD, the audio with priority may be predetermined. In this case, you cannot give priority to the Dolby Digital (AC-3) format by selecting "2."

## ■ PAUSE MODE

Selects the picture in pause mode.

- AUTO: A picture including subjects that move dynamically is output with no jitter. Normally select this position.
- FRAME: A picture including subjects do not move dynamically is output with high resolution.

### Notes

- The setting does not affect the picture when the auto pause functions while playing the DVD.
- When "PAUSE MODE" is set to "FRAME," the picture may jitter in Slow-motion Play mode.

## ■ BACKGROUND

Selects the background color of the TV screen in stop mode.

- BLUE: The background color is blue.
- BLACK: The background color is black.

## Basic Settings (INITIAL SETUP)

"INITIAL SETUP" allows necessary setup when you install the player and connect external components to the player. The setups for advanced playback of DVDs or VIDEO CDs are also available in this main menu. Default settings are underlined.

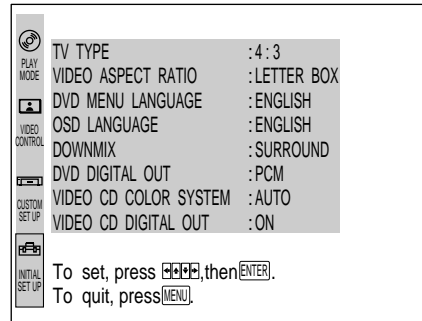

## ■ TV TYPE

Selects the aspect ratio of the TV to be connected.

- 4:3: when you connect a normal TV to the player
- 16:9: when you connect a wide-screen TV to the player

## ■ VIDEO ASPECT RATIO

Selects the aspect ratio of the screen when you play a wide picture recorded on a DVD on the normal TV.

- LETTER BOX: displays the wide picture with bands displayed on the upper and lower portions of the screen.
- PAN SCAN: displays the wide picture on the whole screen with portions automatically cut off.



### Note

Depending on the DVD, the aspect ratio of the playback picture may be fixed.

### ■ DVD MENU LANGUAGE

Switches the languages for the DVD menu which is recorded in multiple languages.

- ENGLISH
- CHINESE
- SPANISH
- JAPANESE
- FRENCH
- ITALIAN
- GERMAN
- PORTUGUESE
- DUTCH
- OTHERS →

When you select "OTHERS," select and enter the language code from the list using the number buttons (page 52).

### Note

When you select the language that is not recorded on the DVD, any one of the recorded languages is automatically selected.

### ■ OSD (On-Screen Display) LANGUAGE

Switch the language for the on-screen display.

- ENGLISH
- CHINESE

### ■ DOWNMIX

Switches the mixing down methods when you play a DVD on which the sound in Dolby Digital (AC-3) format is recorded.

- SURROUND: when the player is connected to an audio component that conforms to Dolby surround, Dolby Pro Logic surround, etc.
- NORMAL : when the player is connected to a normal audio component

 The setting affects the analog output from the LINE OUT (AUDIO 1, 2) connectors and digital output from the DIGITAL OUT OPTICAL and COAXIAL connectors when "DVD DIGITAL OUT" is set to "PCM."

### ■ DVD DIGITAL OUT

Switches the outputting methods of audio signals from the DIGITAL OUT OPTICAL and COAXIAL connectors on the rear panel of the player.

- PCM: when the player is connected to an audio component without a built-in Dolby Digital (AC-3) decoder
- AC-3 Digital: when the player is connected to audio component with a built-in Dolby Digital (AC-3) decoder

### Note

Select the setting correctly. Otherwise, no sound will come out from the speakers or strange sound will come out from the speakers, affecting your ears or causing the speakers to be damaged.

### ■ VIDEO CD COLOR SYSTEM

Selects the color system when you play a VIDEO CD.

- AUTO: automatically selects the appropriate color system for the VIDEO CD.
- PAL: selects the PAL color system.
- NTSC: selects the NTSC color system.

For details on selecting the color system, see page 9.

### ■ VIDEO CD DIGITAL OUT

Turns on and off the digital audio output when you play a VIDEO CD.

- ON: outputs the digital audio signals.
- OFF: does not output the digital audio signals.

### Precautions

#### On safety

- Caution – The use of optical instruments with this product will increase eye hazard.
- Should any solid object or liquid fall into the cabinet, unplug the player and have it checked by qualified personnel before operating it any further.

#### On power sources

- The player is not disconnected from the AC power source (mains) as long as it is connected to the wall outlet, even if the player itself has been turned off.
- If you are not going to use the player for a long time, be sure to disconnect the player from the wall outlet. To disconnect the AC power cord (mains lead), grasp the plug itself; never pull the cord.
- Should the AC power cord (mains lead) need to be changed, have it done at a qualified service shop only.

#### On placement

- Place the player in a location with adequate ventilation to prevent heat build-up in the player.
- Do not place the player on a soft surface such as a rug that might block the ventilation holes on the bottom.
- Do not place the player in a location near heat sources, or in a place subject to direct sunlight, excessive dust or mechanical shock.

#### On operation

- If the player is brought directly from a cold to a warm location, or is placed in a very damp room, moisture may condense on the lenses inside the player. Should this occur, the player may not operate properly. In this case, remove the disc and leave the player turned on for about 30 minutes until the moisture evaporates.

#### On adjusting volume

- Do not turn up the volume while listening to a portion with very low level inputs or no audio signals. If you do, the speakers may be damaged when a peak level portion is played.

#### On cleaning

- Clean the cabinet, panel and controls with a soft cloth slightly moistened with a mild detergent solution. Do not use any type of abrasive pad, scouring powder or solvent such as alcohol or benzene.

If you have any questions or problems concerning your player, please consult your nearest Sony dealer.

#### IMPORTANT NOTICE

**Caution:** The enclosed DVD Player is capable of holding a still video image or Menu image on your television screen indefinitely. If you leave the still video image or Menu image displayed on your TV for an extended period of time you risk permanent damage to your television screen. Projection televisions are very susceptible.

### Notes on Discs

#### On handling discs

- To keep the disc clean, handle the disc by its edge. Do not touch the surface.
- Do not stick paper or tape on the disc. If there is glue (or a similar substance) on the disc, remove the glue completely before using the disc.

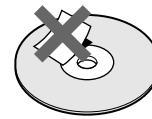
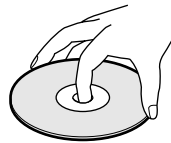

Not this way

- Do not expose the disc to direct sunlight or heat sources such as hot air ducts, or leave it in a car parked in direct sunlight as there can be considerable rise in temperature inside the car.
- After playing, store the disc in its case.

#### On cleaning

- Before playing, clean the disc with a cleaning cloth. Wipe the disc from the center out.

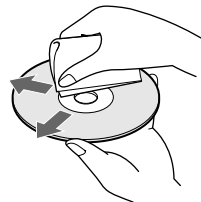

- Do not use solvents such as benzene, thinner, commercially available cleaners or anti-static spray intended for vinyl LPs.

## Troubleshooting

If you experience any of the following difficulties while using the player, use this troubleshooting guide to help you remedy the problem. Should any problem persist, consult your nearest Sony dealer.

The power is not turned on.

- ➔ If the ON/STANDBY indicator is not lit, check that the AC power cord is connected securely.

There is no picture.

- ➔ Check that the player is connected securely.
- ➔ The video connecting cord has broken down. Replace it with a new one.
- ➔ Make sure you connect the player to the video input connector on the TV. (page 6)
- ➔ Make sure you turn on the TV.
- ➔ Make sure you select the video input on the TV so that you can view the pictures from the player.

There is no sound.

- ➔ Check that the player is connected securely.
- ➔ The audio connecting cord has broken down. Replace it with a new one.
- ➔ Make sure you connect the player to the audio input connectors on the amplifier. (page 6)
- ➔ Make sure you turn on the TV and the amplifier.
- ➔ Make sure you select the appropriate position on the amplifier so that you can listen to the sound from the player.
- ➔ The player is in pause mode or in Slow-motion Play mode. Press ▷ to return to normal play mode.
- ➔ Fast forward (FF1 or FF2) or fast reverse (FR1 or FR2) is performed. Press ▷ to return to normal play mode.
- ➔ When you connect the player to an amplifier with a digital connector and play a DVD, set "DVD DIGITAL OUT" in "INITIAL SETUP" to "PCM" in the menu. When you play a VIDEO CD, set "VIDEO CD DIGITAL OUT" in "INITIAL SETUP" to "ON" in the menu.
- ➔ Select the appropriate setting of "DOWNMIX" in "INITIAL SETUP" for your amplifier.

The remote does not function.

- ➔ Remove any obstacles between the remote and the player.
- ➔ Use the remote near the player.
- ➔ Point the remote at the remote sensor  on the player.
- ➔ Replace all the batteries in the remote with new ones if they are weak.

The picture noise appears.

- ➔ Clean the disc.
- ➔ This player features the copy protection function developed by Macrovision. Copy protection signals are recorded on some DVDs. When you play these discs, the picture noise will appear on some TVs and projectors.
- ➔ The picture noise appears when the player is connected to the TV via the video deck. Do not connect the player to the video deck. Connect the player directly to the TV. (page 7)

The picture noise appears when you record and play the picture of the DVD on a video deck.

- ➔ This player features the copy protection function developed by Macrovision. Copy protection signals are recorded on some DVDs. When you play and record the pictures of these discs on a video deck, the picture noise appears.

The sound noise comes out.

- ➔ Clean the disc.
- ➔ Connect the audio plug of the connecting cord firmly.

The disc does not play.

- ➔ There is no disc inside ("INSERT DISC" appears on the TV screen). Insert a disc.
- ➔ Insert the disc with the playback side facing down on the disc tray correctly.
- ➔ Place the disc on the disc tray correctly.
- ➔ Clean the disc.
- ➔ The player cannot play CD-ROMs, etc. (page 5) Insert a DVD, a VIDEO CD, or CD.
- ➔ Check the region code of the DVD. (page 4)
- ➔ Moisture has condensed inside the player. Remove the disc and leave the player turned on for about 30 minutes. (page 45)

The player does not play from the beginning when playing a disc.

- ➔ Any menu items in "PLAY MODE" are set to "ON." Select "ALL OFF." (page 41)
- ➔ Resume Play is performed. Press ■ on the front panel or on the remote before you start playing. (page 36)
- ➔ A title menu or a DVD menu automatically appears on the TV screen when you play your DVD, or a menu screen automatically appears on the TV screen when you play your VIDEO CD with PBC functions.

The player starts playing the DVD automatically.

- ➔ The DVD features the auto playback function.

Stopping playback, Search, Slow-motion Play, Repeat Play, Shuffle Play or Program Play, etc. cannot be performed.

- ➔ Depending on the disc, you may not do some of the operations above.



Messages do not appear on the TV screen in the language you want.

- ➔ In the menu, select the language for the on-screen display in "OSD LANGUAGE" in "INITIAL SETUP." (page 44)

The language for the sound cannot be changed when you play a DVD.

- ➔ Multilingual sound is not recorded on the DVD.
- ➔ Changing the language for the sound is prohibited on the DVD.

The language for the sub-titles cannot be changed when you play a DVD.

- ➔ Multilingual sub-titles are not recorded on the DVD.
- ➔ Changing the language for the sub-titles is prohibited on the DVD.

The sub-titles cannot be turned off when you play a DVD.

- ➔ Depending on the DVD, you may not be able to turn the sub-titles off.

The angles cannot be changed when you play a DVD.

- ➔ Multi-angles are not recorded on the DVD.
- ➔ Change the angles when "ANGLE" appears on the front panel display. (page 39)
- ➔ Changing the angles is prohibited on the DVD.

The aspect ratio of the screen cannot be changed though you set "VIDEO ASPECT RATIO" in "INITIAL SETUP" in the menu when you play a wide picture.

- ➔ The aspect ratio is fixed on your DVD.

The menu screen does not appear when you play a VIDEO CD.

- ➔ The VIDEO CD does not feature PBC functions.
- ➔ Follow the correct operating procedure. (Also refer to the instructions supplied with the disc.)

The sound loses stereo effect when you play a VIDEO CD or a CD.

- ➔ "1/L" or "2/R" appears on the front panel display.  
On the remote, press AUDIO CHANGE repeatedly until "1/L 2/R" appears. (page 37)  
In the menu, set "L/R/STEREO" in "CUSTOM SETUP" to "STEREO." (page 42)

The player does not operate properly.

- ➔ Static electricity, etc. may affect the player's operation.  
Disconnect the AC power cord once, then connect it again.

The picture jitters in Slow-motion Play mode.

- ➔ In the menu, set "PAUSE MODE" in "CUSTOM SETUP" to "AUTO." (page 43)

The power is turned off automatically.

- ➔ The Auto Power Off function is activated. (If you do not operate the player or the remote for more than 30 minutes when a disc is not being played, the power will be automatically turned off.)

## Specifications

### CD/DVD player

Laser	Semiconductor laser
Signal format system	NTSC (for DVD and VIDEO CD) PAL (for VIDEO CD)

### Audio characteristics

Frequency response	DVD (PCM): 2 Hz to 22 kHz (±0.5 dB) CD: 2 Hz to 20 kHz (±0.5 dB)
Signal-to-noise ratio	More than 107 dB
Harmonic distortion	Less than 0.0028 %
Dynamic range	More than 97 dB
Wow and flutter	Less than detected value (±0.001% W PEAK)

### Outputs and inputs

	Jack type	Maximum output level	Load impedance
LINE OUT (AUDIO 1, 2)	Phono jacks	2 Vrms (at 50 kilohms)	Over 10 kilohms
DIGITAL OUT (OPTICAL)	Optical output connector	-18 dBm	Wave length: 660 nm
DIGITAL OUT (COAXIAL)	Phono jacks	0.5 Vp-p	75 ohms terminated
LINE OUT (VIDEO)	Phono jack	1.0 Vp-p	75 ohms, sync negative
S VIDEO OUT	4-pin mini DIN	Y: 1.0 Vp-p C: 0.286 Vp-p	75 ohms, sync negative 75 ohms terminated

### General

Power requirements	220 to 240 V AC, 50 Hz
Power consumption	26 W
Dimensions (approx.)	430 × 111 × 395 mm (w/h/d) incl. projecting parts
Mass (approx.)	6.0 kg
Operating temperature	5 °C to 35 °C
Operating humidity	5 % to 90 %

### Supplied accessories

See page 6.

Design and specifications are subject to change without notice.



### Glossary

#### Bit rate

Value indicating the amount of video data compressed in a DVD per second. The unit is Mbps (Mega bit per second). 1 Mbps indicates that the data per second is 1,000,000 bits. The higher the bit rate is, the larger the amount of data. However, this does not always mean that you can get higher quality pictures.

#### Chapter

Sections of a picture or a music piece on a DVD that are smaller than titles. A title is composed of several chapters. Each chapter is assigned a chapter number enabling you to locate the chapter you want.

#### Dolby Digital (AC-3)

Digital audio compression technology that the Dolby Laboratories Corporation developed. This technology conforms to 5.1-channel surround. When connecting a component with a built-in Dolby Digital decoder, you can enjoy more real audio presence.

#### DVD

A disc that contains up to 8 hours of moving pictures even though its diameter is the same as a CD. The data capacity of a single-layer and single-sided DVD, at 4.7 GB (Giga Byte), is 7 times that of a CD. Furthermore, the data capacity of a dual-layer and single-sided DVD is 8.5 GB, a single-layer and double-sided DVD 9.4 GB, and a dual-layer and double-sided DVD 17 GB.

The picture data uses the MPEG 2 format, one of the worldwide standards of digital compression technology. The picture data is compressed to 1/40 of its original size. The DVD also uses the variable rate coding technology that changes the data to be allocated according to the status of the picture.

The audio data is recorded in Dolby Digital (AC-3) as well as in PCM, allowing you to enjoy more real audio presence.

Furthermore, various advanced functions such as the multi-angle and multilingual functions are provided with the DVD.

#### Multi-angle function

Various angles, or viewpoints of the video camera, for a scene are recorded on some DVDs.

#### Multilingual function

Several languages for the sound or sub-titles in a picture are recorded on some DVDs.

#### Playback Control (PBC)

Signals encoded on VIDEO CDs (Version 2.0) to control playback.

By using menu screens recorded on VIDEO CDs with PBC functions, you can enjoy playing simple interactive programs, programs with search functions, and so on.

#### Title

The longest sections of a picture or a music piece on a DVD; a movie, etc. for a picture piece on a video software or an album, etc. for a music piece on an audio software. Each title is assigned a title number enabling you to locate the title you want.

#### Track

Sections of a picture or a music piece on a CD or VIDEO CD. Each track is assigned a track number enabling you to locate the track you want.

#### VIDEO CD

A compact disc that contains moving pictures. The picture data uses the MPEG 1 format, one of the worldwide standards of digital compression technology. The picture data is compressed 1/140 of its original size. Consequently, a 12 cm VIDEO CD can contain up to 74 minutes of moving pictures. VIDEO CDs also contain compressed audio information. Sounds outside the range of human hearing are compressed while the sounds we can hear are not compressed. VIDEO CDs can hold 6 times the audio information of conventional audio CDs. There are 2 versions of VIDEO CDs.

- Version 1.1: You can play only moving pictures and sounds.
  - Version 2.0: You can play high-resolution still pictures and enjoy PBC functions.
- This player conforms to both versions.

## Index to Parts and Controls

Refer to the pages indicated in parentheses for details.

### Front Panel

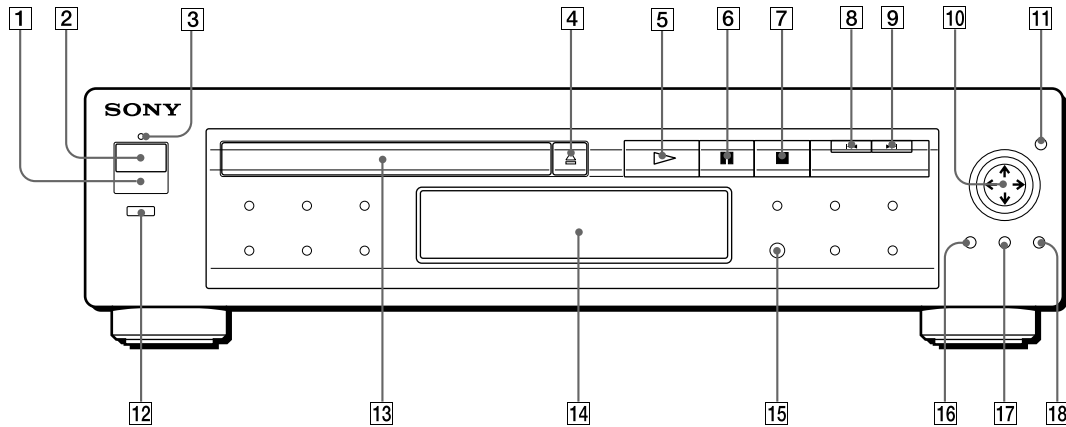

- 1** (remote sensor) (6)  
Accepts the remote control signals.
- 2** **POWER** switch (10, 18, 26)  
Turns on and off the power of the player.
- 3** **ON/STANDBY** indicator (10, 18, 26)  
Lights in red in standby mode, changes to green when you turn on the power.
- 4** **OPEN/CLOSE** button (11, 19, 27)  
Opens or closes the disc tray.
- 5** **PLAY** button (10, 18, 26)  
Plays a disc.
- 6** **PAUSE** button (11, 19, 27)  
Pauses playing a disc.
- 7** **STOP** button (11, 19, 27, 36)  
Stops playing a disc.
- 8** **PREV** button (12, 20, 28)  
Press to go back to the preceding chapter or track.
- 9** **NEXT** button (12, 20, 28)  
Press to go to the next chapter or track.
- 10** **←/↑/↓/→** buttons  
Selects the items or settings.
- 11** **ENTER** button  
Executes the items or settings.
- 12** **MENU** button (40)  
Displays the menu on the TV screen to set or adjust the menu items.
- 13** **Disc tray** (10, 18, 26)  
Place a disc on the tray.
- 14** **Front Panel Display** (16, 24, 30)  
Indicates the playing time, etc.
- 15** **DNR** button (37)  
Reduces the picture noise.
- 16** **TITLE** button (13)  
Displays the title menu on the TV screen.
- 17** **DVD MENU** button (14)  
Displays the DVD menu on the TV screen.
- 18** **RETURN** button (21)  
Press to return to the preceding selection screen, etc.

### Rear Panel

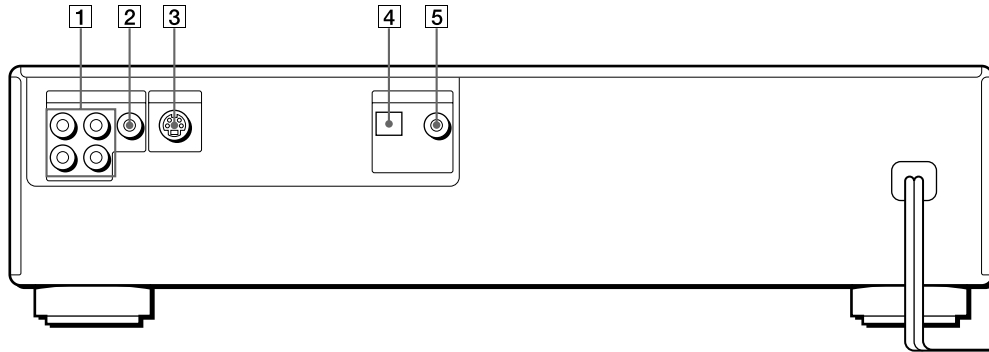

- 1** LINE OUT (AUDIO 1, 2) connector (7)  
Connects to the audio input connector on the TV or amplifier.
- 2** LINE OUT (VIDEO) connector (7)  
Connects to the video input connector on the TV or monitor.
- 3** S VIDEO OUT connector (7)  
Connects to the S video input connector on the TV or VCR.
- 4** DIGITAL OUT (OPTICAL) connector (8)  
Connects to an audio component using the optical cable.
- 5** DIGITAL OUT (COAXIAL) connector (8)  
Connects to an audio component using the coaxial cable.

Remote

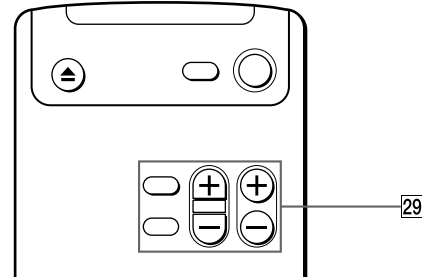
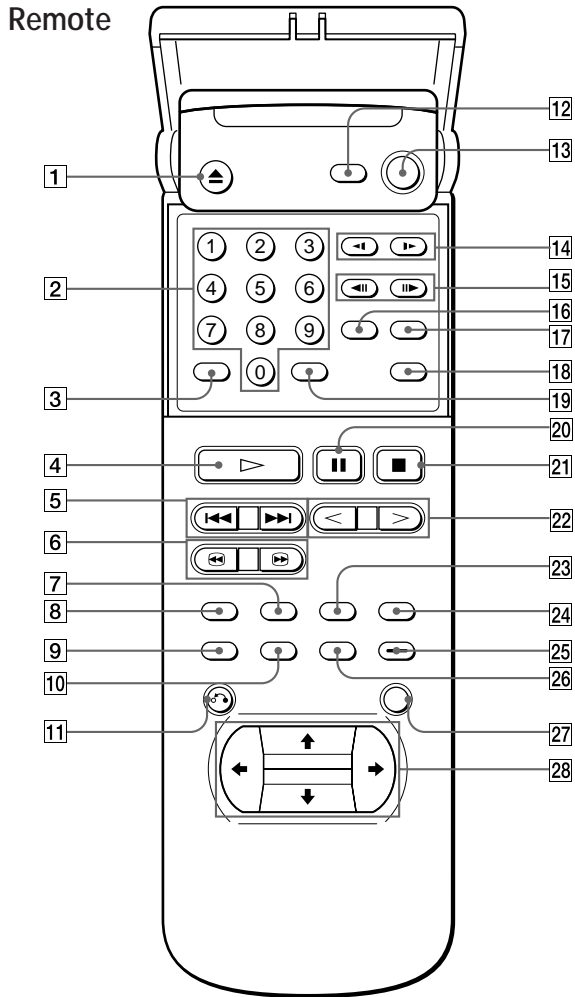

- 1** ▲OPEN/CLOSE button (11, 19, 27)  
Opens or closes the disc tray.
- 2** Number buttons (12, 20, 28)  
Selects the items or settings.
- 3** CLEAR button (12, 20, 28)  
Cancels the number selected with the number buttons.
- 4** ▷PLAY button (10, 18, 26)  
Plays a disc.
- 5** I◀◀/▶▶I PREV/NEXT buttons (12, 20, 28)  
Press to go to the next chapter or track or to go back to the preceding chapter or track.
- 6** ◀/▶SCAN buttons (12, 20, 28)  
Locates a point while monitoring the picture or sound.
- 7** ANGLE CHANGE button (39)  
Changes the angles when playing a DVD.
- 8** AUDIO CHANGE button (37)  
Changes the sound while playing a DVD or VIDEO CD or AUDIO CD.
- 9** DISPLAY button (15, 22, 29)  
Displays the current playing status on the TV screen.
- 10** TITLE button (13)  
Displays the title menu on the TV screen.
- 11** ⏪/⏩ RETURN button (21)  
Press to return to the preceding selection screen while playing a VIDEO CD with PBC functions.
- 12** TV POWER button (39)  
Turns the TV power on and off.
- 13** POWER button (10, 18, 26)  
Turns on and off the power of the player.
- 14** ◀◀/▶▶ SLOW buttons (11, 19)  
Plays a disc in slow motion.
- 15** ◀◀◀/▶▶▶ STEP buttons (11, 19)  
Plays a disc frame by frame.
- 16** SEARCH MODE button (12, 20, 28)  
Press to select the unit for search (track, index, etc.)
- 17** TIME button (16, 24, 30)  
Displays the playing time of the disc, etc. on the front panel display.
- 18** DNR button (37)  
Reduces the picture noise.
- 19** ENTER button (13)  
Executes the items or settings.
- 20** ■■PAUSE button (11, 19, 27)  
Pauses playing a disc.
- 21** ■STOP button (11, 19, 27)  
Stops playing a disc.
- 22** </> buttons (11)  
Plays a disc at about twice the normal speed.
- 23** SUB-TITLE CHANGE button (38)  
Changes the sub-titles when playing a DVD.
- 24** SUB-TITLE ON/OFF button (38)  
Turns the sub-titles on and off when playing a DVD.
- 25** MENU button (40)  
Displays the menu on the TV screen to set or adjust the menu items.
- 26** DVD MENU button (14)  
Displays the DVD menu on the TV screen.
- 27** ENTER button  
Executes the items or settings.
- 28** ◀/↑/↓/▶ buttons  
Selects the items or settings.
- 29** TV operation buttons (39)  
Controls Sony TVs.

## Language Code List

For details, see page 44.

The language spellings conform to the ISO 639: 1988 (E/F) standard. (December 1996)

Code	Language	Code	Language	Code	Language	Code	Language
1027	Afar	1186	Scots Gaelic	1350	Malayalam	1513	Siswati
1028	Abkhazian	1194	Galician	1352	Mongolian	1514	Sesotho
1032	Afrikaans	1196	Guarani	1353	Moldavian	1515	Sundanese
1039	Amharic	1203	Gujarati	1356	Marathi	1516	Swedish
1044	Arabic	1209	Hausa	1357	Malay	1517	Swahili
1045	Assamese	1217	Hindi	1358	Maltese	1521	Tamil
1051	Aymara	1226	Croatian	1363	Burmese	1525	Telugu
1052	Azerbaijani	1229	Hungarian	1365	Nauru	1527	Tajik
1053	Bashkir	1233	Armenian	1369	Nepali	1528	Thai
1057	Byelorussian	1235	Interlingua	1376	Dutch	1529	Tigrinya
1059	Bulgarian	1239	Interlingue	1379	Norwegian	1531	Turkmen
1060	Bihari	1245	Inupiak	1393	Occitan	1532	Tagalog
1061	Bislama	1248	Indonesian	1403	(Afan) Oromo	1534	Setswana
1066	Bengali; Bangla	1253	Icelandic	1408	Oriya	1535	Tonga
1067	Tibetan	1254	Italian	1417	Punjabi	1538	Turkish
1070	Breton	1257	Hebrew	1428	Polish	1539	Tsonga
1079	Catalan	1261	Japanese	1435	Pashto; Pushto	1540	Tatar
1093	Corsican	1269	Yiddish	1436	Portuguese	1543	Twi
1097	Czech	1283	Javanese	1463	Quechua	1557	Ukrainian
1103	Welsh	1287	Georgian	1481	Rhaeto-Romance	1564	Urdu
1105	Danish	1297	Kazakh	1482	Kirundi	1572	Uzbek
1109	German	1298	Greenlandic	1483	Romanian	1581	Vietnamese
1130	Bhutani	1299	Cambodian	1489	Russian	1587	Volapük
1142	Greek	1300	Kannada	1491	Kinyarwanda	1613	Wolof
1144	English	1301	Korean	1495	Sanskrit	1632	Xhosa
1145	Esperanto	1305	Kashmiri	1498	Sindhi	1665	Yoruba
1149	Spanish	1307	Kurdish	1501	Sangho	1684	Chinese
1150	Estonian	1311	Kirghiz	1502	Serbo-Croatian	1697	Zulu
1151	Basque	1313	Latin	1503	Singhalese	1703	Not specified
1157	Persian	1326	Lingala	1505	Slovak		
1165	Finnish	1327	Laothian	1506	Slovenian		
1166	Fiji	1332	Lithuanian	1507	Samoan		
1171	Faroese	1334	Latvian; Lettish	1508	Shona		
1174	French	1345	Malagasy	1509	Somali		
1181	Frisian	1347	Maori	1511	Albanian		
1183	Irish	1349	Macedonian	1512	Serbian		

## Index

## A

- A↔B Repeat 33
- Adjusting
  - volume 10, 18, 26
- Angle 39
- AUDIO ATT 43
- AUDIO DRC 42
- AUTO PLAY 42
- Auto pause 16, 24
- Auto Power Off 10, 18, 26, 47

## B

- Batteries 6
- Bit rate 16, 48

## C

- CD 26
- Changing
  - angles 39
  - sound 37
  - sub-titles 38
- Chapter 5, 48
- Connecting 6
- Continuous play
  - CD 26
  - DVD 10, 48
  - VIDEO CD 18
- CUSTOM SETUP 42

## D, E

- Display
  - front panel display 16, 24, 30
  - on-screen display 15, 22, 29
- Digital output 44
- Dolby Digital (AC-3) 8, 48
- DOLBY DIGITAL MODE 43
- DOWNMIX 44
- DNR 37
- DVD 10
- DVD menu 14
- DVD menu language 44

## F, G

- Fast Forward 12, 20, 28
- Fast Reverse 12, 20, 28
- Front panel display
  - CD 30
  - DVD 16
  - VIDEO CD 24

## H

- Handling discs 45
- Hi-speed search 12, 20, 28
- Hooking up 6

## I, J, K

- INITIAL SETUP 43

## L

- LETTER BOX 43
- Locating
  - a specific point 12, 20, 28
  - by monitoring 12, 20, 28
  - by observing the TV screen 12, 20

## M, N

- Memory 41
- Menu
  - CUSTOM SETUP 42
  - INITIAL SETUP 43
  - PLAY MODE 41
  - VIDEO CONTROL 41
  - usage 40
- Multi-angle 48
- Multilingual 48

## O

- On-screen display
  - CD 29
  - DVD 15
  - language 44
  - VIDEO CD 22

## P, Q

- PAN SCAN 43
- PBC Playback 5, 21, 48
- Playback
  - Continuous Play 10, 18, 26
  - Program Play 34
  - Repeat Play 32
  - Shuffle Play 34
- PLAY MODE 41
- Program Play 34

## R

- Remote control 6, 39
- Repeating
  - a specific portion 33
  - current title, chapter 32
  - current track 33
  - disc 32
- Resume Play 36

## S

- Scene 5
- Scene Search 20
- Searching. *See* Locating.
- Shuffle Play 34
- Slow-motion Play 11, 19
- S video output 7
- Sub-titles
  - changing 38
  - turning on and off 38

## T

- Title 5, 48
- Title menu 13
- Track 5, 48
- Troubleshooting 46

## U

- Usable discs 4

## V, W, X, Y, Z

- VIDEO CONTROL 41
- VIDEO CD 18, 48