

Video Cassette Recorder

Operating Instructions

Owner's record

The model and serial numbers are located at the rear of the unit. Record these numbers in the spaces provided below. Refer to them whenever you call upon your Sony dealer regarding this product.

Model No. _____

Serial No. _____



Hi-Fi



SLV-662HF 

SLV-679HF 

SLV-679HF PX

WARNING

To prevent fire or shock hazard, do not expose the unit to rain or moisture.

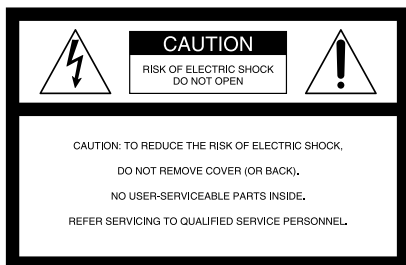

 This symbol is intended to alert the user to the presence of uninsulated “dangerous voltage” within the product’s enclosure that may be of sufficient magnitude to constitute a risk of electric shock to persons.

 This symbol is intended to alert the user to the presence of important operating and maintenance (servicing) instructions in the literature accompanying the appliance.

WARNING

The power cord must be changed only at a qualified service shop.

CAUTION (SLV-662HF/679HF)

To prevent electric shock, do not use this polarized AC plug with an extension cord, receptacle or other outlet unless the blades can be fully inserted to prevent blade exposure.

Precautions

Safety

- For SLV-662HF/679HF, operate the unit only on 120 V AC, 60 Hz. For SLV-679HF PX, operate the unit on 110 to 240 V AC, 50/60 Hz.
- If anything falls into the cabinet, unplug the unit and have it checked by qualified personnel before operating it any further.
- This unit is not disconnected from the AC power source (mains) as long as it is connected to the wall outlet, even if the unit itself has been turned off.
- Unplug the unit from the wall outlet if you do not intend to use it for an extended period of time. To disconnect the cord, pull it out by the plug, never by the cord.
- (SLV-662HF/679HF) One blade of the plug is wider than the other for the purpose of safety and will fit into the power outlet only one way. If you are unable to insert the plug fully into the outlet, contact your Sony dealer.

Installing

- Allow adequate air circulation to prevent internal heat buildup.
- Do not place the unit on surfaces (rugs, blankets, etc.) or near materials (curtains, draperies) that may block the ventilation slots.
- Do not install the unit near heat sources such as radiators or air ducts, or in a place subject to direct sunlight, excessive dust, mechanical vibration or shock.
- Do not install the unit in an inclined position. It is designed to be operated in a horizontal position only.
- Keep the unit and cassettes away from equipment with strong magnets, such as microwave ovens or large loudspeakers.
- Do not place heavy objects on the unit.
- If the unit is brought directly from a cold to a warm location, moisture may condense inside the VCR and cause damage to the video head and tape. When you first install the unit, or when you move it from a cold to a warm location, wait for about three hours before operating the unit.

Information

For customers in the USA

CAUTION

You are cautioned that any changes or modifications not expressly approved in this manual could void your authority to operate this equipment.

NOTE:

This equipment has been tested and found to comply with the limits for a Class B digital device, pursuant to Part 15 of the FCC Rules. These limits are designed to provide reasonable protection against harmful interference in a residential installation. This equipment generates, uses, and can radiate radio frequency energy and, if not installed and used in accordance with the instructions, may cause harmful interference to radio communications. However, there is no guarantee that interference will not occur in a particular installation. If this equipment does cause harmful interference to radio or television reception, which can be determined by turning the equipment off and on, the user is encouraged to try to correct the interference by one or more of the following measures:

- Reorient or relocate the receiving antenna.
- Increase the separation between the equipment and receiver.
- Connect the equipment into an outlet on a circuit different from that to which the receiver is connected.
- Consult the dealer or an experienced radio/TV technician for help.

Caution

Television programs, films, video tapes and other materials may be copyrighted. Unauthorized recording of such material may be contrary to the provisions of the copyright laws. Also, use of this recorder with cable television transmission may require authorization from the cable television transmission and/or program owner.

Table of contents

Getting Started

- 4 Step 1: Unpacking
- 5 Step 2: Setting up the remote commander
- 7 Step 3: Hookups
- 25 Selecting a language
- 26 Setting the clock
- 34 Presetting channels
- 40 Setting up the VCR Plus+* system

Basic Operations

- 44 Playing a tape
- 47 Recording TV programs
- 50 Recording TV programs using the VCR Plus+ system
- 53 Setting the timer manually

Additional Operations

- 56 Playing/searching at various speeds
- 58 Setting the recording duration time
- 59 Checking/changing/canceling timer settings
- 61 Recording stereo and bilingual programs
- 63 Adjusting the picture
- 64 Changing menu options
- 66 Editing with another VCR

Additional Information

- 68 General setup information
- 70 Troubleshooting
- 72 Specifications
- 73 Index to parts and controls
- 78 Index
- back cover**
Quick reference to using the VCR

* VCR Plus+ and PlusCode are registered trademarks of Gemstar Development Corporation. The VCR Plus+ system is manufactured under license from Gemstar Development Corporation.

Step 1

Unpacking

Check that you have received the following items with the VCR:

- Remote commander

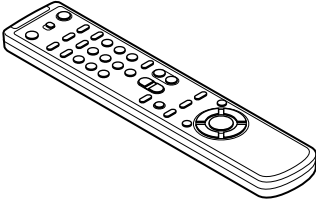

- 75-ohm coaxial cable with F-type connectors

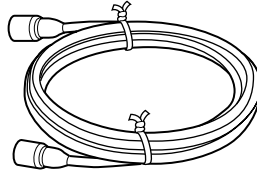

- Size AA (R6) batteries

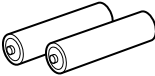

- Plug adaptor (SLV-679HF PX only)

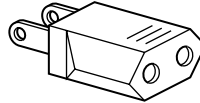

- Audio/video cable (3-phono to 3-phono)

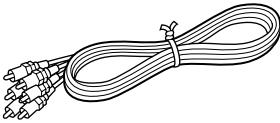

If the plug supplied with your VCR does not fit your power outlet, attach the supplied adaptor to the plug.

Checking your model name

The instructions in this manual are for the 3 models: SLV-662HF, 679HF and 679HF PX. Check your model number by looking at the rear panel of your VCR. The SLV-662HF is the model used for illustration purposes. Any difference in operation is clearly indicated in the text, for example, "SLV-679HF only."

Step 2

Setting up the remote commander

Inserting the batteries

Insert two size AA (R6) batteries by matching the + and - on the batteries to the diagram inside the battery compartment.

Insert the negative (-) end first, then push in and down until the positive (+) end clicks into position.

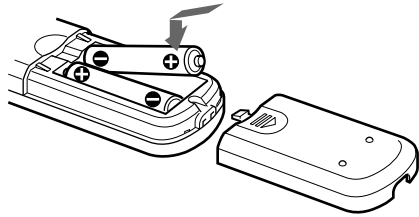

Using the remote commander

You can use this remote commander to operate this VCR and a Sony TV. Buttons on the remote commander marked with a dot (•) can be used to operate your Sony TV.

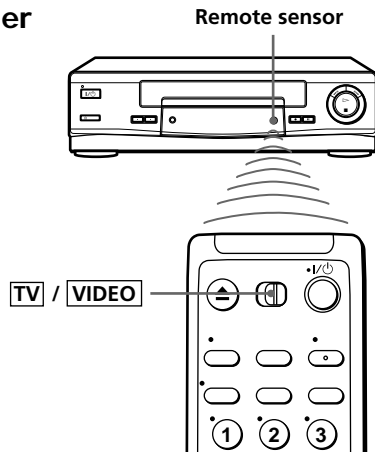

To operate	Set TV / VIDEO to
the VCR	VIDEO and point at the remote sensor on the VCR
a Sony TV	TV and point at the remote sensor on the TV

Notes

- With normal use, the batteries should last about three to six months.
- If you do not use the remote commander for an extended period of time, remove the batteries to avoid possible damage from battery leakage.
- Do not use a new battery with an old one.
- Do not use different types of batteries.

continued

Step 2: Setting up the remote commander (continued)

Controlling other TVs with the remote commander

The remote commander is preprogrammed to control non-Sony TVs. If your TV is listed in the table below, set the appropriate manufacturer's code number.

- 1 Set **TV**/**VIDEO** at the top of the remote commander to **TV**.
- 2 Hold down **I/⏻**, and enter your TV's code number(s) using the number buttons. Then release **I/⏻**.

Now you can use the **I/⏻**, **VOL +/-**, **CH +/-** and **TV/VIDEO** buttons to control your TV. You can also use the buttons marked with a dot (•) to control a Sony TV. To control the VCR, reset **TV**/**VIDEO** to **VIDEO**.

Code numbers of controllable TVs

If more than one code number is listed, try entering them one at a time until you find the one that works with your TV.

Manufacturer	Code number	Manufacturer	Code number	Manufacturer	Code number
Sony	01	JVC	09	RCA	04, 10
Akai	04	KMC	03	Sampo	12
AOC	04	Magnavox	03, 08, 12	Sanyo	11
Centurion	12	Marantz	04, 13	Scott	12
Coronado	03	MGA/Mitsubishi	04, 12, 13, 17	Sears	07, 10, 11
Curis-Mathes	12	NEC	04, 12	Sharp	03, 05, 18
Daytron	12	Panasonic	06, 19	Sylvania	08, 12
Emerson	03, 04, 14	Philco	03, 04	Teknika	03, 08, 14
Fisher	11	Philips	08	Toshiba	07
General Electric	06, 10	Pioneer	16	Wards	03, 04, 12
Gold Star	03, 04, 17	Portland	03	Yorx	12
Hitachi	02, 03	Quasar	06, 18	Zenith	15
J.C.Penny	04, 12	Radio Shack	05, 14		

Notes

- If the TV uses a different remote control system from the one programmed to work with the VCR, you cannot control your TV with the remote commander.
- If you enter a new code number, the code number previously entered will be erased.
- When you replace the batteries of the remote commander, the code number may change. Set the appropriate code number every time you replace the batteries.

Step 3

Hookups

Selecting the best hookup option

There are many ways in which your VCR can be hooked up. To hook up your VCR so that it works best for you, first scan through the table below. Then use the accompanying diagrams and procedures on the following pages to set up your VCR.

If you have	Use	Refer to
TV that has audio/video input	Audio/video (A/V) hookup , then follow one of the hookups below.	Pages 8 and 9
Antenna only, no cable TV	Hookup 1	Pages 10 to 12
Cable box with many scrambled channels	Hookup 2	Pages 13 to 16
No cable box or cable box with only a few scrambled channels	Hookup 3	Pages 17 to 19
Cable box with only a few scrambled channels, using an A/B switch	Hookup 4	Pages 20 to 24

After you've completed the connections, follow the instructions for setup. During setup, if you need more details on the procedure described, page numbers are provided where you can find complete, step-by-step instructions.

After you've completed the setup, you're ready to use your VCR. Procedures differ depending on the hookup you used. For an overview, refer to "Quick reference to using the VCR" on the back cover.

Before you get started

- Turn off the power to all equipment.
- Do not connect the AC power cords until all of the connections are completed.
- Be sure you make connections firmly. Loose connections may cause picture distortion.
- If your TV doesn't match any of the examples provided, see your nearest Sony dealer or qualified technician.

continued

Step 3: Hookups (continued)

Audio/video (A/V) hookup

Pages 8 and 9

If your TV has audio/video (A/V) input jacks, you will get a better picture and sound if you hook up your VCR using these connections. In addition, for a true “home theater” experience, you should connect the audio outputs of your VCR or TV to your stereo system. If your TV doesn’t have A/V inputs, see the following pages for antenna or cable hookups.

If you’re not planning to use your VCR to record programs, you’re finished setting up the VCR after you’ve made the connections shown on this page. If you want to record off-air or off your cable TV system, complete these connections first, and then go to the following pages for antenna or cable hookups.

A Use this hookup if your TV has stereo jacks

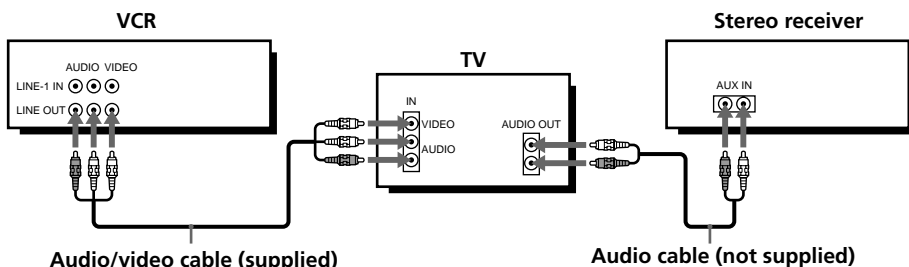

B Use this hookup if your TV doesn't have stereo jacks

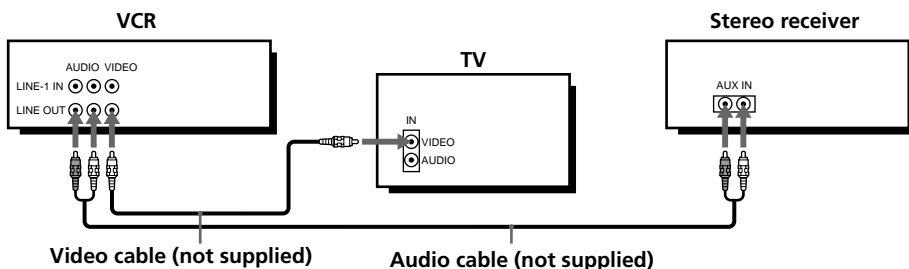

Note

- To play a tape in stereo, you must use the A/V connection.

A/V hookup: VCR setup

After you've connected your TV and completed antenna or cable hookup, use the following procedure to set up the VCR.

Press **MENU** and select **ADVANCED OPTIONS**.

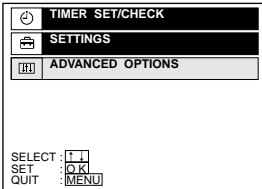

Set **AUTO ANT SELECT** to **OFF** and press **OK**.

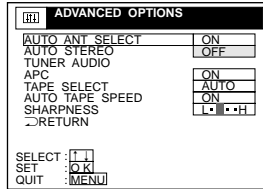

For details, see page 64.

Caution

Connections between the VCR's VHF/UHF connector and the antenna terminals of the TV receiver should be made only as shown in the following instructions. Failure to do so may result in operation that violates the regulations of the Federal Communications Commission regarding the use and operation of RF devices. Never connect the output of the VCR to an antenna or make simultaneous (parallel) antenna and VCR connections at the antenna terminals of your receiver.

Note to CATV system installer (in USA)

This reminder is provided to call the CATV system installer's attention to Article 820-40 of the NEC that provides guidelines for proper grounding and, in particular, specifies that the cable ground shall be connected to the grounding system of the building, as close to the point of cable entry as practical.

continued

Antenna hookup

Make the following connections if you're using an antenna (if you don't have cable TV).

A Use this hookup if you're using:

- VHF/UHF antenna (you get channels 2–13 and channels 14 and higher)
- UHF-only antenna (you get channels 14 and higher)
- Separate VHF and UHF antennas

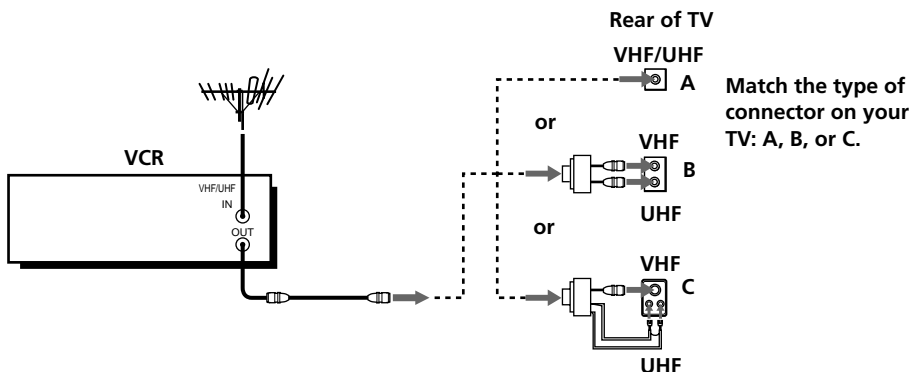

B Use this hookup if you're using a VHF-only antenna (you get channels 2–13 only)

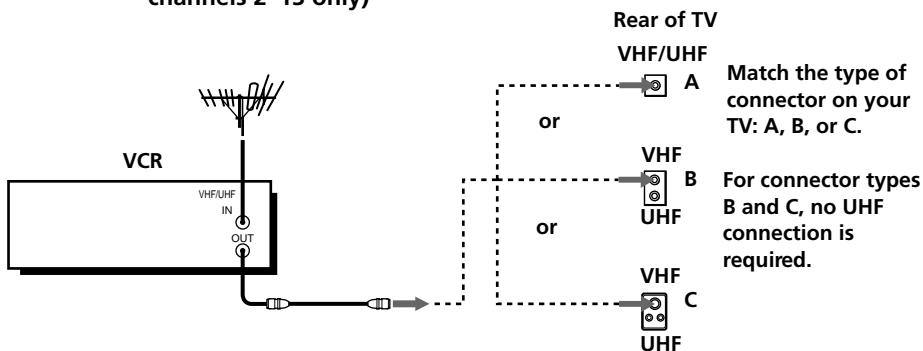

If you cannot connect your antenna cable to the VCR directly

If your antenna cable is a flat cable (300-ohm twin lead cable), attach an external antenna connector (not supplied) so you can connect the cable to the VHF/UHF IN connector. If you have separate cables for VHF and UHF antennas, you should use a U/V band mixer (not supplied). For details, see page 69.

Hookup 1: VCR setup

- 1 Set the RF UNIT switch to CH3 or CH4, whichever channel is not used in your area. If both are used, set the switch to either channel. For details, see page 68. If you made A/V connections (page 8), you can skip this step.

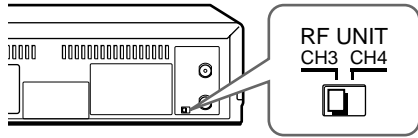

- 2 Press EASY SET UP on the VCR.

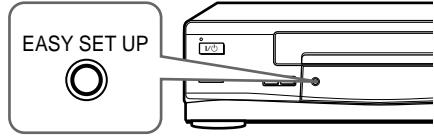

- 1 The LANGUAGE menu appears. Change the on-screen display language to Spanish (ESPAÑOL) or French (FRANÇAIS) if desired, and press OK. For details, see page 25.

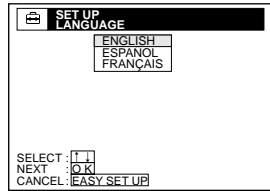

- 2 The CLOCK SET menu appears.
 - When the date setting menu appears, set the date and time, then press OK. For details, see page 27.
 - When the AUTO/MANUAL selection menu appears, select AUTO and press OK. For details, see page 30.

- 3 The TUNER PRESET menu appears. Set ANTENNA/CABLE to ANT and press OK. For details, see page 35.

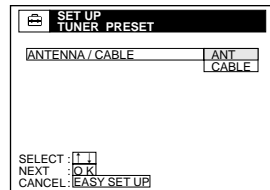

- 4 The AUTO PRESET starts.

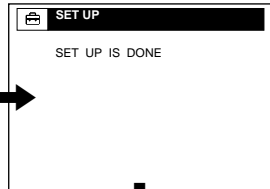
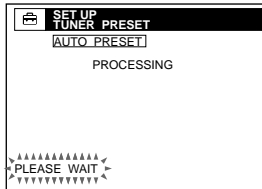

Normal display

continued

Step 3: Hookups (continued)

Hookup 1: The VCR Plus+ system channel setup

- 1 Find the VCR Plus+ system Channel Listing in your program guide. For details, see page 40.
- 2 If the channels in the program guide are different from the channels that you actually use on your TV, set the channels that are different as follows. For details, see page 41.

- 1 Press MENU, then select SETTINGS and press OK.

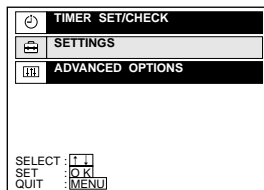

- 2 Select SET VCR Plus+ CHANNELS and press OK.

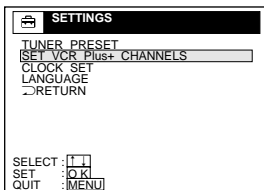

- 3 Enter the program guide channel, then the channel you use on your TV.

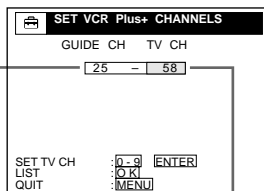

Program guide channel
Your actual TV channel

- 4 Press OK.
- 5 Press MENU to exit the menu.

Automatic clock setting (SLV-679HF/679HF PX only)

Once you've set up the VCR, it automatically sets the clock the first time you turn off the VCR. After that, whenever you turn off the VCR, it checks the time and adjusts the clock, even for Daylight Saving Time. The VCR sets the clock by picking up a time signal provided by some TV channels.

If you want to use the timer to record right away, or if the channels in your area do not carry time signals, set the clock manually. For details, see page 26.

Cable box with many scrambled channels

Recommended use

Use this hookup if your cable system scrambles all or most channels.

What you can do with this hookup

- Record any channel by selecting the channel on the cable box

What you can't do

- Record with the cable box turned off
- Record one channel while watching another channel

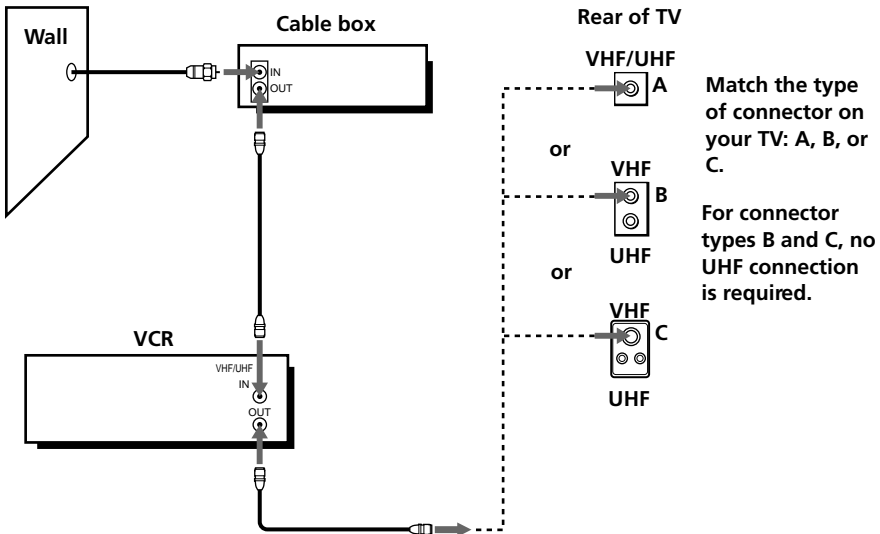

continued

Step 3: Hookups (continued)

Hookup 2: VCR setup

- 1 Set the RF UNIT switch to CH3 or CH4, whichever channel is not used in your area. If both are used, set the switch to either channel. For details, see page 68. If you made A/V connections (page 8), you can skip this step.

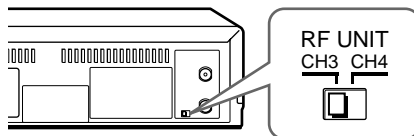

- 2 Turn on your cable box.
- 3 Press EASY SET UP on the VCR.

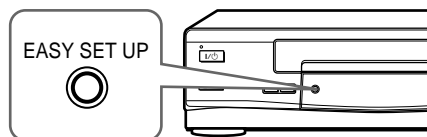

- 1 The LANGUAGE menu appears. Change the on-screen display language to Spanish (ESPAÑOL) or French (FRANÇAIS) if desired, and press OK. For details, see page 25.

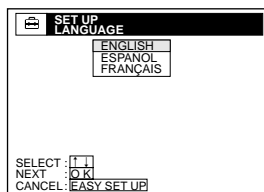

- 2 The CLOCK SET menu appears.
 - When the date setting menu appears, set the date and time, then press OK. For details, see page 27.
 - When the AUTO/MANUAL selection menu appears, select MANUAL and press OK. Then set the clock manually and press OK. For details, see page 27.

- 3 The TUNER PRESET menu appears. Set ANTENNA/CABLE to ANT and press OK. For details, see page 35.

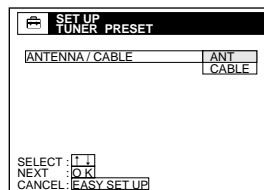

- 4 The AUTO PRESET starts.

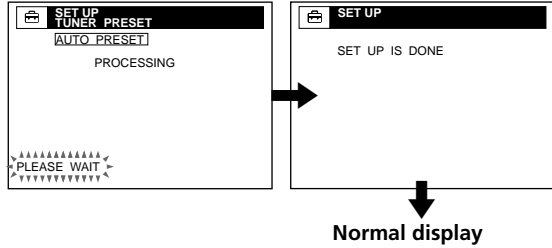

Hookup 2: The VCR Plus+ system channel setup

- 1 Find the VCR Plus+ system Channel Listing in your program guide. For details, see page 40.
- 2 Enter all the channels you want to record and the cable box output channel (usually 2, 3, or 4). For details, see page 41.

- 1 Press MENU, then select SETTINGS and press OK.

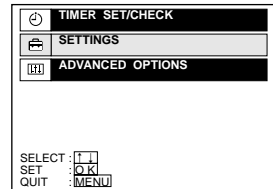

- 2 Select SET VCR Plus+ CHANNELS and press OK.

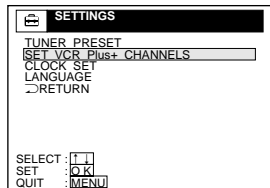

- 3 Enter the program guide channel, then the cable box output channel.

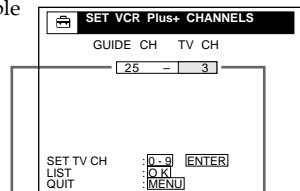

Program guide channel

Cable box output channel

- 4 Press OK.
- 5 Press MENU to exit the menu.

continued

Step 3: Hookups (continued)

Automatic clock setting (SLV-679HF/679HF PX only)

To use the Auto Clock Set feature with this hookup, you need to manually select a channel that carries a time signal:

- 1** Tune the cable box to a channel that carries a time signal.
- 2** Select **AUTO** in the **CLOCK SET** menu to turn on the Auto Clock Set feature.
- 3** Turn off the **VCR**. It automatically sets the clock and adjusts for Daylight Saving Time by picking up the time signal.

If you want to use the timer to record right away, or if the channels in your area do not carry time signals, set the clock manually. For details, see page 26.

Note

- To use the Auto Clock Set feature, leave the cable box on.

No cable box, or cable box with only a few scrambled channels

Recommended use

Use this hookup if you do not have a cable box. Also use this hookup if your cable system scrambles only a few channels.

What you can do with this hookup

- Record any unscrambled channel by selecting the channel on the VCR

What you can't do

- Record scrambled channels that require a cable box

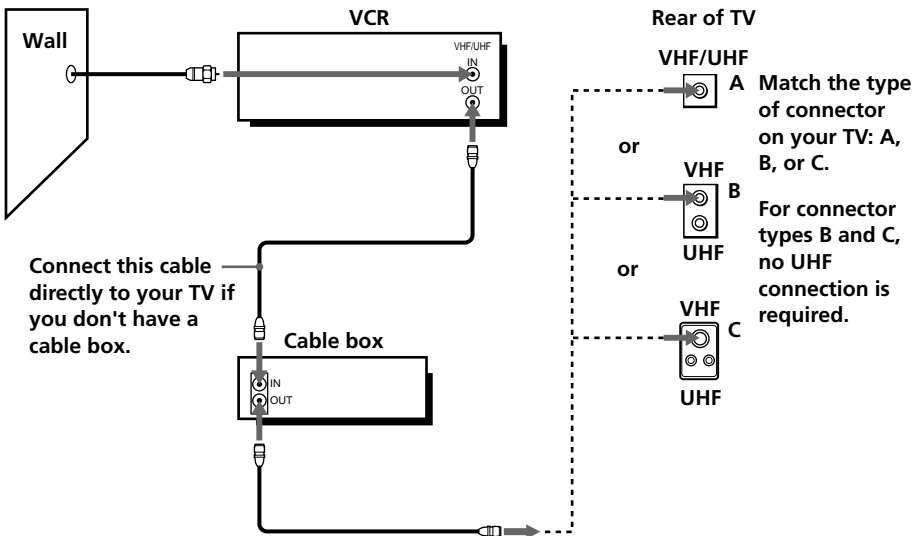

continued

Step 3: Hookups (continued)

Hookup 3: VCR setup

- 1 Set the RF UNIT switch to CH3 or CH4, whichever channel is not used in your area. If both are used, set the switch to either channel. For details, see page 68. If you made A/V connections (page 8), you can skip this step.

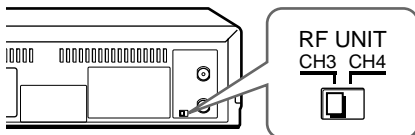

- 2 Turn on your cable box.
- 3 Press EASY SET UP on the VCR.

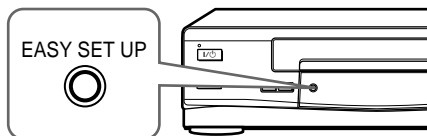

- 1 The LANGUAGE menu appears. Change the on-screen display language to Spanish (ESPAÑOL) or French (FRANÇAIS) if desired, and press OK. For details, see page 25.

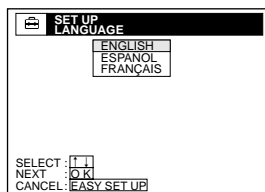

- 2 The CLOCK SET menu appears.
 - When the date setting menu appears, set the date and time, then press OK. For details, see page 27.
 - When the AUTO/MANUAL selection menu appears, select AUTO and press OK. For details, see page 30.

- 3 The TUNER PRESET menu appears. Set ANTENNA/CABLE to CABLE and press OK. For details, see page 35.

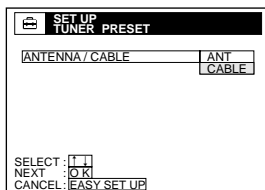

- 4 The AUTO PRESET starts.

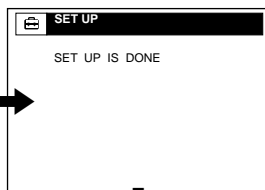
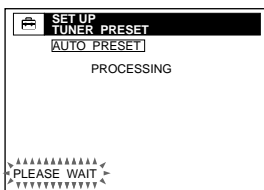

Normal display

Hookup 3: The VCR Plus+ system channel setup

- 1 Find the VCR Plus+ system Channel Listing in your program guide. For details, see page 40.
- 2 If the channels in the program guide are different from the channels that you actually use on your TV, set the channels that are different as follows. For details, see page 41.

- 1 Press MENU, then select SETTINGS and press OK.

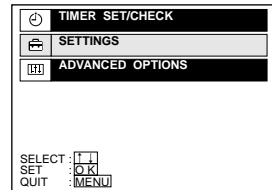

- 2 Select SET VCR Plus+ CHANNELS and press OK.

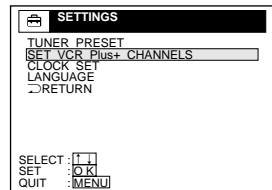

- 3 Enter the program guide channel, then the channel you use on your TV.

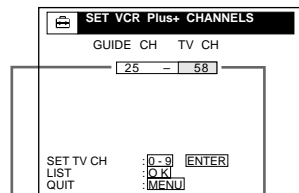

Program guide channel
Your actual TV channel

- 4 Press OK.
- 5 Press MENU to exit the menu.

Automatic clock setting (SLV-679HF/679HF PX only)

Once you've set up the VCR, it automatically sets the clock the first time you turn off the VCR. After that, whenever you turn off the VCR, it checks the time and adjusts the clock, even for Daylight Saving Time. The VCR sets the clock by picking up a time signal provided by some TV channels.

If you want to use the timer to record right away, or if the channels in your area do not carry time signals, set the clock manually. For details, see page 26.

continued

Cable box with only a few scrambled channels, using an A/B switch

Recommended use

By using an A/B switch (not supplied), this hookup allows you to record both scrambled and unscrambled channels conveniently.

What you can do with this hookup

- Record any unscrambled channel by selecting the channel directly on the VCR (the A/B switch is set to A)
- Record any scrambled channel by selecting the channel on the cable box (the A/B switch is set to B)

What you can't do

- Record one scrambled channel while watching another channel (the A/B switch is set to B)

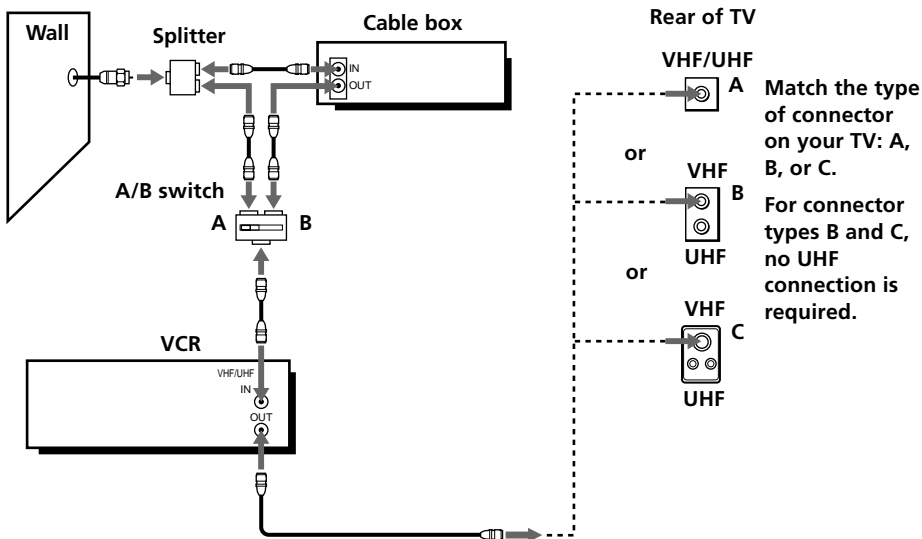

Hookup 4: VCR setup

- 1 Set the RF UNIT switch to CH3 or CH4, whichever channel is not used in your area. If both are used, set the switch to either channel. For details, see page 68. If you made A/V connections (page 8), you can skip this step.

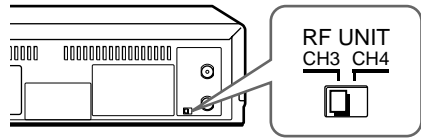

- 2 Set the A/B switch to "A."
- 3 Press EASY SET UP on the VCR.

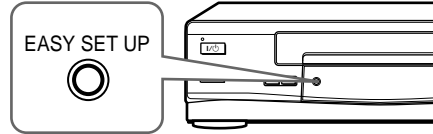

- 1 The LANGUAGE menu appears. Change the on-screen display language to Spanish (ESPAÑOL) or French (FRANÇAIS) if desired, and press OK. For details, see page 25.

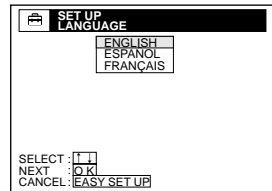

- 2 The CLOCK SET menu appears.
 - When the date setting menu appears, set the date and time, then press OK. For details, see page 27.
 - When the AUTO/MANUAL selection menu appears, select AUTO and press OK. For details, see page 30.

- 3 The TUNER PRESET menu appears. Set ANTENNA/CABLE to CABLE and press OK. For details, see page 35.

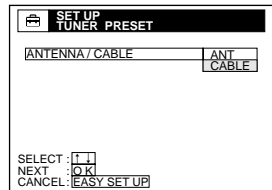

continued

Step 3: Hookups (continued)

- 4 The AUTO PRESET starts.

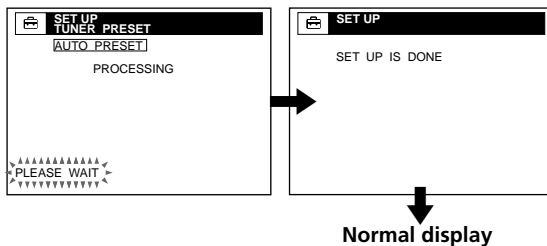

- 4 Preset the cable box output channel (usually 2, 3 or 4). For details, see page 36.

- 1 Press MENU, then select SETTINGS and press OK.
- 2 Select TUNER PRESET and press OK.

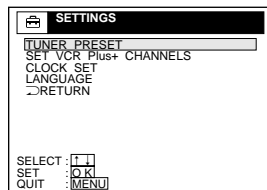

- 3 Enter the cable box output channel.
- 4 Set MANUAL SET to ADD and press OK.

Cable box output channel

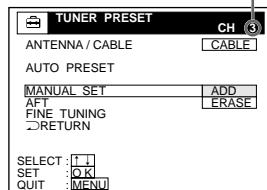

- 5 Press MENU to exit the menu.

Hookup 4: The VCR Plus+ system channel setup

- 1 Find the VCR Plus+ system Channel Listing in your program guide. For details, see page 40.
- 2 To set the program guide channels for unscrambled channels, if the channels in the program guide are different from the channels that you actually use on your TV, set the channels that are different as follows. For details, see page 41.

- 1 Press MENU, then select SETTINGS and press OK.

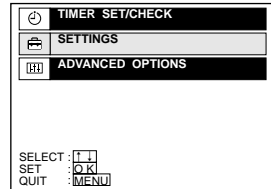

- 2 Select SET VCR Plus+ CHANNELS and press OK.

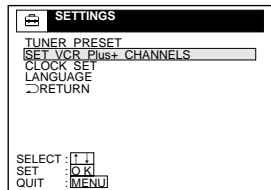

- 3 Enter the program guide channel, then the channel you use on your TV.

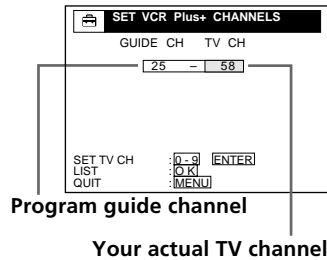

- 4 Press OK.
- 5 Press MENU to exit the menu.

continued

Step 3: Hookups (continued)

3 To set the program guide channels for scrambled channels, enter all the scrambled channels you want to record and the cable box output channel (usually 2, 3, or 4). For details, see page 41.

- 1** Press MENU, then select SETTINGS and press OK.

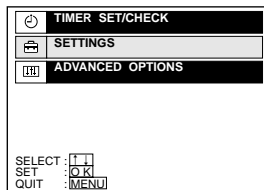

- 2** Select SET VCR Plus+ CHANNELS and press OK.

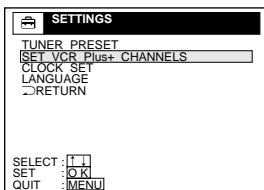

- 3** Enter the program guide channel, then the cable box output channel.

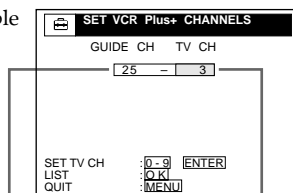

Program guide channel

Cable box output channel

- 4** Press OK.
- 5** Press MENU to exit the menu.

Automatic clock setting (SLV-679HF/679HF PX only)

Once you've set up the VCR, it automatically sets the clock the first time you turn off the VCR. After that, whenever you turn off the VCR, it checks the time and adjusts the clock, even for Daylight Saving Time. The VCR sets the clock by picking up a time signal provided by some TV channels.

If you want to use the timer to record right away, or if the channels in your area do not carry time signals, set the clock manually. For details, see page 26.

Note

- To use the Auto Clock Set feature, set the A/B switch to "A."

Selecting a language

You can change the on-screen display language.

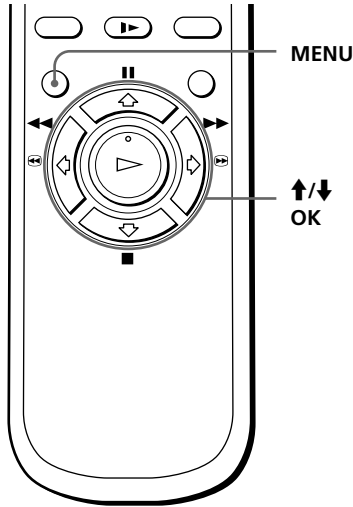

1

MENU



Press MENU, then press ↑/↓ to highlight SETTINGS and press OK.

When using the EASY SET UP procedure, skip steps 1 and 2.

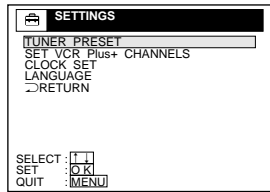

2



Press ↑/↓ to highlight LANGUAGE, then press OK.

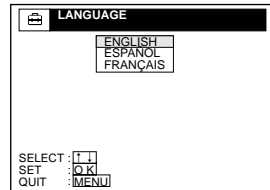

3



Press ↑/↓ to highlight ENGLISH, ESPAÑOL, or FRANÇAIS, then press OK.

4

MENU



Press MENU to exit the menu.

Tip

- If you want to return to the previous menu, highlight RETURN and press OK.

Setting the clock

Set the time and date to use the timer feature for recording programs.

SLV-679HF/679HF PX only

You can set the clock automatically (page 29).

Using Manual Clock Set

Set the time and date manually.

Before you start...

- Turn on the VCR and the TV.
- Set the TV to the VCR channel (channel 3 or 4). If your TV is connected to the VCR using A/V connections, set the TV to video input.
- Press TV/VIDEO to display the VIDEO indicator in the VCR's display window.

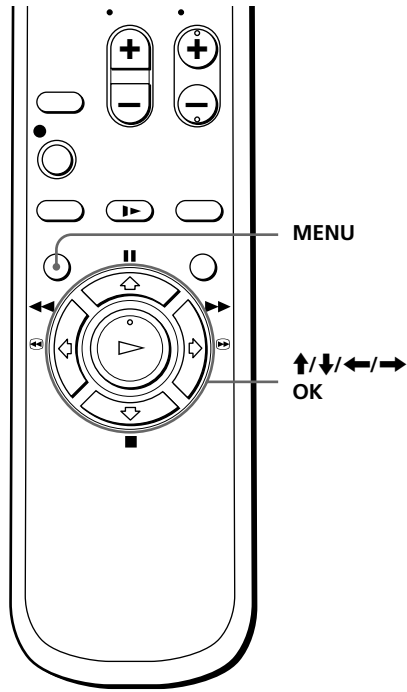

1

MENU



Press MENU, then press **↑/↓** to highlight SETTINGS and press OK.

When using the EASY SET UP procedure, skip steps 1 and 2.

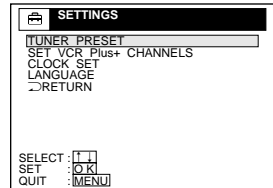

2



Press **↑/↓** to highlight CLOCK SET, then press OK.

3

SLV-662HF:

The date setting menu appears. Go to step 4.

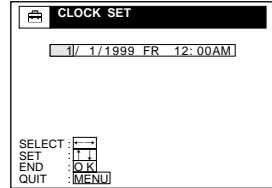

SLV-679HF/679HF PX:

The AUTO/MANUAL selection menu appears. Press **↑/↓** to highlight MANUAL, then press OK.

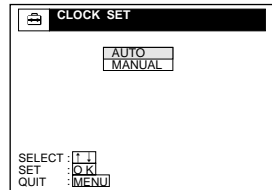

4



Press **↑/↓** to set the month.

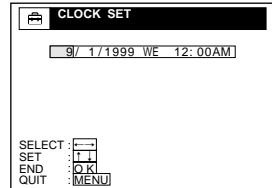

5



Press **→** to highlight the day and press **↑/↓** to set the day.

The day of the week is set automatically.

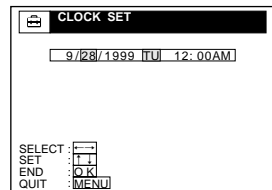

continued

Setting the clock (continued)

6

Set the year, hour, and minutes in the same way as the day.

7



Press OK to start the clock.

Tip

- If you want to return to the previous menu, highlight RETURN and press OK.

Using the Auto Clock Set feature (SLV-679HF/679HF PX only)

Some TV and cable channels transmit time signals with their broadcasts. Your VCR can pick up this time signal to automatically set the clock.

The Auto Clock Set feature works only if a channel in your area is broadcasting a time signal. If broadcasters in your area are not yet sending time signals, set the time manually (page 26).

Before you start...

- Turn on the VCR and the TV.
- Set the TV to the VCR channel (channel 3 or 4). If your TV is connected to the VCR using A/V connections, set the TV to video input.
- Press TV/VIDEO to display the VIDEO indicator in the VCR's display window.
- Press INPUT SELECT so that a channel number appears in the VCR's display window.

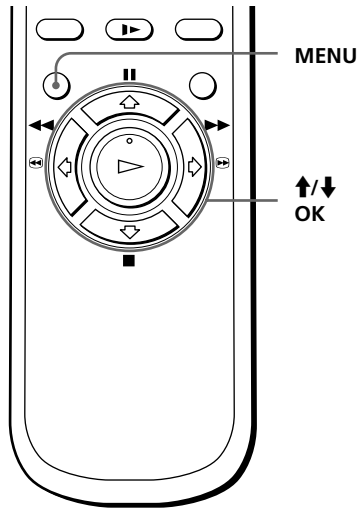

1

MENU



Press MENU, then press **↑/↓** to highlight SETTINGS and press OK.



When using the EASY SET UP procedure, skip steps 1 and 2.

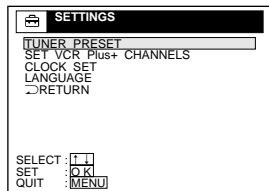

2



Press **↑/↓** to highlight CLOCK SET, then press OK.

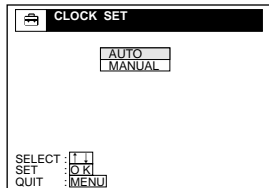

continued

Setting the clock (continued)

3



Press **↑/↓** to highlight AUTO, then press OK.

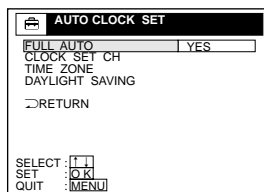

4



Press **↑/↓** to highlight FULL AUTO, then press OK.

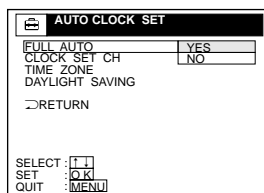

5



Press **↑/↓** to highlight YES, then press OK.

6



Press MENU to exit the menu.

7

To activate the Auto Clock Set function, turn off the VCR.

The VCR automatically sets the clock by searching for a channel that carries a time signal and sets your time zone and Daylight Saving Time (if applicable).

If your clock is set to the wrong time zone or Daylight Saving Time, you can adjust these settings without turning off the Auto Clock Set feature (page 31).

Tip

- If you want to return to the previous menu, highlight RETURN and press OK.

Notes

- The clock cannot be set automatically if you don't receive a channel that carries a time signal in your area. If so, set the clock manually.
- If there are only a few channels in your area that carry time signals, setting the clock automatically may take up to about 30 minutes. If nothing happens even after you wait about 30 minutes, set the clock manually.

If the clock is not activated (SLV-679HF/679HF PX only)

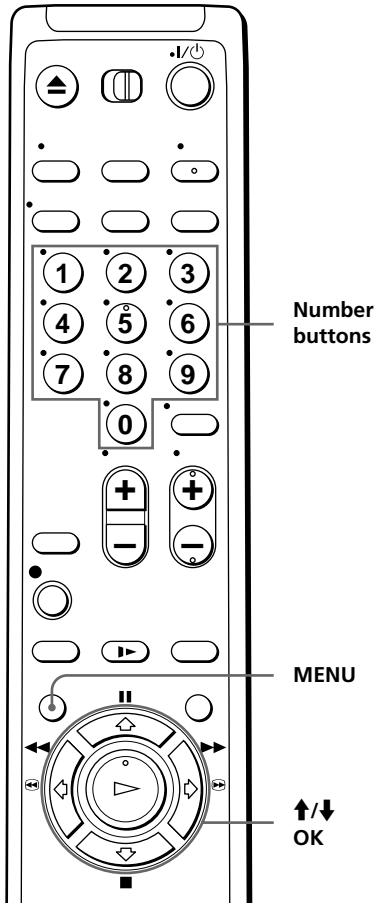

1

Follow steps 1 to 4 in "Using the Auto Clock Set feature."

The AUTO CLOCK SET menu is displayed.

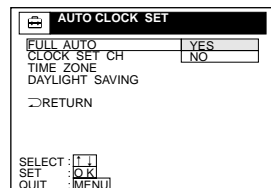

continued

Setting the clock (continued)

2



Press **↑/↓** to highlight NO for FULL AUTO and press OK.

AUTO CLOCK SET	
FULL AUTO	NO
CLOCK SET CH	---
TIME ZONE	AUTO
DAYLIGHT SAVING	AUTO
▷RETURN	
SELECT :	[↑]
SET :	[OK]
QUIT :	[MENU]

3



Press **↑/↓** to highlight the item you want to set and press OK. Then press **↑/↓** to make the setting and press OK.

- For CLOCK SET CH

Leave the setting to “---” to have the VCR automatically search for a channel that carries a time signal.

Press the number buttons to select a channel that carries a time signal.

Use this option if you know of a channel that carries a time signal. Most PBS member stations broadcast a time signal. For the fastest response, select your local PBS station.

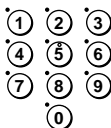

AUTO CLOCK SET	
FULL AUTO	NO
CLOCK SET CH	123
TIME ZONE	AUTO
DAYLIGHT SAVING	AUTO
▷RETURN	
USE :	[0-9]
SET :	[OK]
QUIT :	[MENU]

- For TIME ZONE

Select the time zone of your area, or select AUTO to have the VCR automatically set your time zone.

The options are:

AUTO ↔ ATLANTIC ↔
 EASTERN ↔ CENTRAL ↔
 MOUNTAIN ↔ PACIFIC ↔
 ALASKA ↔ HAWAII ↔ AUTO

AUTO CLOCK SET	
FULL AUTO	AUTO
CLOCK SET CH	---
TIME ZONE	ATLANTIC
DAYLIGHT SAVING	EASTERN
	CENTRAL
	MOUNTAIN
	PACIFIC
	ALASKA
	HAWAII
▷RETURN	
SELECT :	[↑]
SET :	[OK]
QUIT :	[MENU]

- For DAYLIGHT SAVING

Select ON or OFF (standard time), or AUTO to have the VCR automatically set the daylight saving time.

AUTO CLOCK SET	
FULL AUTO	NO
CLOCK SET CH	123
TIME ZONE	AUTO
DAYLIGHT SAVING	ON
	OFF
▷RETURN	
SELECT :	[↑]
SET :	[OK]
QUIT :	[MENU]

4

MENU



Press MENU to exit the menu.

5

To activate the Auto Clock Set function, turn off the VCR.

Tip

- If you want to return to the previous menu, highlight RETURN and press OK.

Presetting channels

This VCR is capable of receiving VHF channels 2 to 13, UHF channels 14 to 69 and unscrambled CATV channels 1 to 125. First, we recommend that you preset the receivable channels in your area using automatic presetting. Then, if there are any unwanted channels, disable them manually. If you have decided which channels you wish to preset, set them directly using manual presetting.

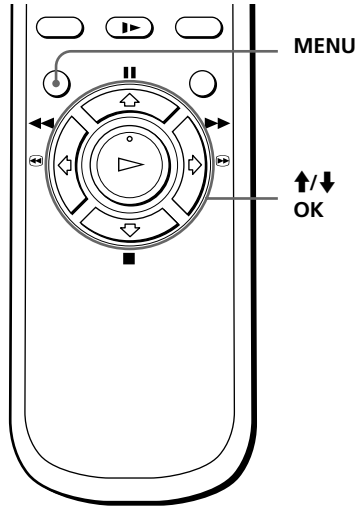

Before you start...

- Turn on the VCR and the TV.
- Set the TV to the VCR channel (channel 3 or 4). If your TV is connected to the VCR using A/V connections, set the TV to video input.
- Press TV/VIDEO to display the VIDEO indicator in the VCR's display window.

Presetting all receivable channels automatically

- 1** Press MENU, then press **↑/↓** to highlight SETTINGS and press OK.



When using the EASY SET UP procedure, skip steps 1 and 2.

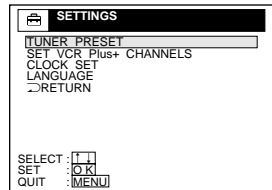

- 2** Press **↑/↓** to highlight TUNER PRESET, then press OK.

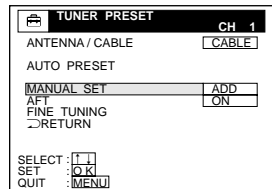

3



Press **↑/↓** to highlight ANTENNA/CABLE, then press OK.

4



• To preset cable TV channels:
Press **↑/↓** to set ANTENNA/CABLE to CABLE, then press OK.

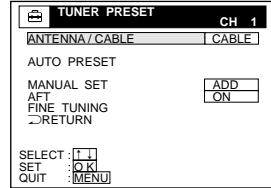

• To preset VHF and UHF channels:
Press **↑/↓** to set ANTENNA/CABLE to ANT, then press OK.

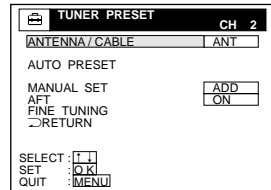

5



Press **↑/↓** to highlight AUTO PRESET, then press OK.

All receivable channels are preset in numerical sequence. When no more receivable channels can be found, presetting stops and the picture from the lowest numbered channel is displayed on the TV screen.

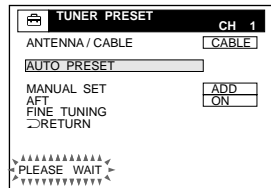

Tips

- When receiving a VHF, UHF, or CATV channel, the display changes as follows each time you press DISPLAY.

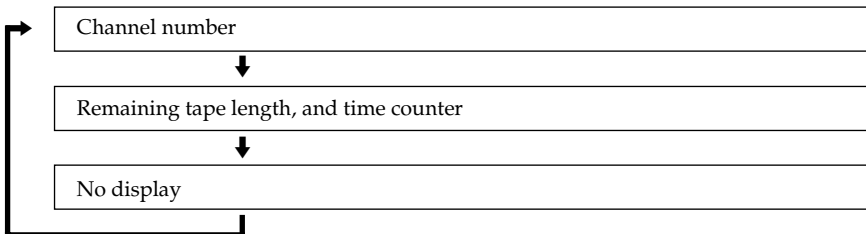

- If you want to return to the previous menu, highlight RETURN and press OK.

continued

Presetting channels (continued)

Presetting/disabling channels manually

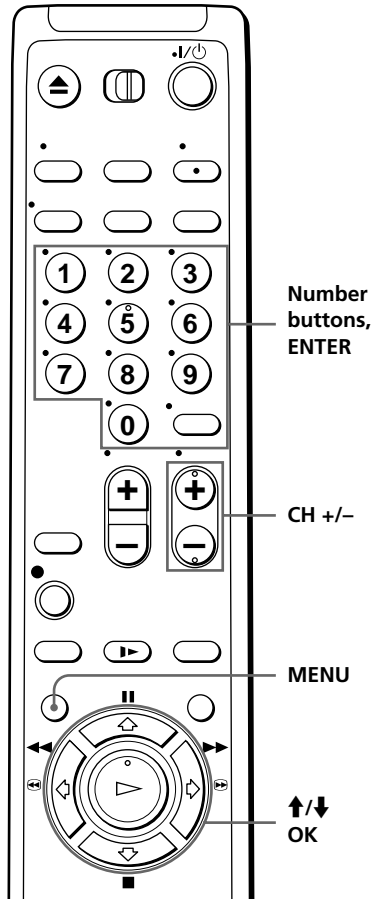

1

MENU



Press MENU, then press ↑/↓ to highlight SETTINGS and press OK.

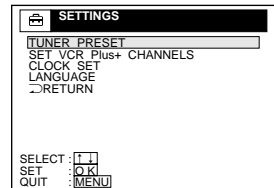

2



Press **↑/↓** to highlight TUNER PRESET, then press OK.

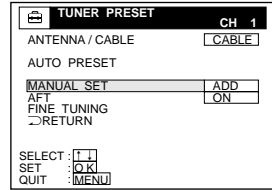

3

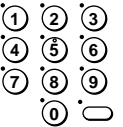

- To preset a channel:
 - 1 Press the number buttons to enter the channel number, then press ENTER.
 - 2 Press OK.
 - 3 Press **↑/↓** to set MANUAL SET to ADD, then press OK.

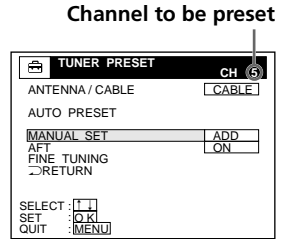

•CH



- To disable a channel:
 - 1 Press CH +/- to select the channel number.
 - 2 Press OK.
 - 3 Press **↑/↓** to set MANUAL SET to ERASE, then press OK.

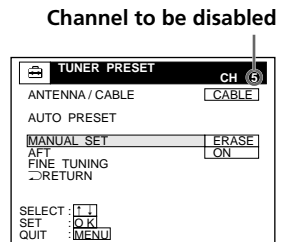

4



Repeat step 3 to preset or disable channels as required, then press MENU.

Tip

- If you want to return to the previous menu, highlight RETURN and press OK.

continued

Presetting channels (continued)

If the picture is not clear

Normally, the Auto Fine Tuning (AFT) function automatically tunes in channels clearly. If, however, the picture of a channel is not clear, you can also use the manual tuning function.

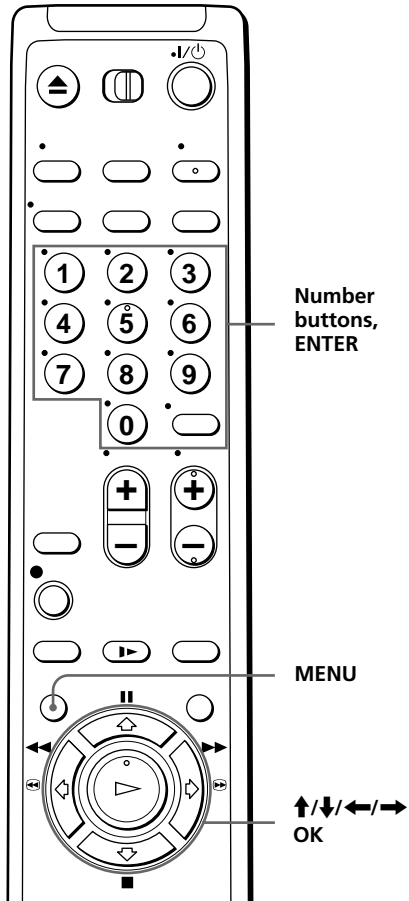

1 Press MENU, then press **↑/↓** to highlight SETTINGS and press OK.

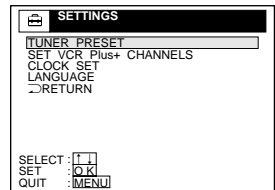

2



Press **↑/↓** to highlight TUNER PRESET, then press OK.

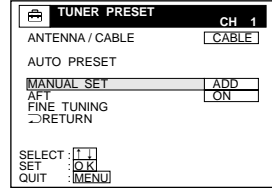

3



Press the number buttons to select the channel you want to fine-tune, then press ENTER.

Selected channel

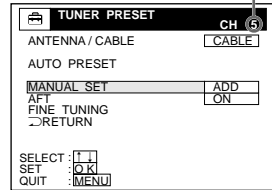

4



Press **↑/↓** to highlight FINE TUNING, then press OK.
The fine tuning meter appears.

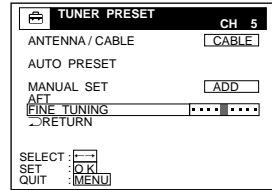

5



Press **←/→** to adjust to a clearer picture, then press OK.
Note that the AFT setting switches to OFF.

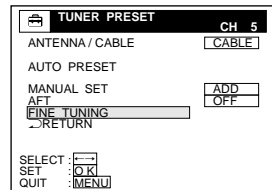

6



Press MENU to exit the menu.

Tips

- To select the channel in step 3 above, you can also use the CH +/- buttons. In this case, you don't need to press ENTER.
- If you want to return to the previous menu, highlight RETURN and press OK.

Note

- When adjusting FINE TUNING, the menu may become difficult to read due to interference from the picture being received.

Setting up the VCR Plus+ system

How the VCR Plus+ system works

Whenever you want to record a TV program, all you need to do is look up the "PlusCode" number, a number assigned to each program published in the TV section of most newspapers, cable TV listings, and even *TV GUIDE* magazine. Then, just enter the PlusCode number of the program you want and the VCR is automatically programmed to record that show. It's that simple.

Example of "PlusCode"

		PlusCode
5:30	14 MOVIE — Musical (2hrs.)	33044
	2 SPORT — Golf (1hr. 25min.)	42060
	CNN — WS 9974	
6:30	2 3 4 DRAMA — Comedy (2hrs.)	17390
	5 SCIENCE AND TECHNOLOGY (1hr. 15min.)	73457

How to set up your VCR

Setting up your VCR involves coordinating the TV channel number (the number you turn to on your TV or VCR to watch a program) with the guide channel (the number that's assigned to that channel in your program guide).

To find the guide channel numbers, look at the "Channel Line-up Chart" in the program guide for your area that features VCR PlusCodes. It usually looks like the example to the right.

To set the guide channels, use the Channel Line-up Chart to check that the guide channel numbers match the TV channel your VCR receives. For example, if HBO is listed in the Channel Line-up Chart on channel 33, and your VCR receives HBO on channel 5, you need to coordinate these numbers using the following procedure. If the guide and TV channel numbers are the same, you can skip this procedure.

Example of "Channel Line-up Chart"

CABLE CH	CABLE TV	VCR Plus+ GUIDE CH
16	AMC American Movie Classics	35
17	BRV Bravo (program grid only)	54
20	CNN Cable News Network	42
21	CSP C-SPAN	28
22	DIS The Disney Channel	53
25	DSC The Discovery Channel	37
34	ESN ESPN	34
35	FAM The Family Channel	47
5	HBO Home Box Office	33
27	LIF Lifetime	46
29	MAX Cinemax	45
30	MTV Music Television	48
31	NIK Nickelodeon	38
38	SC Sports Channel	59
39	SCA Sports Channel America	70
45	SHO Showtime	41
17	TBS TBS SuperStation	43
44	TMC The Movie Channel	58
49	TNN The Nashville Network	49
50	TNT Turner Network Television	52
51	USA USA Network	44

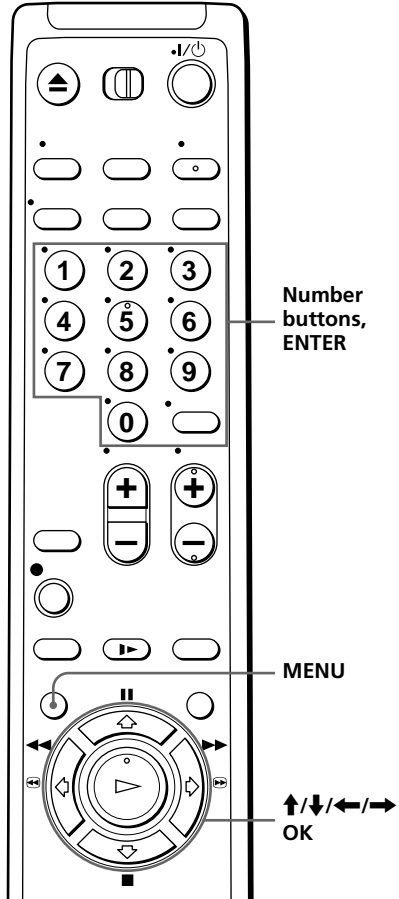

1

MENU



Press MENU, then press **↑/↓** to highlight SETTINGS and press OK.

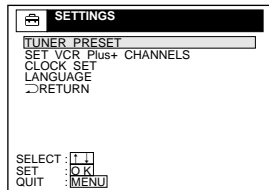

continued

Setting up the VCR Plus+ system (continued)

2



Press **↑/↓** to highlight SET VCR Plus+ CHANNELS, then press OK.

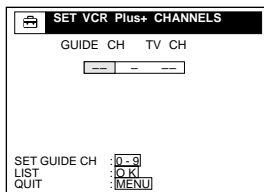

3

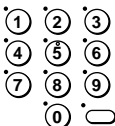

Enter the guide channel number assigned in the program guide and press ENTER.

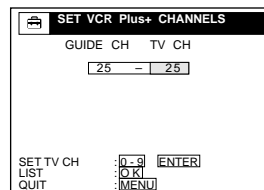

4

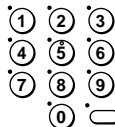

• If you made Hookup 1 or 3: Enter the actual number on your TV (and VCR) and press ENTER.

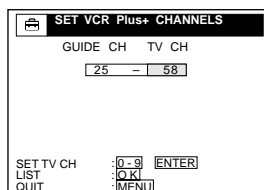

- If you made Hookup 2: Enter the cable box output channel (usually 2, 3 or 4) and press ENTER.
- If you made Hookup 4: Enter the actual number on your TV (and VCR) for an unscrambled channel and press ENTER. For a scrambled channel, enter the cable box output channel (usually 2, 3, or 4) and press ENTER.

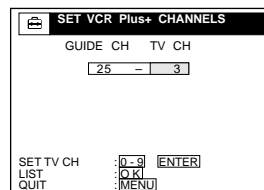

5

Repeat steps 3 and 4 for each channel number that does not match.

6



When you have set all channels, press OK to confirm your channel settings.

To return to the previous page, press ←.

To go to the next page, press →.

VCR Plus+ CHANNEL LIST PAGE1			
GUIDE	TV	GUIDE	TV
2 -	73	66 -	48
5 -	25	68 -	59
17 -	5	71 -	63
25 -	58	74 -	123
34 -	115	79 -	6
39 -	68	82 -	100
43 -	7	85 -	98
48 -	12	88 -	52
52 -	55	91 -	30
59 -	36	93 -	87

PAGE : []
QUIT : MENU

7

MENU



After all settings are complete, press MENU to exit the menu.

Tip

- If you want to return to the previous menu, highlight RETURN and press OK.

Playing a tape

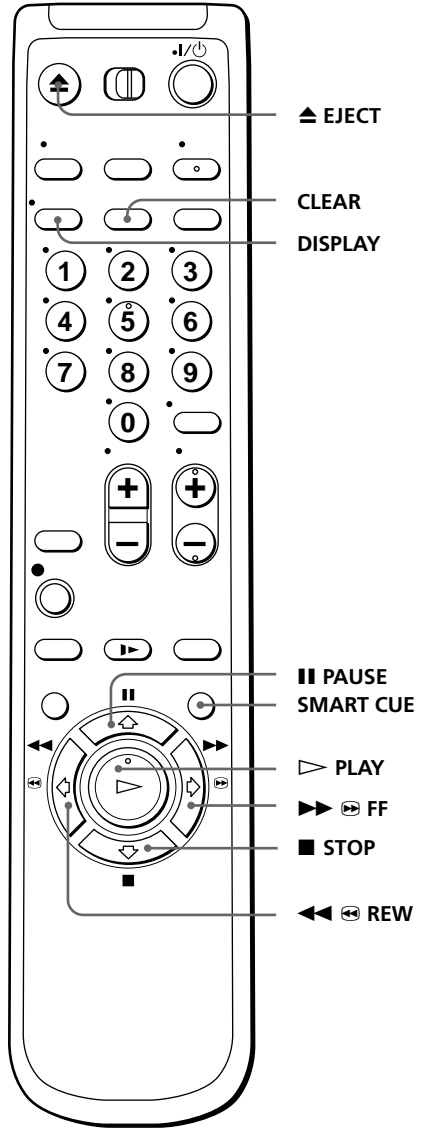

1

Turn on your TV and set it to the video channel.

2

Insert a tape.

The VCR turns on and starts playing automatically if you insert a tape with its safety tab removed.

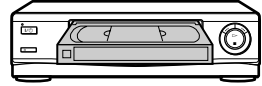







3



Press  PLAY.

When the tape reaches the end, it will rewind automatically.

Additional tasks

To	Press
Stop play	■ STOP
Pause play	PAUSE
Resume play after pause	PAUSE or  PLAY
Fast-forward the tape	  FF during stop
Rewind the tape	  REW during stop
Eject the tape	 EJECT

To skip playback

You can skip a portion of playback you don't want to watch such as a commercial and restart playback by pressing a single button.

- 1 Press SMART CUE during playback of the scene you want to skip. The VCR starts searching.
- 2 Press SMART CUE again when you find the scene you want to watch. The VCR stops searching, rewinds a few seconds, then resumes normal playback.

If you press and hold SMART CUE while the VCR is skip searching, the VCR will stop searching, and continue rewinding until you release SMART CUE.

continued

Playing a tape (continued)

To use the time counter

At the point on the tape that you want to find later, press CLEAR. The counter in the display window resets to "0:00:00." Search for the point afterwards by referring to the counter.



To display the counter on the TV screen, press DISPLAY.

Notes

- Tapes recorded in the LP mode on other VCRs can be played back on this VCR but the picture quality cannot be guaranteed.
- While setting the menu on the TV screen, you cannot use ▷ PLAY, || PAUSE, ►► ⏪ FF, ◀◀ ⏩ REW, or ■ STOP buttons.
- The counter resets to "0:00:00" whenever a tape is reinserted.
- The counter stops counting when it comes to a portion with no recording.

Recording TV programs

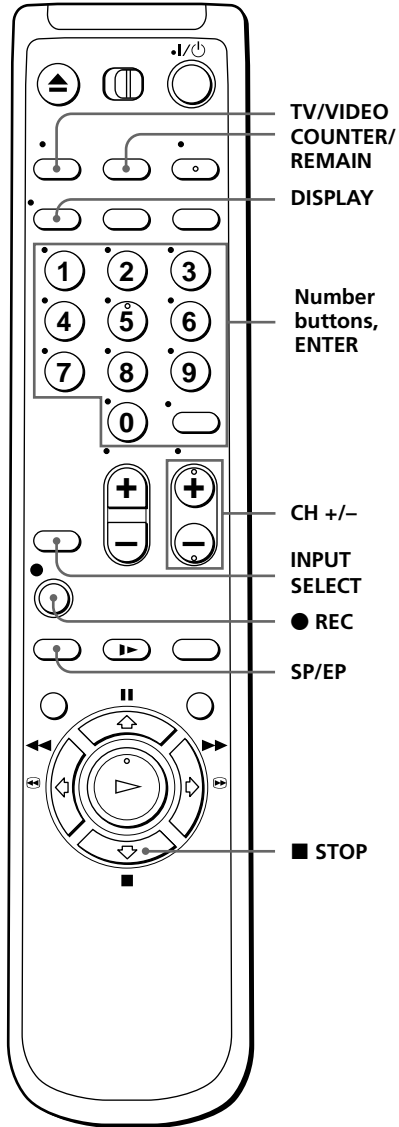

1 Turn on your TV and set it to the video channel.
To record from a cable box, turn it on.

2 Insert a tape with its safety tab in place.

continued

Recording TV programs (continued)

- 3**  Press INPUT SELECT until a channel number appears in the display window.



- 4**  Press CH +/- to select the channel you want to record.



- 5**  Press SP/EP to select the tape speed, SP or EP.
EP (Extended Play) provides recording time three times as long as SP (Standard Play), however, SP produces better picture and audio quality.



- 6**  Press ● REC to start recording.
The recording indicator lights up red in the display window.

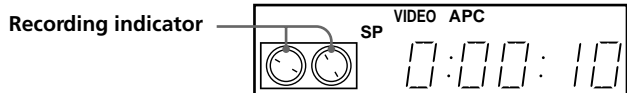

To stop recording

Press ■ STOP.

To check the remaining tape length

Press DISPLAY. The remaining tape length and the time counter appear on the TV screen. Each time you press COUNTER/REMAIN, the time counter and remaining tape length with the  indicator appear alternately in the display window.

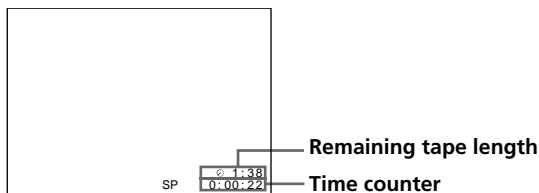

To check the remaining time of a T-140 or T-180 tape, set TAPE SELECT in the ADVANCED OPTIONS menu to 180. (For details, see page 65.)

To watch another TV program while recording

- 1 Press TV/VIDEO to turn off the VIDEO indicator in the display window.
- 2 If the TV is connected to the VCR's LINE OUT jacks, set the TV to TV input; if not, skip this step.
- 3 Select another channel on the TV.

To save a recording

To prevent accidental erasure, break off the safety tab as illustrated. To record on a tape again, cover the tab hole with adhesive tape.



Tips

- To select a channel, you can use the number buttons on the remote commander. Enter the channel number, then press ENTER.
- You can select a video source from the LINE-1 IN jacks using the INPUT SELECT button.
- The display appears on the TV screen indicating information about the tape, but the information won't be recorded on the tape.
- If you don't want to watch TV while recording, you can turn off the TV. When using a cable box, make sure to leave it on.

Notes

- The remaining tape length may not be indicated accurately for short tapes such as T-20 or T-30, or tapes recorded in the LP mode.
- The display does not appear during still (pause) mode or slow-motion playback.
- It may take up to one minute for the VCR to calculate and display the remaining tape length after you press DISPLAY.

Recording TV programs using the VCR Plus+ system

Just enter the PlusCode number listed in the TV program guide. The date, time and channel number of that program are set automatically. You can preset up to eight programs at a time.

Before you start...

- Check that the VCR clock is set to the correct time.
- Turn on your TV and set it to the video channel. When using a cable box, turn it on.
- Insert a tape with its safety tab in place. Make sure the tape is longer than the total recording time.

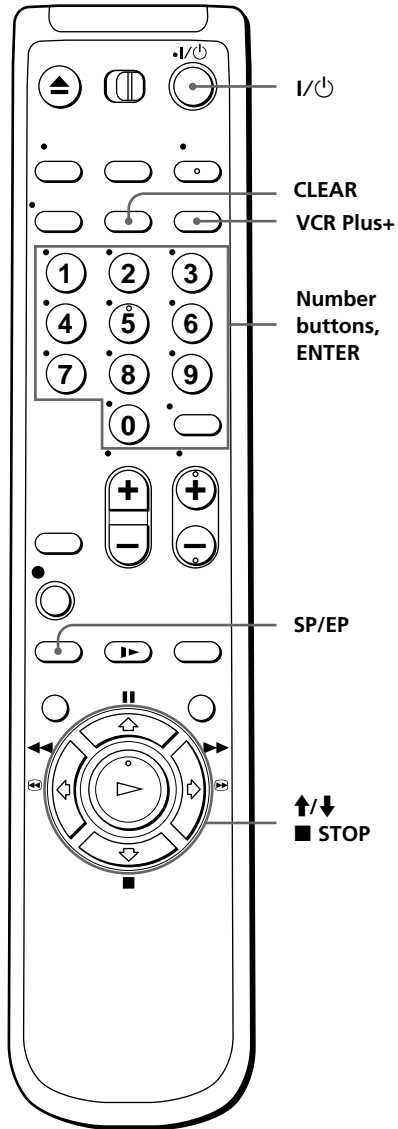

1  VCR Plus+

Press VCR Plus+.

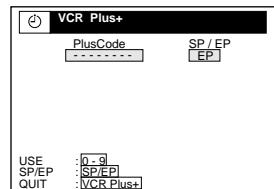

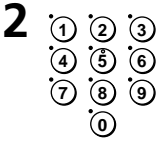

2 Press the number buttons to enter the PlusCode number.



If you make a mistake, press CLEAR and re-enter the correct number.

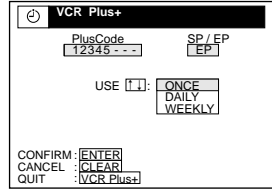

3 Press SP/EP to select the tape speed, SP or EP.

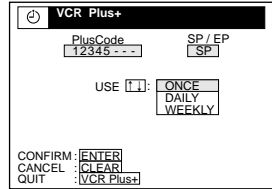

4 Press \uparrow/\downarrow to highlight ONCE, DAILY, or WEEKLY, then press ENTER:

To record	Select
Only once	ONCE
Everyday Monday to Friday	DAILY
Once a week	WEEKLY

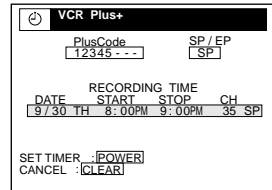

The date, start and stop time, channel number and tape speed appear on the TV screen. If the information is not correct, press CLEAR to cancel the setting.

5

To enter another setting, repeat steps 1 to 4.

6



Press I/O to turn off the VCR.

The ⏻ indicator appears in the display window and the VCR stands by for recording. When using a cable box, leave it on.

To stop recording

To stop the VCR while recording, press \blacksquare STOP.

continued

Recording TV programs using the VCR Plus+ system (continued)

To use the VCR after setting the timer

To use the VCR before a timer recording begins, just press I/⏻. The ⏻ indicator disappears from the display window and the VCR switches on. Remember to press I/⏻ to reset the VCR to the timer recording standby mode after using the VCR.

You can also do the following tasks while the VCR is recording:

- Reset the counter.
- Display tape information on the TV screen.
- Check the timer settings.
- Watch another TV program.

To lock the VCR after setting the timer (Child Lock)

While the VCR turns on, hold down I/⏻ POWER on the VCR until the 🔒 indicator appears in the display window. The VCR turns off and the 🔒 indicator remains lit. The VCR will not work except for timer recording.

To unlock the VCR, hold down I/⏻ POWER on the VCR until the 🔒 indicator disappears from the display window. The VCR is unlocked and turns on.

To stop timer recording while the VCR is locked, press ■ STOP. The recording stops and the VCR is unlocked.

Tips

- To cancel the VCR Plus+ system recording, press VCR Plus+ before pressing ENTER in step 4 above.
- When you are recording a program in the SP mode and the remaining tape becomes shorter than the recording time, the tape speed is automatically changed to the EP mode. Note that some noises will appear on the picture when the tape speed is changed. If you want to keep the tape speed, set AUTO TAPE SPEED to OFF in the ADVANCED OPTIONS menu (page 65).

Notes

- If the VCR does not accept the PlusCode number, this means that:
 - the PlusCode number is incorrect.
 - ONCE, DAILY, or WEEKLY was selected incorrectly. You cannot select DAILY or WEEKLY for a program that airs more than seven days ahead.
- The VCR will be unlocked when:
 - you stop timer recording by pressing ■ STOP
 - you insert a tape
 - the AC power cord is disconnected or power supply stops.

Setting the timer manually (continued)

2



Press **↑/↓** to highlight the line that is to be set, then press **OK**.

3



Set the date, start and stop time, channel number and tape speed:

1 Press **↑/↓** to set each item.

2 Press **→** to highlight and set each item in turn.

To correct a setting, press **←** to return to that setting and reset.

To record the same program every day or the same day every week, press **↓** while the date is highlighting. For details, see “Daily/weekly recording” below.

TIMER SET / CHECK					9 / 28 TU
DATE	START	STOP	CH		
9 / 30 TH	8 : 00PM	9 : 00PM	35 [SP]		
- / -	- - -	- - -	- - -		
- / -	- - -	- - -	- - -		
- / -	- - -	- - -	- - -		
- / -	- - -	- - -	- - -		
- / -	- - -	- - -	- - -		
- / -	- - -	- - -	- - -		
- / -	- - -	- - -	- - -		
RETURN					
SELECT	[←]		END: [OK]		
SET	[→]				
QUIT	[MENU]				



To record from a source connected to the LINE-1 IN jacks, press **INPUT SELECT** to display “L1” in the “CH” position.

4



Press **OK** to confirm the setting.

To enter another setting, highlight the next line and repeat step 3.

5



Press **MENU** to exit the menu.

6



Press **I/⏻** to turn off the VCR.

The **⏻** indicator appears in the display window and the VCR stands by for recording.

When using a cable box, leave it on.

To stop recording

To stop the VCR while recording, press **■ STOP**.

Daily/weekly recording

In step 3 above, press **↓** to select the recording pattern. Each time you press **↓**, the indication changes as shown below. Press **↑** to change the indication in reverse order.

the current date → **SU-SA** → **MO-SA** → **MO-FR** → **EVERY SA** → → **EVERY MO** → **EVERY SU** → **1 month later** → **(dates count down)** → **the current date**

To use the VCR after setting the timer

To use the VCR before a timer recording begins, just press **I/⏻**. The **⏻** indicator disappears from the display window and the VCR switches on. Remember to press **I/⏻** to reset the VCR to the timer recording standby mode after using the VCR.

You can also do the following tasks while the VCR is recording:

- Reset the counter.
- Display tape information on the TV screen.
- Check the timer settings.
- Watch another TV program.

To lock the VCR after setting the timer (Child Lock)

While the VCR turns on, hold down **I/⏻ POWER on the VCR** until the **⏻** indicator appears in the display window. The VCR turns off and the **⏻** indicator remains lit. The VCR will not work except for timer recording.

To unlock the VCR, hold down **I/⏻ POWER on the VCR** until the **⏻** indicator disappears from the display window. The VCR is unlocked and turns on.

To stop timer recording while the VCR is locked, press **■ STOP**. The recording stops and the VCR is unlocked.

Tips

- To set the channel, you can also use the CH +/- or number buttons.
- To set the tape speed, you can also use the SP/EP button.
- When you are recording a program in the SP mode and the remaining tape becomes shorter than the recording time, the tape speed is automatically changed to the EP mode. Note that some noises will appear on the picture when the tape speed is changed. If you want to keep the tape speed, set AUTO TAPE SPEED to OFF in the ADVANCED OPTIONS menu (page 65).
- If you want to return to the previous menu and continue with other operations after setting the timer, press **↓** to highlight RETURN, then press OK. The display returns to the MENU screen. If you are finished using the VCR, turn off the power before the timer recording starts.

Playing/searching at various speeds

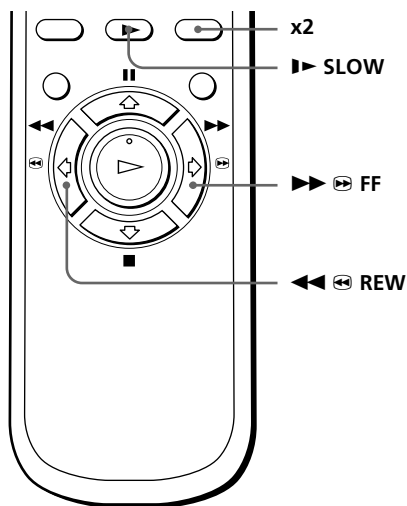
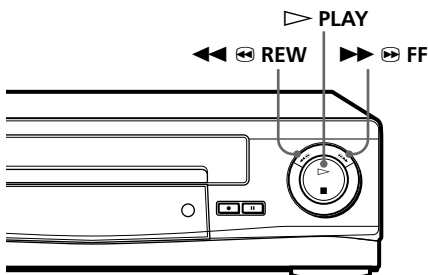

Playback options	Operation
View the picture during fast-forward or rewind	During fast-forward, hold down ►► ►► FF. During rewind, hold down ◀◀ ◀◀ REW.
Play at high speed	<ul style="list-style-type: none"> • During playback, press ►► ►► FF or ◀◀ ◀◀ REW <u>on the remote commander.</u> • During playback, hold down ►► ►► FF or ◀◀ ◀◀ REW. When you release the button, normal playback resumes.
Play at twice the normal speed	During playback, press x2.
Play in slow motion	During playback or pause, press ►► SLOW.
Play frame by frame	During pause, press ►► ►► FF or ◀◀ ◀◀ REW <u>on the remote commander.</u> Hold down the button to play one frame each second.
Rewind and start play	During stop, press ►► PLAY <u>on the VCR</u> while holding down ◀◀ ◀◀ REW <u>on the VCR.</u>

To resume normal playback

Press ►► PLAY.

Tip

- Adjust the picture using the TRACKING +/- buttons if:
 - Streaks appear while playing in slow motion.
 - The picture shakes while pausing.

To set tracking to the center position, press both buttons (+/-) at the same time.

Notes

- The sound is muted during these operations.
- Tapes recorded in the LP mode on other VCRs can be played back on this VCR but the picture quality cannot be guaranteed.
- The picture may have snow when playing at high speed in reverse.

Setting the recording duration time

After starting recording in the normal way, you can have the VCR stop recording automatically after a specified duration.

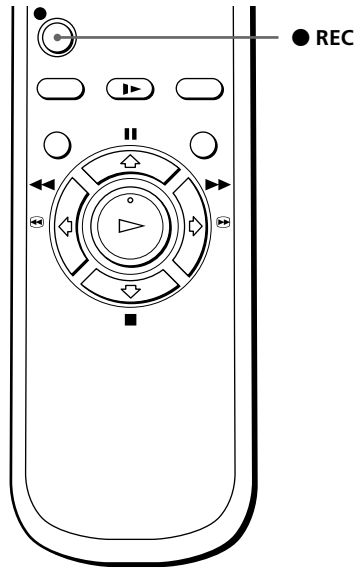

- 1 While recording, press ● REC.
The ⊖ indicator appears in the display window.

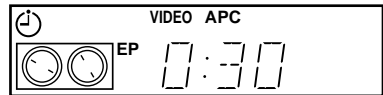

- 2 Press ● REC repeatedly to set the duration.
Each press advances the time in increments of 30 minutes.

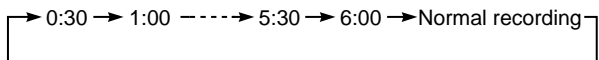

The tape counter decreases minute by minute to 0:00, then the VCR stops recording and turns off automatically.

To extend the duration

Press ● REC repeatedly to set a new duration.

To cancel the duration

Press ● REC repeatedly until ⊖ indicator disappears and the VCR returns to normal recording mode.

To stop while recording

Press ■ STOP.

Note

- You cannot display the current tape time in the display window when setting the recording duration.

Checking/ changing/ canceling timer settings

Before you start...

- Turn on your TV and set it to the video channel.

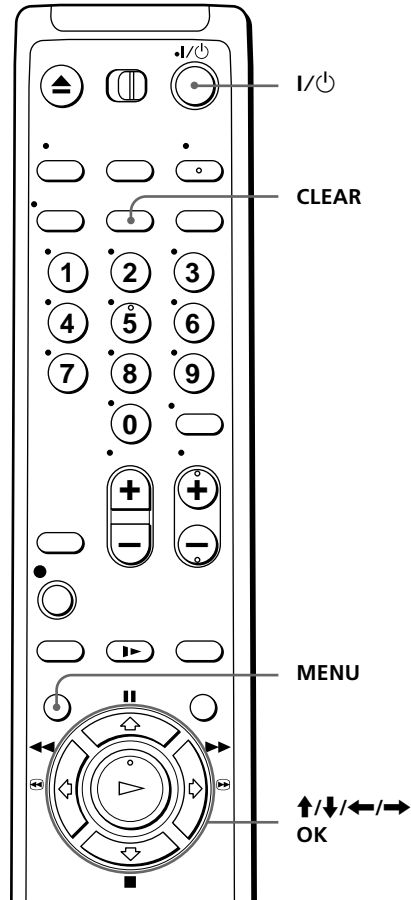

- 1** Press I/⏻ to turn on the VCR.
- 2** Press MENU, then press ↑/↓ to highlight TIMER SET/CHECK and press OK.
 - If you want to change a setting, go on to the next step.
 - If you do not need to change the settings, press MENU, then turn off the VCR to return to recording standby.

continued

Checking/changing/canceling timer settings (continued)

3 Press **↑/↓** to highlight the setting you want to change or cancel.

- To change the setting, press **OK** and press **←/→** to highlight the item you want to change, then press **↑/↓** to reset it.
- To cancel the setting, press **CLEAR**.

TIMER SET / CHECK					9/28 TU	
DATE	START	STOP	CH	SP		
9/30	TH 8:00PM	9:00PM	35	SP		
10/2	SA 10:00AM	11:30AM	20	EP		
MO - FR	2:00PM	3:00PM	60	EP		
EVERY SU	6:30AM	7:00AM	42	EP		
-/-	-:-	-:-	-:-	-:-		
-/-	-:-	-:-	-:-	-:-		
-/-	-:-	-:-	-:-	-:-		
RETURN						
SELECT:	[] [] [] []					
SET	:OK		CANCEL: CLEAR			
QUIT	:MENU					

4 Press **OK**.

5 Press **MENU** to exit the menu.

If any timer settings remain, turn off the VCR to return to recording standby.

When the timer settings overlap

The program that starts first has priority and the second program starts recording only after the first program has finished. If the programs start at the same time, the program listed first in the menu has priority.

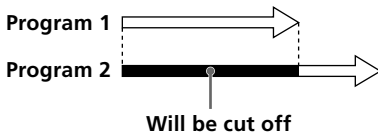

Recording stereo and bilingual programs

Recording stereo programs

This VCR automatically receives and records stereo programs. When a stereo program is received, the STEREO indicator lights up. If there is noise in the stereo program, set AUTO STEREO in the ADVANCED OPTIONS menu to OFF. The sound will be recorded in monaural (on both hi-fi and normal audio tracks) but with less noise. For details, see page 64.

Recording bilingual programs

Normally, this VCR records only the main sound. When a SAP (Second Audio Program) is received, the SAP indicator lights up. To record only SAP sound, set TUNER AUDIO in the ADVANCED OPTIONS menu to SAP. For details, see page 64.

Selecting the sound during playback

Press AUDIO MONITOR to select the sound you want. (The sound being recorded will not change.)

To listen to	On-screen display	Display window
Stereo	STEREO	STEREO
Left channel	L	STEREO
Right channel	R	STEREO
Monaural sound on the normal audio track	No indicator	No indicator

continued

Recording stereo and bilingual programs (continued)

How sound is recorded on a video tape

The VCR records sound onto two separate tracks. Hi-fi audio is recorded onto the main track along with the picture. Monaural sound is recorded onto the normal audio track along the edge of the tape.

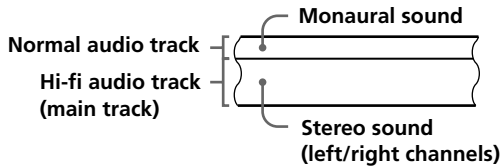



Notes

- To play a tape in stereo, you must use the A/V connections.
- When you play a tape recorded in monaural, the sound is heard in monaural regardless of the AUDIO MONITOR setting.

Adjusting the picture

Adjusting the tracking

Although the VCR automatically adjusts the tracking when playing a tape (the  indicator flashes in the display window, then goes off), distortion may occur if the tape was recorded in poor condition. In this case, manually adjust the tracking.

Press TRACKING +/- to display the tracking meter. The distortion should disappear as you press one of the two buttons (the  indicator lights up). To resume automatic tracking adjustment, eject the tape and reinsert it.

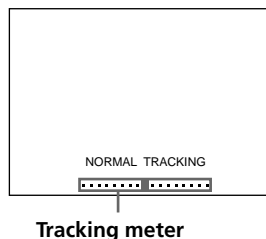

About the Adaptive Picture Control (APC) function

The Adaptive Picture Control (APC) function automatically improves recording and playback quality by adjusting the VCR to the condition of the video heads and tape. To maintain better picture quality, we recommend that you set APC to ON in the ADVANCED OPTIONS menu (with the APC indicator in the display window lit). For details, see page 64.

APC playback

The APC function automatically works on all types of tapes, including rental tapes and tapes that were not recorded with APC.

APC recording

Whenever you insert a tape and first start recording, the VCR adjusts to the tape using the APC function (the APC indicator flashes rapidly). This adjustment is retained until the tape is ejected.

Notes

- Auto tracking adjustment cannot be guaranteed to work with tapes recorded in LP mode on other VCRs.
- The APC function does not work if the tape speed is automatically changed from the SP to EP mode during a timer recording when AUTO TAPE SPEED is set to ON in the ADVANCED OPTIONS menu, unless the tape has been recorded in the EP mode with the APC function.
- There is a delay of about ten seconds before the VCR actually starts recording while the VCR analyzes the tape. To avoid the delay, first set the VCR to recording pause (the APC indicator flashes slowly) and press ● REC to have the VCR analyze the tape (the APC indicator flashes rapidly). After the APC indicator stops flashing, press ■ PAUSE to start recording immediately.

If you want to start recording quickly without using the APC function, first set the VCR to recording pause (the APC indicator flashes slowly) and press ■ PAUSE to start recording.

Changing menu options

- 1 Press MENU, then select **ADVANCED OPTIONS** and press OK.

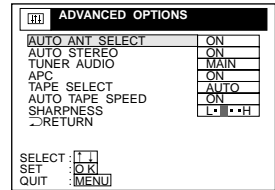

- 2 Press **↑/↓** to highlight the option to change, then press OK.
- 3 Press **↑/↓** to change the setting, then press OK.
To adjust the sharpness, press **←/→** and press OK.
- 4 Press MENU to return to the original screen.

Menu choices

Initial settings are indicated in bold print.

Menu option	Set this option to
AUTO ANT SELECT	<ul style="list-style-type: none"> • ON if your TV is connected only to VHF/UHF OUT on the VCR. To play a tape, set the TV to the VCR channel (channel 3 or 4). • OFF if your TV is connected to both VHF/UHF OUT and LINE OUT on the VCR. To play a tape, set the TV to the VCR input.
AUTO STEREO	<ul style="list-style-type: none"> • ON to receive stereo programs. • OFF to reduce noise. The sound changes to monaural.
TUNER AUDIO	<ul style="list-style-type: none"> • MAIN to record the main sound on both hi-fi and normal audio tracks. • SAP to record the SAP (Second Audio Program) sound on both hi-fi and normal audio tracks.
APC	<ul style="list-style-type: none"> • ON to switch on the APC (Adaptive Picture Control) function and improve picture quality. • OFF to switch off APC.

Menu option	Set this option to
TAPE SELECT	<ul style="list-style-type: none"> • AUTO when using a T-160 length tape or any tape shorter than a T-140 length tape. • 180 when using a T-140 or T-180 length tape. For details, see page 49.
AUTO TAPE SPEED	<ul style="list-style-type: none"> • ON to change the timer recording tape speed automatically to the EP mode when the remaining tape length becomes shorter than the recording time. To operate AUTO TAPE SPEED, set TAPE SELECT correctly. • OFF to keep the tape speed.
SHARPNESS	L (Low) through H (High) to adjust the sharpness of the picture. L to turn off the sharpness control.

Editing with another VCR

How to hook up to record on this VCR

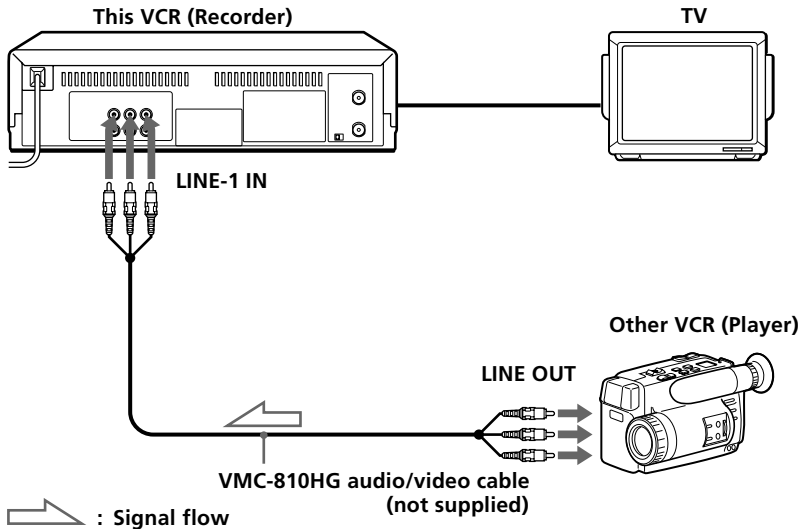

Notes

- Make sure you connect the plugs to jacks of the same color.
- If you connected this VCR to both the LINE IN and LINE OUT jacks of the other VCR, select the input correctly to prevent a humming noise.
- You can use the LINE-1 IN jacks for editing. If the other VCR is a monaural type, the sound is recorded only on the channel whose jack is connected to the audio plug. To record on both right and left channels, connect the audio plugs to the AUDIO R/L jacks using a VMC-910HG audio/video cable (not supplied).

Operation (when recording on this VCR)

Before you start editing

- Turn on your TV and set it to the video channel.
- Press INPUT SELECT to display “L1” in the display window.
- Press SP/EP to select the tape speed, SP or EP.

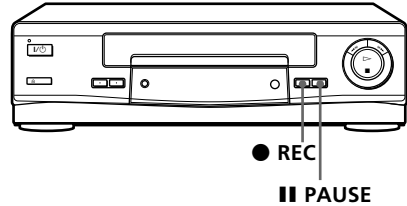

- 1** Insert a source tape with its safety tab removed into the other (playback) VCR. Search for the point to start playback and set it to playback pause.
- 2** Insert a tape into this (recording) VCR. Search for the point to start recording and press **II PAUSE**.
- 3** Press **● REC** on this VCR and set it to recording pause.
- 4** To start editing, press the **II PAUSE** buttons on both VCRs at the same time.

To stop editing

Press the **■ STOP** buttons on both VCRs.

Tip

- To cut out unwanted scenes while editing, press **II PAUSE** on this VCR when an unwanted scene begins. When it ends, press **II PAUSE** again to resume recording.

Note

- If you start recording following the procedure above, the VCR won't start recording with the APC function. To record a tape with the APC function, press **● REC** again during recording pause in step 3 so that the VCR analyzes the tape. Then when you start recording in step 4, press **II PAUSE** immediately after the APC indicator stops flashing. If you press **II PAUSE** before the APC indicator stops flashing, the APC function is canceled.

General setup information

Setting the RF unit

When connecting the VCR to the TV using only the antenna cable, you must set the RF UNIT switch on the rear of the VCR so that the TV can receive the correct signal from the VCR.

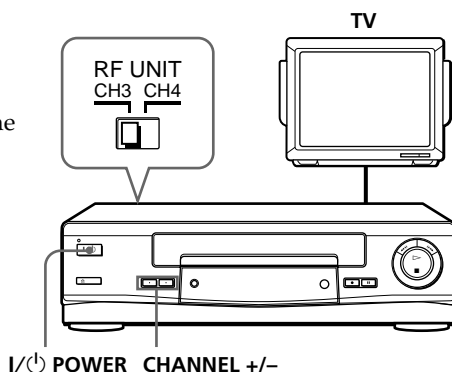

- 1** Set the RF UNIT switch on the rear of the VCR to CH3 or CH4, whichever channel is not used in your area. If both are used, set the switch to either channel.
- 2** Press I/⏻ POWER to turn on the VCR.
- 3** Press TV/VIDEO to turn on the VIDEO indicator in the VCR's display window.
- 4** Press CHANNEL +/- to display a channel number in the display window. Select an active channel number in your area.
- 5** Turn on your TV and set it to the channel you selected in step 1 (channel 3 or 4).

The channel you selected in step 4 appears on the TV screen. If the channels change when you press CHANNEL +/-, you have made the correct setting.

Whenever you use the VCR, set the TV to the channel selected in step 1.

Attaching the external antenna connector

When using a 300-ohm twin lead cable for VHF/UHF antenna, use the EAC-32 antenna connector (not supplied) to connect the antenna to the VCR.

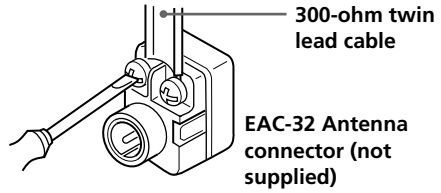

- 1 Loosen the screws on the antenna connector.
- 2 Wind the twin leads around the screws on the antenna connector.
- 3 Retighten the screws.

Attaching a UHF/VHF band mixer

When using both 75-ohm coaxial cable and 300-ohm twin lead cable for VHF/UHF antenna, use the EAC-66 UHF/VHF band separator/mixer (not supplied) to connect the antenna to the VCR.

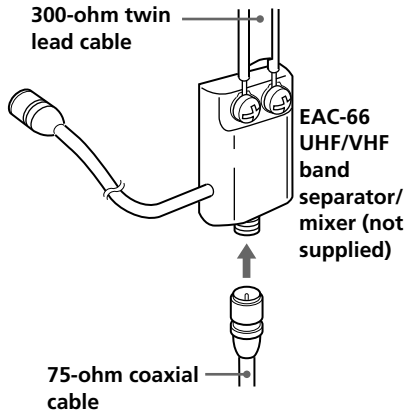

- 1 Loosen the screws on the mixer.
- 2 Wind the twin leads around the screws on the mixer.
- 3 Retighten the screws.
- 4 Connect the 75-ohm coaxial cable to the mixer.

Troubleshooting

If you have any questions or problems not covered below, please consult your nearest Sony dealer.

	Symptom	Remedy
Power	The I/⏻ switch does not function.	<ul style="list-style-type: none"> • Connect the AC power cord securely. • Make sure the VCR is not locked. To unlock, hold down I/⏻ POWER <u>on the VCR</u> until the  indicator disappears.
	The power is turned on but the VCR does not operate.	<ul style="list-style-type: none"> • Moisture condensation occurs. Turn the power off, unplug the AC power cord and leave the VCR to dry for over three hours.
Clock	The clock has stopped and "--:--" lights in the display window.	<ul style="list-style-type: none"> • The clock stops if the VCR is disconnected from the wall outlet for more than one hour. Reset the clock (and the timer).
Playback	The playback picture does not appear on the TV screen.	<ul style="list-style-type: none"> • Make sure the TV is set to the channel for the VCR. If you are using a monitor, set it to video input.
	The picture is not clear.	<ul style="list-style-type: none"> • Adjust the tracking with the TRACKING +/- buttons. • The video heads are dirty (see below). Clean the video heads using the Sony T-25CLD, T-25CLDR, or T-25CLW video head cleaning cassette. If these cleaning cassettes are not available in your area, have the heads cleaned at your nearest Sony service facility (a standard service fee will be charged). Do not use a commercially available liquid-type cleaning cassette other than Sony's, as it may damage the video heads. • The video heads may have to be replaced. Consult your local Sony dealer for more information.
	The picture rolls vertically during picture search.	<ul style="list-style-type: none"> • Adjust the vertical hold control on the TV or monitor.
	The picture has no sound.	<ul style="list-style-type: none"> • The tape is defective. • If you made A/V connections, check the audio cable connection.

Symptoms caused by contaminated video heads

• Normal picture



• Rough picture



initial
contamination

• Unclear picture



• No picture (or
black & white
screen appears)



terminal



	Symptom	Remedy
Recording	A TV program does not appear on the TV screen.	<ul style="list-style-type: none"> • Make sure the TV is set to the channel for the VCR. If you are using a monitor, set it to video input. • Select the correct source with the INPUT SELECT button. Select a channel number when recording TV programs; select "L1" when recording from other equipment.
	TV reception is poor.	<ul style="list-style-type: none"> • Adjust the TV antenna.
	The tape starts playing as soon as it is inserted.	<ul style="list-style-type: none"> • The safety tab has been removed. To record on this tape, cover the tab hole.
	The tape ejects when you press ● REC.	<ul style="list-style-type: none"> • Check that the safety tab has not been removed.
Timer recording	Nothing happens when you press ● REC.	<ul style="list-style-type: none"> • Make sure the tape is not at its end.
	The timer does not operate.	<ul style="list-style-type: none"> • Check that the clock is set. • Make sure a tape has been inserted. • Check that the safety tab has not been removed. • Make sure the tape is not at its end. • Make sure a program has been set for timer recording. • Make sure your timer settings have not already passed the current time. • Check that the cable box is turned on. • The clock stops if the VCR is disconnected from the wall outlet for more than one hour. Reset the clock and timer.
Others	A tape cannot be inserted.	<ul style="list-style-type: none"> • Check that a tape isn't already in the tape compartment.
	The remote commander does not function.	<ul style="list-style-type: none"> • Make sure you are pointing the remote commander at the remote sensor on the VCR. • Replace all the batteries in the remote commander with new ones if they are weak. • Make sure the [TV]/[VIDEO] switch is set correctly.
	The tracking meter does not appear on the screen.	<ul style="list-style-type: none"> • The recording condition of the tape is very poor and tracking cannot be adjusted.
	You cannot control other TVs.	<ul style="list-style-type: none"> • Set your TV's code number. The code number may change when you replace the batteries of the remote commander.
	The VCR needs to be cleaned.	<ul style="list-style-type: none"> • Clean the cabinet, panel and controls with a dry, soft cloth, or a soft cloth slightly moistened with a mild detergent solution. Do not use any type of solvent, such as alcohol or benzine.

Specifications

System

- Format
 - VHS NTSC standard
- Video recording system
 - Rotary head helical scanning FM system
- Video heads
 - Double azimuth four heads
- Video signal
 - NTSC color, EIA standards
- Tape speed
 - SP: 33.35 mm/s ($1\frac{3}{8}$ inches/s)
 - EP: 11.11 mm/s ($\frac{7}{16}$ inches/s)
 - LP: 16.67 mm/s ($1\frac{1}{16}$ inches/s), playback only
- Maximum recording/playback time
 - 8 hrs. in EP mode (with T-160 tape)
- Fast-forward and rewind time
 - Approx. 3 min. (with T-120 tape)

Tuner section

- Channel coverage
 - VHF 2 to 13
 - UHF 14 to 69
 - CATV A-8 to A-1, A to W, W+1 to W+84
- Antenna
 - 75-ohm antenna terminal for VHF/UHF

Inputs and outputs

- LINE-1 IN
 - VIDEO IN, phono jack (1)
 - Input signal: 1 Vp-p, 75 ohms, unbalanced, sync negative
 - AUDIO IN, phono jacks (2)
 - Input level: 327 mVrms
 - Input impedance: more than 47 kilohms
- LINE OUT
 - VIDEO OUT, phono jack (1)
 - Output signal: 1 Vp-p, 75 ohms, unbalanced, sync negative
 - AUDIO OUT, phono jacks (2)
 - Standard output: 327 mVrms
 - Load impedance: 47 kilohms
 - Output impedance: less than 10 kilohms

Timer section

- Lock
 - Quartz locked
- Timer indication
 - 12-hour cycle
- Timer setting
 - 8 programs per month (max.)
- Power back-up
 - Built-in self-charging capacitor
 - Back-up duration: up to 1 hour at a time

General

- Power requirements
 - 120 V AC, 60 Hz (SLV-662HF/679HF)
 - 110 V AC to 240 V AC, 50/60 Hz (SLV-679HF PX)
- Power consumption
 - 24 W (SLV-662HF/679HF)
 - 19 W (SLV-679HF PX)
- Operating temperature
 - 5°C to 40°C (41°F to 104°F)
- Storage temperature
 - 20°C to 60°C (-4°F to 140°F)
- Dimensions
 - Approx. 355 × 96 × 285 mm (w/h/d)
 - (Approx. $14 \times 3\frac{7}{8} \times 11\frac{1}{4}$ inches) including projecting parts and controls
- Mass
 - Approx. 3.6 kg (7 lb 15 oz)

Supplied accessories

- Remote commander (1)
- Size AA (R6) batteries (2)
- 75-ohm coaxial cable with F-type connectors (1)
- Audio/video cable (3 phono to 3 phono) (1)
- Plug adaptor (1) (SLV-679HF PX only)

Design and specifications are subject to change without notice.

ENERGY STAR is a U.S. registered mark. As an ENERGY STAR Partner, Sony Corporation has determined that this product meets the ENERGY STAR guidelines for energy efficiency. (SLV-662HF/679HF only)

Index to parts and controls

Refer to the pages indicated in parentheses () for details.

Front panel

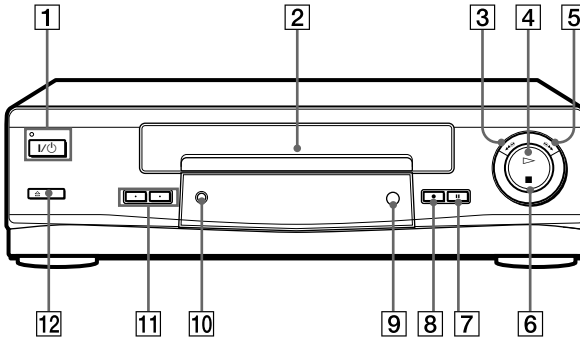

- | | |
|---|---|
| 1 I/⏻ POWER switch/indicator (51) | 7 PAUSE button (45, 67) |
| 2 Tape compartment | 8 ● REC (record) button (48, 58, 67) |
| 3 ◀◀ ⏮ REW (rewind) button (45, 56) | 9 Remote sensor (5) |
| 4 ▷ PLAY button (45, 56) | 10 EASY SET UP button (11, 14, 18, 21) |
| 5 ▶▶ ⏭ FF (fast-forward) button (45, 56) | 11 CHANNEL/TRACKING +/- buttons (48, 63) |
| 6 ■ STOP button (45, 67) | 12 ▲ EJECT button (45) |

continued

Display window

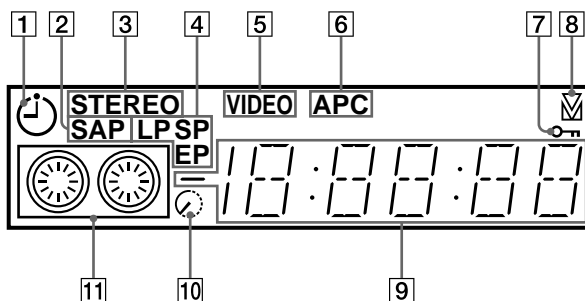

- | | |
|--|---|
| 1 Timer indicator (51, 54) | 7 Child Lock indicator (52) |
| 2 SAP (Second Audio Program) indicator (61) | 8 Tracking indicator (63) |
| 3 STEREO indicator (61) | 9 Time counter/clock/line/channel indicator (46, 48, 67) |
| 4 Tape speed indicator (48) | 10 Remaining time indicator (49) |
| 5 VIDEO indicator (49, 68) | 11 Tape/recording indicator (48) |
| 6 APC (Adaptive Picture Control) indicator (63) | |

Rear panel

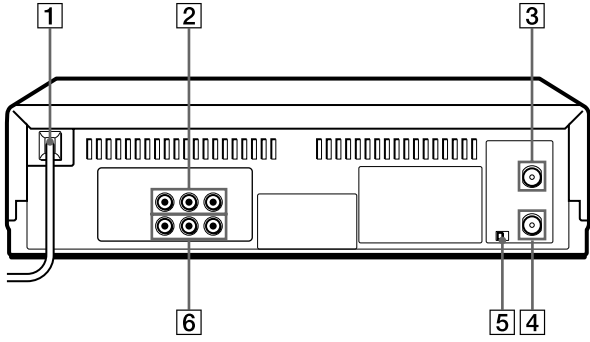

- 1** AC power cord (7)
- 2** LINE-1 IN AUDIO R/L/VIDEO jacks (66)
- 3** VHF/UHF IN connector (10, 13, 17, 20)
- 4** VHF/UHF OUT connector (10, 13, 17, 20)
- 5** RF (Radio Frequency) UNIT switch (68)
- 6** LINE OUT AUDIO R/L/VIDEO jacks (8)

continued

Remote commander

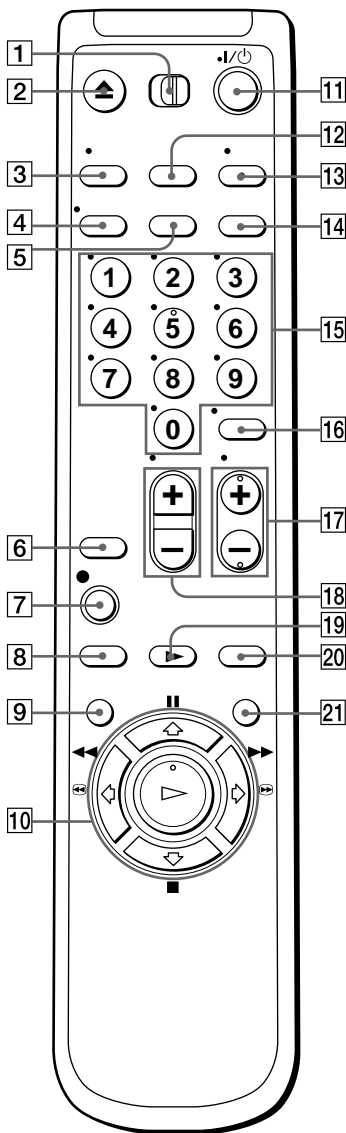

- 1 TV/VIDEO switch (5)
- 2 ▲ EJECT button (45)
- 3 TV/VIDEO button (6, 49)
- 4 DISPLAY button (49)
- 5 CLEAR button (46, 51, 60)
- 6 INPUT SELECT button (48, 49, 67)
- 7 ● REC (record) button (48, 58)
- 8 SP (Standard Play)/EP (Extended Play) button (48)
- 9 MENU button (25, 53, 59)
- 10 || PAUSE/▲ button (25, 45)
■ STOP/▼ button (25, 45)
◀◀ ◀ REW (rewind)/← button (45, 56)
▶▶ ▶ FF (fast-forward)/→ button (45, 56)
▷ PLAY/OK button (25, 45)

-
- 11 I/⏻ (power) switch (6, 51)
 - 12 COUNTER/REMAIN button (49)
 - 13 AUDIO MONITOR button (61)
 - 14 VCR Plus+ button (50)
 - 15 Number buttons (51)
 - 16 ENTER button (51)
 - 17 CH (channel) +/- buttons (6, 48)
 - 18 VOL (volume) +/- buttons (6)
 - 19 ▶ SLOW button (56)
 - 20 x2 button (56)
 - 21 SMART CUE button (45)

Index

A, B

- Adjusting
 - picture 63
 - tracking 63
- Advanced option 64
- AFT (Auto Fine Tuning) 38
- Antenna hookup 10
- APC (Adaptive Picture Control) 63
- Audio track 62
- Audio/video (A/V) hookup 8
- Auto Clock Set 29
- Auto Tape Speed 65

C

- Cable hookup 7
- Channel line-up chart 40
- Child Lock 52
- Cleaning the video heads 70
- Clock setting 26
- Connecting
 - cable TV 7
 - external antenna connector 69
 - UHF/VHF band mixer 69
- Counter 46

D

- Disabling channels 36
- Dubbing *See* Editing

E, F, G

- Easy Set Up 11, 14, 18, 21
- Editing 66
- EP mode 48

H, I, J, K

- Hi-fi audio track 62

L

- Language selecting 25
- Locking the VCR 52
- LP mode 49

M

- Monaural 61
- Monitoring audio during playback 61

N, O

- Normal audio track 62

P, Q

- Picture adjustment *See* Adjusting
- Playback 44
 - at various speeds 56
 - frame-by-frame 56
 - selecting the sound 61
 - skip 45
 - slow motion 56
- Presetting channels 34

R

- Recording 47
 - bilingual programs 61
 - SAP broadcasts 61
 - saving 49
 - stereo broadcasts 61
 - timer setting 53
 - using VCR Plus+ 50
 - while watching another program 49
- RF channel 68

S

- Safety tab 49
- SAP (Second Audio Program) 61
- Searching at various speeds 56
- SP mode 48
- Stereo 61

T, U

- Timer setting 53
 - canceling 59
 - changing 59
 - checking 59
 - daily/weekly recording 55
 - using VCR Plus+ 50
- Tracking adjustment *See* Adjusting
- Tuner presetting 34

V, W, X, Y, Z

- VCR Plus+
 - channel setup 40
 - recording 50

Quick reference to using the VCR

Hookup 1

To play a tape

- 1 Set the TV to channel 3 or 4 (or to video input, if you made A/V connections.)
- 2 Insert a tape and press \triangleright PLAY. If there's no picture on your TV, press the VCR's TV/VIDEO button until the VIDEO indicator comes on in the display window.

To record a program

- 1 Press VCR Plus+ on the remote commander.
- 2 Enter the PlusCode number.
- 3 Select ONCE, DAILY, or WEEKLY, then press ENTER.
- 4 Insert a tape.
- 5 Press I/⏻ to turn off the VCR.

To watch TV

- 1 Turn off the VCR, or press the VCR's TV/VIDEO button until the VIDEO indicator in the display window goes off.
- 2 Set the TV to the channel you want to watch.

Hookup 2

To play a tape

- 1 Set the TV to channel 3 or 4 (or to video input, if you made A/V connections.)
- 2 Insert a tape and press \triangleright PLAY.

To record a program

- 1 Turn on the cable box.
- 2 Set the cable box to the channel you want to record.
- 3 Press VCR Plus+ on the remote commander.
- 4 Enter the PlusCode number.
- 5 Select ONCE, DAILY, or WEEKLY, then press ENTER.
- 6 Insert a tape.
- 7 Press I/⏻ to turn off the VCR.
- 8 Leave the cable box on.

To watch TV

- 1 Turn off your VCR, or press the VCR's TV/VIDEO button until the VIDEO indicator in the display window goes off.
- 2 Turn on your cable box.
- 3 Set the TV to the cable box output channel (usually 2, 3, or 4).
- 4 Set the cable box to the channel you want to watch.

Hookup 3

To play a tape

- 1 If you made A/V connections, set the TV to video input. If you didn't use A/V hookup:
 - Turn on the cable box.
 - Set the cable box to channel 3 or 4.
 - Set the TV to the output channel of the cable box (usually 2, 3 or 4).
- 2 Insert a tape and press \triangleright PLAY.

To record a program

- 1 Press VCR Plus+ on the remote commander.
- 2 Enter the PlusCode number.
- 3 Select ONCE, DAILY, or WEEKLY, then press ENTER.
- 4 Insert a tape.
- 5 Press I/⏻ to turn off the VCR.

To watch TV

- 1 Turn off your VCR, or press the VCR's TV/VIDEO button until the VIDEO indicator in the display window goes off.
- 2 Select the channel with your cable box (if you have one) or with your TV.

If you have any questions about this product, you may call: **Sony Customer Information Center** 1-800-222-SONY (7669) or write to: **Sony Customer Information Center** Sony Drive, Mail Drop #T1-11, Park Ridge, NJ 07656

Sony  line <http://www.world.sony.com/>