

# *Mini Hi-Fi Component System*

---

## Operating Instructions

### Owner's Record

The model and serial numbers are located on the rear panel. Record the serial number in the space provided below. Refer to them whenever you call upon your Sony dealer regarding this product.

Model No. \_\_\_\_\_ Serial No. \_\_\_\_\_



*MHC-GRX9900 / GRX70 / GRX70J  
MHC-GRX50 / R770  
MHC-RXD9 / RXD80  
MHC-RXD7*

## WARNING

To prevent fire or shock hazard, do not expose the unit to rain or moisture.

To avoid electrical shock, do not open the cabinet. Refer servicing to qualified personnel only.

Do not install the appliance in a confined space, such as a bookcase or built-in cabinet.



This appliance is classified as a CLASS 1 LASER product. The CLASS 1 LASER PRODUCT MARKING is located on the rear exterior.

## NOTICE FOR THE CUSTOMERS IN THE U.S.A.

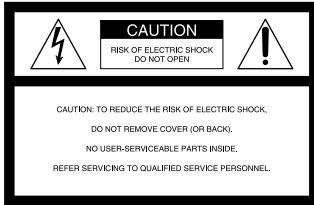

This symbol is intended to alert the user to the presence of uninsulated "dangerous voltage" within the product's enclosure that may be of sufficient magnitude to constitute a risk of electric shock to persons.



This symbol is intended to alert the user to the presence of important operating and maintenance (servicing) instructions in the literature accompanying the appliance.

## CAUTION

The use of optical instruments with this product will increase eye hazard.

## INFORMATION

This equipment has been tested and found to comply with the limits for a Class B digital device, pursuant to Part 15 of the FCC Rules. These limits are designed to provide reasonable protection against harmful interference in a residential installation. This equipment generates, uses, and can radiate radio frequency energy and, if not installed and used in accordance with the instructions, may cause harmful interference to radio communications. However, there is no guarantee that interference will not occur in a particular installation. If this equipment does cause harmful interference to radio or television reception, which can be determined by turning the equipment off and on, the user is encouraged to try to correct the interference by one or more of the following measures:

- Reorient or relocate the receiving antenna.
- Increase the separation between the equipment and receiver.
- Connect the equipment into an outlet on a circuit different from that to which the receiver is connected.
- Consult the dealer or an experienced radio/TV technician for help.

## CAUTION

You are cautioned that any changes or modifications not expressly approved in this manual could void your authority to operate this equipment.

## NOTICE FOR THE CUSTOMERS IN CANADA

### CAUTION:

TO PREVENT ELECTRIC SHOCK, DO NOT USE THIS POLARIZED AC PLUG WITH AN EXTENSION CORD, RECEPTACLE OR OTHER OUTLET UNLESS THE BLADES CAN BE FULLY INSERTED TO PREVENT BLADE EXPOSURE.

This stereo system is equipped with the Dolby B-type noise reduction system\*.

\* Manufactured under license from Dolby Laboratories Licensing Corporation. DOLBY and the double-D symbol  are trademarks of Dolby Laboratories Licensing Corporation.



A946

---

# Table of Contents

---

## Getting Started

Step 1: Hooking up the system .....	5
Step 2: Setting the time .....	7
Step 3: Presetting radio stations .....	8
Saving the power in standby mode ...	10

## Basic Operations

Playing a CD .....	11
Recording a CD .....	13
Listening to the radio .....	14
Recording from the radio .....	15
Playing a tape .....	16
Recording from a tape .....	18

## The CD Player

Using the CD display .....	19
Playing the CD tracks repeatedly .....	20
Playing the CD tracks in random order .....	21
Programming the CD tracks .....	22
Playing CDs without interruption .....	23

## The Tape Deck

Recording on a tape manually .....	24
Recording a CD by specifying track order .....	25

## DJ Effects

Looping part of a CD .....	27
Flashing part of a CD .....	27

## Sound Adjustment

Adjusting the sound .....	28
Selecting the audio emphasis .....	29
Changing the spectrum analyzer display .....	31
Selecting surround effects .....	31
Adjusting the graphic equalizer .....	32
Making a personal audio emphasis file .....	33

## Other Features

Using the Radio Data System (RDS)*	34
Singing along: Karaoke .....	36
Falling asleep to music .....	38
Waking up to music .....	39
Timer-recording radio programs .....	40

## Optional AV components

Connecting audio components .....	41
Connecting a VCR .....	43
Connecting the surround speakers .....	43
Connecting outdoor antennas .....	44

## Additional Information

Precautions .....	45
Troubleshooting .....	46
Specifications .....	49
Parts identification .....	54
Index .....	Back cover

\* European model only

# Using this manual

The instructions in this manual are for MHC-GRX9900/GRX70/GRX70J/GRX50/R770/RXD9/RXD80/RXD7. The MHC-RXD80 is the model used for illustration purposes. Otherwise, the model name is indicated in the illustrations. The shape of the buttons on the MHC-GRX9900/RXD9 is different from that of the MHC-GRX70, but the locations of the buttons are the same. Any differences in operation are clearly indicated in the text, for example, “MHC-GRX70 only” or “European model only”.

## MHC-GRX70/GRX70J/GRX50/R770/RXD80/RXD7

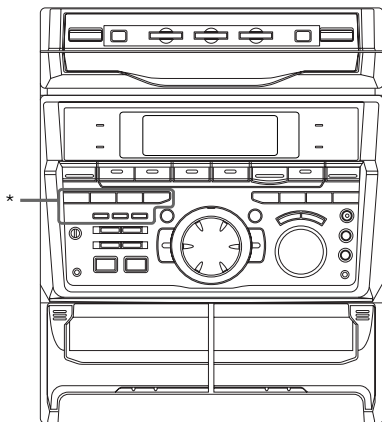

## MHC-GRX9900/RXD9

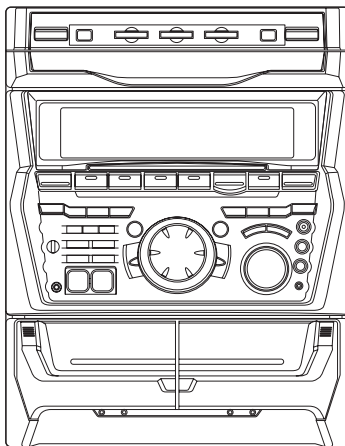

\* This part of the MHC-GRX50/R770/RXD7 is different from other models as below:

### MHC-GRX50/R770/RXD7

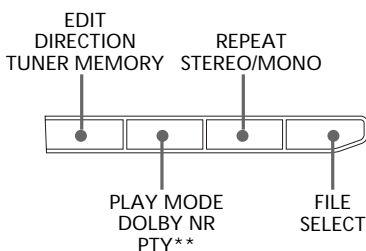

### MHC-GRX70/GRX70J/RXD80 MHC-GRX9900/RXD9

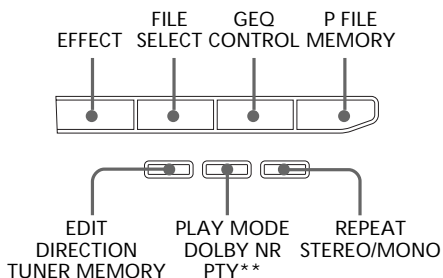

\*\* “PTY” is for European model only.

## Step 1: Hooking up the system

Do the following procedure **1** to **4** to hook up your system using the supplied cords and accessories.

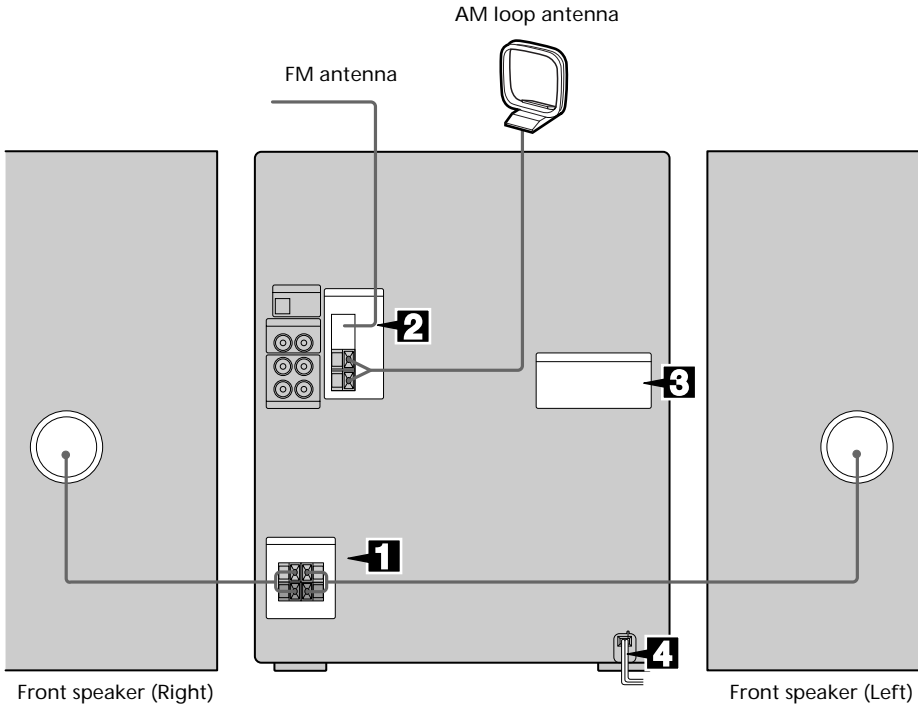

### **1** Connect the speakers.

Connect the speaker cords of front speakers to the SPEAKER jacks as below. For the front speakers with jacks, connect the speaker cords to the speakers in the same way.

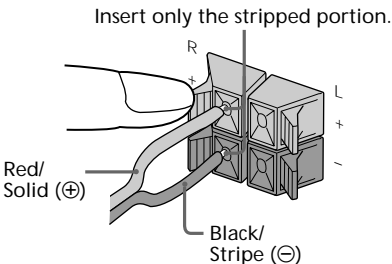

### Notes

- Keep the speaker cords away from the antennas to prevent noise.
- The type of speakers supplied vary according to the model you purchased (see "Specifications" on page 52).

continued

## Step 1: Hooking up the system (continued)

### 2 Connect the FM/AM antennas.

Set up the AM loop antenna, then connect it.

#### Jack type ①

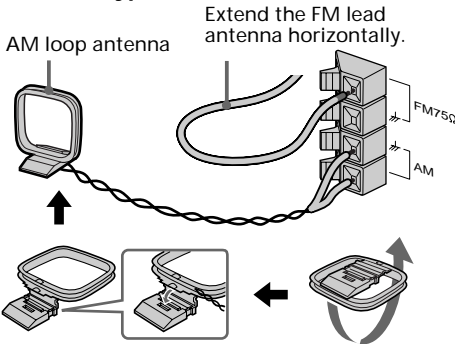

#### Jack type ②

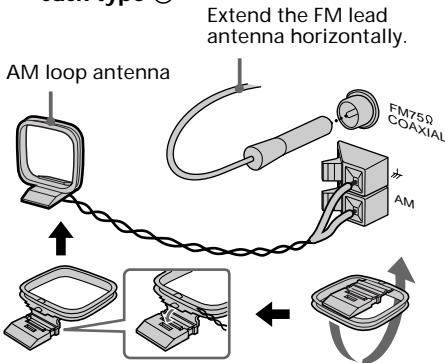

- ### 3
- For models with a voltage selector, set **VOLTAGE SELECTOR** to position of your local power line voltage.

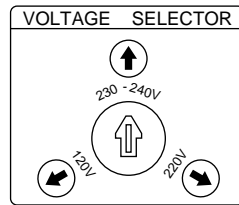

- ### 4
- Connect the power cord to a wall outlet.

The demonstration appears in the display. When you press **| / ⏻**, the system turns on and the demonstration automatically ends.

If the supplied adapter on the plug does not fit your wall outlet, detach it from the plug (only for models equipped with an adapter).

## To connect optional AV components

See page 41.

## To deactivate the demonstration

When you set the time (Step 2: Setting the time), the demonstration is deactivated.

To activate/deactivate the demonstration again, press **DISPLAY** (MHC-RXD9/RXD80/RXD7/R770) or **DEMO (STANDBY)** (MHC-GRX9900/GRX70/GRX70J/GRX50) while the system is off.

## To attach the front speaker pads

Attach the supplied front speaker pads to the bottom of the speakers to stabilize the speakers and prevent them from slipping.

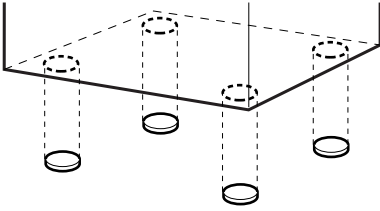

## Inserting two size AA (R6) batteries into the remote

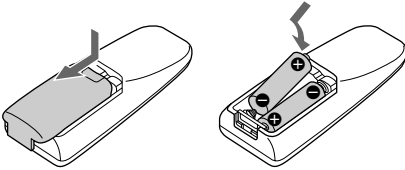

### Tip

With normal use, the batteries should last for about six months. When the remote no longer operates the system, replace both batteries with new ones.

### Note

If you do not use the remote for a long period of time, remove the batteries to avoid possible damage from battery leakage.

## When carrying this system

Do the following to protect the CD mechanism.

- 1 Press **FUNCTION** repeatedly until "CD" appears in the display.
- 2 Hold down **LOOP** and press **| / ⏻** so that "LOCK" appears in the display.

## Step 2: Setting the time

You must set the time before using the timer functions.

The clock is on a 24-hour system for the European model, and a 12-hour system for other models.

The 24-hour system model is used for illustration purposes.

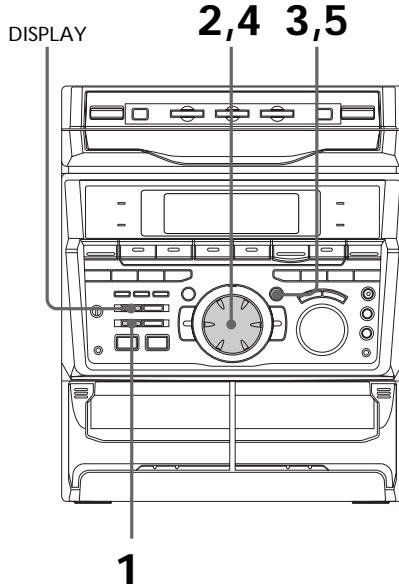

- 1 Press **CLOCK/TIMER SET**.  
The hour indication flashes.



- 2 Turn the jog dial to set the hour.

continued

## Step 2: Setting the time (continued)

- 3** Press ENTER/NEXT.  
The minute indication flashes.



- 4** Turn the jog dial to set the minute.

- 5** Press ENTER/NEXT.  
The clock starts working.

### Tip

If you've made a mistake, start over from step 1.

### To change the time

The previous explanation shows you how to set the time while the power is off. To change the time while the power is on, do the following:

- 1 Press CLOCK/TIMER SET.
- 2 Turn the jog dial to select SET CLOCK.
- 3 Press ENTER/NEXT.
- 4 Perform steps 2 through 5 above.

### Note

The clock settings are canceled when you disconnect the power cord or if a power failure occurs.

## Step 3: Presetting radio stations

You can preset the following number of stations:

- 2 band model: 20 for FM, 10 for AM.
- 3 band model: 20 for FM, 10 for MW, and 10 for SW, or 20 for FM, 10 for AM and 5 for UKV, depending on the model you purchased.

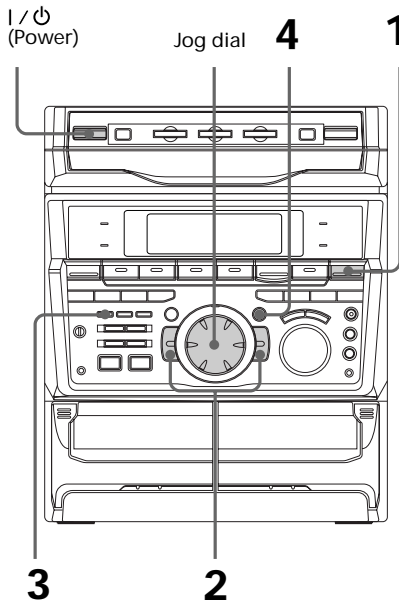



- 
- 1 Press TUNER/BAND repeatedly until the band you want appears in the display.

The bands you can receive vary depending on the model you purchased. Be sure to check which bands you can receive.

Every time you press this button, the band changes as follows:

2 band model:

FM ↔ AM

3 band model:

FM → MW → SW

or

FM → AM → UKV\*

\* "STEREO PLUS" is displayed when you select UKV.

- 
- 2 Press and hold + or - until the frequency indication starts to change, then release.

Scanning stops when the system tunes in a station. "TUNED" and "STEREO" (for a stereo program) appear.

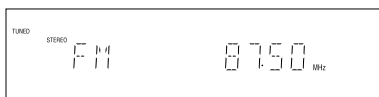

- 
- 3 Press TUNER MEMORY.

A preset number appears in the display. The stations are stored from preset number 1.

Preset number

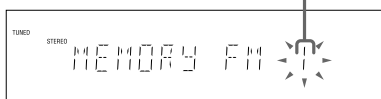

- 
- 4 Press ENTER/NEXT.

The station is stored.

- 
- 5 Repeat steps 1 to 4 to store other stations.
- 

## To tune in a station with a weak signal

Press + or - repeatedly in step 2 to tune in the station manually.

## To set another station to the exist preset number

Start over from step 1. After step 3, turn the jog dial to select the preset number you want to store the other station.

You can add a new preset number after the last preset number.

## To erase a preset station

- 1 Keep pressing TUNER MEMORY until a preset number appears in the display.

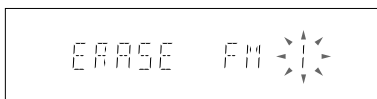

- 2 Turn the jog dial to select the preset number you want to erase. Select "ALL ERASE" when you want to erase all the preset stations.

- 3 Press ENTER/NEXT. "COMPLETE" appears.

When you erase a preset number, the preset number decreases by one and all preset numbers following the erased one are renumbered.

## To change the AM tuning interval (Except for the European and Middle Eastern models)

The AM tuning interval is factory set to 9 kHz (10 kHz in some areas). To change the AM tuning interval, tune in any AM station first, then turn off the power. While holding down the ENTER/NEXT button, turn the power back on. When you change the interval, AM preset stations will be erased. To reset the interval, repeat the same procedure.

### Tip

The preset stations are retained for half a day even if you unplug the power cord or if a power failure occurs.

---

# Saving the power in standby mode

(For MHC-RXD9/RXD80/RXD7/R770)

You can lower the power consumption to a minimum (Power Saving Mode) and save energy in the standby mode.

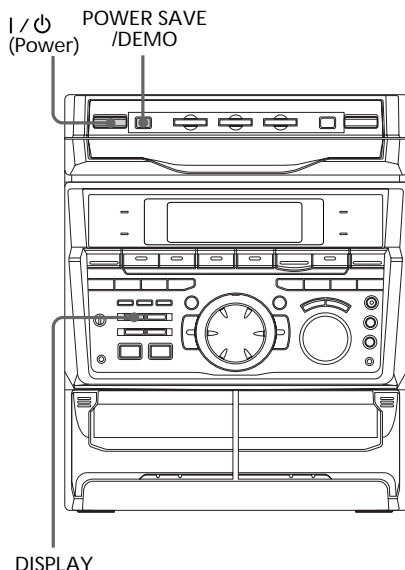

- 
- ➔ Press POWER SAVE/DEMO when the power is off.

The system switches to the Power Saving Mode and the clock display disappears.

The system is powering on/off by pressing I / ⏻.

---

## Tips

- Each time you press POWER SAVE/DEMO in the Power Saving Mode, the display switches between the Power Saving Mode and the demo mode.
- I / ⏻ indicator and timer indicator (when the timer is set) light up even in the Power Saving Mode.
- The timer works in the Power Saving Mode.

## Notes

- You cannot set the time in the Power Saving Mode.
- One Touch Play function does not work in the Power Saving Mode.

## To cancel the Power Saving Mode

Press DISPLAY.

The clock display appears.

## Playing a CD

### — Normal play

You can play up to three CDs in a row.

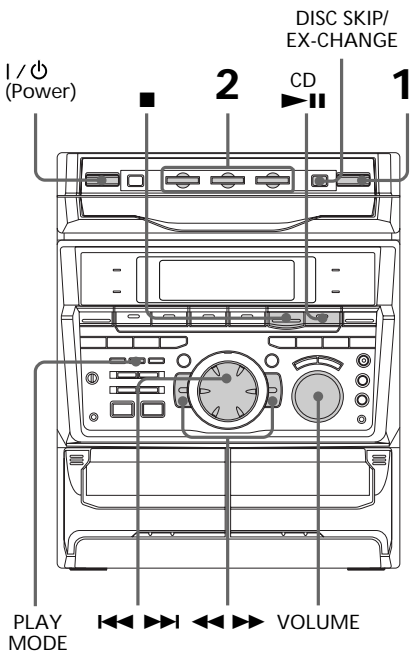

PLAY MODE    <<< >>>    <<< >>>    VOLUME

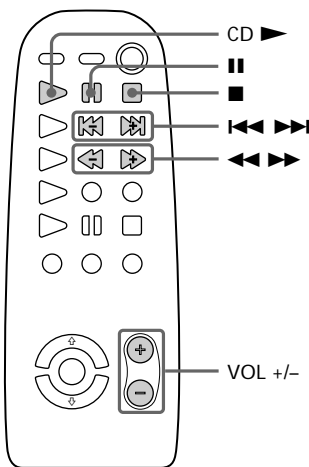

- 1 Press and place up to two CDs on the disc tray.

If a disc is not placed properly it will not be recognized.

With the label side up. When you play a single CD, place it on the inner circle of the tray.

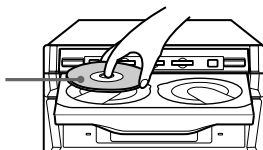

To insert a third disc, press DISC SKIP/ EX-CHANGE to rotate the disc tray.

- 2 Press one of the DISC 1~3 buttons.

The disc tray closes and play starts.

If you press CD (or CD on the remote) when the disc tray is closed, play starts from the CD loaded on the tray whose button is lit green.

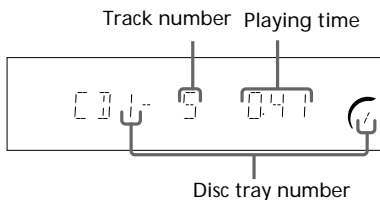

Disc tray number

continued

## Playing a CD (continued)

To	Do this
Stop play	Press ■.
Pause	Press CD ►   (   on the remote). Press again to resume play.
Select a track	During play or pause, turn the jog dial clockwise (to go forward) or counterclockwise (to go back) and release it when you reach the desired track. (Or press ►► (to go forward) or ◀◀ (to go back) on the remote.)
Find a point in a track	Press and hold down ►► or ◀◀ during play and release it at the desired point.
Select a CD in stop mode	Press a DISC 1~3 button or DISC SKIP/EX-CHANGE.
Play only the CD you have selected	Press PLAY MODE repeatedly until "1 DISC" appears.
Play all CDs	Press PLAY MODE repeatedly until "ALL DISCS" appears.
Remove the CD	Press ⏏.
Exchange other CDs while playing	Press DISC SKIP/EX-CHANGE.
Adjust the volume	Turn VOLUME (or press VOL +/- on the remote).

## Tips

- Pressing CD ►|| when the power is off automatically turns the power on and starts CD playback if there is a CD in the tray (One Touch Play). When the system is in the Power Saving Mode, the One Touch Play function does not work.
- You can switch from another source to the CD player and start playing a CD just by pressing CD ►|| or the DISC 1~3 buttons (Automatic Source Selection).
- If there is no CD in the player, "CD NO DISC" appears in the display.
- When a disc tray holding a CD is selected (or playing), the DISC 1~3 button for that tray lights green. When a disc tray holding a CD is not selected, the DISC 1~3 button for that tray lights orange. When all disc trays are empty, the DISC 1~3 buttons all light green.

# Recording a CD

## — CD Synchro Recording

The CD SYNC button lets you record from a CD to a tape easily. You can use TYPE I (normal) or TYPE II (CrO<sub>2</sub>) tapes. The recording level is adjusted automatically.

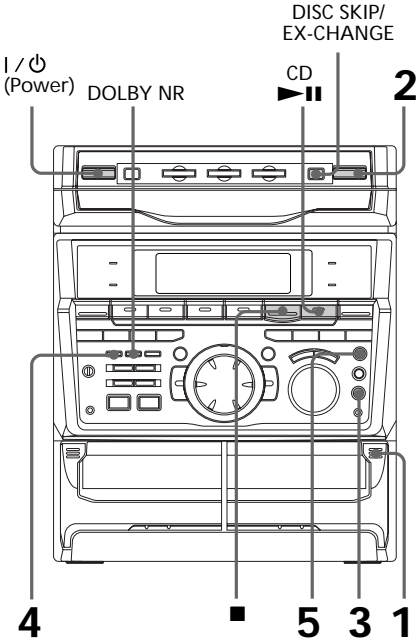

- 1 Press and insert a recordable tape into deck B.

With the side you want to record facing forward

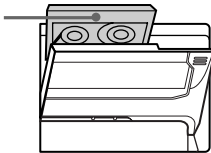

- 2 Press and place a CD.

Then press again to close the disc tray.

If the indicator for the tray you want to record is not lit green, press DISC SKIP/EX-CHANGE repeatedly so that it lights green.

With the label side up. When you play a single CD, place it on the inner circle of the tray.

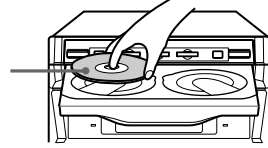

- 3 Press CD SYNC.

Deck B stands by for recording and the CD player stands by for playback. The indicator on TAPE B (for front side) lights up.

- 4 Press DIRECTION repeatedly to select to record on one side. Select (or RELAY) to record on both sides.

- 5 Press REC PAUSE/START. Recording starts.

### To stop recording

Press .

### Tips

- If you want to record from the reverse side, press TAPE B to light its indicator after pressing CD SYNC.
- When you record on both sides, be sure to start from the front side. If you start from the reverse side, recording stops at the end of the reverse side.
- When you want to reduce the hiss noise in low-level high-frequency signals, press DOLBY NR so that "DOLBY NR" appears after pressing CD SYNC.

### Note

You cannot listen to other sources while recording.

# Listening to the radio

## -- Preset Tuning

Preset radio stations in the tuner's memory first (see "Step 3: Presetting radio stations").

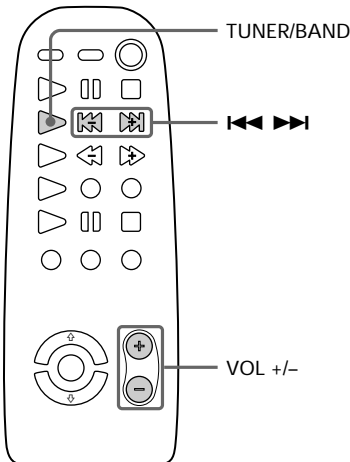
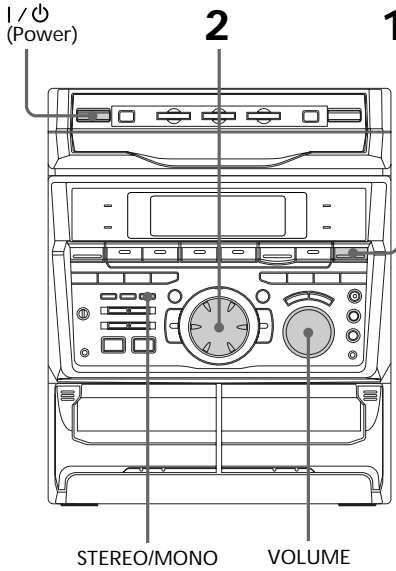

- 1 Press TUNER/BAND repeatedly until the band you want appears in the display.

The bands you can receive vary depending on the model you purchased. Be sure to check which bands you can receive.

Every time you press the button, the band changes as follows:

2 band model:

FM ↔ AM

3 band model:

FM → MW → SW



or

FM → AM → UKV\*



\* "STEREO PLUS" is displayed when you select UKV.

- 2 Turn the jog dial (or press ◀◀ or ▶▶ on the remote) to tune in the desired preset station.

Turn counter-clockwise (or press ◀◀ on the remote) for lower preset numbers.

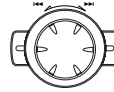

Turn clockwise (or press ▶▶ on the remote) for higher preset numbers.

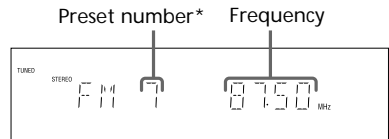

\* When only one station is preset, "ONE PRESET" appears in the display.

To	Do this
Turn off the radio	Press I / ⏻.
Adjust the volume	Turn VOLUME (or press VOL +/- on the remote).

## To listen to non-preset radio stations

Use manual or automatic tuning in step 2.  
For manual tuning, press + or - repeatedly.  
For automatic tuning, press and hold + or -.

### Tips

- Pressing TUNER/BAND when the power is off automatically turns the power on and tunes to the last received station (One Touch Play). When the system is in the Power Saving Mode, the One Touch Play function does not work.
- You can switch from another source to the radio just by pressing TUNER/BAND (Automatic Source Selection).
- When an FM program is noisy, press STEREO/MONO so that "MONO" appears in the display. There will be no stereo effect, but the reception will improve. Press the button again to restore the stereo effect.
- To improve broadcast reception, reorient the supplied antennas.

## Recording from the radio

You can record the radio program on a tape by calling up a preset station. You can use TYPE I (normal) or TYPE II (CrO<sub>2</sub>) tapes. The recording level is automatically adjusted.

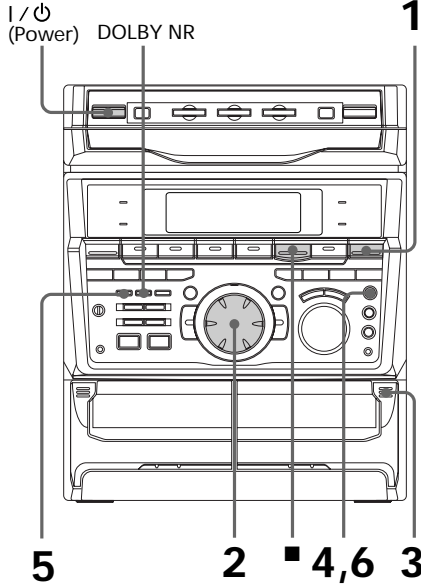

**1** Press TUNER/BAND to select the band you want.

**2** Turn the jog dial to tune in a preset station.

Turn counter-clockwise for lower preset numbers.

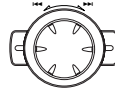

Turn clockwise for higher preset numbers.

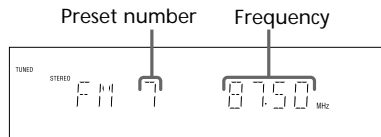

continued

## Recording from the radio (continued)

- Press and insert a recordable tape into deck B.

With the side you want to record facing forward

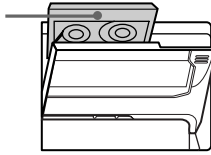

- Press REC PAUSE/START. Deck B stands by for recording.

- Press DIRECTION repeatedly to select to record on one side. Select (or RELAY) to record on both sides.

- Press REC PAUSE/START. Recording starts.

### To stop recording

Press .

#### Tips

- If you want to record from the reverse side, press TAPE B to light its indicator after pressing REC PAUSE/START in step 4.
- When you record on both sides, be sure to start from the front side. If you start from the reverse side, recording stops at the end of the reverse side.
- To record non-preset stations, use + and - in step 2 to tune in the desired station manually.
- When you want to reduce the hiss noise in low-level high-frequency signals, press DOLBY NR so that "DOLBY NR" appears after pressing REC PAUSE/START in step 4.
- If noise is heard while recording from the radio, move the respective antenna to reduce the noise.

## Playing a tape

You can use any type of tape, TYPE I (normal), TYPE II (CrO<sub>2</sub>) or TYPE IV (metal), since the deck automatically detects the tape type. You can also use the jog dial's AMS functions to quickly search for songs you want to hear. To select either deck A or B, press DECK A or DECK B on the remote.

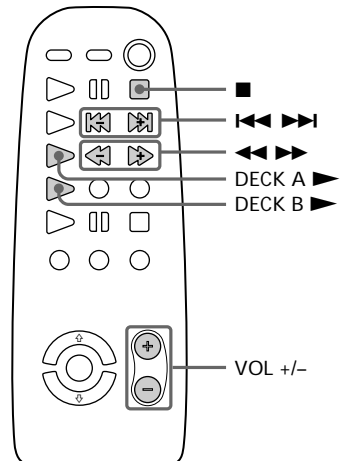
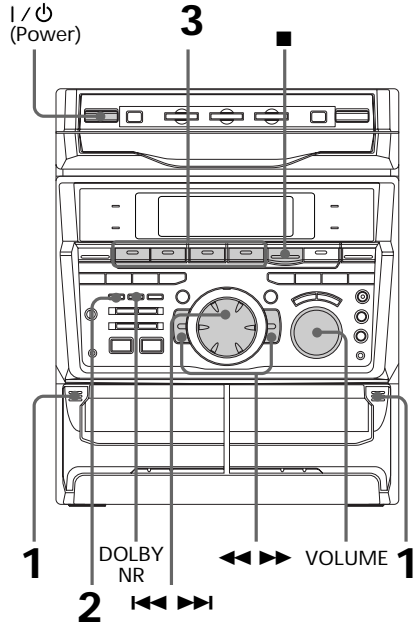







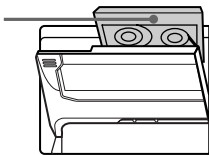

- 1 Press  and insert a recorded tape in deck A or B.

With the side you want to play facing forward



- 2 Press DIRECTION repeatedly to select  to play one side. Select \* to play both sides.







To play both decks in succession, select RELAY (relay play).\*\*

- 3 Press TAPE A (or TAPE B)  (DECK A (or DECK B)  on the remote).  
Press TAPE A (or TAPE B)  to play the reverse side. (Press DECK A (or DECK B)  again on the remote to play the reverse side.) The tape starts playing.





\* The deck stops automatically after repeating the sequence five times.

\*\* Relay play always follows the following sequence:





Deck A (front side), Deck A (reverse side),  
Deck B (front side), Deck B (reverse side).

To	Do this
Stop play	Press  .
Fast-forward	Press  or  .
Rewind	Press  or  .
Remove the cassette	Press  .
Adjust the volume	Turn VOLUME (or press VOL +/- on the remote).

## Tips

- Pressing TAPE A (or TAPE B)  or  when the power is off automatically turns the power on and starts tape playback if there is a tape in the deck (One Touch Play). When the system is in the Power Saving Mode, the One Touch Play function does not work.
- You can switch from another source to the tape deck just by pressing TAPE A (or TAPE B)  or  (Automatic Source Selection).
- When you want to reduce the hiss noise in low-level high-frequency signals, press DOLBY NR so that "DOLBY NR" appears.

## Searching for the beginning of a track (AMS\*)

During playback, turn the jog dial the same direction as the  or  indicator to go forward. Turn the opposite direction to go back. (Or press  or  on the remote.)

The search direction, + (forward) or - (back), and number of songs being skipped (1-9) appear in the display.

Example: searching forward 2 songs

TAPE A: : : : +2

\* AMS (Automatic Music Sensor)

## Notes

The AMS function may not operate correctly under the following circumstances:

- When the unrecorded space between songs is less than 4 seconds long.
- If completely different information is recorded on the left and right channels.
- When there are continuous sections of extremely low level or low frequency sound (like those of a baritone sax).
- When the unit is placed near a television. (In this case, we recommend moving the unit farther away from the television or turning off the television.)

---

# Recording from a tape

## — High-speed Dubbing

You can use TYPE I (normal) or TYPE II (CrO<sub>2</sub>) tapes. The recording level is automatically adjusted.

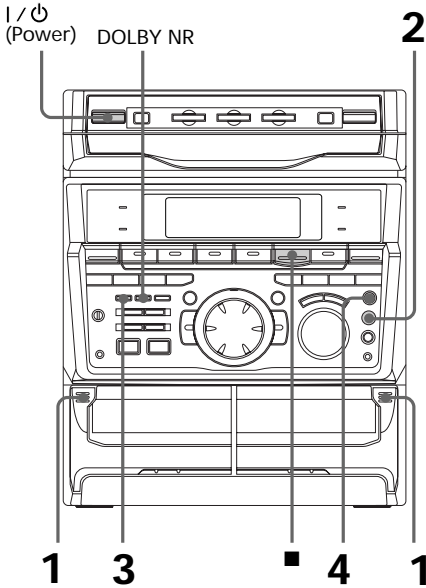

- 
- 1 Press and insert a recorded tape in deck A and a recordable tape in deck B.

With the side you want to play/record facing forward

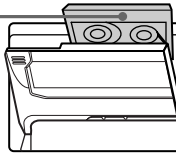

- 
- 2 Press HI-DUB.  
Deck B stands by for recording.

- 
- 3 Press DIRECTION repeatedly to select to record on one side. Select (or RELAY) to record on both sides.

- 
- 4 Press REC PAUSE/START.  
Dubbing starts.
- 

### To stop dubbing

Press .

### Tips

- When you dub on both sides, start recording from the front side. If you record from the reverse side, recording stops at the end of the reverse side.
- If you set DIRECTION to when the tapes you use have different lengths, the tape in each deck reverses independently. If you select RELAY, the tapes in both decks reverse together.
- You don't have to set DOLBY NR, since the tape in deck B is automatically recorded in the same state as the tape in deck A.

## Using the CD display

You can check the remaining time of the current track or that of the CD.

When a CD TEXT disc is loaded, you can check the information stored on the disc, such as the disc titles or artist names. When the unit detects CD TEXT discs, the "CD TEXT" indication appears in the display.

I / ⏻  
(Power)

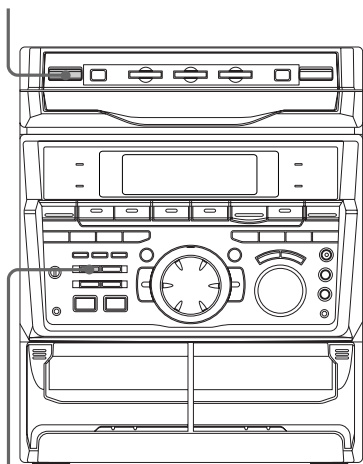

DISPLAY

➔ Press DISPLAY.

Each time you press the button during normal playback or in the stop mode, the display changes as follows:

### During normal playback

→ Playing time on the current track  
↓  
Remaining time on the current track  
↓  
Remaining time on current CD (1 DISC mode) or "--:--" display (ALL DISCS mode)  
↓  
Title name of the current track\*  
↓  
Clock display (for eight seconds)  
↓  
Effect (P FILE) name or "EFFECT ON (OFF)"

### In the stop mode

→ Title name of the CD\*  
↓  
Artist information\*  
↓  
Total number of tracks and total playing time  
↓  
Clock display (for eight seconds)  
↓  
Effect (P FILE) name or "EFFECT ON (OFF)"

\* With CD TEXT discs only (certain characters cannot be displayed). When the disc contains more than 20 tracks, CD TEXT is not displayed from track 21 on.

# Playing the CD tracks repeatedly

## — Repeat Play

This function lets you repeat a single CD or all CDs in normal play, Shuffle Play and Program Play.

I /   
(Power) PLAY MODE

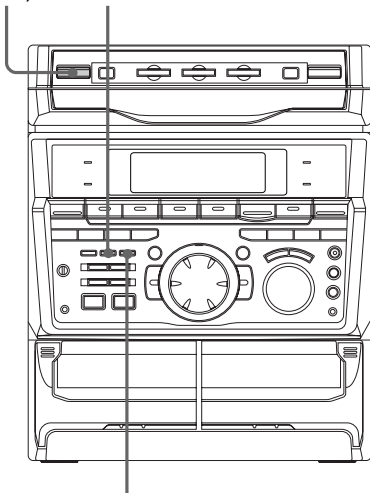

REPEAT

## To cancel Repeat Play

Press REPEAT so that “REPEAT” or “REPEAT 1” disappears from the display.

➔ Press REPEAT during playback until “REPEAT” appears in the display.

Repeat Play starts. Do the following procedure to change the repeat mode.

To repeat	Press
All the tracks on the current CD	PLAY MODE repeatedly until “1 DISC” appears in the display.
All the tracks on all CDs	PLAY MODE repeatedly until “ALL DISCS” appears in the display.
Only one track	REPEAT repeatedly until “REPEAT 1” appears in the display while playing the track you want to repeat.

---

# Playing the CD tracks in random order

## — Shuffle Play

You can play all the tracks on one CD or all CDs in random order.

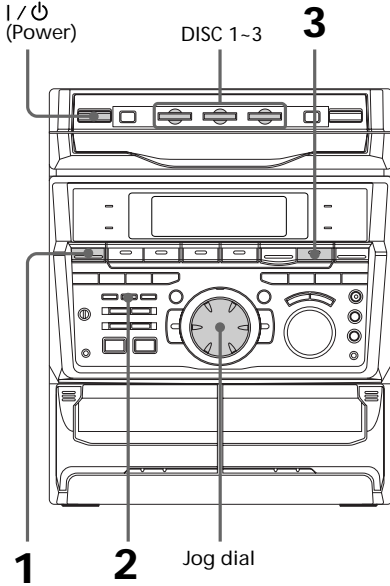

## To cancel Shuffle Play

Press PLAY MODE repeatedly until “SHUFFLE” or “PROGRAM” disappears from the display. The tracks continue playing in their original order.

## To select a desired CD

Press DISC 1~3.

## Tips

- You can start Shuffle Play during normal play by pressing PLAY MODE repeatedly to select “SHUFFLE”.
- To skip a track, turn the jog dial clockwise (or press ►► on the remote).

---

**1** Press FUNCTION repeatedly until “CD” appears in the display, then place a CD.

---

**2** Press PLAY MODE repeatedly until “1 DISC SHUFFLE” or “ALL DISCS SHUFFLE” appears in the display. “ALL DISCS” shuffles all the CDs in the player. “1 DISC” shuffles the CD whose DISC indicator is green.

---

**3** Press CD ►►. All the tracks play in random order.

---

# Programming the CD tracks

## — Program Play

You can make a program of up to 32 tracks from all the CDs in the order you want them to be played.

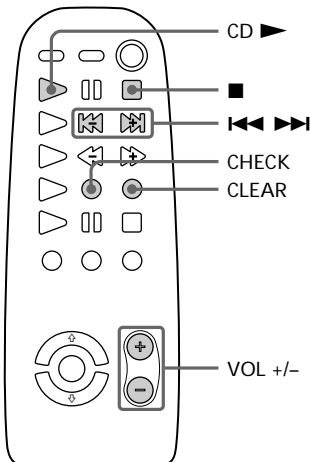
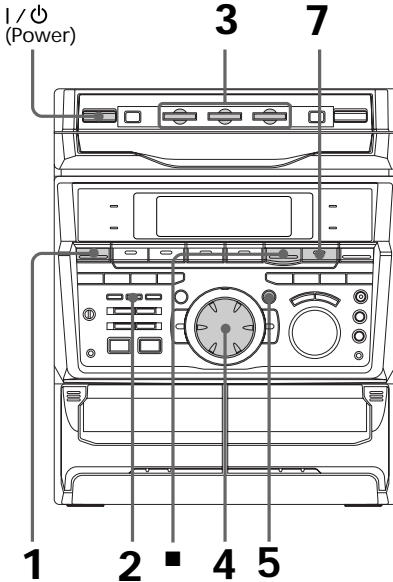

- 1** Press FUNCTION repeatedly until “CD” appears in the display, then place a CD.
- 2** Press PLAY MODE repeatedly until “PROGRAM” appears in the display.
- 3** Press one of the DISC 1~3 buttons to select a CD.
- 4** Turn the jog dial until the desired track appears in the display.

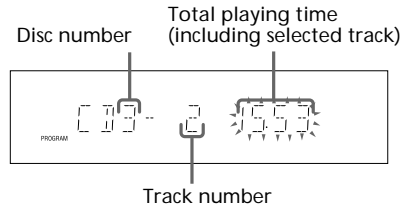

- 5** Press ENTER/NEXT.  
The track is programmed. The program step number appears, followed by the total playing time.
- 6** To program additional tracks, repeat steps 3 to 5.  
Skip step 3 to select tracks from the same disc.
- 7** Press CD ►||.  
All the tracks play in the order you selected.

## To cancel Program Play

Press PLAY MODE repeatedly until "PROGRAM" or "SHUFFLE" disappears from the display.

To	Press
Check the program	CHECK on the remote repeatedly. After the last track, "CHECK END" appears.
Clear a track from the end	CLEAR on the remote in stop mode.
Clear a specific track	CHECK on the remote repeatedly until the number of the track to be erased lights up, then press CLEAR.
Add a track to the program	1 Select the disc tray with a DISC 1-3 button. 2 Select the track by turning the jog dial. 3 Press ENTER/NEXT.
Clear the entire program	■ once in stop mode or twice while playing.

## Tips

- The program you made remains in the CD player even after it has been played back. Press CD ►|| to play the same program again.
- If "--:--" appears instead of the total playing time during programming, this means:
  - you have programmed a track number which exceeds 20.
  - the total playing time has exceeded 100 minutes.

## Playing CDs without interruption

### -- Non-Stop Play

You can play CDs without pausing between tracks.

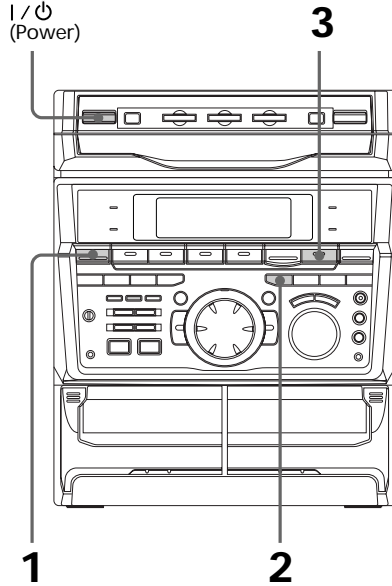

**1** Press FUNCTION repeatedly until "CD" appears in the display, then place a CD.

**2** Press NON-STOP to light the indicator. "NON-STOP PLAY" appears in the display.

**3** Press CD ►||.

### To cancel Non-Stop Play

Press NON-STOP so that the indicator goes out and "NON-STOP OFF" appears in the display.

## Recording on a tape manually

You can record from CD, tape, or radio as you like. For example, you can record just the songs you want or record from the middle of the tape. The recording level is adjusted automatically.

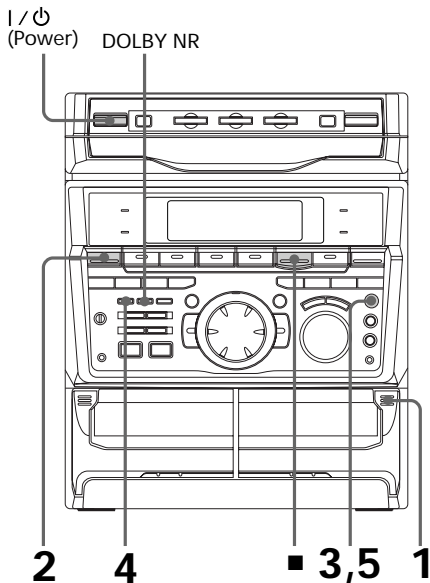

- 1** Insert a recordable tape into deck B.
- 2** Press FUNCTION repeatedly until the source you want to record (e.g., CD) appears.
- 3** Press REC PAUSE/START.  
Deck B stands by for recording. The indicator on TAPE B ► (for front side) lights up.

- 4** Press DIRECTION repeatedly to select ◀▶ to record on one side. Select ↔ (or RELAY) to record on both sides.

- 5** Press REC PAUSE/START.  
Recording starts.

- 6** Start playing the source to be recorded.

To	Press
Stop recording	■
Pause recording	REC PAUSE/START.

### Tips

- If you want to record from the reverse side, press TAPE B ◀ to light its indicator after pressing REC PAUSE/START in step 3.
- When you want to reduce the hiss noise in low-level high-frequency signals, press DOLBY NR so that "DOLBY NR" appears after pressing REC PAUSE/START in step 3.
- When recording from a CD, you can use the jog dial to select tracks during rec pause mode (after pressing REC PAUSE/START in step 3 and before pressing again in step 5).



# Recording a CD by specifying track order

## — Program Edit

You can record tracks from all the CDs in the order you want. When programming, make sure the playing times for each side do not exceed the length of one side of the tape.

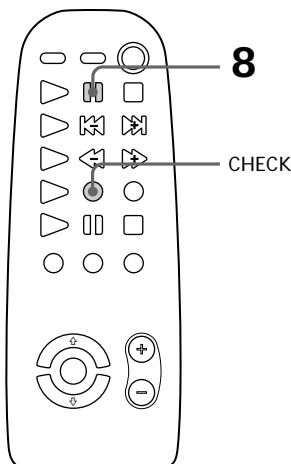
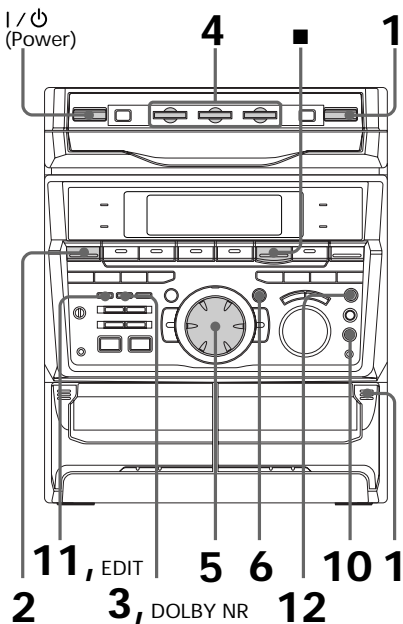

- 1 Place a CD and insert a recordable tape into deck B.
  - 2 Press FUNCTION repeatedly until "CD" appears in the display.
  - 3 Press PLAY MODE repeatedly until "PROGRAM" appears in the display.
  - 4 Press one of the DISC 1-3 buttons to select a CD.
  - 5 Turn the jog dial until the desired track appears in the display.
- 
- A diagram of the display showing the following information: 'PROGRAM', 'Disc number', 'Track number', and 'Total playing time (including selected track)'. The display shows 'PROGRAM' on the left, 'Disc number' in the middle, 'Track number' on the right, and 'Total playing time (including selected track)' on the far right.

- 6 Press ENTER/NEXT.  
The track is programmed. The program step number appears, followed by the total playing time.
- 7 To program additional tracks to be recorded on side A, repeat steps 4 to 6.  
Skip step 4 to select tracks from the same disc.
- 8 Press **||** on the remote to insert a pause at the end of side A.  
"P" appears in the display and the total playing time resets to "0.00" in the display.

continued

## **Recording a CD by specifying track order (continued)**

---

**9** Repeat steps 5 and 6 for tracks from the same disc or steps 4 to 6 for tracks from another disc to program the remaining tracks to be recorded on side B.

---

**10** Press CD SYNC.  
Deck B stands by for recording and the CD player stands by for playback. The indicator on TAPE B ► (for front side) lights up.

---

**11** Press DIRECTION repeatedly to select ⇄ to record on one side. Select ⇄⇄ (or RELAY) to record on both sides.

---

**12** Press REC PAUSE/START.  
Recording starts.

---

### **To stop recording**

Press ■.

### **To check the order**

Press CHECK on the remote repeatedly. After the last track, "CHECK END" appears.

### **To cancel Program Edit**

Press PLAY MODE repeatedly until "PROGRAM" or "SHUFFLE" disappears from the display.

### **Tip**

When you want to reduce the hiss noise in low-level high-frequency signals, press DOLBY NR so that "DOLBY NR" appears after pressing CD SYNC.

## **Selecting tape length automatically**

### **—Tape Select Edit**

You can check the most suitable tape length for recording a CD. Note that you cannot use Tape Select Edit for discs containing over 20 tracks.

---

**1** Insert a CD.

---

**2** Press FUNCTION repeatedly until "CD" appears in the display.

---

**3** Press EDIT once, so that "EDIT" flashes.  
The required tape length for the currently selected CD appears, followed by the total playing time for side A and side B respectively.

---

### **Note**

You cannot use this function after programming. In order to use this function, you must first cancel the program by pressing PLAY MODE repeatedly until "PROGRAM" or "SHUFFLE" disappears from the display.

## Looping part of a CD

### — Loop

With the loop function, you can repeat part of a CD during playback. This lets you create original recordings.

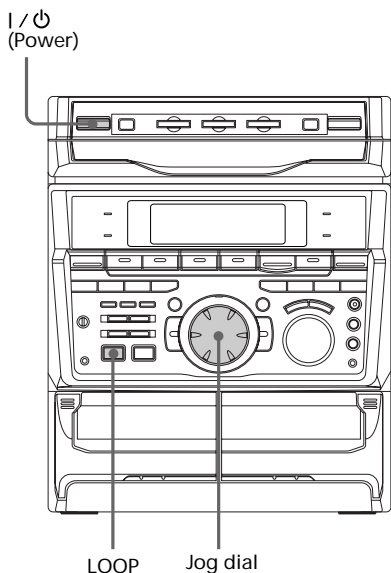

➔ Press and hold LOOP during playback at the point you want to start the Loop function, and release to resume normal play.

### To adjust the loop length

Turn the jog dial while holding LOOP (or press SELECT  $\uparrow$  or  $\downarrow$  while holding LOOP on the remote) to select different loop lengths (LOOP 1~20).

## Flashing part of a CD

### — Flash

With the flash function, you can “flash” the CD sound during playback. This lets you create original recordings.

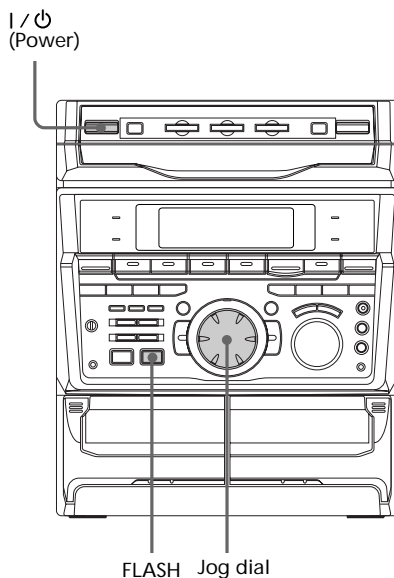

➔ Press and hold FLASH during playback at the point you want to start the Flash function, and release to resume normal play.

### To adjust the flash length

Turn the jog dial while holding FLASH (or press SELECT  $\uparrow$  or  $\downarrow$  while holding FLASH on the remote) to select different flash lengths (FLASH 1~20).

### To use LOOP and FLASH together

Press and hold both LOOP and FLASH at the same time.

### Notes

- The loop and flash length cannot be adjusted during this operation. Adjust the loop and flash lengths independently beforehand if necessary.
- To record the flash effect, use the analog (MD OUT) connections or this unit's tape deck.

## Adjusting the sound

You can reinforce the bass, create a more powerful sound, and listen with headphones.

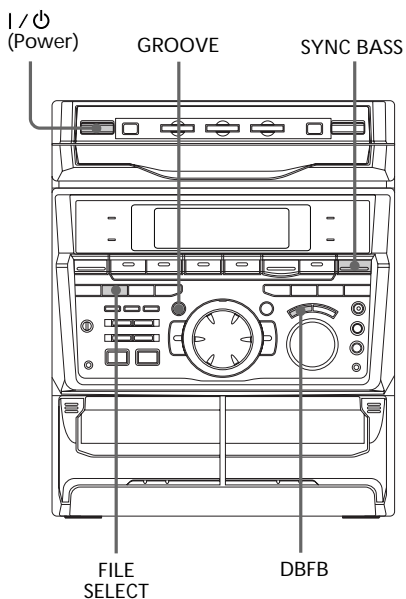

### To reinforce bass (DBFB)

Press DBFB\*.

Every time you press the button, the display changes as follows:

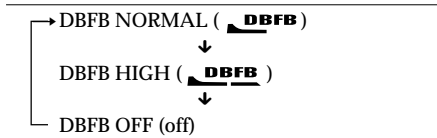

\* DBFB = Dynamic Bass Feedback

### For the most suitable bass sound (SYNC BASS)

Press SYNC BASS.

The bass frequencies of the music you are listening to are measured and those areas with heavy bass tones are effectively reinforced. The indicator SYNC BASS H or SYNC BASS L lights up according to the areas with heavy bass tones. Press SYNC BASS again to return to the previous level.

### For a powerful sound (GROOVE)

Press GROOVE. The volume switches to power mode, DBFB is automatically set to full strength, the equalizer curve changes, and GROOVE button lights up. Press GROOVE again to return to the previous volume.

### Notes

- With some songs, the music will sound distorted when you use the DBFB system with the sound effect if the bass is too strong. Set the DBFB to " **DBFB**" or "OFF", or cancel the sound effect (see page 30).
- Cancelling GROOVE sets DBFB to " **DBFB**" and flattens the equalizer curve. To cancel the DBFB level, press DBFB until the indication disappears.

### To listen through the headphones

Connect the headphones to PHONES jack. No sound will come from the speakers.

# Selecting the audio emphasis

The audio emphasis menu lets you select the sound characteristic according to the sound you are listening to.

Besides, you can also enjoy audio emphasis using the synchronized equalizer function. When using this function, the system switches the equalizer according to the genre automatically.

# Selecting the effect from the music menu

MHC-GRX9900/GRX70/GRX70J/RXD9/RXD80

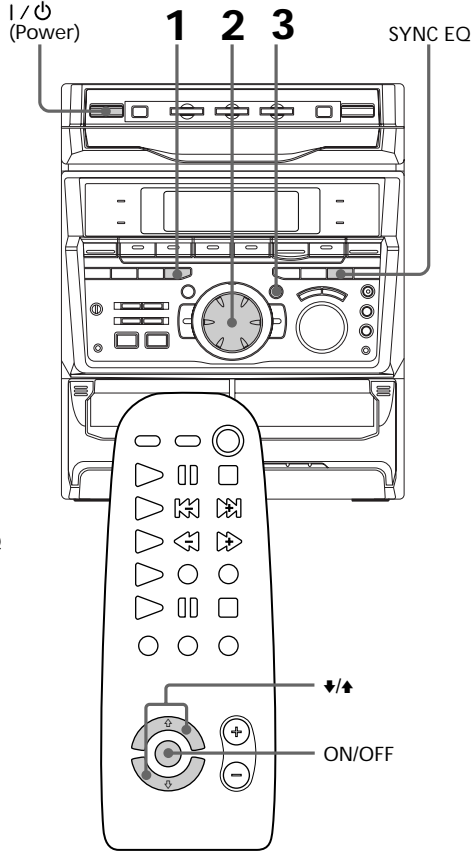
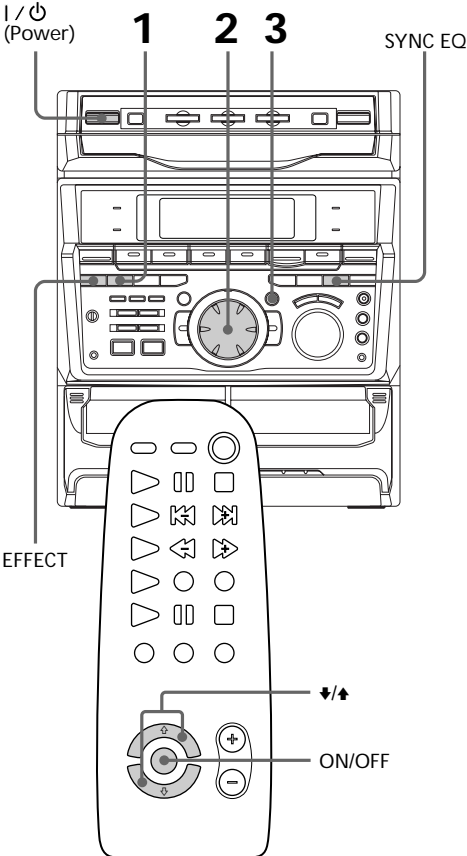

---

**1** Press FILE SELECT.  
The last effect chosen appears in the display.

---

**2** Use the jog dial to select the preset you desire.  
The preset name appears in the display. See the chart "Music menu options".

---

**3** Press ENTER/NEXT.

---

continued

## Selecting the audio emphasis (continued)

### To cancel the effect

Press EFFECT (for MHC-GRX9900/GRX70/GRX70J/RXD9/RXD80 only) or ON/OFF on the remote repeatedly so that “EFFECT OFF” appears in the display.

### Music menu options

“**SURROUND**” appears if you select an effect with surround effects.

#### For MHC-GRX9900/GRX70/GRX70J/ RXD9/RXD80

Effect	For
ROCK	Standard music sources
POP	
JAZZ	
DANCE	
SOUL	
ACTION	Soundtracks and special listening situations
ROMANCE	
SF	
DRAMA	
SPORTS	
SHOOTING	Video games
RACING	
RPG	
BATTLE	
ADVENTURE	
P FILE 1~5	

\* The personal file function lets you store your own effects (see “Making a personal audio emphasis file” on page 33).

#### For MHC-GRX50/RXD7/R770

Effect	For
ROCK	Standard music sources
POP	
JAZZ	
DANCE	
SOUL	
ACTION	Soundtracks and special listening situations
ROMANCE	
DRAMA	
SPORTS	
FLAT	Listening without effects

## Using the synchronized equalizer

You can set the audio emphasis to change automatically according to the beat and tempo at the music.

### ➔ Press SYNC EQ.

The indicator blinks while measuring the beat and tempo of the source. Once measured, the indicator lights up in the display.

SYNC EQ classifies the music as follows:

Beat Density	LO (Low)
	HI (High)
Beat Strength	SMOOTH
	MEDIUM
	STRONG

### To cancel the synchronized equalizer

Press SYNC EQ again. The indicator turns off.

The synchronized equalizer is canceled also when:

- cancel the effect
- select the effect from the music menu
- select the surround effect
- adjust the graphic equalizer
- sing along (karaoke).

### Notes

- SYNC EQ does not work in KARAOKE mode.
- For MHC-GRX9900/GRX70/GRX70J/RXD9/RXD80, P FILE MEMORY does not work in SYNC EQ mode.
- The names of classification are not related with the genre of the music source.

---

## Changing the spectrum analyzer display

You can enjoy changing the display while listening to the music.

| / ⏻  
(Power)

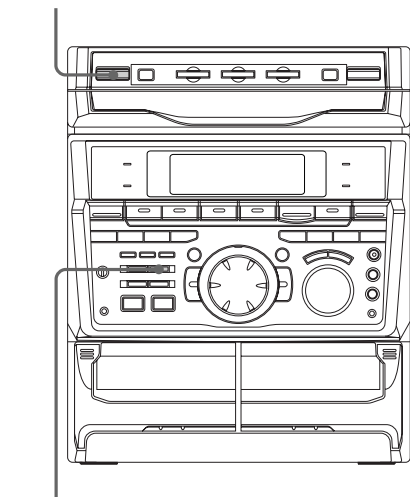

SPECTRUM ANALYZER

---

➔ Press SPECTRUM ANALYZER.

Every time you press the button, the display changes as follows:

IMAGE PATTERN



NORMAL PATTERN

---

---

## Selecting surround effects

You can enjoy surround effects.

| / ⏻  
(Power)

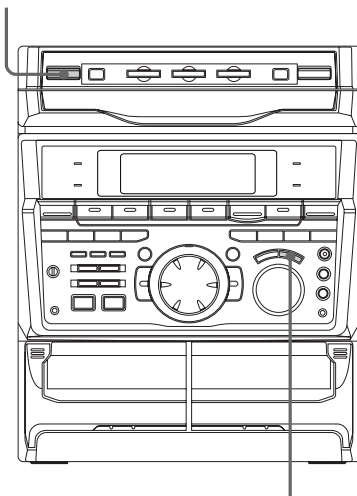

SURROUND

---

➔ Press SURROUND repeatedly to select the surround effect you desire.

Every time you press the button, the display changes as follows:

SURROUND ON ( **SURROUND** )



SURROUND OFF (off)

---

### Tip

For MHC-GRX9900/GRX70/GRX70J/RXD9/RXD80, if you want to memorize the effect, store it into a personal file (see "Making a personal audio emphasis file").

### Note

When you choose other sound effects, the surround effects will be canceled.

# Adjusting the graphic equalizer

(MHC-GRX9900/GRX70/GRX70J/RXD9/  
RXD80 only)

You can adjust the sound by raising or lowering the levels of specific frequency ranges.

Before operation, first select the audio emphasis you want for your basic sound.

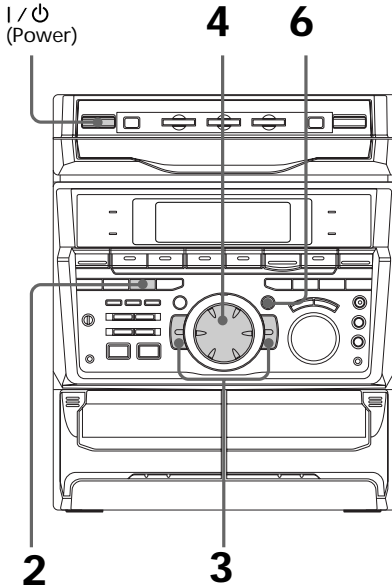

**1** Select the audio emphasis you want for your basic sound (see “Selecting the audio emphasis” on page 29).

**2** Press GEQ CONTROL.

**3** Press + or - repeatedly to select a frequency band.

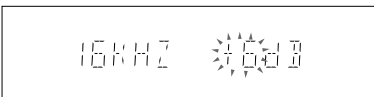

**4** Turn the jog dial to adjust level.

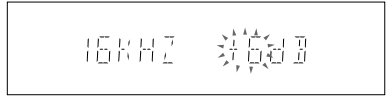

**5** Repeat steps 3 and 4.

**6** Press ENTER/NEXT when finished.

## Note

If you choose another menu audio emphasis (other than “EFFECT OFF”), the adjusted sound effect is lost. To retain the adjusted sound effect for future use, store it in a personal file. (See “Making a personal audio emphasis file”.)



---

# Making a personal audio emphasis file

## — Personal file

(MHC-GRX9900/GRX70/GRX70J/RXD9/RXD80 only)

You can create a personal file of audio patterns (surround effect and graphic equalizer) and store them in the memory of the unit. Later, call up an audio pattern to play a favorite tape, CD, or radio program. Create up to five audio files.

Before operation, first select the audio emphasis you want for your basic sound.

I / ⏻  
(Power)

2 3 4

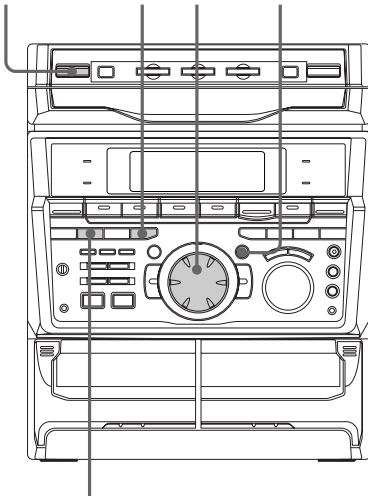

FILE SELECT

---

**1** Obtain the sound effect you want by using the graphic equalizer and surround effect.

---

**2** Press P FILE MEMORY.

The personal file number appears in the display.

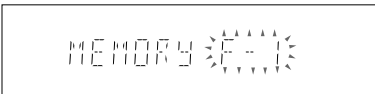

---

**3** Use the jog dial to select the file number (P FILE 1~5) where you want to store the sound effect.

---

**4** Press ENTER/NEXT.

The adjusted sound effects are stored under the selected file number. The settings previously stored at this memory location are erased and replaced by the new settings.

---

### To call up the personal file

**1** Press FILE SELECT.

**2** Use the jog dial to select the personal file you desire.

**3** Press ENTER/NEXT.

# Using the Radio Data System (RDS)

(For European model only)

## What is the Radio Data System?

Radio Data System (RDS) is a broadcasting service that allows radio stations to send additional information along with the regular program signal. This tuner offers convenient RDS features like station name display and location of stations by program type. RDS is available only on FM stations.\*

### Note

RDS may not work properly if the station you are tuned to is not transmitting the RDS signal properly or if the signal strength is weak.

\* Not all FM stations provide RDS service, nor do they provide the same type of services. If you are not familiar with the RDS system, check with your local radio stations for details on RDS services in your area.

## Receiving RDS broadcasts

➔ Simply select a station from the FM band. When you tune in a station that provides RDS services, the station name appears in the display.

## To check the RDS information

Each time you press DISPLAY, the display changes as follows:

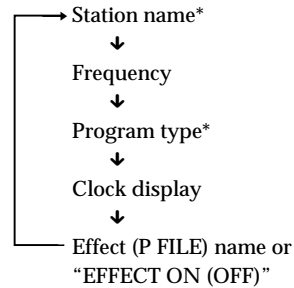

\* If the RDS broadcast is not received, the station name and program type may not appear in the display.

## Locating a station by program type (PTY)

You can locate a station you want by selecting a program type. The unit tunes in the type of programs currently being broadcast from the RDS stations stored in the tuner's preset memory.

| / ⏻  
(Power)

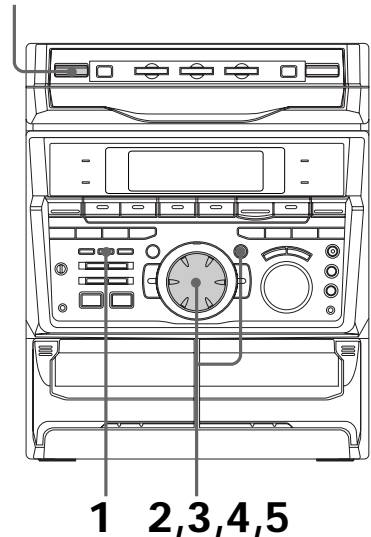

- 1** Press **PTY** while listening to the radio.
- 2** Turn jog dial to select the program type you want. See the “List of program types” section below.
- 3** Press **ENTER/NEXT**.  
The unit starts searching the preset RDS stations (“SEARCH” and the selected program type are shown alternately in the display).  
When the tuner receives a program, the preset station number flashes.
- 4** Turn jog dial to display the preset station number you desire.
- 5** Press **ENTER/NEXT** while the preset station number is flashing.

**To cancel PTY search**

Press **PTY** again.

**List of program types (PTY)**

- NEWS**  
News programs.
- AFFAIRS**  
Topical programs that expand on current news.
- INFORMATION**  
Programs about consumer affairs, medical advice.
- SPORT**  
Sports programs.
- EDUCATION**  
Educational programs, such as “how-to” programs and advice.
- DRAMA**  
Radio plays and serials.
- CULTURE**  
Programs about national or regional culture, language, and social concerns.

- SCIENCE**  
Programs about the natural sciences.
- VARIED**  
Programs containing celebrity interviews, panel games, and comedy.
- POP**  
Popular music programs.
- ROCK**  
Rock music programs.
- EASY MUSIC**  
Easy listening (middle of the road music).
- L. CLASSICAL**  
Classical music, such as instrumental, vocal, and choral works.
- S. CLASSICAL**  
Performances of major orchestras, chamber music, opera, etc.
- OTHER MUSIC**  
Music, such as rhythm and blues and reggae.
- WEATHER**  
Weather information.
- FINANCE**  
Stock market reports and trading, etc.
- CHILDREN**  
Programs for young.
- SOCIAL**  
Programs about people and the things that affect them.
- RELIGION**  
Programs of religious contents.
- PHONE IN**  
Programs where members of the public express their views by phone or in a public forum.
- TRAVEL**  
Programs about travel. Not for announcements that are located TP/TA.
- LEISURE**  
Programs on recreational activities such as gardening, fishing, cooking, etc.

continued

## Using the Radio Data System (RDS) (continued)

### JAZZ

Jazz programs.

### COUNTRY

Country music programs.

### NATION

Programs featuring the popular music of the country or region.

### OLDIES

Programs featuring oldies music.

### FOLK

Folk Music Programs.

### DOCUMENTARY

Investigative features.

### ALARM TEST

Test signal for emergency broadcasts.

### ALARM-ALARM

Emergency broadcasts.

### NONE

Any programming not defined above.

### Notes

"NO PTY" appears when the program type you selected is not currently being broadcast.

## Singing along: Karaoke

You can sing along with any stereo CD or tape by turning down the singer's voice. You need to connect an optional microphone.

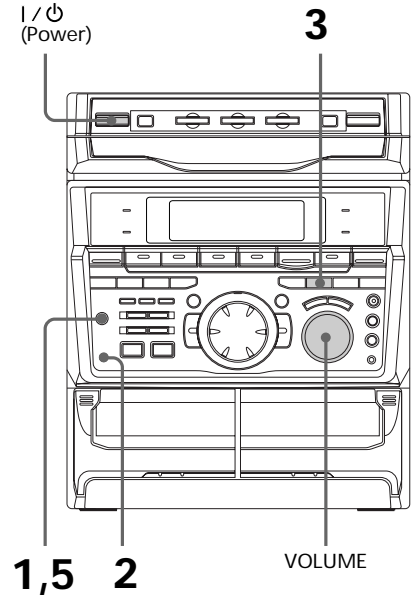

**1** Turn MIC LEVEL to 0 to turn down the microphone control level.

**2** Connect an optional microphone to MIX MIC.

**3** Press KARAOKE PON/MPX repeatedly to obtain the karaoke effect you desire. Every time you press the button, the display changes as follows:

KARAOKE PON → MPX R → MPX L  
↑ EFFECT OFF (ON)\* ↓

\* When an audio emphasis is selected, the effect name appears.

The  indicator appears in the display when a karaoke mode is activated. To sing karaoke with decreasing the vocal level of a CD, select "KARAOKE PON". To sing karaoke of multiplex CD or tape, select "MPX R" or "MPX L".

---

**4** Start playing the music and adjust the volume.

---

**5** Adjust the microphone volume by turning MIC LEVEL.

---

### When you are done

Turn MIC LEVEL to 0 and disconnect the microphone from MIX MIC, then press KARAOKE PON/MPX repeatedly so that "🎤" disappears.

### Note

With some songs, vocals may not be cancelled when you select "KARAOKE PON".

## Adjusting the microphone echo

(For Middle Eastern models only)

I / ⏻  
(Power)

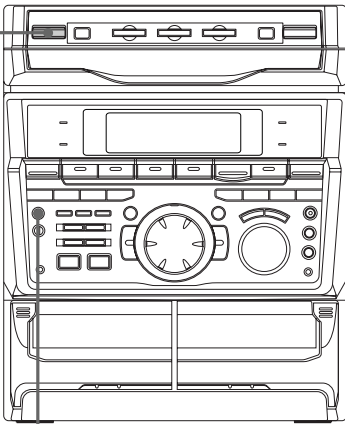

ECHO LEVEL

➔ Turn ECHO LEVEL to adjust the echo effect.

---

### To cancel the echoing

Turn ECHO LEVEL to 0.

---

## Mixing and recording sounds

I / ⏻  
(Power)

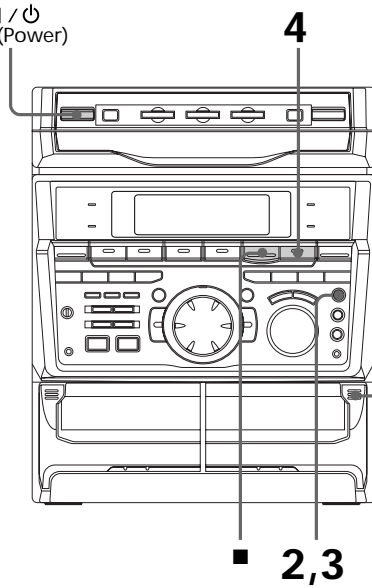

---

**1** Do the procedures for singing along (steps 1 to 5 on page 36, 37). Then, insert a tape in deck B.

---

**2** Press REC PAUSE/START.

---

**3** Press REC PAUSE/START again.  
Recording starts.

---

**4** Press CD ▶|| to start playing the CD player (or TAPE A ▶ for tape deck A).  
Playback starts. Start singing along with the music.

---

continued

## Singing along: Karaoke (continued)

### To stop recording

Press ■.

### Tips

- If acoustic feedback (howling) occurs, move the microphone away from the speakers or change the direction of the microphone.
- If you want to record your voice through the microphone only, you can do so by selecting the CD function and not playing a CD.
- When high level sound signals are input, the unit automatically adjusts the recording level to prevent distortion of the recorded sound signal (Auto Level Control function).

### Notes

- If you press EFFECT (or ON/OFF on the remote) or recall a sound effect, the karaoke mode is cancelled.
- The instrumental sound may be reduced as well as the singer's voice when the sound is recorded in monaural.
- The singer's voice may not be reduced when:
  - only a few instruments are playing.
  - a duet is being played.
  - the source has strong echoes or chorus.
  - the singer's voice deviates from the center.
  - the voice on the source is singing in high soprano or tenor.

---

## Falling asleep to music

### — Sleep Timer

You can let the system turn off at the preset time, so you can sleep to the music. You can preset the time to be turned off by 10 minutes.

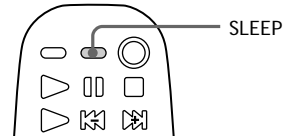

---

### ➔ Press SLEEP.

Every time you press the button, the minute display (the turn-off time) changes as follows:

AUTO → 90min → 80min → 70min  
→ ... → 10min → OFF → AUTO ...

---

### When you choose "AUTO"

The power turns off when the current CD or tape finishes playback (for up to 100 minutes).

### To check the remaining time

Press SLEEP once.

### To change the time to turn off

Select the time you want by pressing SLEEP.

### To cancel the Sleep Timer function

Press SLEEP repeatedly until "SLEEP OFF" appears.

# Waking up to music

## — Wake-up Timer

You can wake up to music at a preset time every day. Make sure you have set the clock (see “Step 2: Setting the time”).

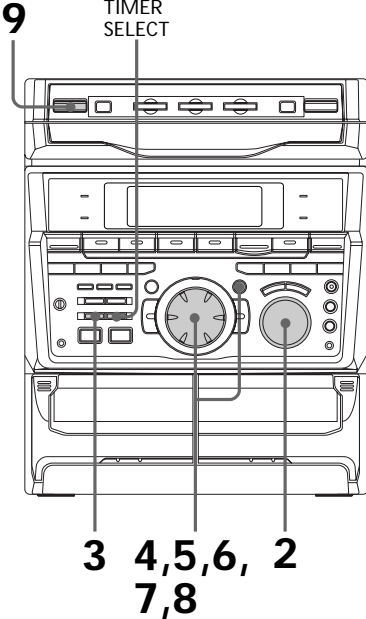

**1** Prepare the music source you want to play.

- CD: Insert a CD. To start from a specific track, make a program (see “Programming the CD tracks” on page 22).
- Tape: Insert a tape with the side you want to play facing forward.
- Radio: Tune in the preset station you want (see “Step 3: Presetting radio stations” on page 8).

**2** Adjust the volume.

**3** Press CLOCK/TIMER SET.  
“SET (DAILY 1)” appears.

**4** Turn jog dial to select “DAILY 1 (or 2)”, then press ENTER/NEXT.  
“ON” appears and the hour digits flash in the display.



**5** Set the time to start playback.  
Turn jog dial to set the hour, then press ENTER/NEXT.  
The minute indication starts flashing.



Turn jog dial to set the minute, then press ENTER/NEXT.  
The hour indication flashes again.

**6** Set the time to stop playback following the above procedure.

**7** Turn jog dial until the music source you want appears.

The indications change as follows:

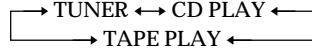

**8** Press ENTER/NEXT.  
The type of timer (DAILY 1 or DAILY 2), followed by the start time, stop time and the music source, appears, then the original display appears.

**9** Turn off the power.

continued

## Waking up to music (continued)

### To check the setting

Press **TIMER SELECT** and turn the jog dial to select the respective mode (**DAILY 1** or **DAILY 2**), then press **ENTER/NEXT**.

To change the setting, start over from step 1.

### To cancel the timer operation

Press **TIMER SELECT** and turn the jog dial to select “**TIMER OFF**”, then press **ENTER/NEXT**.

### Tip

The power turns on 15 seconds before the preset time.

## Timer-recording radio programs

To timer-record, you must preset the radio station (see “Step 3: Presetting radio stations”) and set the clock (see “Step 2: Setting the time”) beforehand.

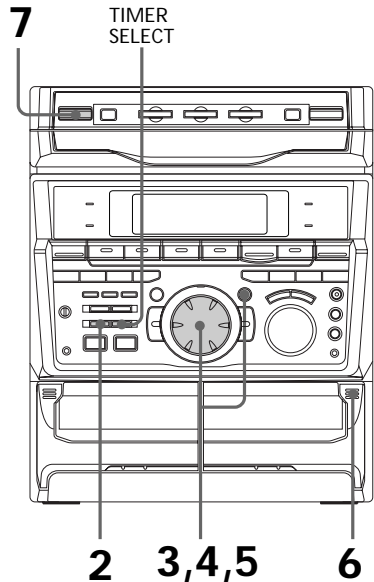

- 1** Tune in the preset radio station (see “Listening to the radio” on page 14).
- 2** Press **CLOCK/TIMER SET**.  
“**SET (DAILY 1)**” appears.
- 3** Turn jog dial to select “**REC**”, then press **ENTER/NEXT**.  
“**ON**” appears and the hour digits flash in the display.





- 4** Set the time to start recording.  
Turn the jog dial to set the hour, then press ENTER/NEXT.  
The minute indication starts flashing.



Turn the jog dial to set the minute, then press ENTER/NEXT.  
The hour indication flashes again.

- 5** Set the time to stop recording following the above procedure.  
The start time appears, followed by the stop time, the preset radio station to be recorded (e.g., "TUNER FM 5"), then the original display appears.

- 6** Insert a recordable tape.

- 7** Turn off the power.  
When the recording starts, the volume level is set to the minimum.

### To check the setting

Press TIMER SELECT and turn the jog dial to select "REC", then press ENTER/NEXT.

To change the setting, start over from step 1.

### To cancel the timer operation

Press TIMER SELECT and turn the jog dial to select "TIMER OFF", then press ENTER/NEXT.

### Note

If the power is on at the preset time, the recording will not be made.

## Connecting audio components

Select one of the following connections, depending on the equipment to be connected and method of connecting. Refer to the instructions of each component.

### Connecting an MD deck for digital recording

You can record from CD into the MD deck digitally by connecting an optical cable.

To the DIGITAL IN jack of the MD deck

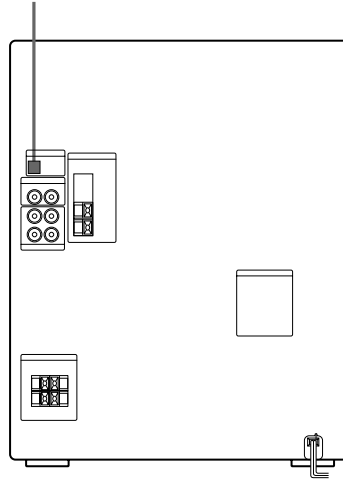

continued

## Connecting audio components (continued)

### Connecting an MD deck for analog recording

Make sure to match the color of the plugs and the connectors. To listen to the sound of the connected MD deck, press FUNCTION repeatedly until "MD" appears.

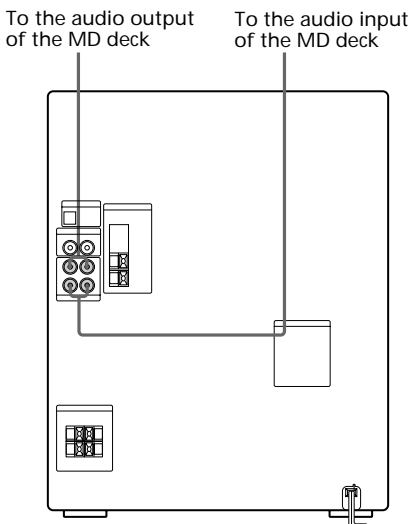

#### Tip

When you connect a Sony MD deck, you can use the MD ►, ||, and ■ buttons on this unit's remote to perform play, pause, and stop operations.

### Connecting a super woofer speaker

(except for MHC-RXD9 (European model)/RXD7 (European model)/R770)

You can connect an optional super woofer speaker.

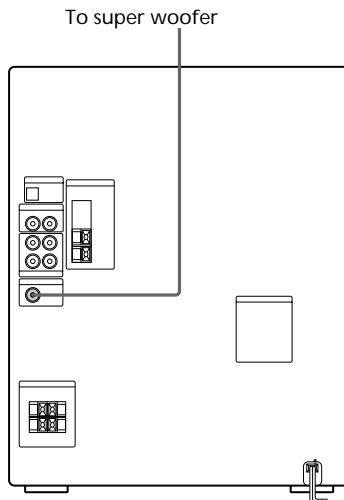

## Connecting a VCR

Make sure to match the color of the plugs and the connectors. To listen to the sound of the connected VCR, press FUNCTION repeatedly until "VIDEO" appears. Refer to the instructions of each component.

To the audio output of the VCR

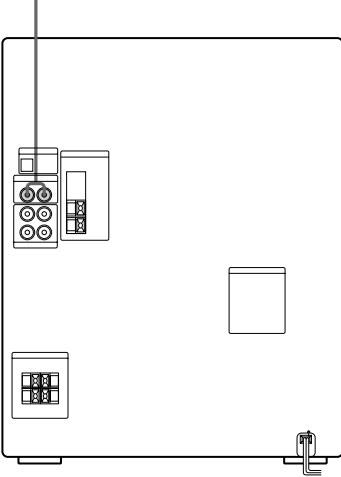

## Connecting the surround speakers

(MHC-GRX70/GRX70J only)

Connect the speaker cords from the surround speakers to the appropriate SURROUND SPEAKER jacks. Connect the solid cords to the red jacks and connect the striped cords to the black jacks.

Keep the speaker cords away from the antennas to prevent noise.

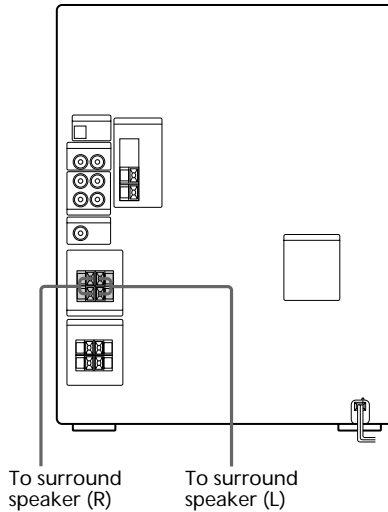

# Connecting outdoor antennas

Connect the outdoor antenna to improve the reception. Refer to the instructions of each component.

## FM antenna

Connect the optional FM outdoor antenna. You can also use the TV antenna instead.

Jack type Ⓐ

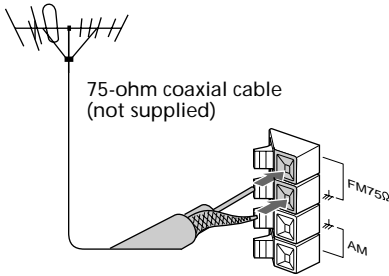

Jack type Ⓑ

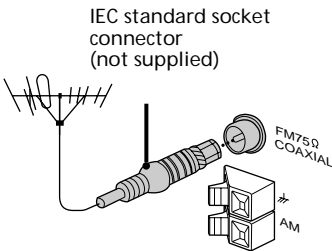

## AM antenna

Connect a 6- to 15- meter (20- to 50- feet) insulated wire to the AM antenna terminal. Leave the supplied AM loop antenna connected.

Jack type Ⓐ

Insulated wire (not supplied)

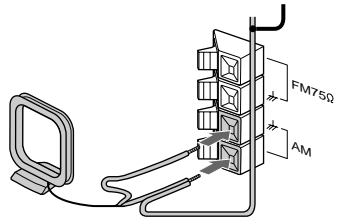

Jack type Ⓑ

Insulated wire (not supplied)

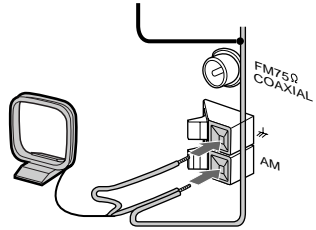

## Precautions

### On operating voltage

Before operating the system, check that the operating voltage of your system is identical with the voltage of your local power supply.

### On safety

- The unit is not disconnected from the AC power source (mains) as long as it is connected to the wall outlet, even if the unit itself has been turned off.
- Unplug the system from the wall outlet (mains) if it is not to be used for an extended period of time. To disconnect the cord (mains lead), pull it out by the plug. Never pull the cord itself.
- Should any solid object or liquid fall into the component, unplug the stereo system and have the component checked by qualified personnel before operating it any further.
- The AC power cord must be changed only at the qualified service shop.

### On placement

- Place the stereo system in a location with adequate ventilation to prevent heat build-up in the stereo system.
- Do not place the unit in an inclined position.
- Do not place the unit in locations where it is:
  - Extremely hot or cold
  - Dusty or dirty
  - Very humid
  - Vibrating
  - Subject to direct sunlight.

### On operation

- If the stereo system is brought directly from a cold to a warm location, or is placed in a very damp room, moisture may condense on the lens inside the CD player. Should this occur, the system will not operate properly. Remove the CD and leave the system turned on for about an hour until the moisture evaporates.
- When you move the system, take out any discs.

If you have any questions or problems concerning your stereo system, please consult your nearest Sony dealer.

## Notes on CDs

- Before playing, clean the CD with a cleaning cloth. Wipe the CD from the center out.
- Do not use solvents such as benzene, thinner, commercially available cleaners or anti-static spray intended for vinyl LPs.
- Do not expose the CD to direct sunlight or heat sources such as hot air ducts, nor leave it in a car parked in direct sunlight.

## Cleaning the cabinet

Use a soft cloth slightly moistened with mild detergent solution.

## To save a tape permanently

To prevent a tape from being accidentally recorded over, break off the cassette tab from side A or B as illustrated.

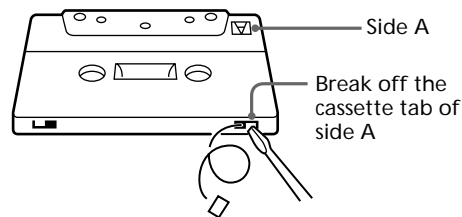
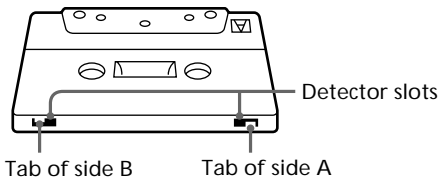

If you later want to reuse the tape for recording, cover the broken tab with adhesive tape. However, be careful not to cover the detector slots which allow the tape player to automatically detect the type of tape.

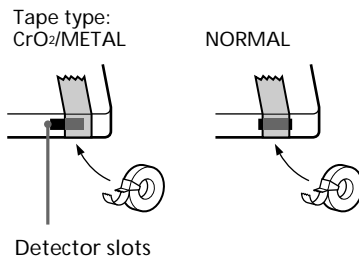

continued

## Precautions (continued)

### Before placing a cassette in the tape deck

Take up any slack in the tape. Otherwise the tape may get entangled in the parts of the tape deck and become damaged.

### When using a tape longer than 90 minutes

The tape is very elastic. Do not change the tape operations such as play, stop, and fast-winding etc. frequently. The tape may get entangled in the tape deck.

### Cleaning the tape heads

Clean the tape heads after every 10 hours of use. When the tape heads become dirty;

- the sound is distorted
- there is a decrease in sound level
- the sound drops out
- the tape does not erase completely
- the tape does not record.

Make sure to clean the tape heads before you start an important recording or after playing an old tape. Use separately sold dry-type or wet-type cleaning cassette. For details, refer to the instructions of the cleaning cassette.

### Demagnetizing the tape heads

Demagnetize the tape heads and the metal parts that have contact with the tape every 20 to 30 hours of use with a separately sold demagnetizing cassette. For details, refer to the instructions of the demagnetizing cassette.

---

## Troubleshooting

If you run into any problem using this stereo system, use the following check list.

First, check that the power cord is connected firmly and the speakers are connected correctly and firmly.

Should any problem persist, consult your nearest Sony dealer.

## General

---

The display starts flashing as soon as you plug in the power cord even though you haven't turned on the power (demonstration mode).

- Press DISPLAY (MHC-RXD9/RXD80/RXD7/R770) or DEMO (STANDBY) (MHC-GRX9900/GRX70/GRX70J/GRX50) when the power is turned off. The demonstration disappears.

The demonstration mode appears automatically the first time you plug in the power cord or if there is a power outage lasting longer than half a day.

---

The clock setting/radio presetting/timer is canceled.

- The power cord is disconnected or a power failure occurs longer than half a day.  
Redo the followings:
    - “Step 2: Setting the time”
    - “Step 3: Presetting radio stations”
- If you have set the timer, also redo “Waking up to music” and “Timer-recording radio programs”.

---

There is no sound.

- Rotate VOLUME clockwise.
- The headphones are connected.
- Insert only the stripped portion of the speaker cord into the SPEAKER jack. Inserting the vinyl portion of the speaker cord will obstruct the speaker connections.
- There is no audio output during timer recording.

---

There is severe hum or noise.

- A TV or VCR is placed too close to the stereo system. Move the stereo system away from the TV or VCR.

---

"0:00" (or "12:00") flashes in the display.

- A power interruption occurred. Set the clock and timer settings again.

---

The timer does not function.

- Set the clock correctly.

---

DAILY 1, DAILY 2, and REC do not appear when you press the TIMER SELECT button.

- Set the timer correctly.
- Set the clock.

---

The remote does not function.

- There is an obstacle between the remote and the system.
- The remote is not pointing in the direction of the system's sensor.
- The batteries have run down. Replace the batteries.

---

There is acoustic feedback.

- Decrease the volume level.
- Move the microphone away from the speakers or change the direction of the microphone.

---

The color irregularity on a TV screen persists.

- Turn off the TV set once, then turn it on after 15 to 30 minutes. If the color irregularity still persists, place the speakers farther away from the TV set.

---

"PROTECT" and "PUSH POWER" appear alternately.

- A strong signal was input. Press | / ⏻ to turn off the power, leave the system turned off for a while, then press | / ⏻ again to turn on the power.
- 

## Speakers

---

Sound comes from one channel or unbalanced left and right volume.

- Check the speaker connection and speaker placement.

---

Sound lacks bass.

- Check that the speaker's + and - jacks are connected correctly.
- 

## CD Player

---

The CD tray does not close.

- The CD is not placed properly.

---

The CD will not play.

- The CD is not lying flat in the disc tray.
- The CD is dirty.
- The CD is inserted label side down.
- Moisture condensation has built up. Remove the CD and leave the system turned on for about an hour until the moisture evaporates.

---

Play does not start from the first track.

- The player is in program or shuffle mode. Press PLAY MODE repeatedly until "PROGRAM" or "SHUFFLE" disappear.

---

"OVER" is displayed.

- You have reached the end of the CD. Press and hold ◀◀ to return.
- 

continued

## Troubleshooting (continued)

### Tape Deck

---

The tape does not record.

- No tape in the cassette holder.
  - The tab has been removed from the cassette (see “To save a tape permanently” on page 45).
  - The tape has reeled to the end.
- 

The tape does not record nor play or there is a decrease in sound level.

- The heads are dirty. Clean them (see “Cleaning the tape heads” on page 46).
  - The record/playback heads are magnetized. Demagnetize them (see “Demagnetizing the tape heads” on page 46).
- 

The tape does not erase completely.

- The record/playback heads are magnetized. Demagnetize them (see “Demagnetizing the tape heads” on page 46).
- 

There is excessive wow or flutter, or the sound drops out.

- The capstans or pinch rollers are dirty. Clean them (see “Cleaning the tape heads” on page 46).
- 

Noise increases or the high frequencies are erased.

- The record/playback heads are magnetized. Demagnetize them (see “Demagnetizing the tape heads” on page 46).
- 

After pressing ► (◀) or ≡, there is a mechanical noise, “EJECT” appears in the display, and the unit enters standby mode automatically.

- The cassette tape was not inserted correctly. Eject the tape and turn the power back on.
- 

### Tuner

---

Severe hum or noise (“TUNED” or “STEREO” flashes in the display).

- Adjust the antenna.
  - The signal strength is too weak. Connect the external antenna.
- 

A stereo FM program cannot be received in stereo.

- Press STEREO/MONO so that “STEREO” appears.
- 

**If other troubles not described above occur, reset the system as follows:**

- 1 Unplug the power cord.
- 2 Plug the power cord back in.
- 3 Press ■, ENTER/NEXT, and | / ⏻ at the same time.
- 4 Press | / ⏻ to turn on the power.

The system is reset to the factory settings. All the settings you made, such as the preset stations, clock, and timer are cleared. You should set them again.



# Specifications

## AUDIO POWER SPECIFICATIONS: (MHC-RXD9 U.S.A. models only)

### POWER OUTPUT AND TOTAL HARMONIC DISTORTION:

with 8 ohm loads both channels driven, from 70-20,000 Hz; rates 140 watts per channel minimum RMS power, with no more than 0.9% total harmonic distortion from 250 milliwatts to rated output.

### Amplifier section

#### Canadian models:

##### MHC-RXD80:

Continuous RMS power output (reference)  
100 + 100 watts  
(8 ohms at 1 kHz,  
10% THD)  
Total harmonic distortion less than 0.07%  
(8 ohms at 1 kHz, 55 W)

##### MHC-RXD7:

Continuous RMS power output (reference)  
70 + 70 watts  
(6 ohms at 1 kHz,  
10% THD)  
Total harmonic distortion less than 0.07%  
(6 ohms at 1 kHz, 45 W)

#### European models:

##### MHC-RXD9:

DIN power output (rated) 120 + 120 watts  
(8 ohms at 1 kHz, DIN)  
Continuous RMS power output (reference)  
150 + 150 watts  
(8 ohms at 1 kHz,  
10% THD)

Music power output (reference)  
275 + 275 watts  
(8 ohms at 1 kHz,  
10% THD)

##### MHC-R770/RXD7:

DIN power output (rated) 80 + 80 watts  
(8 ohms at 1 kHz, DIN)  
Continuous RMS power output (reference)  
100 + 100 watts  
(8 ohms at 1 kHz,  
10% THD)

Music power output (reference)  
170 + 170 watts  
(8 ohms at 1 kHz,  
10% THD)

#### Other models:

##### MHC-GRX9900:

The following measured at AC 120, 220, 240 V  
50/60 Hz  
DIN power output (rated) 200 + 200 watts  
(6 ohms at 1 kHz, DIN)  
Continuous RMS power output (reference)  
250 + 250 watts  
(6 ohms at 1 kHz,  
10% THD)

##### MHC-GRX70/GRX70J:

The following measured at AC 120, 220, 240 V  
50/60 Hz  
DIN power output (rated) 130 + 130 watts  
(6 ohms at 1 kHz, DIN)  
Continuous RMS power output (reference)  
170 + 170 watts  
(6 ohms at 1 kHz,  
10% THD)

##### MHC-GRX50:

The following measured at AC 120, 220, 240 V  
50/60 Hz  
DIN power output (rated) 110 + 110 watts  
(8 ohms at 1 kHz, DIN)  
Continuous RMS power output (reference)  
140 + 140 watts  
(8 ohms at 1 kHz,  
10% THD)

continued

## Specifications (continued)

<b>Inputs</b>	
MD IN: (phono jacks)	voltage 450 mV, impedance 47 kilohms
VIDEO (AUDIO) IN: (phono jacks)	voltage 250 mV, impedance 47 kilohms
MIX MIC: (phone jack)	sensitivity 1 mV, impedance 10 kilohms
<b>Outputs</b>	
MD OUT: (phono jacks)	voltage 250 mV impedance 1 kilohms
PHONES: (stereo mini jack)	accepts headphones of 8 ohms or more
<b>SPEAKER:</b>	
MHC-GRX9900/GRX70/GRX70J/RXD7 (Canadian model):	accepts impedance of 6 to 16 ohms
MHC-RXD9/RXD7 (European model)/RXD80/R770/GRX50:	accepts impedance of 8 to 16 ohms
<b>SURROUND SPEAKER:</b> (MHC-GRX70/GRX70J only)	accepts impedance of 16 ohms
<b>SUPER WOOFER:</b> (except MHC-R770/ RXD7 (European model)/ RXD9 (European model))	Voltage 1 V, impedance 1 kilohm

## CD player section

<b>System</b>	Compact disc and digital audio system
<b>Laser</b>	Semiconductor laser ( $\lambda=780\text{nm}$ ) Emission duration: continuous
<b>Laser output</b>	Max. 44.6 $\mu\text{W}^*$ *This output is the value measured at a distance of 200 mm from the objective lens surface on the Optical Pick-up Block with 7 mm aperture.
<b>Wavelength</b>	780 – 790 nm
<b>Frequency response</b>	2 Hz – 20 kHz ( $\pm 0.5$ dB)
<b>Signal-to-noise ratio</b>	More than 90 dB
<b>Dynamic range</b>	More than 90 dB
<b>CD OPTICAL DIGITAL OUT</b> (Square optical connector jack, rear panel)	
<b>Wavelength</b>	660 nm
<b>Output Level</b>	-18 dBm

## Tape player section

<b>Recording system</b>	4-track 2-channel stereo
<b>Frequency response</b> (DOLBY NR OFF)	40 – 13,000 Hz ( $\pm 3$ dB), using Sony TYPE I cassette 40 – 14,000 Hz ( $\pm 3$ dB), using Sony TYPE II cassette
<b>Wow and flutter</b>	$\pm 0.15\%$ W.Peak (IEC) 0.1% W.RMS (NAB) $\pm 0.2\%$ W.Peak (DIN)

## Tuner section

FM stereo, FM/AM superheterodyne tuner

### FM tuner section

<b>Tuning range</b>	87.5 – 108.0 MHz
<b>Antenna</b>	FM lead antenna
<b>Antenna terminals</b>	75 ohm unbalanced
<b>Intermediate frequency</b>	10.7 MHz

### UKV tuner section

#### (3 band (FM-AM-UKV) models only)

<b>Tuning range</b>	65.0 – 74.0 MHz Stereo Plus
---------------------	--------------------------------

## AM tuner section

### Tuning range

#### 2 Band type:

North American models:	530 – 1,710 kHz (with the interval set at 10 kHz) 531 – 1,710 kHz (with the interval set at 9 kHz)
European models:	531 – 1,602 kHz (with the interval set at 9 kHz)
Other models:	531 – 1,602 kHz (with the interval set at 9 kHz) 530 – 1,710 kHz (with the interval set at 10 kHz)

#### 3 Band type:

#### Middle Eastern models:

MW:	531 – 1,602 kHz (with the interval set at 9 kHz)
SW:	5.95 – 17.90 MHz (with the interval set at 5 kHz)

#### Other models:

MW:	531 – 1,602 kHz (with the interval set at 9 kHz) 530 – 1,710 kHz (with the interval set at 10 kHz)
SW:	5.95 – 17.90 MHz (with the interval set at 5 kHz)

Antenna	AM loop antenna
Antenna terminals	External antenna terminal
Intermediate frequency	450 kHz

## Speaker

### SS-GRX9900/GRX9900G for MHC-GRX9900

Speaker system	2-way, 5-unit, bass-reflex type
Speaker units	
Woofer:	15 cm, cone type x2
Tweeter:	5 cm, cone type x3
Nominal impedance	6 ohms
Dimensions (w/h/d)	Approx. 250 x 430 x 355 mm
Mass	Approx. 8.5 kg net per speaker

### SS-RX900D for MHC-RXD9 (German model)

Speaker system	3-way, 5-unit, bass-reflex type
Speaker units	
Woofer:	15 cm, cone type x2
Center Tweeter:	5 cm, cone type
Side Tweeter:	5 cm, cone type x2
Nominal impedance	8 ohms
Dimensions (w/h/d)	Approx. 250 x 430 x 355 mm
Mass	Approx. 7.5 kg net per speaker

### SS-RXD9 for MHC-RXD9 (except for German model)

Speaker system	2-way, 5-unit, bass-reflex type
Speaker units	
Woofer:	15 cm, cone type x2
Tweeter:	5 cm, cone type x3
Nominal impedance	8 ohms
Dimensions (w/h/d)	Approx. 250 x 430 x 355 mm (10 x 17 x 14 in.)
Mass	Approx. 8.5 kg (16 lb 9 oz) net per speaker

### SS-RXD80 for MHC-RXD80/SS-RXD7S for MHC-RXD7 (European model)

Speaker system	4-way, 5-unit, bass-reflex type, magnetically shielded type
Speaker units	
Woofer:	17 cm, cone type
Center Tweeter:	5 cm, cone type
Side Tweeter:	5 cm, cone type x2
Super Tweeter:	4 cm, cone type
Nominal impedance	8 ohms
Dimensions (w/h/d)	Approx. 230 x 340 x 320 mm
Mass	Approx. 5.5 kg net per speaker

### SS-R770 for MHC-R770

Speaker system	4-way, 5-unit, bass-reflex type
Speaker units	
Woofer:	17 cm, cone type
Center Tweeter:	5 cm, cone type
Side Tweeter:	5 cm, cone type x2
Super Tweeter:	4 cm, cone type
Nominal impedance	8 ohms
Dimensions (w/h/d)	Approx. 230 x 340 x 320 mm
Mass	Approx. 5.5 kg net per speaker

### SS-GRX70/GRX70G for MHC-GRX70/SS-GRX70J for MHC-GRX70J

Speaker system	4-way, 5-unit, bass-reflex type, magnetically shielded type
Speaker units	
Woofer:	17 cm, cone type
Center Tweeter:	5 cm, cone type
Side Tweeter:	5 cm, cone type x2
Super Tweeter:	4 cm, cone type
Nominal impedance	6 ohms
Dimensions (w/h/d)	Approx. 230 x 340 x 320 mm
Mass	Approx. 5.5 kg net per speaker

continued

## Specifications (continued)

### SS-RXD7 for MHC-RXD7 (Canadian model)

Speaker system	3-way, bass-reflex type
Speaker units	
Woofer:	17 cm, cone type
Tweeter:	5 cm, cone type
Super Tweeter:	2 cm, dome type
Nominal impedance	6 ohms
Dimensions (w/h/d)	Approx. 220 x 340 x 280 mm
Mass	Approx. 4 kg net per speaker

### SS-GRX50/GRX50G for MHC-GRX50

Speaker system	3-way, bass-reflex type
Speaker units	
Woofer:	17 cm, cone type
Tweeter:	5 cm, cone type
Super Tweeter:	2 cm, dome type
Nominal impedance	8 ohms
Dimensions (w/h/d)	Approx. 220 x 340 x 280 mm
Mass	Approx. 4 kg net per speaker

## General

### Power requirements

North American models:	120 V AC, 60 Hz
European models:	230 V AC, 50/60 Hz
Australian models:	230-240 V AC, 50/60 Hz
Mexican models:	120 V AC, 50/60 Hz
Israel, South African and Thai models:	220 V AC, 50/60 Hz
Other models:	220 V, 220 V or 230 - 240 V AC, 50/60 Hz Adjustable with voltage selector

### Power consumption

U.S.A. models:	
MHC-RXD9:	170 watts
Canadian model:	
MHC-RXD7:	130 watts
MHC-RXD80:	170 watts
European models:	
MHC-R770/RXD7:	165 watts
MHC-RXD9:	180 watts
Other models:	
MHC-GRX50:	160 watts
MHC-GRX70/GRX70J:	170 watts
MHC-GRX9900:	240 watts

### Dimensions (w/h/d)

MHC-GRX9900/RXD9	Approx. 280 x 360 x 395 mm (13 <sup>1</sup> / <sub>8</sub> x 14 <sup>1</sup> / <sub>4</sub> x 15 <sup>5</sup> / <sub>8</sub> in.)
Other models:	Approx. 280 x 340 x 395 mm (13 <sup>1</sup> / <sub>8</sub> x 13 <sup>1</sup> / <sub>2</sub> x 15 <sup>5</sup> / <sub>8</sub> in.)

### Mass

U.S.A. models:	
MHC-RXD9:	Approx. 10.6 kg (23 lb 6 oz.)
Canadian models:	
MHC-RXD7:	Approx. 9.2 kg
MHC-RXD80:	Approx. 10.2 kg
European models:	
MHC-R770/RXD7:	Approx. 10.1 kg
MHC-RXD9:	Approx. 10.8 kg
Other models:	
MHC-GRX50:	Approx. 10.0 kg
MHC-GRX70/GRX70J:	Approx. 10.6 kg
MHC-GRX9900:	Approx. 12.2 kg

### Supplied accessories:

AM loop antenna (1)
Remote Commander (1)
Batteries (2)
FM lead antenna (1)
Speaker cords (2 for front speakers with jacks only)
Front speaker pads (8)

### Optional accessories:

(MHC-GRX70/GRX70J only)	Surround speaker
Speaker system	SS-SR125
	1-way, 1-unit, bass-reflex type

### Speaker units:

Full range	8 cm dia., cone type
Nominal impedance	16 ohms
Dimensions (w/h/d)	Approx. 220 x 100 x 195 mm
Mass	Approx. 1.0 kg net per speaker

Design and specifications are subject to change without notice.



# Parts identification

## MHC-GRX70/GRX70J/GRX50/R770/RXD80/RXD7

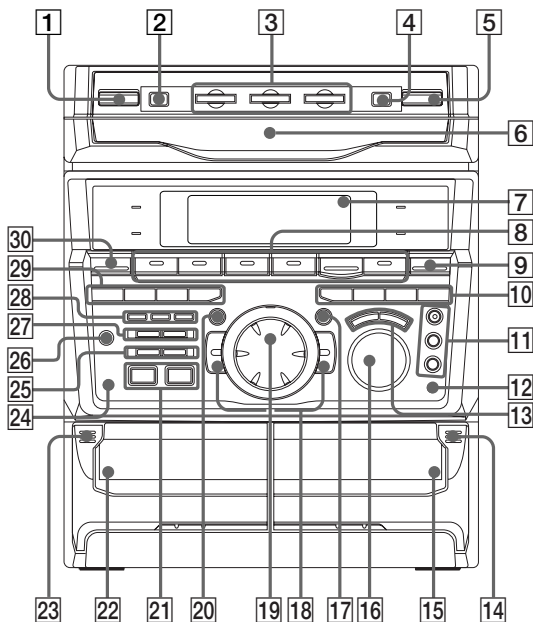

- 1 | / ⏻ (power) button
- 2 | POWER SAVE/DEMO button
- 3 | DISC 1~3 buttons
- 4 | DISC SKIP/EXCHANGE button
- 5 | CD ⇨ button
- 6 | Disc tray
- 7 | Display
- 8 | CD/tape operating buttons:
  - CD ▶▶ || (play/pause)
  - TAPE A ▶▶ (play)
  - TAPE A ◀◀ (play)
  - TAPE B ▶▶ (play)
  - TAPE B ◀◀ (play)
  - (stop)
- 9 | TUNER/BAND button
- 10 | NON-STOP button  
KARAOKE PON/MPX button  
SYNC EQ button  
SYNC BASS button
- 11 | Operating buttons for recording:
  - REC PAUSE/START button
  - HI-DUB button
  - CD SYNC button
- 12 | PHONES jack
- 13 | DBFB button  
SURROUND button
- 14 | Deck B ⇨ button
- 15 | Deck B
- 16 | VOLUME control
- 17 | ENTER/NEXT button
- 18 | ◀◀/▶▶, +/- buttons
- 19 | Jog dial
- 20 | GROOVE button
- 21 | Operating buttons for DJ Effects:
  - LOOP button
  - FLASH button
- 22
- 23
- 24
- 25
- 26
- 27
- 28
- 29
- 30

# MHC-GRX9900/RXD9

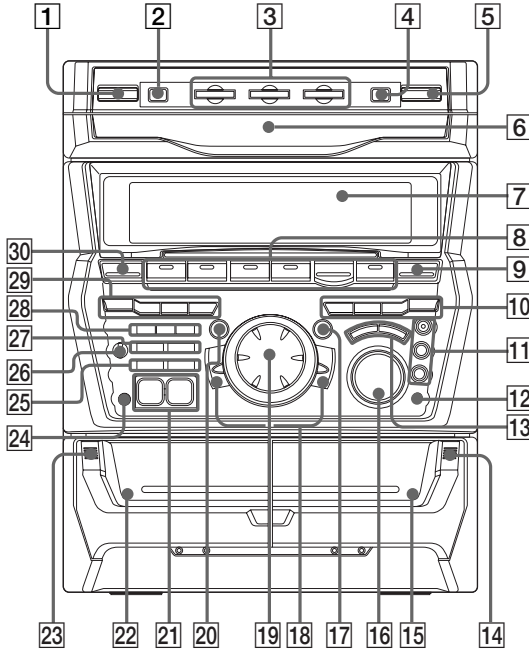

- 22** Deck A
- 23** Deck A  $\cong$  button
- 24** MIX MIC jack
- 25** Clock/timer operating buttons:  
CLOCK/TIMER set button  
TIMER SELECT button
- 26** MIC LEVEL control
- 27** DISPLAY button
- 28** SPECTRUM ANALYZER button
- 29** For MHC-GRX9900/GRX70/GRX70J/  
RXD9/RXD80  
EFFECT button  
FILE SELECT button  
GEQ CONTROL button  
P FILE MEMORY button  
For MHC-GRX50/R770/RXD7  
EDIT, DIRECTION, TUNER MEMORY  
button  
PLAY MODE, DOLBY NR(, PTY\*) button  
REPEAT, STEREO/MONO button  
FILE SELECT button
- 30** FUNCTION button
- 24** For MHC-GRX9900/GRX70/GRX70J/  
RXD9/RXD80 only  
EDIT, DIRECTION, TUNER MEMORY  
button  
PLAY MODE, DOLBY NR(, PTY\*) button  
REPEAT, STEREO/MONO button

\* For European models only.

---

# Index

## A

- Adjusting
  - the audio emphasis 29
  - the sound 28
  - the volume 12, 14, 17
- Antennas 6, 44
- Automatic Source Selection 12, 15, 17

## B

- Batteries 7

## C

- CD player 11, 19-23
- CD Synchro Recording 13
- Clock setting 7
- Connecting. *See* Hooking up

## D, E

- Display 19

## F, G

- Flash 27

## H, I, J

- Hooking up
  - optional components 41-44
  - the antennas 6, 44
  - the power 6
  - the system 5

## K

- Karaoke 36

## L, M

- Loop 27

## N

- Normal Play 11

## O

- One Touch Play 12, 15, 17

## P, Q

- Personal file 33
- Playing
  - a CD 11
  - a preset station 14
  - a tape 16
  - tracks in random order (Shuffle Play) 21
  - tracks in the desired order (Program Play) 22
  - tracks repeatedly (Repeat Play) 20
- Presetting radio stations 8
- Preset tuning 14
- Program Play 22
- Protecting recordings 45
- PTY 34

## R

- Radio Data System 34
- Radio stations
  - presetting 8
  - tuning in 14
- Recording
  - a CD 13
  - a radio program 15
  - timer recording 40
- Repeat Play 20
- Resetting the system 48

## S

- Saving recordings 45
- Selecting the audio emphasis 29
- Setting the time 7
- Shuffle Play 21
- Sleep Timer 38
- Sound adjustment 28
- Speakers 5
- Station name 34

## T, U, V

- Timer
  - falling asleep to music 38
  - timer recording 40
  - waking up to music 39
- Troubleshooting 46
- Tuner 8, 14
- Tuning interval 9

## W, X, Y, Z

- Wake-up timer 39