

# *Trinitron Color Video TV*

---

Operating Instructions \_\_\_\_\_ **GB**

Before operating the unit, please read this manual thoroughly and retain it for future reference.

##### \_\_\_\_\_ **AR**



PAL NTSC

*KV-VF21M70*

# WARNING

To prevent fire or shock hazard, do not expose the unit to rain or moisture.

Dangerously high voltages are present inside the set. Do not open the cabinet. Refer servicing to qualified personnel only.

## Safety information

This unit operates on extremely high voltages. To prevent fire or electric shock, please follow the safety procedures below. For your protection, refer all servicing to qualified personnel only.

For general safety:

- Do not expose the unit to rain or moisture.
- Do not open the rear cover.

For safe installation:

- Do not block the ventilation openings.
- Do not install the unit in hot, humid or excessively dusty places.
- Do not install the unit where it may be exposed to mechanical vibrations.

For safe operation:

- Do not operate the unit on anything but 110–240 V AC.
- Do not operate the unit if any liquid or solid object falls inside it—have it checked immediately.
- Unplug the unit from the wall outlet if you do not intend to use it for an extended period of time. To disconnect the cord, pull it out by the plug, never by the cord.

## About moisture condensation

If the unit is brought directly from a cold place to a warm place, moisture may condense on the video head drum. If this happens, the tape may stick to the head drum and it may be damaged or the unit may not operate correctly. To avoid possible damage caused by moisture condensation, be sure not to leave a cassette inside the compartment when the unit is not in use. When bringing the unit from a cold place to a warm place, turn on the unit's power and wait for more than 2 hours before operating it.

## Caution

Television programs, films, video tapes and other materials may be copyrighted.

Unauthorized recording of such materials may be contrary to the provisions of the copyright laws.

## Color system of your set

This video TV is designed to receive TV programs based on PAL (B/G, I and D/K), SECAM (B/G and D/K) and NTSC (M) color systems and to record and play on PAL, MESECAM and NTSC color systems.

# Table of Contents

## WARNING

### Getting Started

Step 1: Preparation .....	4
Step 2: Installing the video TV .....	5
Step 3: Connecting the antenna .....	6
Step 4: Selecting the language .....	7
Step 5: Setting the clock .....	9
Step 6: Setting the channels .....	11

### Basic Operations

Watching the TV .....	14
Playing a tape .....	16
Displaying on-screen information .....	18
Recording TV programs .....	19
Recording TV programs .....	19
Recording using QUICK-TIMER ..	22
Recording TV programs using the timer .....	26
Checking/adding/changing/ canceling the timer settings .....	28

### Additional Operations

Adjusting the TV .....	29
Adjusting the volume — INTELLIGENT VOL .....	29
Presetting channels manually ....	30
Skipping program positions .....	32
Adjusting the TV system .....	33
Adjusting the color system .....	34
Changing the PICTURE MODE setting .....	35
Adjusting the alignment of the picture .....	36

### Tape options ..... 37 |

Adjusting the tracking .....	37
Adjusting with Adaptive Picture Control (APC) .....	38
Playing a tape repeatedly .....	39
Adjusting the picture for rental tapes .....	40
When connecting to a Sony VCR .	41
Setting the color system .....	42
Switching off automatically — SLEEP .....	43
Switching on automatically — ON TIMER .....	44
Searching using the index function ...	46
Connecting optional equipment ....	47
Watching and recording the picture input from optional equipment .	47

### Additional Information

Self-diagnosis function .....	50
Troubleshooting .....	51
Identifying parts and controls .....	55
Specifications .....	59

## Step 1: Preparation

### Check the supplied accessories

When you have taken everything out of the carton, check that you have these items:

- Remote control
- Two R6 (size AA) batteries
- Stabilizer band
- Two clamps
- Two wood screws
- AC plug adaptor
- These operating instructions

### Insert the batteries into the remote control

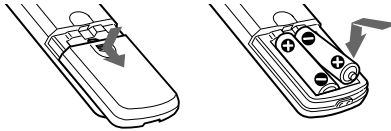

#### Note

- Do not use old batteries or different types of batteries together.

## Step 2: Installing the video TV

### Secure the video TV

To prevent the video TV from falling, secure it using one of the following methods:

- A** With the supplied screws, attach the stabilizer band to the TV stand and to the rear of the video TV using the existing hole.

OR

- B** Pass a cord or chain through the clamps and secure them to the rear of the video TV and a wall or pillar.

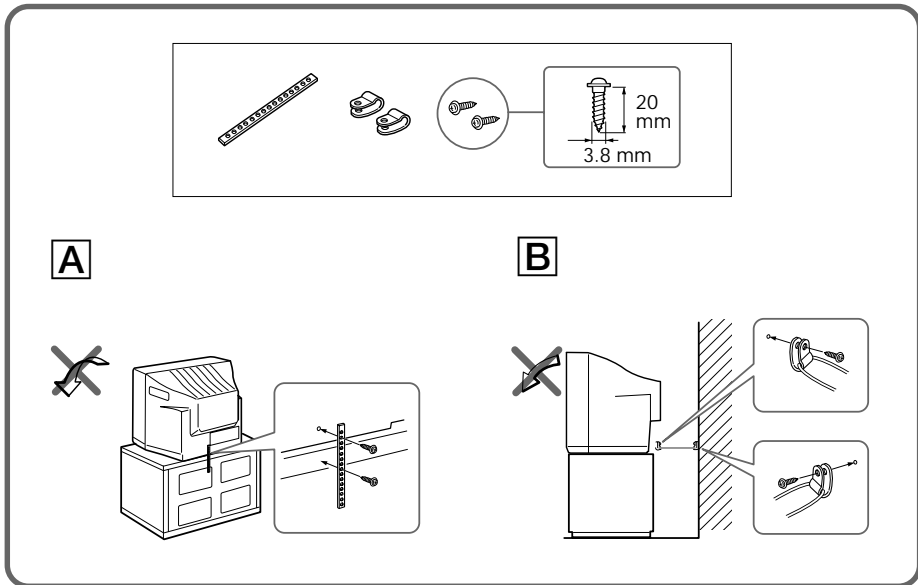

# Step 3: Connecting the antenna

For better TV reception and clear recordings, connect an outdoor antenna to your video TV.

## Connecting an outdoor antenna

To connect a VHF antenna or a combination VHF/UHF antenna—75-ohm coaxial cable (round)

Attach an IEC antenna connector to the 75-ohm coaxial cable.  
Plug the connector into the  $\Upsilon$  (antenna) socket of the video TV.

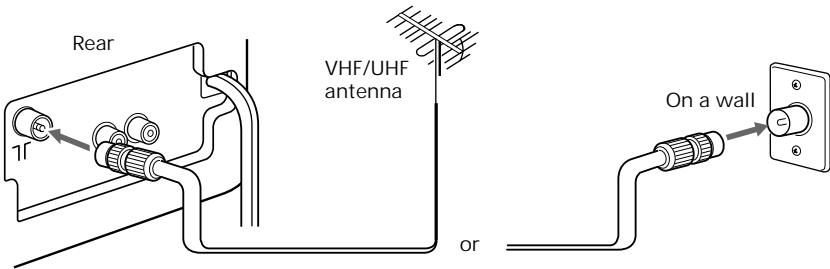

To connect both VHF and UHF antennas

Attach the antenna cable ends to the VHF/UHF mixer (not supplied).  
Plug the mixer into the  $\Upsilon$  (antenna) socket of the video TV.

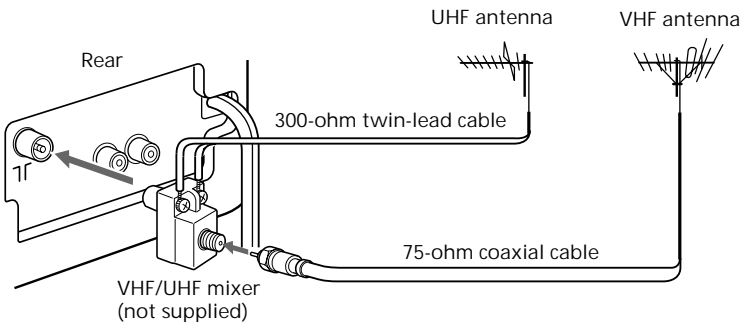

## Step 4: Selecting the language

You can change the menu and on-screen information language to Chinese.

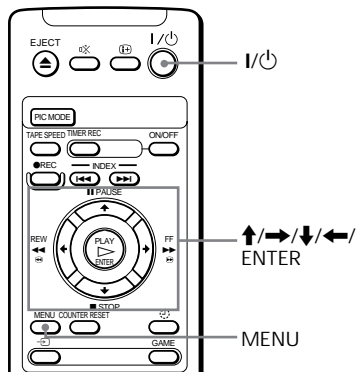
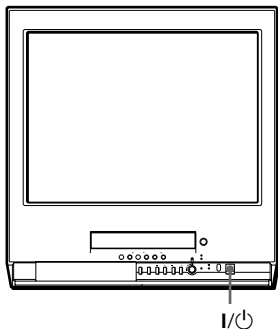

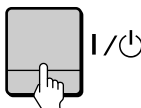

- 1 Press I/⏻ to turn on the video TV.

When the TV is in standby mode (the ⏻ indicator on the video TV is lit in red), press I/⏻, PROGR +/- or a number button on the remote control.

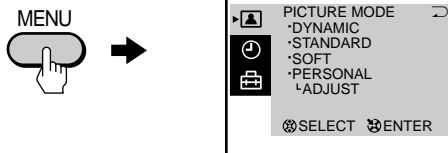

- 2 Press MENU.



- 3 Press ↑ or ↓ to select , then press ENTER.

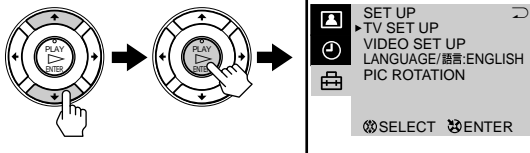

continued

---

*Step 4: Selecting the language (continued)*

---

- 4 Press **↑** or **↓** to select LANGUAGE/ 語言, then press ENTER. The selected item turns red.

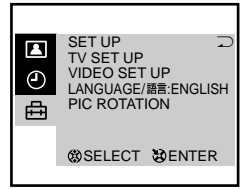
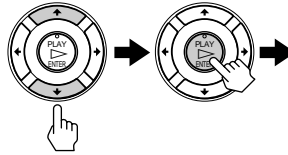

- 5 Press **↑** or **↓** to select 中文, then press ENTER. The menu language changes to Chinese.
- 

To return to the normal screen  
Press MENU.



## Step 5: Setting the clock

You need to set the clock to use timer recording, Quick-Timer recording and on-timer functions.

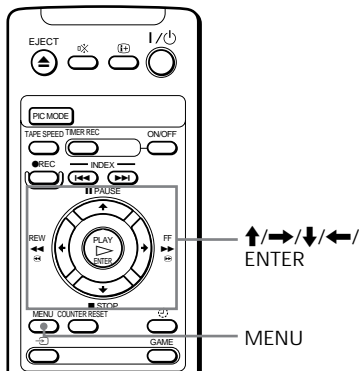

- 1 Press MENU.

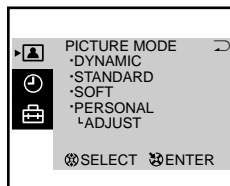

- 2 Press  $\uparrow$  or  $\downarrow$  to select  $\odot$ , then press ENTER.

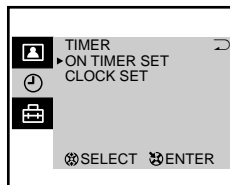
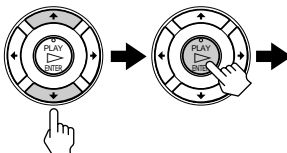

- 3 Press  $\uparrow$  or  $\downarrow$  to select CLOCK SET, then press ENTER.

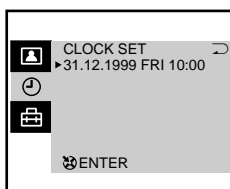
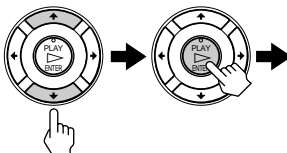

- 4 Press ENTER.  
The day section turns red.

- 5 Press  $\uparrow$  or  $\downarrow$  to set the day, then press  $\rightarrow$ .  
The month section turns red.

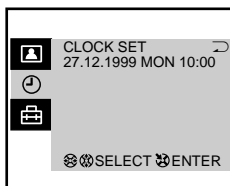
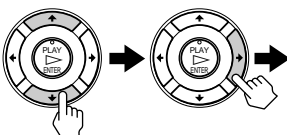

continued

---

## Step 5: Setting the clock (continued)

---

6 Press **↑**, **↓** or **→** to set the month, year, hour and minutes in the same way as in step 5, then press ENTER.

The clock starts working.

---

To return to the normal screen

Press MENU.

If you have made a mistake while setting the clock

Press **←** to go back to the item to be changed and set the correct digits using **↑** or **↓**, then press **→**.

Note

- If power is interrupted or you disconnect the AC power cord, you have to re-set the clock.

## Step 6: Setting the channels

### Presetting channels automatically

You can preset up to 100 channels.

Automatic presetting is the easiest way to setup your video TV if you want to preset all receivable channels at once.

To preset the channels manually, see page 30.

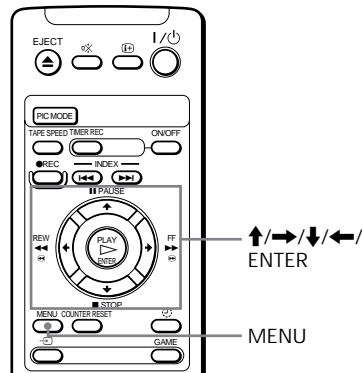

- 1 Press MENU.

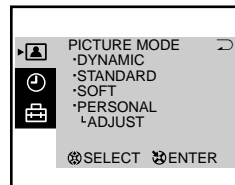

- 2 Press **↑** or **↓** to select , then press ENTER.

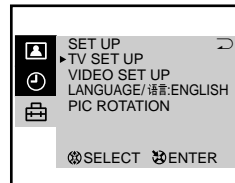
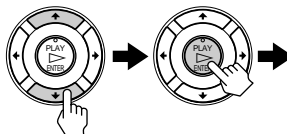

- 3 Make sure TV SET UP is selected, then press ENTER.

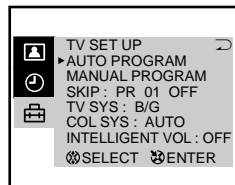

- 4 Press **↑** or **↓** to select TV SYS, then press ENTER.
- The selected item turns red.
- Press **↑** or **↓** to select the TV system (B/G, I, D/K or M) and press ENTER.

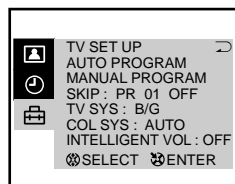
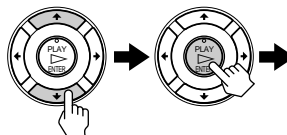

continued

## Step 6: Setting the channels (continued)

- 5 Press **↑** or **↓** to select AUTO PROGRAM, then press ENTER.

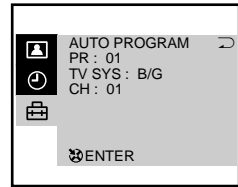
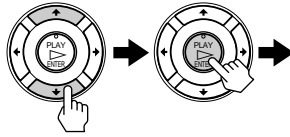

Presetting starts from program position 1. The preset program and channel numbers are displayed on the screen in sequence. When presetting is finished, program position 1 appears again. All available channels are now stored on successive number buttons.

### Tip

- To stop automatic channel presetting, press MENU.

Presetting channels automatically using the TUNER PRESET ON/OFF button on the video TV

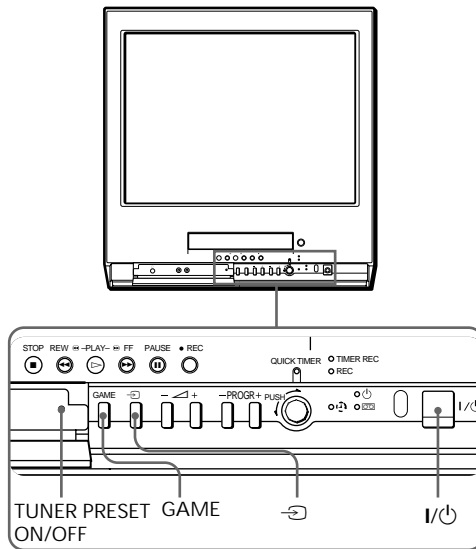

- 1 Press I/⏻ to turn on the video TV.  
When the TV is in standby mode (the ⏻ indicator on the video TV is lit in red), press I/⏻, PROGR +/- or a number button on the remote control.

- 2 Press TUNER PRESET ON/OFF with a pointed object.  
Do not use an item (such as a pencil) that might break off when inserted.

- 3 Press ↵ to select the TV system of the channels which you want to preset.

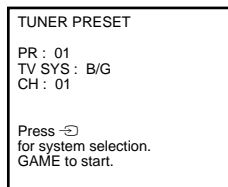
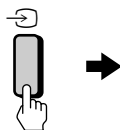

- 4 Press GAME.



Presetting starts from program position 1. The preset program and channel numbers are displayed on the screen in sequence.

When presetting is finished, program position 1 appears again. All available channels are now stored on successive number buttons.

## Watching the TV

This section explains various functions used while watching the TV. Most operations can be done using the remote control.

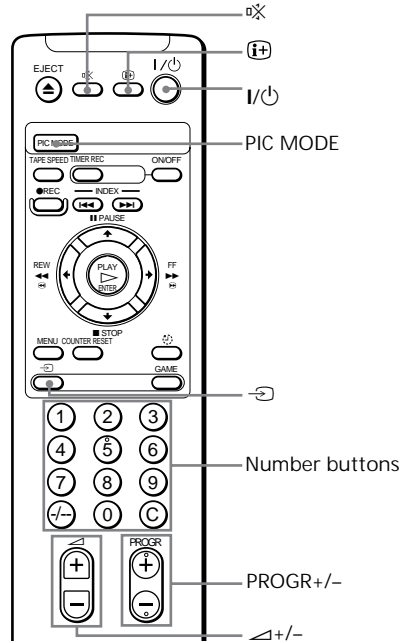
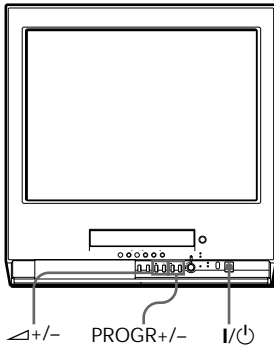

- 1 Press I/⏻ to turn on the video TV.

When the TV is in standby mode (the ⏻ indicator on the video TV is lit in red), press I/⏻ on the remote control.

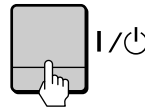

- 2 Press PROGR +/- or the number buttons to select the TV channel.

For double digit numbers, press +/-, then the numbers (e.g., for 25, press +/-, then 2 and 5).

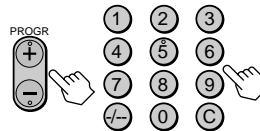

### Note

- You can also select the channel number directly with the number buttons. Press C (once for regular channels, twice for cable channels), the desired number buttons, then ENTER.

## Additional tasks

To	Press
Turn off temporarily	I/⏻ on the remote control. The ⏻ indicator on the video TV lights up in red.
Turn off the main power	I/⏻ on the video TV. The ⏻ indicator on the video TV lights up in orange.
Adjust the volume	⏮ +/-.
Mute the sound	🔇.
Watch the video input (from a connected VCR, camcorder, etc.)	⏮ to select “⏮1” or “⏮2” (see page 48). To return to the TV screen, press ⏮ again.

## Selecting the picture mode

Press PIC MODE repeatedly until the desired picture mode is selected.

Select	To
DYNAMIC	receive high contrast pictures.
STANDARD	receive normal contrast pictures.
SOFT	receive low contrast pictures.
PERSONAL	receive the latest picture settings from the ADJUST option in the PICTURE MODE menu (see page 35).

## Displaying on-screen information

Press ⓘ to display the following on-screen information.

To have the program number and channel number stay on the screen, press ⓘ again.

To make the information disappear, press ⓘ until no information is displayed on the screen.

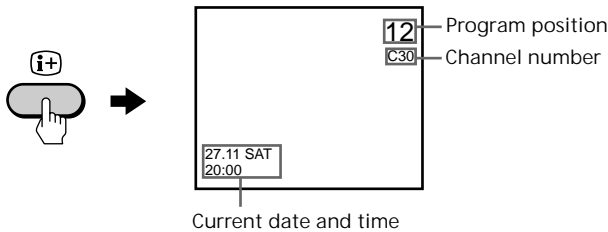

# Playing a tape

This section shows you how to play a tape. Other convenient functions you can use while playing a tape are explained in “Additional Operations.”

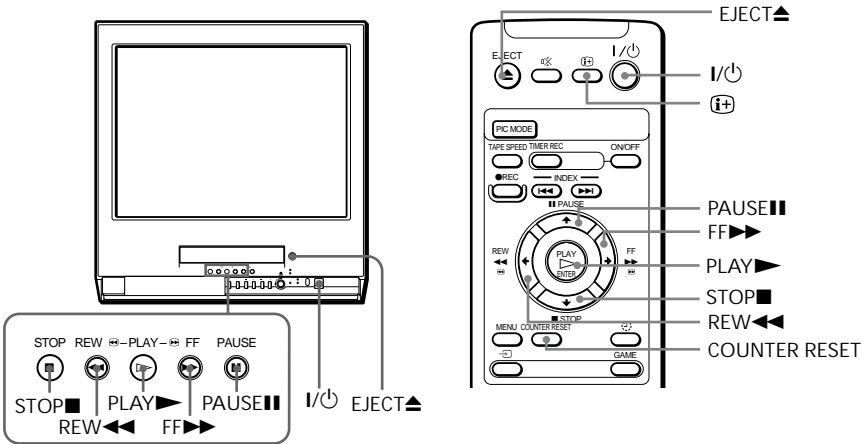

- 1 Press I/⏻ to turn on the video TV.  
When the TV is in standby mode (the ⏻ indicator on the video TV is lit in red), skip this step.
- 2 Insert a cassette.  
If you insert a cassette with its safety tab removed, playback starts automatically.
- 3 Press PLAY ▶.  
Playback starts. On-screen information is displayed for a few seconds.



**Note**

- The picture’s color may be affected when playing a MESECAM-recorded tape in the LP mode.



## Additional tasks

To	Press
stop playback	STOP ■. The video TV goes back to the normal TV picture.
stop playback for a moment	PAUSE ■■. Press PAUSE ■■ again or press PLAY ► to resume playback. If you leave your video TV in pause mode, normal playback resumes after about 5 minutes to prevent tape damage.
search a tape at high speed	REW ◀◀ ⏪ (rewind) or FF ▶▶ ⏩ (fast-forward) during playback. To resume normal playback, press PLAY ►.
fast-forward the tape	STOP ■, then press FF ▶▶.
rewind the tape	STOP ■, then press REW ◀◀.
view the picture in fast-forward or rewind mode	and hold FF ▶▶ during fast-forward or REW ◀◀ during rewind. When you release the button, fast-forward or rewind mode is resumed.
eject a cassette	EJECT ▲. You can eject the cassette even if the power is off.

## Protecting your cassette against accidental erasure

To prevent accidental erasure, break off the safety tab as illustrated. To record on a cassette without a safety tab, simply cover the tab hole with adhesive tape.

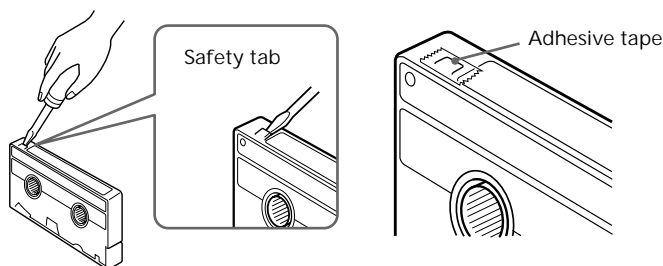

continued

## Playing a tape (continued)

### Displaying on-screen information

Press **i+** to display the following on-screen information. To show only the amount of remaining tape and the linear tape counter on the screen, press **i+** again.

To make the information disappear, press **i+** until no information is displayed on the screen.

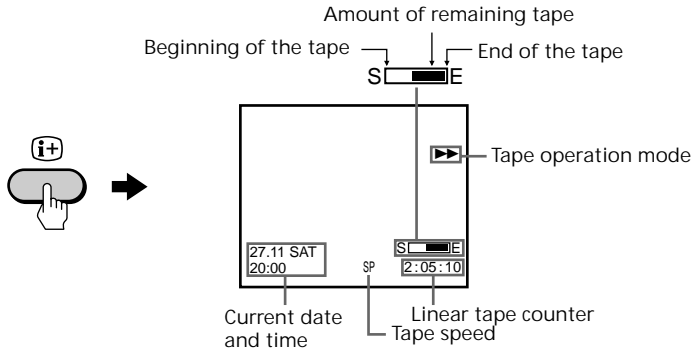

### Resetting the tape counter

The tape counter helps you to locate a certain scene after playback. Press COUNTER RESET on the remote control to set the counter to "0:00:00" before playing a tape. The tape counter is automatically reset to zero whenever a cassette is inserted. The video TV keeps counting the length of the tape being played. Note, however, that the tape counter does not count the portions that do not contain any recordings.

# Recording TV programs

## Recording TV programs

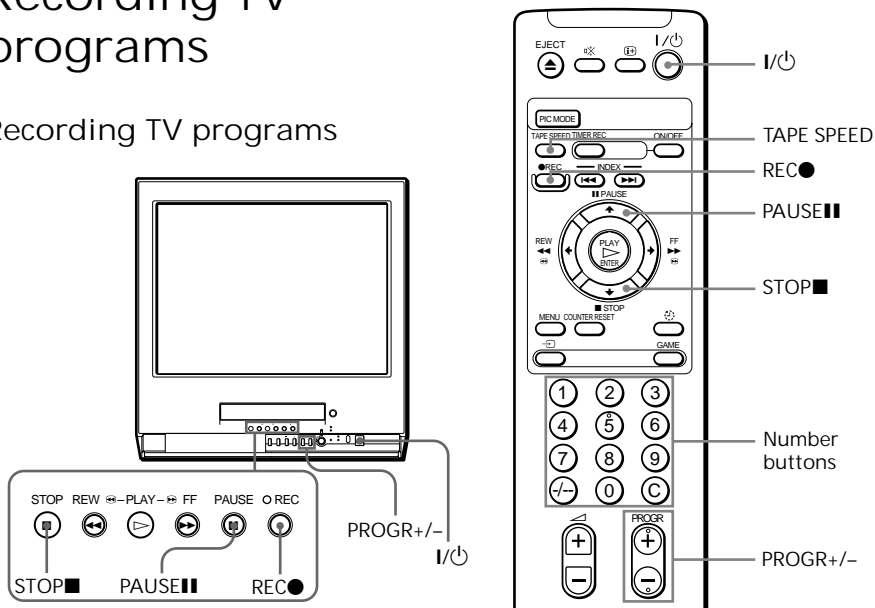

- 1 Press I/⏻ to turn on the video TV.  
If the TV is in standby mode (the ⏻ indicator on the video TV is lit in red), the video TV will turn on automatically when a cassette is inserted.

- 2 Insert a cassette with a safety tab.

- 3 Press PROGR+/- or the number buttons to select the program position.  
For double digit numbers, press -/-, then press the numbers (e.g., for 25, press -/-, then 2 and 5).

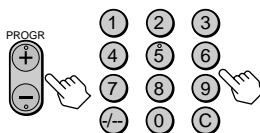

- 4 Press TAPE SPEED to select the tape speed.  
For details about the tape speed, see “Selecting the tape speed” on page 21.

TAPE SPEED



continued

---

## Recording TV programs (continued)

---

- 5 Press REC ●.  
The REC indicator lights up and recording begins.

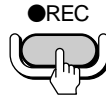

---

### Note

- You can also select the channel number directly with the number buttons. Press C (once for regular channels, twice for cable channels), the desired number buttons, then ENTER.

### To stop recording

Press STOP ■.

When the tape reaches the end, the video TV rewinds the tape automatically to the beginning, then stops. This function does not work when the power of the video TV is off.

### To pause recording

You can cut out an unwanted scene during recording with this button.

- 1 Press PAUSE ■■ when an unwanted scene appears on the screen. Recording pauses.
- 2 Press PAUSE ■■ again to release the pause mode at the end of the unwanted scene. Recording resumes from the point set in step 1.

When the recording pause mode lasts for about 5 minutes, the video TV stops recording to prevent tape damage.

### Recording with the TV off

Press I/⏻ on the video TV.

The video TV is turned off and the  indicator lights up. The video TV continues recording.

## Selecting the tape speed

The chart below shows the recording/playback time available in each mode.

### PAL, MESECAM

Cassette tape	Tape speed setting	
	SP mode	LP mode
E-30	30 min.	1 hr.
E-60	1 hr.	2 hrs.
E-90	1 hr 30 min.	3 hrs.
E-120	2 hrs.	4 hrs.
E-150	2 hrs 30 min.	5 hrs.
E-180	3 hrs.	6 hrs.
E-195	3 hrs 15 min.	6 hrs 30 min.
E-210	3 hrs 30 min.	7 hrs.
E-240	4 hrs.	8 hrs.

### NTSC

Cassette tape	Tape speed setting	
	SP mode	EP mode
T-30	30 min.	1 hr 30 min.
T-60	1 hr.	3 hrs.
T-120	2 hrs.	6 hrs.
T-160	2 hrs 40 min.	8 hrs.
T-180	3 hrs.	9 hrs.

### Notes

- In the SP mode, the tape runs twice as fast as the LP mode, and three times as fast as the EP mode.
- When a PAL format cassette is used with the NTSC system for recording, the actual recording time is shorter than the standard recording time stipulated on the cassette.

continued

## Recording TV programs (continued)

### Recording using QUICK-TIMER

The Quick-Timer recording function allows you to preset your video TV to record one program within a 24-hour period. For setting the Quick-Timer, use QUICK TIMER on the video TV.

Before you begin

- Make sure that the clock is set correctly. If it is not, see “Setting the clock” on page 9.
- Make sure that the loaded cassette has its safety tab intact.
- Make sure that the video TV does not enter the timer recording standby mode (the TIMER REC indicator on the video TV should not be lit.)

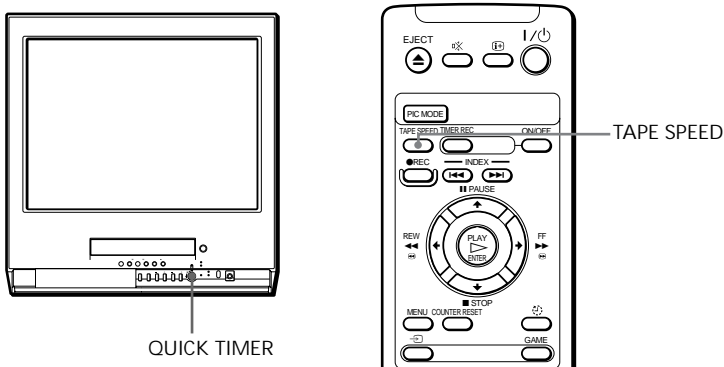

#### 1 Press QUICK TIMER.

When the TV is in standby mode (the  indicator on the video TV is lit in red), the power is turned on automatically.

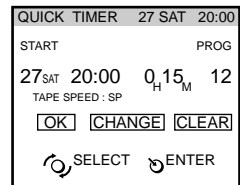
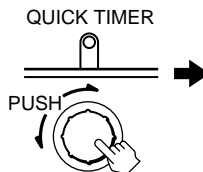

- #### 2 Press TAPE SPEED to select the tape speed, SP or LP. EP cannot be selected when making timer recordings.



- 
- 3 Turn QUICK TIMER to set the hour of the start time, then press QUICK TIMER.

The hour is set and the minute of the start time turns red.

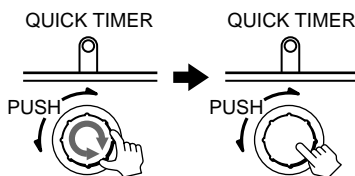

- 
- 4 Turn QUICK TIMER to set the minute of the start time, then press QUICK TIMER.

- 
- 5 Use the QUICK TIMER dial to set the recording time period and program position in the same way as in step 3.

- 
- 6 Turn QUICK TIMER to move the cursor to OK, then press QUICK TIMER.

The Quick Timer indicator lights up and the video TV enters the timer recording standby mode.

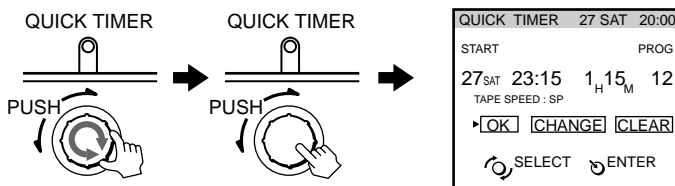



continued

---

## Recording TV programs (continued)

The QUICK TIMER button changes the following when turned clockwise or counterclockwise

- When setting the start time:
  - The hour increases or decreases by one hour.
  - The minutes increase or decrease by one minute.
- The recording time period:
  - Increases or decreases by 15 minutes.
- The program position changes as follows:  
1... ↔ 8... ↔ 12... ↔ 1 ↔ 2 ↔ 0 ↔ 1

If the QUICK TIMER button is pressed

- When the Quick Timer is not set:
  - The display for setting the Quick Timer appears.
- When the Quick Timer is set:
  - The display for checking the Quick Timer appears.
- When the clock is not set:
  - The CLOCK SET display appears.

Note

- When you turn QUICK TIMER to move the cursor to OK and then press it, one of the following messages may appear depending on the cassette used. If a message appears, the recording is canceled.
    - Put in a tape. The program recording is canceled.
    - Put in a tape with safety tab. The program recording is canceled.
    - Tape ran out. The program recording is canceled.
- Insert a cassette for recording, rewind the tape and press QUICK TIMER again.



## Changing or canceling the Quick Timer settings

- 1 Press QUICK TIMER.  
The QUICK TIMER display appears.

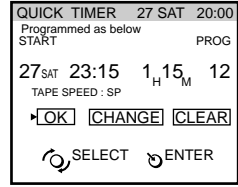
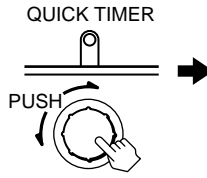

- 2 Change the settings:
- (1) Turn QUICK TIMER to move the cursor to CHANGE, then press QUICK TIMER.
  - (2) Change the settings according to steps 2 through 7 of "Recording using QUICK-TIMER" on pages 22 and 23.

To cancel the Quick Timer settings

Turn QUICK TIMER to move the cursor to CLEAR, then press QUICK TIMER.

Note

- You cannot cancel the Quick Timer settings with the remote control.

continued

## Recording TV programs (continued)

### Recording TV programs using the timer

You can preset up to five programs within a one-month period.

Before you begin

- When the TV is in standby mode (the  $\text{I}/\text{O}$  indicator on the video TV is lit in red), press  $\text{I}/\text{O}$ ,  $\text{PROGR} +/-$  or a number button on the remote control.
- Make sure that the clock is set correctly. If it is not, see “Setting the clock” on page 9.
- Make sure that the loaded cassette has its safety tab intact.
- Make sure that the video TV does not enter the timer recording standby mode (the Quick Timer indicator on the video TV should not be lit.)

#### Setting the timer

Example: How to record a program broadcast on program position 6 from 21:00 to 22:00 on Sunday, 28th November 1999.

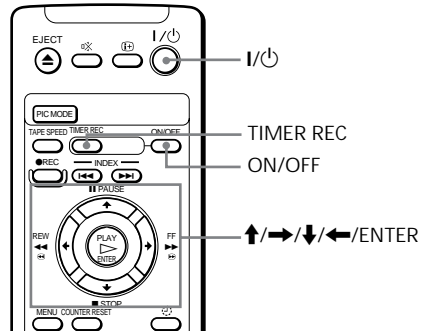

1 Press **TIMER REC.**

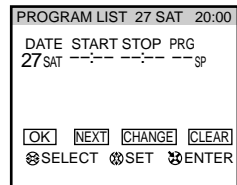
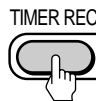

2 Press  $\uparrow$  or  $\downarrow$  to set the date, then press  $\rightarrow$ .

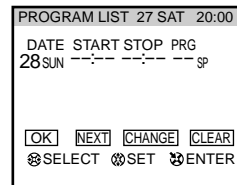
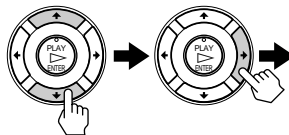

---

3 Set the recording start time, recording stop time, program position/input (1 or 2) and tape speed in the same way as in step 2.

---

4 Press ENTER.  
The cursor appears at OK.  
For daily and weekly recording, see "Daily/weekly recording" below.

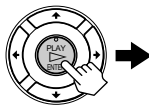

---

5 Press ← or → to move the cursor to NEXT for other programs, then press ENTER. Repeat steps 2 through 4.

---

6 Press ← or → to move the cursor to OK after setting your desired programs, then press ENTER.  
The **TIMER REC** indicator lights up and the video TV enters timer recording standby mode.

---

If you have made a mistake during timer setting

Press ← to go back to the previous position and correct the setting.

### Daily/weekly recording

You can preset your video TV to record the same program every day of the week (daily recording) or the same program on the same day every week (weekly recording). Press ↓ in step 2 until the desired setting appears in the "DATE" position. With each press, the setting changes as follows:

27 (today) → MON-SUN → MON-SAT → MON-FRI →  
EVERY SAT → EVERY FRI → ... → EVERY SUN → 26 (next month) .....

To stop timer recording

Press ON/OFF.

Using the video TV before timer recording starts

Press ON/OFF to turn off the **TIMER REC** indicator on the front of the video TV.

Remember to press ON/OFF again to make the **TIMER REC** indicator light up after setting the recording time.

continued

## Recording TV programs (continued)

Checking/adding/  
changing/canceling  
the timer settings

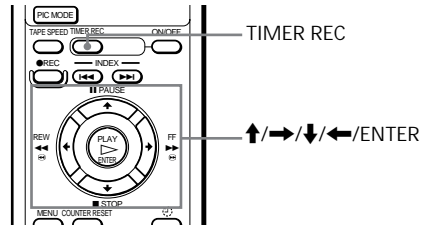

- 1 Press **TIMER REC**.  
To exit the **PROGRAM LIST** after checking the settings, skip steps 2 and 3.  
To add, change or clear the settings, follow steps 2 through 4.

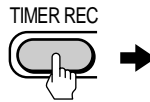

PROGRAM LIST 27 SAT 20:00				
Programmed as below				
DATE	START	STOP	PRG	
28 SUN	21:00	22:00	6 SP	
29 MON	1:30	3:00	79 LP	
MON-SAT	18:50	19:00	→2 SP	
EVERY TUE	21:00	23:30	→1 LP	

▶OK   ADD   CHANGE   CLEAR  
⊗SELECT   ⊗SET   ⊗ENTER

- 2 Press **←** or **→** to move the cursor to **ADD**, **CHANGE** or **CLEAR**, then press **ENTER**.

- 3 To add new settings  
Follow steps 2 through 4 of “Setting the timer” on page 26.

To change the settings

Press **↑** or **↓** to move the cursor to the setting you want to change, then press **ENTER**.

Follow steps 2 through 4 of “Setting the timer” on page 26.

To clear the settings

Press **↑** or **↓** to move the cursor to the setting you want to clear, then press **ENTER**.

The setting is cleared and “-” appears.

- 4 Press **←** or **→** to move the cursor to **OK**, then press **ENTER**.  
If there are other timer settings on the list, the video TV enters the timer recording standby mode and the **TIMER REC** indicator lights up. The **PROGRAM LIST** disappears.

When the timer settings overlap

The second program starts recording only after the first program has finished.

## Adjusting the TV

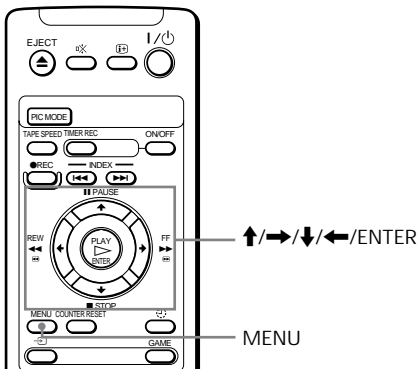

### Adjusting the volume — INTELLIGENT VOL

Some programs are broadcast at different volume levels. By setting this function to ON, the volume level is stabilized and sudden changes in volume can be prevented.

- 1 Press MENU.
- 2 Press **↑** or **↓** to select , then press ENTER.
- 3 Make sure TV SET UP is selected, then press ENTER.

- 4 Press **↑** or **↓** to select INTELLIGENT VOL, then press ENTER.  
The selected item turns red.

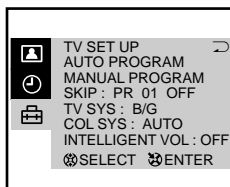
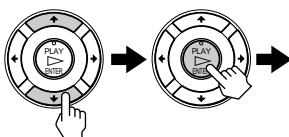

- 5 Press **↑** or **↓** to select ON, then press ENTER.

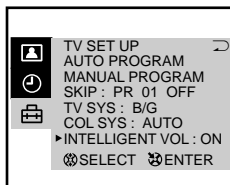
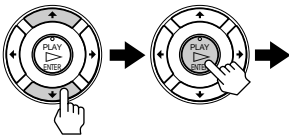

To return to the normal screen  
 Press MENU.

continued

## Adjusting the TV (continued)

### Presetting channels manually

Preset the channels manually if you want to select channels that were not set automatically or if you want to allocate program numbers to channels one by one.

---

1 Press MENU.

---

2 Press **↑** or **↓** to select , then press ENTER.

---

3 Make sure TV SET UP is selected, then press ENTER.

---

4 Press **↑** or **↓** to select MANUAL PROGRAM, then press ENTER.

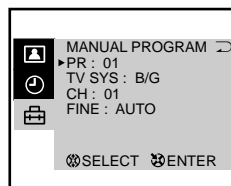
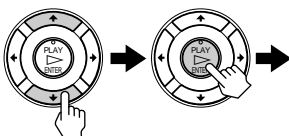

---

5 Select the program number to which you want to assign a channel number.

(1) Make sure PR is selected, then press ENTER.

(2) Press **↑** or **↓** until the program number you want to preset appears on the menu, then press ENTER.

You can also select the program number with the **PROGR +/-** or number buttons.

---

6 Select the desired channel.

(1) Press **↑** or **↓** to select CH, then press ENTER.

(2) Press **↑** or **↓** until the desired channel number appears on the menu, then press ENTER.

You can also select the channel number directly with the number buttons.

Press **C** (once for regular channels, twice for cable channels), the desired number buttons, then ENTER.

---

**7** If the sound of the desired channel is abnormal, select the appropriate TV system.

- (1) Press **↑** or **↓** to select TV SYS, then press ENTER.
- (2) Press **↑** or **↓** until the sound becomes normal, then press ENTER.

**8** If you are not satisfied with the picture and sound quality, you may be able to improve them by using the FINE tuning feature.

(1) Press **↑** or **↓** to select FINE, then press ENTER.  
The selected item turns red.

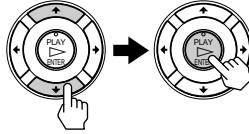

(2) Press **↑** or **↓** to select MANUAL, then press ENTER.

(3) Press **↑** or **↓** until the picture and sound quality are optimal, then press ENTER.

FINE tuning can be set between -15 and +15.

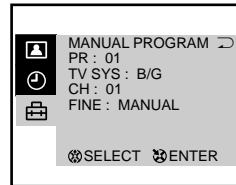
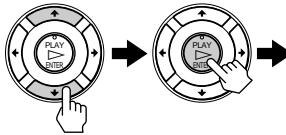

To return to the normal screen  
Press MENU.

continued

## Adjusting the TV (continued)

### Skipping program positions

You can skip unused program positions when selecting a program with the PROGR +/- buttons. However, the skipped programs may still be called up when you select them with the number buttons.

- 1 Press MENU.
- 2 Press **↑** or **↓** to select , then press ENTER.
- 3 Make sure TV SET UP is selected, then press ENTER.
- 4 Press **↑** or **↓** to select SKIP, then press ENTER.
- 5 Press **↑** or **↓** until the program position which you want to skip appears on the menu, then press ENTER.
- 6 Press **↑** or **↓** to select ON, then press ENTER.

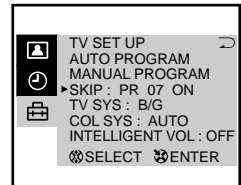
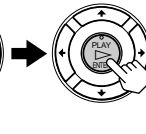

- 7 Press ENTER and repeat steps 5 and 6 to skip other program positions.

To return to the normal screen

Press MENU.



## Adjusting the TV system

If the sound of some channels is abnormal, select the appropriate TV system for your area.

- 1 Press MENU.
- 2 Press **↑** or **↓** to select , then press ENTER.
- 3 Make sure TV SET UP is selected, then press ENTER.
- 4 Press **↑** or **↓** to select TV SYS, then press ENTER.
- 5 Press **↑** or **↓** until the appropriate TV system appears on the menu, then press ENTER.

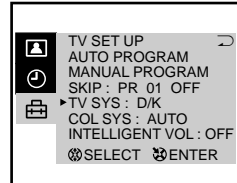
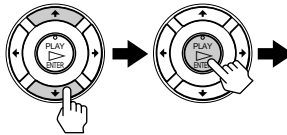

To return to the normal screen  
Press MENU.

continued

## Adjusting the TV (continued)

### Adjusting the color system

Normally set the color system to AUTO. However, when the picture has no color, manually select the appropriate color system for your area.

- 1 Press MENU.
- 2 Press **↑** or **↓** to select , then press ENTER.
- 3 Make sure TV SET UP is selected, then press ENTER.
- 4 Press **↑** or **↓** to select COL SYS, then press ENTER.
- 5 Press **↑** or **↓** until the appropriate color system appears, then press ENTER.

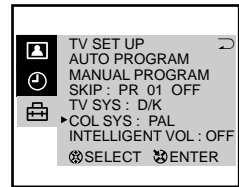
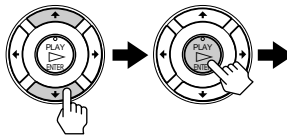

To return to the normal screen

Press MENU.

# Changing the PICTURE MODE setting

The PICTURE MODE menu allows you to adjust the picture quality.

1 Press MENU.

2 Press **↑** or **↓** to select **▲** , then press ENTER.

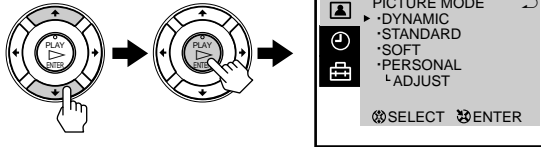

3 Press **↑** or **↓** to select ADJUST , then press ENTER.

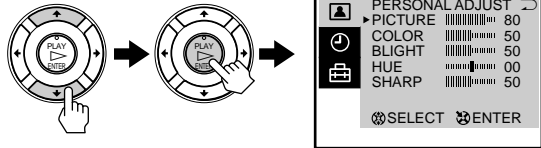

4 Press **↑** or **↓** to select the desired item, then press ENTER.  
The adjustment bar for the selected item appears at the bottom of the screen.

5 Adjust the value according to the following table, then press ENTER.

For	Press <b>↓</b> to	Press <b>↑</b> to
PICTURE	decrease picture contrast	increase picture contrast
COLOR	decrease color intensity	increase color intensity
BRIGHT	darken the picture	brighten the picture
HUE*	increase red picture tones	increase green picture tones
SHARP	soften the picture	sharpen the picture

\*You can adjust HUE for the NTSC color system only.

To return to the normal screen  
Press MENU.

continued

## Adjusting the TV (continued)

### Adjusting the alignment of the picture

The picture may be out of alignment due to influence from the earth's magnetic field in relation to the position of the TV. You can adjust the angle of the picture if it is not aligned to the TV screen.

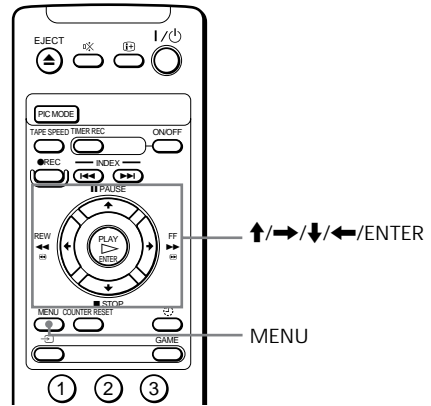

- 1 Press MENU.
- 2 Press  $\uparrow$  or  $\downarrow$  to select , then press ENTER.
- 3 Press  $\uparrow$  or  $\downarrow$  to select PIC ROTATION, then press ENTER.

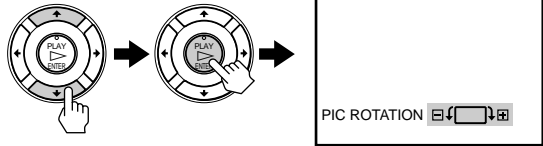

- 4 Press  $\uparrow$  or  $\downarrow$  to align the picture's position, then press ENTER.

# Tape options

## Adjusting the tracking

### Adjusting the tracking automatically

The tracking condition is automatically adjusted when this function is set to AUTO.

### Adjusting the tracking manually

If streaks or snow noise appear during normal playback, adjust the tracking.

1 Press MENU in playback mode.

2 Press **↑** or **↓** to select , then press ENTER.

3 Press **↑** or **↓** to select VIDEO SET UP, then press ENTER.

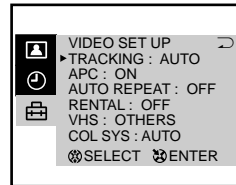
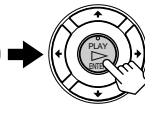

4 Make sure TRACKING is selected, then press ENTER.

5 Press **↑** or **↓** to select MANUAL, then press ENTER.

The tracking meter appears on the screen.

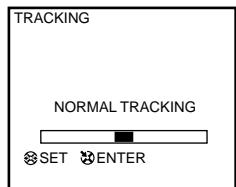
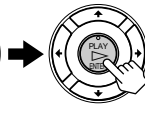

6 Press **←** or **→** to reduce picture noise, then press ENTER.

To return to the normal screen

Press MENU.

continued

## Tape options (continued)

### Adjusting with Adaptive Picture Control (APC)

This function allows you to improve playback and recording quality automatically according to the condition of the video tape.

This function is set to ON at the factory. To maintain better picture quality, it is advisable to leave the function on. The APC function works on all types of tapes, even on rental tapes.

To change the setting

- 1 Press MENU.
- 2 Press **↑** or **↓** to select , then press ENTER.
- 3 Press **↑** or **↓** to select VIDEO SET UP, then press ENTER.

- 4 Press **↑** or **↓** to select APC, then press ENTER.  
The selected item turns red.

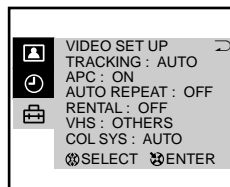
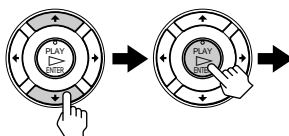

- 5 Press **↑** or **↓** to select OFF, then press ENTER.

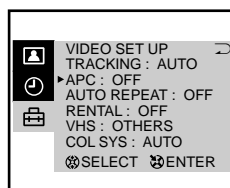
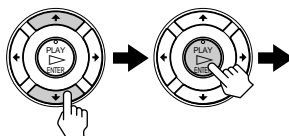

To return to the normal screen

Press MENU.

## Playing a tape repeatedly

You can play the recorded portion of a tape repeatedly.

1 Press MENU.

2 Press **↑** or **↓** to select , then press ENTER.

3 Press **↑** or **↓** to select VIDEO SET UP, then press ENTER.

4 Press **↑** or **↓** to select AUTO REPEAT, then press ENTER.

The selected item turns red.

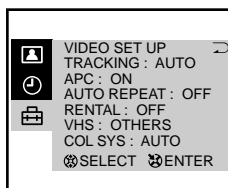
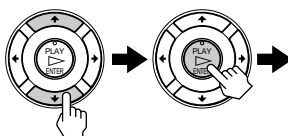

5 Press **↑** or **↓** to select ON, then press ENTER.

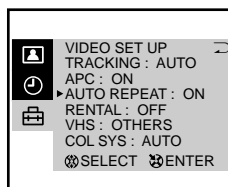
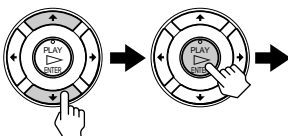

6 Press MENU to return to the normal screen.

7 Press PLAY .

Playback starts. When the tape reaches its end, the video TV rewinds the tape to the beginning, then plays it again.



continued

## Tape options (continued)

### Adjusting the picture for rental tapes

If you are not satisfied with the picture quality while playing a tape, even when APC is on, set RENTAL to ON. It is recommended to use this function when watching rental tapes.

- 1 Press MENU.
- 2 Press **↑** or **↓** to select , then press ENTER.
- 3 Press **↑** or **↓** to select VIDEO SET UP, then press ENTER.

- 4 Press **↑** or **↓** to select RENTAL, then press ENTER.  
The selected item turns red.

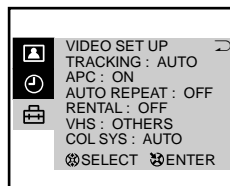
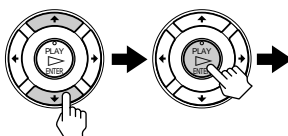

- 5 Press **↑** or **↓** to select ON, then press ENTER.

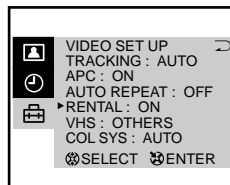
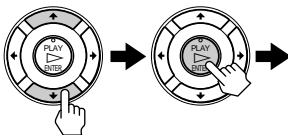

To return to the normal screen

Press MENU.



## When connecting to a Sony VCR

If you use this video TV with another Sony VCR, the remote control may accidentally operate both the video TV and VCR at the same time. To prevent this from happening, set VHS to SONY so that the remote control operates only this video TV.

- 1 Press MENU.
- 2 Press **↑** or **↓** to select , then press ENTER.
- 3 Press **↑** or **↓** to select VIDEO SET UP, then press ENTER.

- 4 Press **↑** or **↓** to select VHS, then press ENTER.  
The selected item turns red.

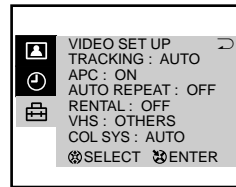
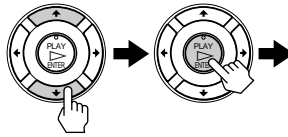

- 5 Press **↑** or **↓** to select SONY, then press ENTER.

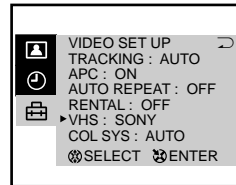
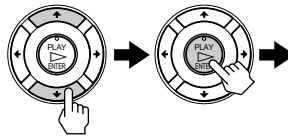

To return to the normal screen  
Press MENU.

continued

---

## Tape options (continued)

### Setting the color system

Normally set COL SYS in the menu to AUTO. If streaks appear during playback, set COL SYS to correspond to the system that the tape was recorded in.

- 
- 1 Press MENU.

---

  - 2 Press **↑** or **↓** to select , then press ENTER.

---

  - 3 Press **↑** or **↓** to select VIDEO SET UP, then press ENTER.

---

  - 4 Press **↑** or **↓** to select COL SYS, then press ENTER.

---

  - 5 Press **↑** or **↓** until the corresponding color system appears, then press ENTER.

Select the same color system that the tape was recorded in.

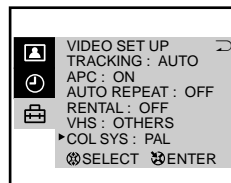
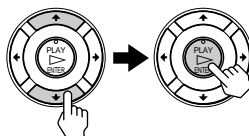

---

To return to the normal screen

Press MENU.

# Switching off automatically —SLEEP

You can automatically switch the video TV into standby mode after a selected time period.

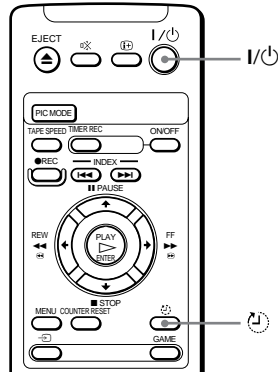

Press .

With each press, the time period (in minutes) changes as illustrated.

One minute before the TV switches into standby mode, the message “SLEEP TIMER: 1M” is displayed on the screen.



To cancel the timer

Press  to select OFF or press I/OFF to turn on the power.

# Switching on automatically — ON TIMER

You can preset your video TV to automatically switch on at a desired time. You can select the TV program, video playback or input source to be switched on.

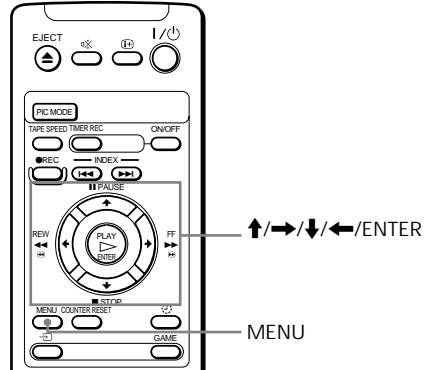

- 1 Press MENU.
- 2 Press ↑ or ↓ to select ⌚, then press ENTER.
- 3 Make sure ON TIMER SET is selected, then press ENTER.
- 4 Make sure that the cursor appears at DAY, then press ENTER.  
The selected item turns red.

- 5 Press ↑, ↓, ← or → to set the timer on (✓) or off (-) for each day of the week.

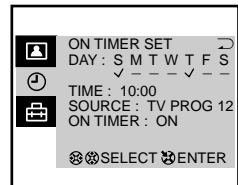
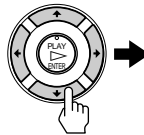

- 6 Press ↑ or ↓ to select TIME, then press ENTER.
- 7 Press ↑ or ↓ to set the on-time hour and minute, then press ENTER.
- 8 Press ↑ or ↓ to select SOURCE, then press ENTER.

---

**9** Press **↑** or **↓** to set the source to be switched on, then press ENTER.

The SOURCE changes as follows.

TV PROG → VCR ► (video playback)



If you select TV PROG, press **↑** or **↓** to change the channel numbers.

---

**10** Press **↑** or **↓** to select ON TIMER, then press ENTER.

---

**11** Press **↑** or **↓** to set ON TIMER to ON, then press ENTER.

---

**12** Press MENU to return to the normal screen.

The  indicator on the video TV lights up.

To cancel the on-timer function

In step **11**, press **↑** or **↓** to set ON TIMER to OFF, then press ENTER.

The  indicator on the video TV turns off.

# Searching using the index function

The video TV marks the tape with an index signal at the point where each recording begins. Use these signals as references to find a specific recording. This video TV can search up to 99 index signals ahead of or behind the current position.

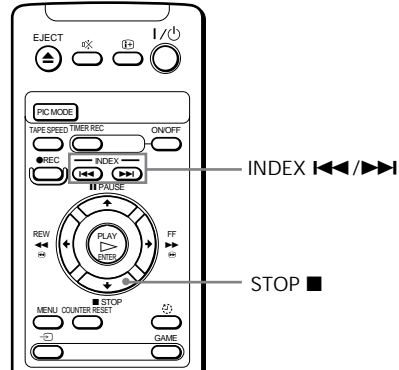

1 Insert an indexed tape.

2 Press INDEX repeatedly to specify how many index signals ahead or behind you want to search.

To search ahead, press INDEX .

To search backwards, press INDEX .

The video TV starts searching and the index number on the TV screen counts down to zero. Playback starts automatically from that point.

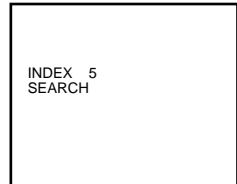
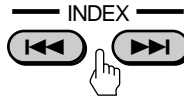

To stop searching

Press STOP .

# Connecting optional equipment

Watching and recording the picture input from optional equipment

To connect a video camera

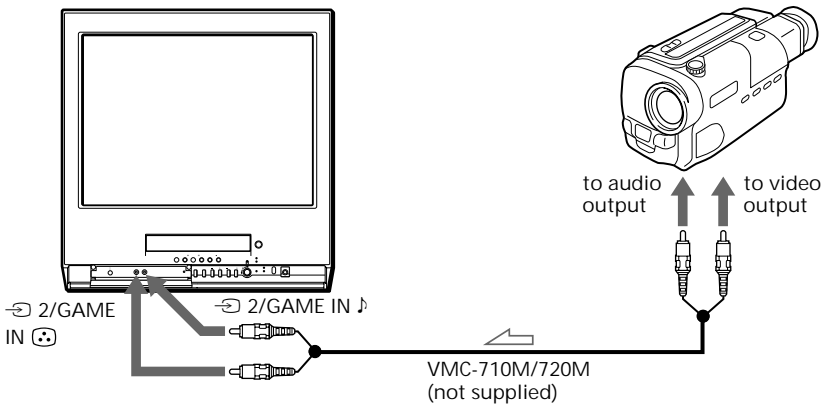

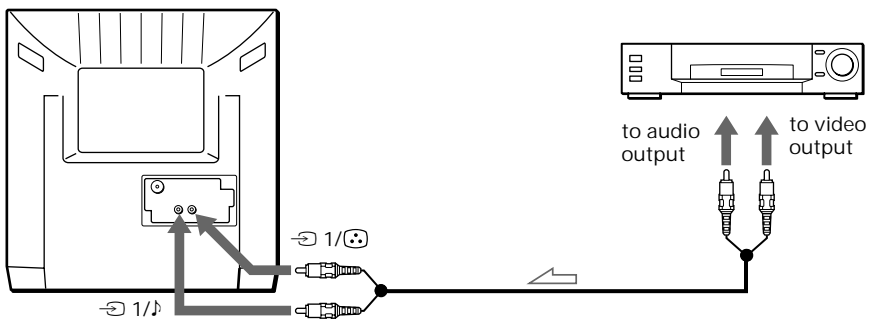

To connect a VCR



continued

## Connecting optional equipment (continued)

To watch the video input signal

Press  so that  or  appears on the screen.

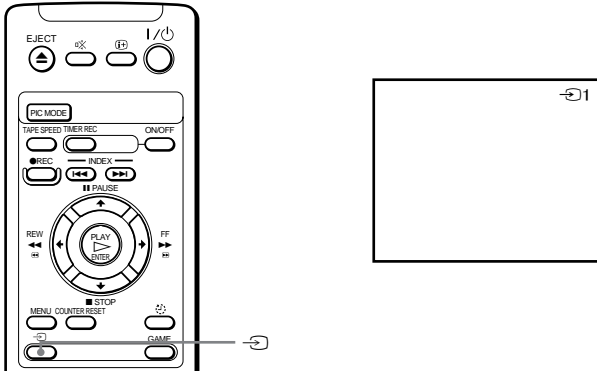



To connect a video game

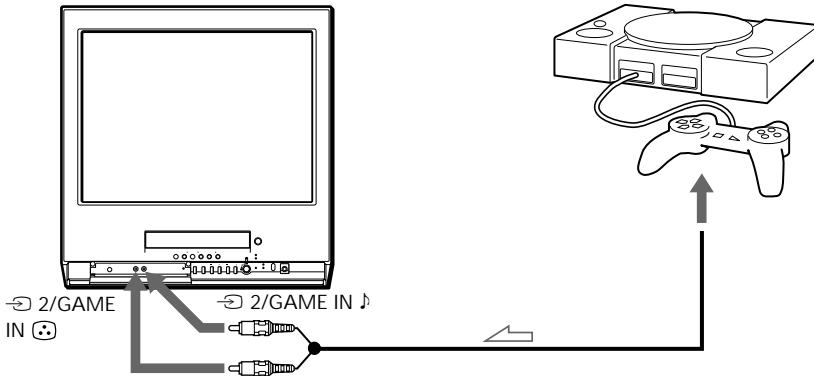

To display the video game screen

Press GAME when the video TV is in standby mode.

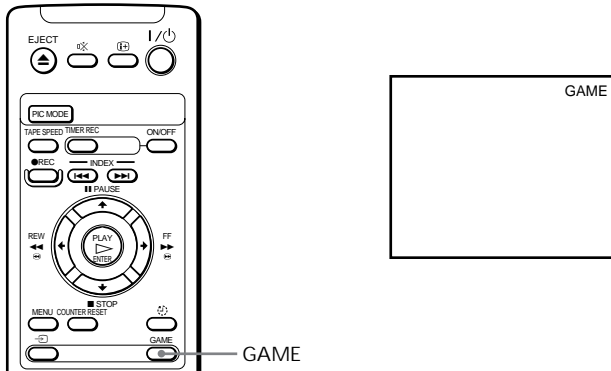

To switch to a TV program

Press the number button on the remote control, **PROGR +/-** or **↔** on the video TV or remote control.



To switch to the VCR

Press the **PLAY ▶** button on the video TV or remote control when a cassette is in the video TV.

# Self-diagnosis function

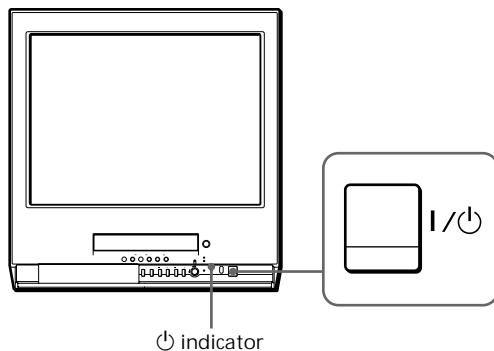
Your video TV is equipped with a self-diagnosis function. If there is a problem with your video TV, the  indicator flashes in red. The number of times the indicator flashes indicates the possible causes.





- 1 Check that the  indicator flashes red once or more in intervals of 3 seconds.
- 2 Count the number of times the indicator flashes.
- 3 Press  to turn off your video TV.
- 4 Inform your nearest Sony service facility about the number of times the indicator flashes.

**Be sure to note the model name and serial number located on the rear of your video TV.**

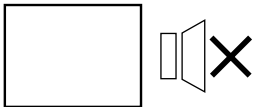
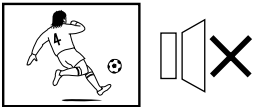

# Troubleshooting

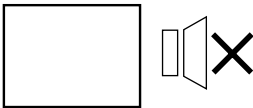
If you have any problems while viewing your video TV, please check the following troubleshooting guide. If the problem persists, contact your Sony dealer.

Symptom	Possible cause	Solutions
<b>TV section</b>		
No picture/No sound 	The power cord or antenna is not connected.	Check the AC power cord and the antenna connections.
	The video TV is not turned on.	Press I/⏻ on the video TV. If the standby indicator (⏻) is lit in red, press I/⏻ or a program number button on the remote control.
Good picture/No sound 	The volume level is too low.	Press ◀ + to increase the volume level.
	The sound is muted.	Press ⓧ to cancel the muting.
	Headphones are connected to Ⓜ (headphones) jack.	Disconnect the headphones.
No color or poor color 	The color level setting is too low.	Adjust PICTURE, COLOR and BRIGHT in the PERSONAL ADJUST menu. (page 35)
	The picture setting is inappropriate.	Press PIC MODE to switch the picture setting. (page 15)
	The color system setting is inappropriate.	Display the TV SET UP menu and check the color system (COL SYS) setting. (page 34)
	The antenna direction, position and angle need adjustment.	Adjust the antenna direction, position and angle. Contact a Sony dealer for advice.
Double images or "ghosts" 	Broadcast signals are reflected by nearby mountains or buildings.	Use a highly directional antenna.
	The antenna direction, position and angle need adjustment.	Adjust the antenna direction, position and angle. Contact a Sony dealer for advice.
No picture/No sound from video input sources 	The connecting cord between the video TV and the input sources is disconnected.	Check the connection between the video TV and the input sources.
	Input is not selected correctly.	Press ⏪ so that "⏪1" or "⏪2" appears. (page 48)

continued

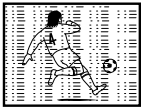
## Troubleshooting (continued)

Symptom	Possible cause	Solutions
<p>Good picture/Abnormal sound</p> 	The TV system setting is inappropriate.	<ul style="list-style-type: none"> <li>• If the sound of all the channels is abnormal, display the TV SET UP menu and select the appropriate TV system (TV SYS), then preset the channels again. (pages 11 and 12)</li> <li>• If the sound of some channels is abnormal, display the MANUAL PROGRAM menu in the TV SET UP menu and select the appropriate TV system (TV SYS) (page 30).</li> </ul>
<p>Snowy picture/Abnormal sound</p> 	The connection is loose or the cable is damaged.	Check the antenna cable and connection on the video TV and at the wall.
	The channel presetting is inappropriate or incomplete.	Display the TV SET UP menu and select MANUAL PROGRAM to manually preset the channel again.
	The antenna type is inappropriate.	Check the antenna type (VHF/UHF). Contact a Sony dealer for advice.
	The antenna direction, position and angle need adjustment.	Adjust the antenna direction, position and angle. Contact a Sony dealer for advice.
<p>Dotted lines or stripes</p> 	There is local interference from cars, neon signs, hair dryers, power generators, etc.	<ul style="list-style-type: none"> <li>• Do not use a hair dryer or other equipment near the video TV.</li> <li>• Adjust the antenna direction, position and angle for minimum interference. Contact a Sony dealer for advice.</li> </ul>
<p>Abnormal color patches</p> 	There is magnetic disturbance from external speakers or other equipment.	Locate external speakers or other equipment away from the video TV. Press I/⏻ on the video TV to turn off the video TV for about five minutes, then turn on again.
<p>Clock and timer section</p>		
<p>The clock has stopped and "--:--" is displayed.</p>	The power has been interrupted or the AC power cord is disconnected.	Re-set the clock and timer settings. (page 9)

Symptom	Possible cause	Solutions
<b>Playback section</b>		
Power is on, but the tape does not run.	The safety device has been activated.	Switch off, disconnect the AC power cord, and leave the set for about one minute.
Poor playback picture 	The color system setting is inappropriate.	Display VIDEO SET UP and set the color system (COL SYS) to the setting corresponding to the color system that the tape is recorded in. (page 42)
	The tracking condition is inappropriate.	Adjust the tracking manually. (page 37)
	The video heads are dirty.	Clean the video heads using the Sony T-25CLD, T-25CLDR, or T-25CLW video head cleaning cassette (not supplied). If these cleaning cassettes are not available in your area, have the heads cleaned at your nearest Sony service facility (a standard service fee will be charged). Do not use any commercially available liquid type cleaning cassettes other than Sony's, as it may damage the video heads.
	The video heads may be worn out.	The video heads may have to be replaced. Contact a Sony dealer for advice.
	The tape is worn out.	Use a new tape.
The sound drops out.	The tape is defective.	Use a new tape.

### Symptoms caused by contaminated video heads

- Normal picture
- Rough picture
- Unclear picture
- No picture (or black & white screen appears)

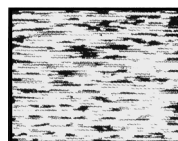

initial contamination → terminal

continued

## Troubleshooting (continued)

Symptom	Possible cause	Solutions
Recording section		
The cassette is ejected when you press REC ●.	The safety tab of the cassette has been removed.	Cover the safety tab hole with adhesive tape, or use another cassette with its safety tab intact.
Cannot record.	No cassette has been inserted.	Insert a cassette with its safety tab intact.
	The tape is at its end.	Rewind the tape.
Timer recording section		
Cannot program a recording using the timer.	The clock has not been set.	Set the current time and date. (page 9)
The cassette is ejected when you press ON/OFF.	The safety tab of the cassette has been removed.	Cover the tab hole with adhesive tape, or use another cassette with its safety tab in place.
The TIMER REC indicator does not light up even though you press ON/OFF.	No cassette has been inserted.	Insert a cassette with its safety tab intact.
	The tape is at its end.	Rewind the tape.
	No setting is made for timer recording.	Set the program for timer recording. (pages 26 through 27)
Timer recording was not made.	<ul style="list-style-type: none"> <li>You did not press ON/OFF.</li> <li>There has been a power interruption.</li> </ul>	—
Others		
A cassette cannot be inserted.	Another cassette is already inserted.	Press EJECT ▲ to eject the cassette.
The remote control does not work.	The batteries are low.	Replace the batteries. (page 4)
	The batteries are installed incorrectly.	Install the batteries with correct polarities. (page 4)
TV cabinet creaks.	Changes in room temperature sometimes make the TV cabinet expand or contract, causing a noise. This does not indicate a malfunction.	—
A small “boom” sound is heard when the video TV is turned on.	The video TV’s demagnetizing function is working. This does not indicate a malfunction.	—

# Identifying parts and controls

Refer to the pages indicated in parentheses ( ) for details.

## Front panel

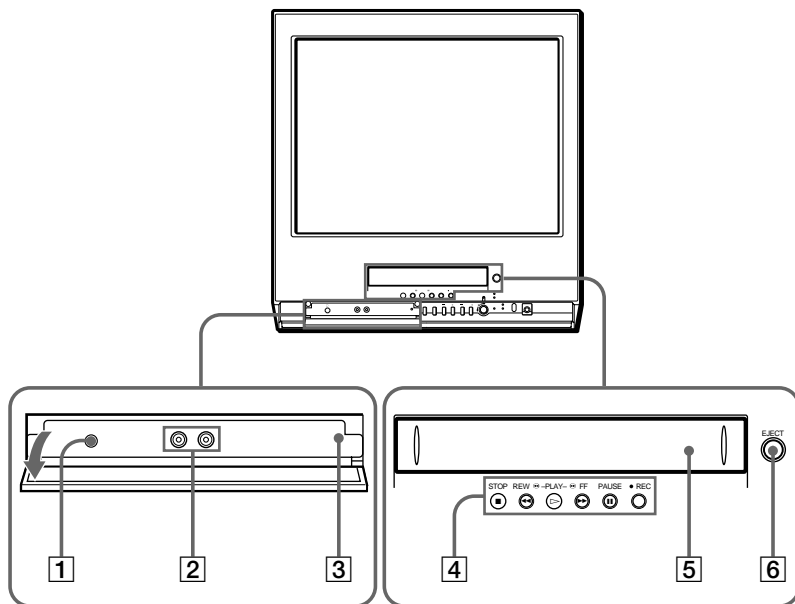





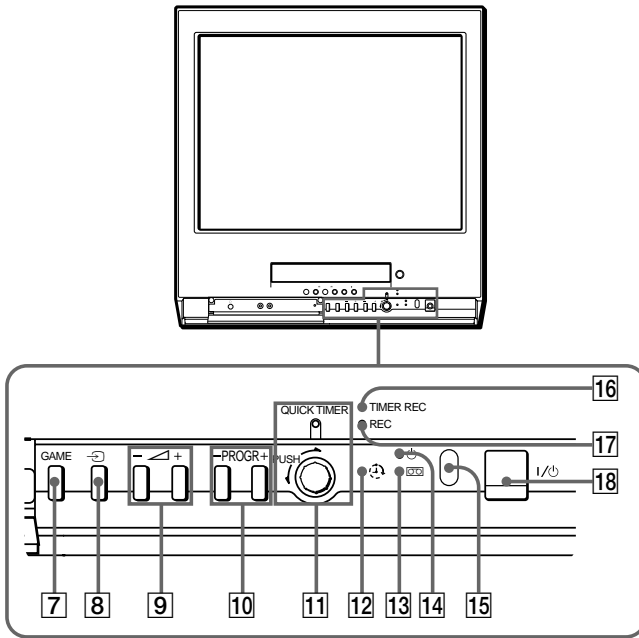

- 1** 🎧 (headphones) jack
- 2** 📺/GAME IN jacks (📺 (video)/🎵 (audio)) (47, 48)
- 3** TUNER PRESET ON/OFF button (12, 13)

- 4** Tape transport buttons  
STOP ■ button (17, 20)  
REW ◀/◀ button (17)  
PLAY ▶ button (17)  
FF ▶▶/▶▶ button (17)  
PAUSE || button (17, 20)  
REC ● button (20)
- 5** Cassette compartment
- 6** EJECT ▲ button (17)

continued

Identifying parts and controls (continued)



- 7** GAME button (13, 49)
- 8**  (input select) button (48)
- 9**  (volume) +/- buttons (15)
- 10** PROGR +/- buttons (14)
- 11** QUICK TIMER (22, 23)  
Indicator  
Rotary button
- 12**  (ON TIMER) indicator (44)
- 13**  (VCR) indicator (20)
- 14**  (standby) indicator (14)
- 15** Remote control sensor
- 16** TIMER REC (recording) indicator (27)
- 17** REC (recording) indicator (20)
- 18**  (power/standby) switch (14)



## Remote control

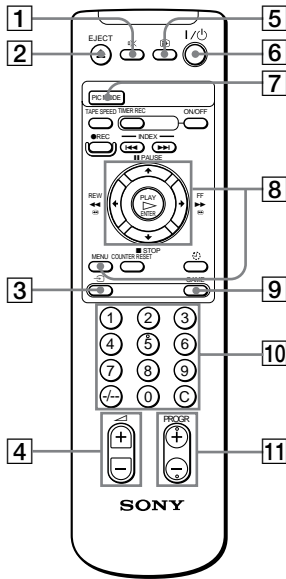

1 (muting) button (15)

2 button (17)

3 (input select) button (48)

4 (volume) +/- buttons (15)

5 (display) button (16, 18)

6 (power/standby) button (14)

7 (picture mode) button (15)

8 Menu operation buttons (26)

MENU button

buttons

ENTER button

9 button (49)

10 Number buttons (19)

11 (19)

continued

Identifying parts and controls (continued)

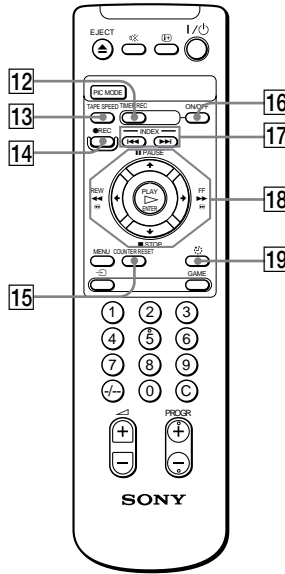

- 12** TIMER REC (recording) button (26)
- 13** TAPE SPEED button (19)
- 14** REC ● (recording) button (20)
- 15** COUNTER RESET button (18)
- 16** ON/OFF button (for timer recording) (27)
- 17** INDEX ◀◀/▶▶ button (46)
- 18** Tape transport buttons  
 PAUSE || button (17, 20)  
 REW ◀◀/◀ button (17)  
 STOP ■ button (17, 20)  
 FF ▶▶/▶ button (17)  
 PLAY ▶ button (17)
- 19** ⏰ (SLEEP TIMER) button (43)

# Specifications

TV Section		Inputs and Outputs	
Television system	B/G, I, D/K, M	Inputs	Ⓜ1, Ⓜ2/GAME IN Ⓜ (video): phono jack 1 Vp-p, 75 ohms, unbalanced, sync negative Ⓜ (audio): phono jack Input level: 500 mVrms
Color system	PAL/SECAM and NTSC <sup>3.58</sup> /NTSC <sup>4.43</sup>	Headphones jack	Minijack
Channel coverage	See "Receivable channels and channel display" on page 60	General	
Picture tube	Trinitron	Clock	Quartz locked
	21 inches (approx. 50.7 cm measured diagonally)	Power requirements	110-240 V AC, 50/60Hz
Antenna in	75-ohm antenna socket for VHF/UHF	Power consumption	123 W
Video Section		Operating temperature	5° C to 40° C (41° F to 104° F)
Format	VHS standard	Storage temperature	-20° C to 60° C (-4° F to 140° F)
Video recording system	Rotary 2-head helical scanning system	Dimensions	489 x 500 x 485 mm (19 <sup>3</sup> / <sub>8</sub> x 19 <sup>3</sup> / <sub>4</sub> x 19 <sup>1</sup> / <sub>8</sub> inches)
Audio recording system	Monaural	Mass	27.5kg (60 lb 10 oz.)
Video signal	PAL/MESECAM/ NTSC	Supplied accessories	See page 4.
Tape speed	PAL/MESECAM SP: 23.39 mm/sec. LP: 11.70 mm/sec. NTSC SP: 33.35 mm/sec. EP: 11.11 mm/sec.	Design and specifications are subject to change without notice.	
Maximum recording time	PAL/MESECAM SP: 240 minutes with E-240 LP: 480 minutes with E-240 NTSC SP: 180 minutes with T-180 EP: 540 minutes with T-180		

## Receivable channels and channel display

System	Area	Channel coverage	Channel display
B/G, H	Middle East/Asia	E-2 to E-12 E-21 to E-69	C02 to C12 C21 to C69
	Indonesia	1A 2 to 11	C01 C03 to C12
	Morocco	M-4 to M-7 M-8 to M-10	C70 to C73 C08 to C10
	CATV	S-01 to S-05 S-1 to S-41	S42 to S46 S01 to S41
I	Hong Kong/ United Kingdom	B-21 to B-69	C21 to C69
	Ireland	A, B, C,....J	C01 to C10
	South Africa	4 to 13 21 to 68	C04 to C13 C21 to C68
	Angola	1 2 to 3	C00 C02 to C03
	CATV	S-01 to S-05 S-1 to S41	S42 to S46 S01 to S41
D/K, K1	East European countries	R-1 to R-12 R-21 to R-60	C01 to C12 C21 to C60
	China	C-1	C01
		C-2	C02
		C-3	C13
		C-4	C03
		C-5	C04
		C-6	C14
C-7 to C-12 C-13 to C-24 C-25 to C-47 C-48 to C-57		C06 to C11 C21 to C32 C38 to C60 C61 to C70	
Ivory Coast	1 to 3	C71 to C73	
CATV	S-1 to S-39	S01 to S39	
M	America	A-2 to A-13 A-14 to A-69	C02 to C13 C14 to C69
		CATV	A-8 A-7 A-6 A-5 to A-1 A to E F to W+28 W+29 to W+58



