

# Video Cassette Recorder

## Operating Instructions

SLV-SP70R 

©1999 by Sony Corporation

### Getting Started

## Step 1

### Unpacking

Check that you have received the following items with the VCR:

- Remote commander

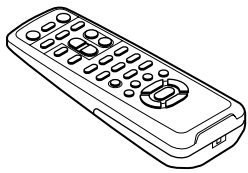

- Aerial cable

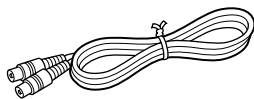

- R6 (Size AA) batteries

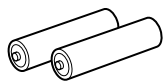

## Step 2

### Setting up the remote commander

#### Inserting the batteries

Insert two R6 (size AA) batteries by matching the + and - on the batteries to the diagram inside the battery compartment.

Insert the negative (-) end first, then push in and down until the positive (+) end clicks into position.

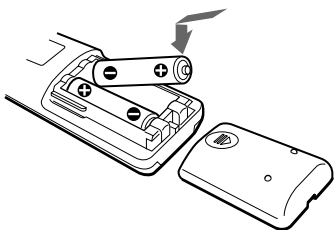

#### Using the remote commander

You can use this remote commander to operate the VCR and a Sony TV. To operate this VCR, point at the remote sensor on the VCR. To operate the TV, point at the remote sensor on the TV. Buttons in the shaded area of the remote commander can be used to operate your Sony TV. If the TV does not have the  symbol near the remote sensor, this remote commander will not operate the TV.

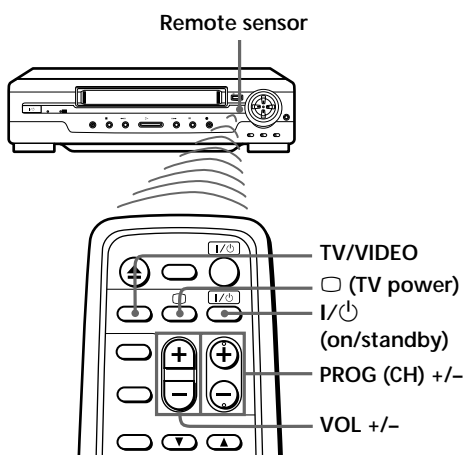

To	Press
Turn the TV to standby or active mode	I/O (on/standby)
Turn on the TV power	□ (TV power)
Increase (+) or decrease (-) the TV volume	VOL +/-
Change the TV programme position	PROG (CH) +/-
Select an input source of the TV either from aerial in or from line in	TV/VIDEO

#### Notes

- With normal use, the batteries should last about three to six months.
- If you do not use the remote commander for an extended period of time, remove the batteries to avoid possible damage from battery leakage.
- Do not use a new battery with an old one.
- Do not use different types of batteries.

## Step 3

### Connecting the VCR

Connect the aerial to your VCR and TV as shown below to watch TV programmes and video pictures on your TV. In addition, if your TV has audio/video (A/V) input jacks, we recommend you connect the VCR to your TV using an audio/video cable to get a better picture and sound.

- 2 Connect AERIAL OUT of the VCR and the aerial input of your TV using the supplied aerial cable.

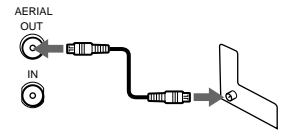

#### Connecting the aerial

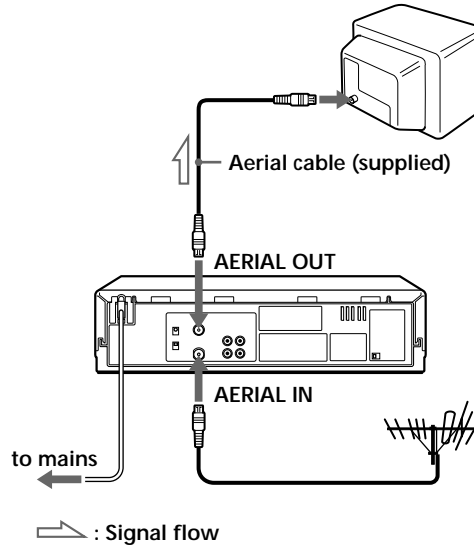

- 1 Disconnect the aerial cable from your TV and connect it to AERIAL IN on the rear panel of the VCR.

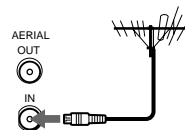

- 3 Connect the mains lead to the mains.

#### Additional connections

To a TV that has audio/video input jacks This additional connection improves picture and sound quality. Connect the TV as shown below.

If you want to use the Trinitron TV Synchro Play function, this connection is necessary. (If your TV has two or more inputs, connect the audio/video cable to the VIDEO IN 1 jacks.)

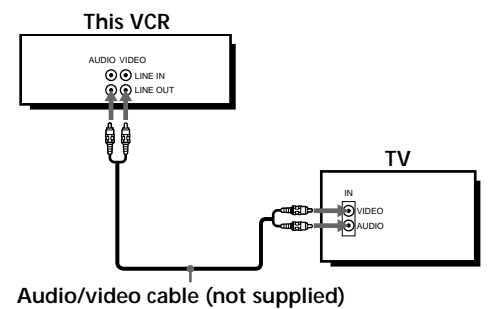

## Step 4

### Tuning your TV to the VCR

If you have connected your VCR to the TV using the audio/video cable, skip this step.

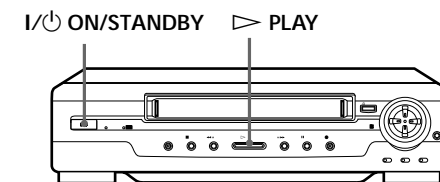

- 1 Press I/O ON/STANDBY to turn on the VCR.

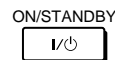

- 2 Turn on your TV and select a programme position for the video picture. This channel will now be referred to as the video channel.

Some TV has the programme position, such as 0, that is reserved for a VCR. In this case, select that programme position for the video picture. Refer to the instruction manual of your TV for details.

- 3 Tune the TV until the video picture below is clearly displayed on the TV screen.



Refer to your TV manual for tuning instructions.

You have now tuned your TV to the VCR. From now on, whenever you want to play a tape, set the TV to the video channel.

#### To obtain a clear playback picture

If the video picture does not appear clearly in step 3 above, turn the RF CHANNEL screw on the rear panel of the VCR with a screwdriver to a position where the TV clearly displays the playback picture.

#### To select the TV system

For your TV to receive the correct signal from your VCR you must set the TV SYSTEM switch on the rear panel of the VCR to either G (for system B/G) or K (for system D/K). If this switch is set to the wrong position, the sound will be distorted.

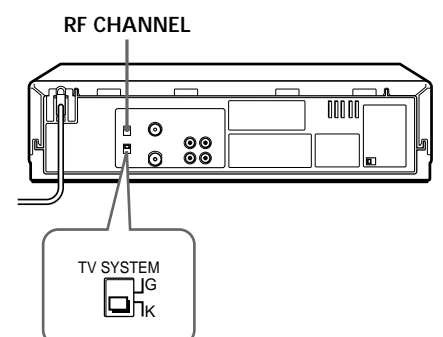

## Playing/searching at various speeds

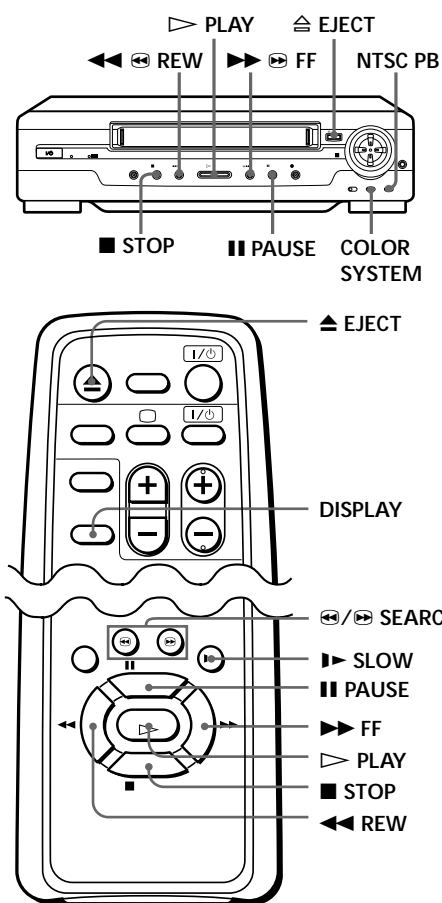

### To set the colour system

If streaks appear during playback, set COLOR SYSTEM on the VCR to conform to the system that the tape was recorded in. (Normally set the switch to AUTO.)

If your tape was recorded in	Set COLOR SYSTEM to
PAL	PAL/MESECAM
NTSC	NTSC
MESECAM	PAL/MESECAM

### To play an NTSC-recorded tape

Set NTSC PB on the VCR according to the colour system of your TV.

If your TV is	Set NTSC PB to
PAL	ON PAL TV
NTSC 4.43	NTSC 4.43
NTSC 3.58	NTSC 3.58

### To view the tape status on the screen

Press DISPLAY. The following information appears on the TV screen.

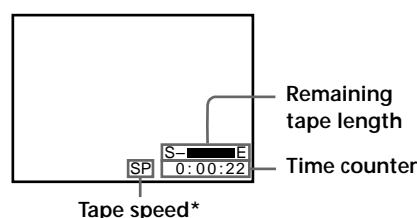

\* Appears for a few seconds when the DISPLAY button is pressed and when the mode is changed.

To turn the display off, press DISPLAY again.

### Notes

- The sound is muted during playback at various speeds and pause.
- You can eject a tape even when the power is off. When you press **EJECT**, the VCR turns on automatically. After ejecting the tape, the VCR turns off again.
- When the pause mode lasts for more than approximately five minutes, the VCR will automatically enter the playback mode.
- Tapes recorded in the LP mode of NTSC system on other VCRs can be played back on this VCR, but the picture quality cannot be guaranteed.
- The counter resets to "0:00:00" whenever a tape is inserted.
- The counter stops counting when it comes to a portion with no recording.
- If a tape has portions recorded in both PAL and NTSC systems, the time counter reading will not be correct. This is due to the difference between the counting cycles of the two colour systems.
- Streaks or snow cannot be eliminated completely in the various playback operations, especially in the slow motion mode.
- On screen symbols may shake while playing or searching at various speeds.
- Depending on your TV, the following may occur while playing an NTSC-recorded tape:
  - the picture is black and white,
  - the picture shakes,
  - no picture appears on the TV screen,
  - black streaks appear horizontally on the TV screen, and
  - the colour density increases or decreases.

1 Turn on your TV and set it to the video channel.

2 Insert a tape.

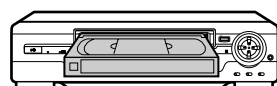

The VCR turns on and starts playing automatically if you insert a tape with its safety tab removed.

3 Press **PLAY** (if playback did not start in step 2).



When the tape reaches the end, it will rewind automatically.

### Additional tasks

Playback options	Operation
Stop play	Press <b>STOP</b> .
Pause play	Press <b>PAUSE</b> .
Resume play after pause	Press <b>PAUSE</b> or <b>PLAY</b> .
Fast-forward the tape	Press <b>FF</b> ( <b>FF</b> on the VCR) during stop.
Rewind the tape	Press <b>REW</b> ( <b>REW</b> on the VCR) during stop.
View the picture during fast-forward or rewind	During fast-forward, hold <b>FF</b> ( <b>FF</b> on the VCR) down. During rewind, hold <b>REW</b> ( <b>REW</b> on the VCR) down.
Play at high speed	<ul style="list-style-type: none"> <li>During playback or pause, press <b>SEARCH</b> or <b>SEARCH</b>.</li> <li>During playback or pause, hold down <b>FF</b> (<b>FF</b> on the VCR) or <b>REW</b> (<b>REW</b> on the VCR). When you release the button, normal playback resumes.</li> </ul>
Play in slow motion	During playback or pause, press <b>SLOW</b> .
Rewind and start play	During stop, press <b>PLAY</b> on the VCR while holding down <b>REW</b> on the VCR.
Eject the tape	Press <b>EJECT</b> .
Resume normal playback	Press <b>PLAY</b> .

## Turning on the VCR and TV to start playback (Trinitron TV Synchro Play)

You can only use this function if your TV is made by Sony (Trinitron TV).

### How to connect to use this function

Connect the VCR and TV with the audio/video cable. Be sure to connect the audio/video cable to the VIDEO IN 1 jacks on the TV if the TV has two inputs or more. The TV must be placed where it will respond to the remote commander while you are pointing it at the VCR.

### Operation

Make sure that the TV's power is in standby mode.

Press TRINITRON TV SYNCHRO PLAY and hold the remote commander in place for about two seconds.

The VCR and TV turn on, and the TV is set to the video channel. If there is a tape in the VCR, playback starts automatically.

### Notes

- If the Trinitron TV Synchro Play function does not work properly:
  - Wait a few moments, and press the button again.
  - Replace both of the batteries in the remote commander with new ones, and press the button again.
- Note that this function may not operate some Sony TVs because of the remote commander's signal limitations.
- Do not press TRINITRON TV SYNCHRO PLAY while playing back a video tape. If you do so, the TV's input source will momentarily switch to the TV's tuner.

## Adjusting the picture

Although the VCR automatically adjusts the picture when playing a tape, distortions or noise may occur if the tape was recorded in poor condition. If so, manually adjust the resolution, colour and tracking.

### Adjusting the tracking

Press **TRACKING NORMAL/SLOW** to obtain the best possible picture. The distortion should disappear as you press one of the two buttons. If you cannot get a clear picture with manual adjustment, press **TRACKING AUTO/MANU** to return to automatic adjustment.

### About Adaptive Picture Control (APC)

Adaptive Picture Control (APC) automatically improves recording and playback quality by adjusting the unit to the condition of the video heads and tape.

#### APC playback

The APC function automatically works on all types of tapes, including rental tapes and tapes that were not recorded with APC.

#### APC recording

Whenever you insert a tape and first start recording, the unit adjusts to the tape using the APC function. This adjustment is retained until the tape is ejected.

#### Tip

- Adjust the picture using **TRACKING NORMAL/SLOW/STILL ADJUST** if:
  - streaks appear while playing in slow motion
  - the picture shakes while pausing

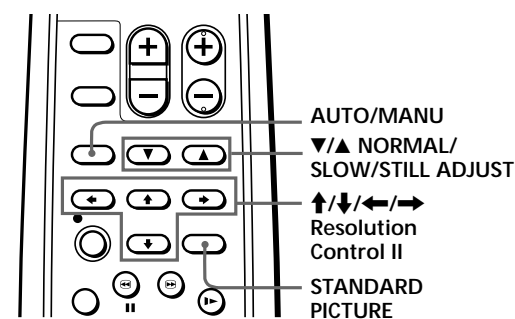
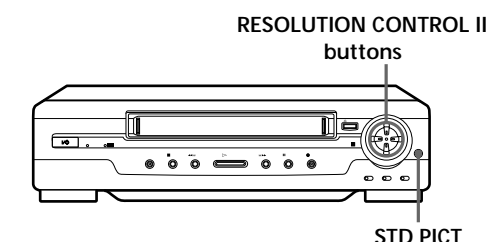

### Adjusting the resolution and colour

1 While playing a tape, press **RESOLUTION CONTROL II** (up/down/left/right button on the unit) to display the RESOLUTION CONTROL II menu.

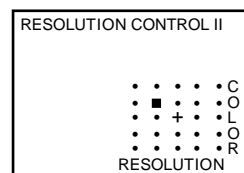

The RESOLUTION CONTROL II buttons light up.

2 Press **RESOLUTION CONTROL II** (left/right button on the unit) to get a clearer picture.

3 Press **RESOLUTION CONTROL II** (up/down button on the unit) to get the best picture colour. Wait for several seconds until the RESOLUTION CONTROL II menu disappears.

### To resume the automatic adjustment

Press STANDARD PICTURE on the remote commander (STD PICT on the unit) so that the RESOLUTION CONTROL II buttons turn off.

### Notes

- The auto tracking function works automatically when you play back a tape just after inserting it.
- There is a delay of a few seconds before the unit actually starts recording while the unit analyses the tape. To avoid the delay, first set the unit to recording pause and press **REC** to have the unit analyse the tape. After ten seconds, press **PAUSE** to start recording immediately. If you press **PAUSE** before ten seconds, the APC function is cancelled.
- While playing a MESECAM recorded tape, you cannot adjust the colour using the RESOLUTION CONTROL II function.
- Sufficient picture quality may not be obtained when playing back tapes recorded on another VCR or tapes in poor condition.
- When a tape recorded with the copyguard system is played back, intermittent distortion may appear in the upper portion of the picture. However, this is not a malfunction of the unit.

## Editing with another VCR

### How to connect to record on this VCR

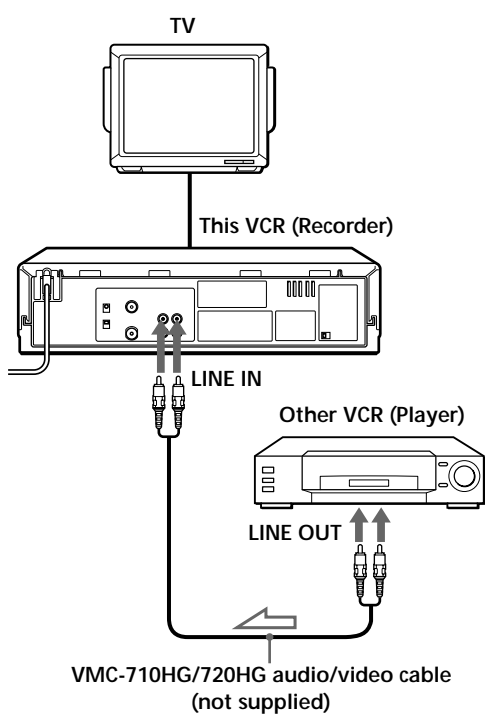

Signal flow

#### Tip

- Use a commercially available connecting cable such as the Sony VMC-710HG/720HG. If the other VCR has the AUDIO L and R jacks, use a connecting cable such as the Sony VMC-910HG (3-phono to 2-phono).

#### Notes

- Make sure you connect the plugs to jacks of the same colour.
- If you connected this VCR to both the LINE IN and LINE OUT jacks of the other VCR, select the input correctly to prevent a humming noise.
- Make sure you set the CONNECT LINE-1 switch to OTHERS.

## Operation (when recording on this VCR)

You can make a copy of a tape using this VCR for recording or playback. The VCR cannot record TV programmes directly since it does not have a TV tuner.

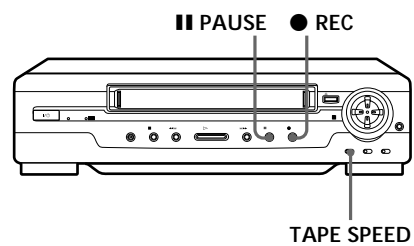

### Before you start editing

- Turn on your TV and set it to the video channel.

- Set TAPE SPEED to select the tape speed (SP or LP for the PAL colour system and SP or EP for the NTSC colour system).  
LP provides a recording time twice as long as SP. EP provides a recording time three times as SP. However, SP produces better picture quality.

- Insert a source tape with its safety tab removed into the other (playback) VCR. Search for the point to start playback and set it to playback pause.

- Insert a tape with its safety tab in place into this (recording) VCR. Search for the point to start recording and press PAUSE.

- Press REC on this VCR to set it to recording pause.

- To start editing, press the PAUSE buttons on both VCRs at the same time.

### To stop editing

Press the STOP buttons on both VCRs.

### To check the remaining tape length

Press DISPLAY.

The white bar indicates the approximate length of the tape recording.

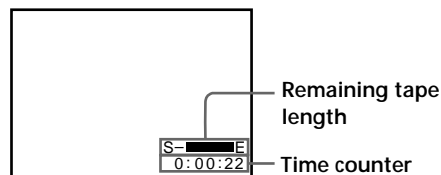

To turn the display off, press DISPLAY again.

### To save a recording

To prevent accidental erasure, break off the safety tab as illustrated. To record on a tape again, cover the tab hole with adhesive tape.



#### Tips

- To edit more precisely, press the PAUSE buttons on the VCRs to release pause.
- To cut out unwanted scenes while editing, press PAUSE on this VCR when an unwanted scene begins. When that scene ends, press PAUSE again to resume recording.

## Synchronised recording

The Synchronised Recording feature enables you to record from the connected equipment such as a satellite tuner, a cable TV decoder or a TV that has a timer function. Once you set the timer on the other equipment, the VCR will start recording the programme synchronised with the timer.

### How to connect to use this function

Connect the other equipment to the LINE IN jacks of this VCR.

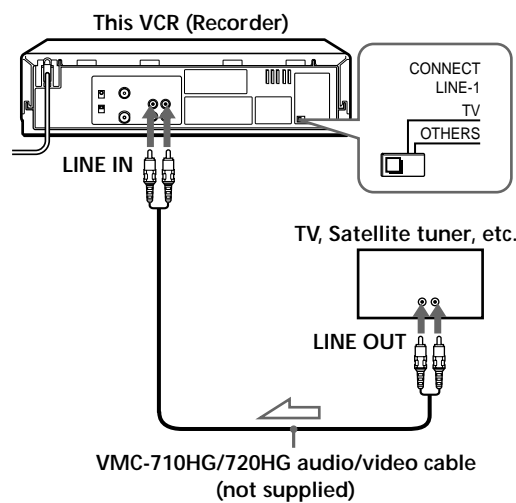

Signal flow

### Setting the CONNECT LINE-1 switch

When you connect the other equipment to the LINE IN jacks, set the CONNECT LINE-1 switch on the rear of the VCR following the table below to allow better signal transmission to your TV.

If the VCR is connected to	Set the CONNECT LINE-1 switch to
TV	TV
Satellite, cable TV decoder, etc.	OTHERS

## To prepare the Synchronised recording

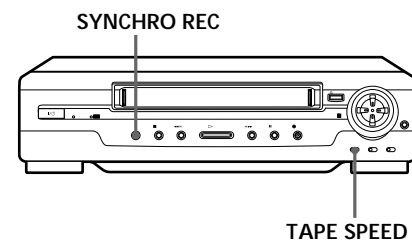

- Set the timer on the equipment to the time of the programme you want to record, then turn the equipment off.
- Insert a tape with its safety tab in place. Make sure the tape is longer than the total recording time.
- Set TAPE SPEED to select the tape speed (SP or LP for the PAL colour system and SP or EP for the NTSC colour system).
- Hold SYNCHRO REC down for more than two seconds. The SYNCHRO REC button lights up and the VCR stands by for recording.

The VCR automatically turns on and starts recording when it receives audio/video signals from the connected equipment.

### To cancel the Synchronised recording

Press SYNCHRO REC so that the button's light turns off.

### To stop recording

Press STOP while recording.

The VCR automatically stops recording when the tape reaches the end or when the other equipment stops transmitting the audio/video signals.

#### Notes

- Some TVs or other equipment automatically turn off in a certain time if you do not operate it after it turns on with the timer. In this case the Synchronised Recording also stops automatically.
- The Synchronised Recording starts and stops according to the signals from the connected equipment. Refer also to the instruction manual of the connected equipment for its timer function.
- Some equipment keeps transmitting signals even though the power is off. In this case, the Synchronised Recording feature does not work because the VCR will not be able to know when to start recording.

## Warning

To prevent fire or shock hazard, do not expose the VCR to rain or moisture. To avoid electrical shock, do not open the cabinet. Refer servicing to qualified personnel only.

The mains lead must only be changed at a qualified service shop.

### Precautions

#### Safety

- This VCR operates on 110 – 240 V AC, 50/60 Hz. Check that the VCR's operating voltage is identical with your local power supply.
- If anything falls into the cabinet, unplug the VCR and have it checked by qualified personnel before operating it any further.
- The VCR is not disconnected from the mains as long as it is connected to the mains, even if the VCR itself has been turned off.
- Unplug the VCR from the mains if you do not intend to use it for an extended period of time. To disconnect the cord, pull it out by the plug, never by the cord.

#### Installing

- Allow adequate air circulation to prevent internal heat buildup.
- Do not place the VCR on surfaces (rugs, blankets, etc.) or near materials (curtains, draperies) that may block the ventilation slots.
- Do not install the VCR near heat sources such as radiators or air ducts, or in a place subject to direct sunlight, excessive dust, mechanical vibration or shock.

- Do not install the VCR in an inclined position. It is designed to be operated in a horizontal position only.
- Keep the VCR and cassettes away from equipment with strong magnets, such as microwave ovens or large loudspeakers.
- Do not place heavy objects on the VCR.
- If the VCR is brought directly from a cold to a warm location, moisture may condense inside the VCR and cause damage to the video head and tape. When you first install the VCR, or when you move it from a cold to a warm location, wait for about one hour before operating the VCR.

#### Caution

Television programmes, films, video tapes, and other materials may be copyrighted. Unauthorized recording of such material may be contrary to the provisions of the copyright laws. Also, use of this recorder with cable television transmission may require authorization from the cable television transmitter and/or programme owner.

#### Compatible colour systems

- This VCR is designed to record and play back using the PAL, MESECAM, NTSC 3.58 and NTSC 4.43 colour systems. Recording of video sources based on other colour systems cannot be guaranteed.
- Tapes recorded with the NTSC colour system can be played back on this VCR using a TV or a colour monitor for the PAL colour system.
- To play back tapes recorded with the PAL and MESECAM colour systems, you need a TV or colour monitor compatible with these systems.

## Specifications

### System

Colour system  
PAL, MESECAM, NTSC 3.58, NTSC 4.43

RF output signal  
UHF channels 30 to 39  
(B/G, D/K)

Aerial out  
75-ohm asymmetrical aerial socket

### Inputs and outputs

LINE IN  
VIDEO IN, phono jack (1)  
Input signal: 1 V<sub>p-p</sub>, 75 ohms, unbalanced, sync negative

AUDIO IN, phono jack (1)  
Input level: 327 mV<sub>rms</sub>  
Input impedance: more than 47 kilohms

LINE OUT  
VIDEO OUT, phono jack (1)  
Output signal: 1 V<sub>p-p</sub>, 75 ohms, unbalanced, sync negative

AUDIO OUT, phono jack (1)  
Standard output: 327 mV<sub>rms</sub>  
Load impedance: 47 kilohms  
Output impedance: less than 10 kilohms

### General

Power requirements  
110 – 240 V AC, 50/60 Hz

Power consumption  
12 W

Operating temperature  
5°C to 40°C

Storage temperature  
–20°C to 60°C

Dimensions  
Approx. 355 × 96 × 293 mm (w/h/d) including projecting parts and controls

Mass  
Approx. 3.8 kg

### Supplied accessories

Remote commander (1)  
R6 (Size AA) batteries (2)  
Aerial cable (1)

Design and specifications are subject to change without notice.

## Troubleshooting

If you have any questions or problems not covered below, please consult your nearest Sony service facility.

	Symptom	Remedy
Power	The I/⏻ ON/STANDBY switch does not function.	• Connect the mains lead securely.
	The power is turned on but the VCR does not operate.	• Moisture condensation has occurred. Turn the power off, unplug the mains lead and leave the VCR to dry for over an hour.
	The VCR enters standby mode or turns off automatically.	• The auto safety system is triggered to protect your tape and the VCR's mechanism when there is something wrong with the tape or when the mechanism is overloaded. Press I/⏻ ON/STANDBY to restart the VCR. If the VCR does not work after pressing I/⏻ ON/STANDBY again, disconnect the mains lead from the mains. Wait for at least 15 seconds. Then reconnect the mains, and press I/⏻ ON/STANDBY again. If the VCR still does not work, please consult your nearest Sony service facility.
Playback	The playback picture does not appear on the TV screen.	• Make sure the TV is set to the video channel. If you are using a monitor, set it to video input.
	The picture is not clear.	• Adjust the tracking with the ▲/▼ NORMAL/SLOW/STILL ADJUST buttons. • Make sure the COLOR SYSTEM switch is set to the position corresponding to the colour system which the tape was recorded with. • The video heads are dirty (see below). Clean the video heads using the Sony T-25CLD, T-25CLW or E-25CLDR video head cleaning cassette. If these cleaning cassettes are not available in your area, have the heads cleaned at your nearest Sony service facility (a standard service charge will be required). Do not use a commercially available liquid type cleaning cassette, as it may damage the video heads. • The video heads may have to be replaced. Consult your local Sony service facility for more information.
	The picture rolls vertically during picture search.	• Adjust the vertical hold control on the TV or monitor.
Recording	The picture has no sound.	• The tape is defective. • If you made A/V connections, check the audio cable connection.
	The tape starts playing as soon as it is inserted.	• The safety tab has been removed. To record on this tape, cover the tab hole.
	The tape is ejected when you press ● REC.	• Check that the safety tab has not been removed
Others	Nothing happens when you press ● REC.	• Make sure the tape is not at its end.
	A tape cannot be inserted.	• Check that a tape is not already in the tape compartment.
	The remote commander does not function.	• Make sure you are pointing the remote commander at the remote sensor on the VCR. • Replace all the batteries in the remote commander with new ones if they are weak.
	The VCR needs to be cleaned.	• Clean the cabinet, panel, and controls with a dry soft cloth, or a soft cloth slightly moistened with a mild detergent solution. Do not use any type of solvent, such as alcohol or benzine.
	The indicator lights on the unit are flashing. The RESOLUTION CONTROL II menu appears automatically.	• The demonstration mode has been turned on. Cancel the demonstration mode by pressing STD PICT.

### Auto head cleaner

The VCR incorporates an auto head cleaner which cleans the video heads when a tape is loaded or unloaded. When the heads are not sufficiently clean, even after a tape has been loaded/unloaded several times, use a video head cleaning cassette.

### Symptoms caused by contaminated video heads

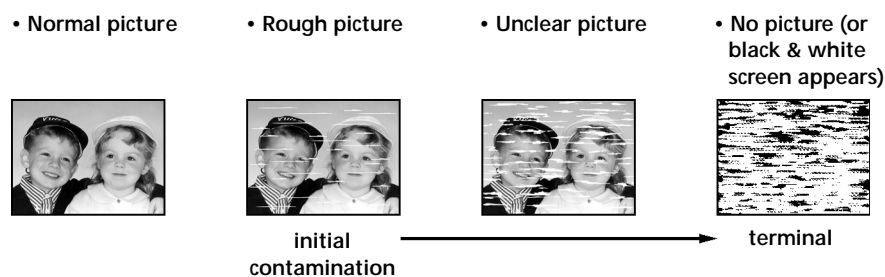

## Demonstration mode

The demonstration mode will activate when you press STD PICT and the RESOLUTION CONTROL II down button on the unit at the same time.

When demonstration mode starts during playback, RESOLUTION CONTROL II menu appears and the level of picture adjustment changes automatically.

When demonstration mode starts during power off and Synchronised Recording off, the indicator lights on the unit flash.

**To cancel the demonstration mode**  
Press STD PICT.