

CD/DVD Player

Operating Instructions

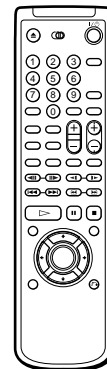
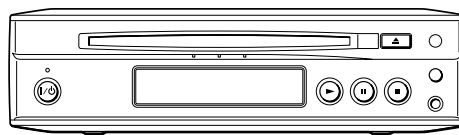

DVP-F11

WARNING

To prevent fire or shock hazard, do not expose the unit to rain or moisture. To avoid electrical shock, do not open the cabinet. Refer servicing to qualified personnel only.

Mains cord must only be changed at qualified service shop.

CAUTION

The use of optical instruments with this product will increase eye hazard. As the laser beam used in this CD/DVD player is harmful to eyes, do not attempt to disassemble the cabinet. Refer servicing to qualified personnel only.

Precautions

Safety

- The power requirements of this unit is indicated on the back of the unit. Check that the unit's operating voltage is identical with your local power supply.

Power requirements →



- If anything falls into the cabinet, unplug the unit and have it checked by qualified personnel before operating it any further.
- The unit is not disconnected from the mains as long as it is connected to the mains outlet, even if the unit itself has been turned off.
- Unplug the unit from the wall outlet if you do not intend to use it for an extended period of time. To disconnect the cord, pull it out by the plug, never by the cord.
- Do not use the unit in a car. The operation cannot be guaranteed.

Installing

- Allow adequate air circulation to prevent internal heat buildup.
- Do not place the unit on surfaces (rugs, blankets, etc.) or near materials (curtains, draperies) that may block the ventilation slots.
- Do not install the unit near heat sources such as radiators or air ducts, or in a place subject to direct sunlight, excessive dust, mechanical vibration or shock.
- Do not install the unit in an inclined position. It is designed to be operated in a horizontal or vertical position only.
- Keep the unit and discs away from equipment with strong magnets, such as microwave ovens or large loudspeakers.
- Do not place heavy objects on the unit.
- If the unit is brought directly from a cold to a warm location, moisture may condense inside the CD/DVD player and cause damage to the lenses. When you first install the unit, or when you move it from a cold to a warm location, wait for about one hour before operating the unit.

Welcome!

Thank you for purchasing the Sony CD/DVD Player. Before operating the unit, please read this manual thoroughly and retain it for future reference.

TABLE OF CONTENTS

About This Manual	4
This Player Can Play the Following Discs	4
Precautions	6
Notes on Discs	7

Getting Started 8

Unpacking	8
TV Hookups	10
Receiver (Amplifier) Hookups	12
2.1 Channel Surround Hookups	14
5.1 Channel Surround Hookups	15
Selecting the Language for On-Screen Display	17

Playing Discs 18

Playing Discs	18
Searching for a Particular Point on a Disc	20
Resuming Playback from the Point Where You Stopped the Disc (Resume Play)	21
Using the Menu for Each DVD	22
Playing VIDEO CDs with PBC Functions (PBC Playback)	23
Using the Front Panel Display	24

Using Various Functions with the Control Menu 26

Using the Control Menu Display	26
Control Menu Item List	28
Searching for the Title/Chapter/Track/Index/Scene	29
Checking the Playing Time and Remaining Time	30
Selecting a Start Point Using the Time Code	30
Checking the Information of the Disc	31
Changing the Sounds	32
Displaying the Subtitles	33
Changing the Angles	34
Setting for Digital Cinema Sound	35
Creating Your Own Program (Program Play)	36
Playing in Random Order (Shuffle Play)	38
Playing Repeatedly (Repeat Play)	39
Repeating a Specific Portion (A↔B Repeat)	39
Checking the Play Information	41

Settings and Adjustments 42

Using the Setup Display	42
Setup Display Item List	44
Setting the Language for Display and Sound (LANGUAGE SETUP)	45
Settings for Display (SCREEN SETUP)	46
Custom Settings (CUSTOM SETUP)	47
Settings for Sound (AUDIO SETUP)	50
Speaker Set Up	53
Controlling the TV or the AV Receiver (Amplifier) with the Supplied Remote	54





Additional Information 56

Troubleshooting	56
Self-diagnosis Function	59
Specifications	60
Glossary	61
Language Code List	63
Index to Parts and Controls	64
Index	67



About This Manual

Conventions

- Instructions in this manual describe the controls on the player. You can also use the controls on the remote if they have the same or similar names as those on the player.
- The icons on the right are used in this manual:

Icon	Meaning
	Indicates that you can use only the remote to do the task.
	Indicates tips and hints for making the task easier.
	Indicates the functions for DVD VIDEOS.
	Indicates the functions for VIDEO CDs.
	Indicates the functions for Audio CDs.

This Player Can Play the Following Discs

	DVD VIDEOS		VIDEO CDs		Audio CDs	
Disc logo						
Contents	Audio + Video		Audio + Video		Audio	
Disc size	12 cm	8 cm	12 cm	8 cm	12 cm	8 cm (CD single)
Play time	About 4 h (for single-sided DVD)/ about 8 h (for double-sided DVD)	About 80 min. (for single-sided DVD)/ about 160 min. (for double-sided DVD)	74 min.	20 min.	74 min.	20 min.

“DVD VIDEO” logo is a trademark.

This player switches the color system, PAL or NTSC, according to the connected TV. (For details, see page 11.)

Region code of DVDs you can play on this unit

Your DVD player has a region code printed on the back of the unit and will only play DVDs that are labeled with identical region codes.

DVDs labeled  will be also played on this unit.

If you try to play any other DVD, the message “Playing this disc prohibited by area limits.” will appear on the TV screen.

Depending on the DVD, no region code indication may be labeled even though playing the DVD is prohibited by the area limits.



Note on playback operations of DVDs and VIDEO CDs

Some playback operations of DVDs and VIDEO CDs may be intentionally fixed by software producers. Since this player plays DVDs and VIDEO CDs according to the disc contents the software producers designed, some playback features may not be available. Also refer to the instructions supplied with the DVDs or VIDEO CDs.

Terms for discs

- **Title**
The longest sections of a picture or a music piece on a DVD; a movie, etc., for a picture piece on a video software; or an album, etc., for a music piece on an audio software. Each title is assigned a title number enabling you to locate the title you want.
- **Chapter**
Sections of a picture or a music piece that are smaller than titles. A title is composed of several chapters. Each chapter is assigned a chapter number enabling you to locate the chapter you want. Depending on the disc, no chapters may be recorded.
- **Track**
Sections of a picture or a music piece on a VIDEO CD or a CD. Each track is assigned a track number enabling you to locate the track you want.

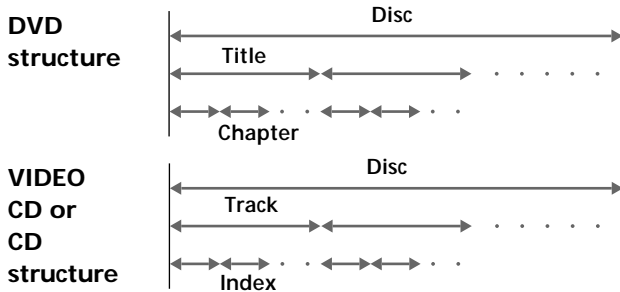

- **Index (CD) / Video Index (VIDEO CD)**
A number that divides a track into sections to easily locate the point you want on a VIDEO CD or a CD. Depending on the disc, no indexes may be recorded.
- **Scene**
On a VIDEO CD with PBC functions, the menu screens, moving pictures and still pictures are divided into sections called "scenes." Each scene is assigned a scene number enabling you to locate the scene you want.

Note on PBC (Playback Control) (VIDEO CDs)

This player conforms to Ver. 1.1 and Ver. 2.0 of VIDEO CD standards. You can enjoy two kinds of playback according to the disc type.

Disc type	You can
VIDEO CDs without PBC functions (Ver. 1.1 discs)	Enjoy video playback (moving pictures) as well as music.
VIDEO CDs with PBC functions (Ver. 2.0 discs)	Play interactive software using menu screens displayed on the TV screen (PBC Playback), in addition to the video playback functions of Ver 1.1 discs. Moreover, you can play high-resolution still pictures, if they are included on the disc.

Discs that the player cannot play

The player cannot play discs other than the ones listed in the table on page 4. CD-R, CD-ROMs including PHOTO CDs, data sections in CD-EXTRAS, DVD-ROMs, DVD-Audio, HD (high density) layer of "Super Audio CD," etc., cannot be played.

When playing DTS*-encoded CDs, excessive noise will be heard from the analog stereo outputs. To avoid possible damage to the audio system, the consumer should take proper precautions when the analog stereo outputs of the DVD player are connected to an amplification system. To enjoy DTS Digital Surround™ playback, an external 5.1-channel DTS Digital Surround™ decoder system must be connected to the digital output of the DVD player.

This product incorporates copyright protection technology that is protected by method claims of certain U.S. patents and other intellectual property rights owned by Macrovision Corporation and other rights owners. Use of this copyright protection technology must be authorized by Macrovision Corporation, and is intended for home and other limited viewing uses only unless otherwise authorized by Macrovision Corporation. Reverse engineering or disassembly is prohibited.

* "DTS" is a trademark of Digital Theater Systems, Inc.

Precautions

On safety

- Caution – The use of optical instruments with this product will increase eye hazard.
- Should any solid object or liquid fall into the cabinet, unplug the player and have it checked by qualified personnel before operating it any further.
- Do not put any foreign objects in the DC IN 10.5 V (external power input) jack.

On AC power adaptor and AC power cord

- Use only the supplied AC power adaptor. Do not use any other AC power adaptor. It may cause a malfunction.

Polarity of the plug



- If the AC power adaptor causes interference to the radio reception, move it away from the radio.
- Do not touch the AC power adaptor with wet hands.
- The player is not disconnected from the AC power source (mains) as long as it is connected to the wall outlet, even if the player itself has been turned off.
- If you are not going to use the player for a long time, be sure to disconnect the player from the wall outlet. To disconnect the AC power cord (mains lead), grasp the plug itself; never pull the cord.
- Should the AC power cord (mains lead) need to be changed, have it done at a qualified service shop only.

On placement

- Place the player in a location with adequate ventilation to prevent heat build-up in the player.
- Do not place the player and the AC power adaptor on a soft surface such as a rug that might block the ventilation holes on the bottom.
- Do not place the player in a location near heat sources, or in a place subject to direct sunlight, excessive dust or mechanical shock.
- Do not put any heavy object on top of the player. The player may be damaged.

On operation

- If the player is brought directly from a cold to a warm location, or is placed in a very damp room, moisture may condense on the lenses inside the player. Should this occur, the player may not operate properly. In this case, remove the disc and leave the player turned on for about half an hour until the moisture evaporates.

On adjusting volume

- Do not turn up the volume while listening to a portion with very low level inputs or no audio signals. If you do, the speakers may be damaged when a peak level portion is played.

On cleaning

- Clean the cabinet, panel and controls with a soft cloth slightly moistened with a mild detergent solution. Do not use any type of abrasive pad, scouring powder or solvent such as alcohol or benzine.

If you have any questions or problems concerning your player, please consult your nearest Sony dealer.

IMPORTANT NOTICE

Caution: The enclosed DVD player is capable of holding a still video image or On screen display image on your television screen indefinitely. If you leave the still video image or On screen display image displayed on your TV for an extended period of time you risk permanent damage to your television screen. Projection televisions are very susceptible.

Notes on Discs

On handling discs

- Do not use irregularly shaped CDs such as heart- or star-shaped CD as they may cause the player to malfunction.
- To keep the disc clean, handle the disc by its edge. Do not touch the surface.
- Do not stick paper or tape on the disc.
If there is glue (or a similar substance) on the disc, remove the glue completely before using the disc.

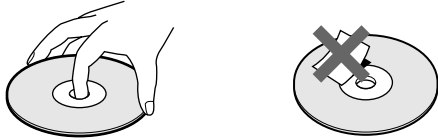

- Do not expose the disc to direct sunlight or heat sources such as hot air ducts, or leave it in a car parked in direct sunlight as there can be considerable rise in temperature inside the car.
- After playing, store the disc in its case.

On cleaning

- Before playing, clean the disc with a cleaning cloth.
Wipe the disc from the center out.

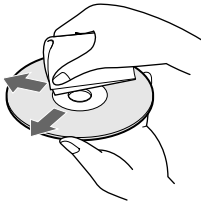

- Do not use solvents such as benzine, thinner, commercially available cleaners or anti-static spray intended for vinyl LPs.

Getting Started

This section describes how to hook up the CD/DVD player to a TV (with audio/video input jacks) and/or an AV receiver (amplifier). You cannot connect this player to a TV which does not have a video input connector. Be sure to turn off the power of each component before making the connections.

Unpacking

Check that you have the following items:

- Audio/video connecting cord (1)
- S video cord (1)
- AC power adaptor AC-F11 (1)
- AC power cord (1)
- Remote commander (remote) RMT-D109E (1)
- R6 (size AA) batteries (2)
- Stand (1)

Inserting batteries into the remote

You can control the player using the supplied remote. Insert two Size AA (R6) batteries by matching the + and - on the batteries. When using the remote, point it at the remote sensor  on the player.

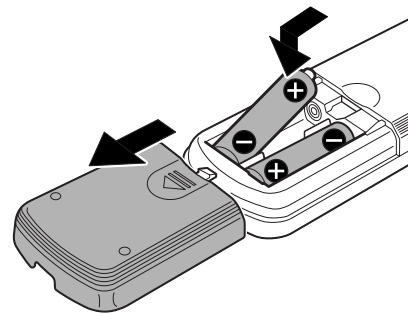

 You can control TVs and AV receivers using the supplied remote
See page 54.

Notes

- Do not leave the remote in an extremely hot or humid place.
- Do not drop any foreign object into the remote casing, particularly when replacing the batteries.
- Do not expose the remote sensor to direct sunlight or lighting apparatuses. Doing so may cause a malfunction.
- If you will not use the remote for an extended period of time, remove the batteries to avoid possible damage from battery leakage and corrosion.

Using the player in a vertical position

If you want to use the player in a vertical position, attach the supplied stand.

- 1 Align the groove of the player and the projection of the stand.

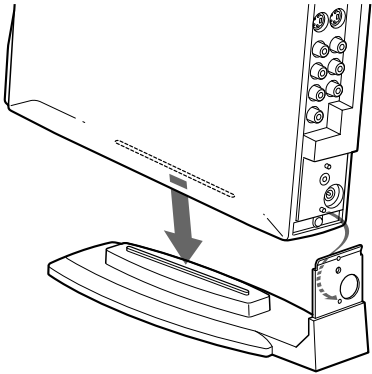

- 2 Fasten the stand with the supplied screw.

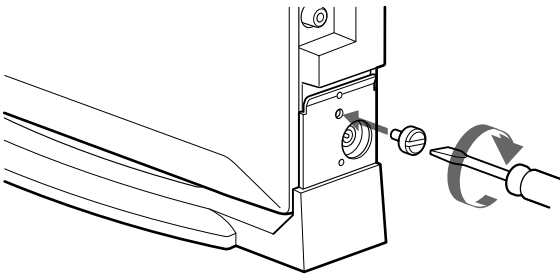

Notes

- When you place the player in a horizontal position, remove the stand.
- To move the player, hold the player itself. If you hold the stand, the stand may break.

TV Hookups

This connection is for listening to the sound through TV speakers (2ch - L, R). Refer to the instructions supplied with the component to be connected. Set "SUBWOOFER" in "SPEAKER SETUP" to "NONE" in the setup display (page 53).

Required cords

Audio/video connecting cord (supplied) (1)

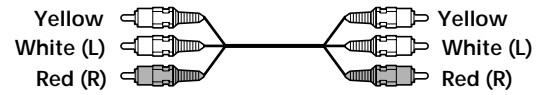

S video cord (supplied) (1)



When connecting the cords, be sure to match the color-coded cord to the appropriate jacks on the components: Yellow (video) to Yellow, Red (right) to Red and White (left) to White. Be sure to make connections firmly to avoid hum and noise.

If your TV has an S video input connector, connect the component via the S-VIDEO connector using the S video cord. You will get a better picture.

Refer to the instructions supplied with the TV to be connected.

CD/DVD player

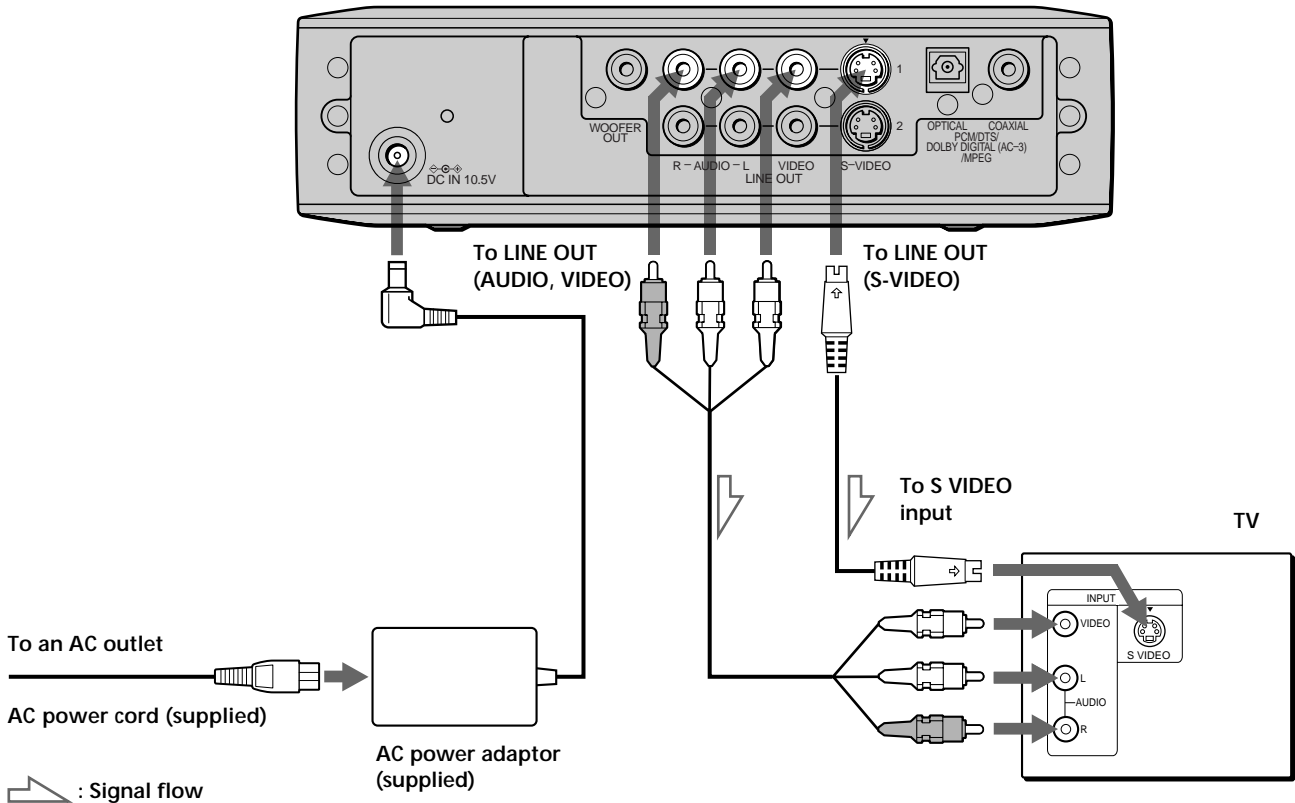

Notes

- Refer to the instructions supplied with the component to be connected.
- Do not connect this player to a video deck. If you view the pictures on your TV after making the connections shown below, a picture noise may appear.

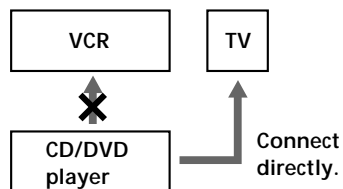

- Depending on the TV or receiver (amplifier), sound distortion may occur because the audio output level is high. In this case, set "AUDIO ATT" in "AUDIO SETUP" to "ON" in the setup display. For details, see page 50.

Setups for the player

Some setups are necessary for the player depending on the TV or other components to be connected.

Use the setup display to change the various settings.

For details on using the setup display, see page 42.

- **If the color system of the TV is NTSC or DUAL**
Since the color system of the unit is set to NTSC, you can use the unit as it is.
- **If the color system of the TV is PAL**
To set the unit to PAL, turn on the unit while pressing the **■** button of the unit. To reset to NTSC, turn off the unit and then turn on as described above.
- **To connect the player to a wide-screen TV**
In the setup display, set "TV TYPE" in "SCREEN SETUP" to "16:9" (default setting). For details, see page 46.
- **To connect the player to a normal TV**
In the setup display, set "TV TYPE" in "SCREEN SETUP" to "4:3 LETTER BOX" or "4:3 PAN SCAN."
For details, see page 46.

Receiver (Amplifier) Hookups

This connection is for listening to the sound through speakers connected to a receiver. Refer to the instructions supplied with the component to be connected. Set "SUBWOOFER" in "SPEAKER SETUP" to "NONE" in the setup display (page 53).

 You can enjoy surround when connecting front speakers only. You can use 3D sound imaging to create virtual rear speakers from the sound of the front speakers (L, R) without using actual rear speakers (Virtual Enhanced Surround). For details, see page 35.

Required cords

Audio connecting cord (not supplied) (1)

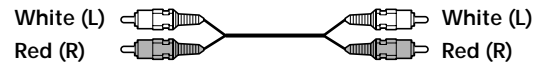

S video cord (supplied) (1)



When connecting the cords, be sure to match the color-coded cord to the appropriate jacks on the components: Red (right) to Red and White (left) to White. Be sure to make connections firmly to avoid hum and noise.

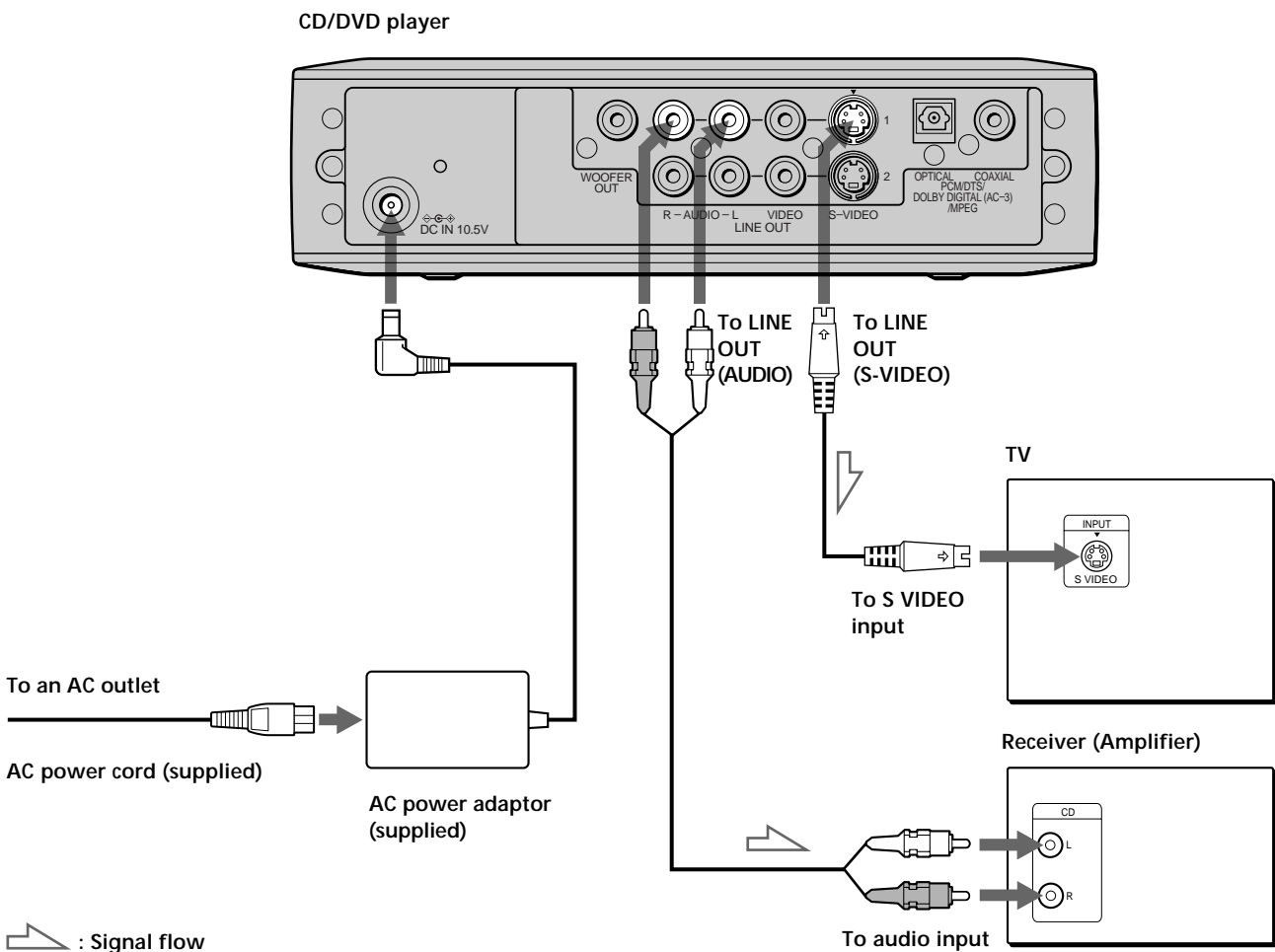

Note

You cannot enjoy the picture with S video signal if your TV is not conformed to the S video signal. When your TV does not have S VIDEO input, connect the component via the VIDEO INPUT connector using the video connecting cord (not supplied) instead of the S video cord. For details, see page 10. Refer to the instructions supplied with your TV.

If you have a digital component such as a receiver (amplifier) with a digital connector, DAT or MD

Connect the component via the OPTICAL or COAXIAL connector using an optical or coaxial digital connecting cord (not supplied).

■ When using an optical digital connecting cord

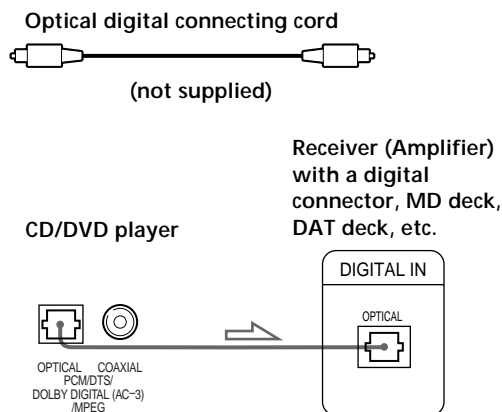

■ When using a coaxial digital connecting cord

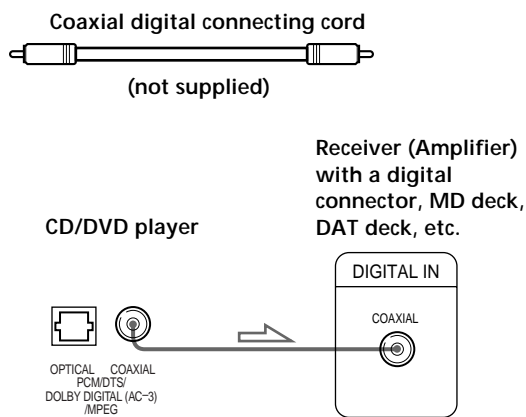

Notes

- Refer to the instructions supplied with the component to be connected.
- You cannot make digital audio recordings of discs recorded in multi-channel surround format directly using an MD deck or DAT deck.

When you make the connections above, do not set "DOLBY DIGITAL" to "DOLBY DIGITAL," "MPEG" to "MPEG" and "DTS" to "ON." If you do, a loud noise will suddenly come out from the speakers, affecting your ears or causing the speakers to be damaged.

💡 If you have a digital component with a built-in DTS, Dolby Digital or MPEG decoder

You can enjoy multichannel surround sound by connecting the component via the OPTICAL or COAXIAL connector using an optical or coaxial digital connecting cord (not supplied). For details on hookups and settings, see page 15.

Setups for the player

Some setups are necessary for the player depending on the components to be connected.

Use the setup display to change the various settings.

For details on using the setup display, see page 42.

- To listen to the sound through speakers connected to a receiver (amplifier) having a digital connector or to output the sound to a digital component such as a DAT or MD deck

When you play a DVD, set "DIGITAL OUT" in "AUDIO SETUP" to "ON" and then set "DOLBY DIGITAL" to "D-PCM," "MPEG" to "PCM" and "DTS" to "OFF" in the setup display (page 51). These are the default settings.

2.1 Channel Surround Hookups

This connection is for listening to the sound through the left and right speakers of the TV, or those connected to a receiver and the subwoofer. You can enjoy rich bass frequencies by connecting a subwoofer. Refer to the instructions supplied with the component to be connected.

Set "SUBWOOFER" in "SPEAKER SETUP" to "YES" in the setup display (page 53). Then set "FRONT SPEAKER SIZE" to "TV" when you use the TV's speakers, or to "LARGE," "MIDDLE" or "SMALL" when you use the speakers connected to the receiver.

 You can enjoy surround when connecting front speakers only. You can use 3D sound imaging to create virtual rear speakers from the sound of the front speakers (L, R) without using actual rear speakers (Virtual Enhanced Surround). For details, see page 35.

Required cords

Audio connecting cord (not supplied) (1)

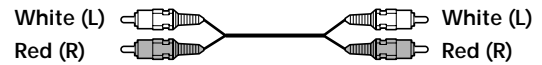

S video cord (supplied) (1)



When connecting the cords, be sure to match the color-coded cord to the appropriate jacks on the components: Red (right) to Red and White (left) to White. Be sure to make connections firmly to avoid hum and noise.

Monaural audio cord (not supplied) (1)

One for a subwoofer

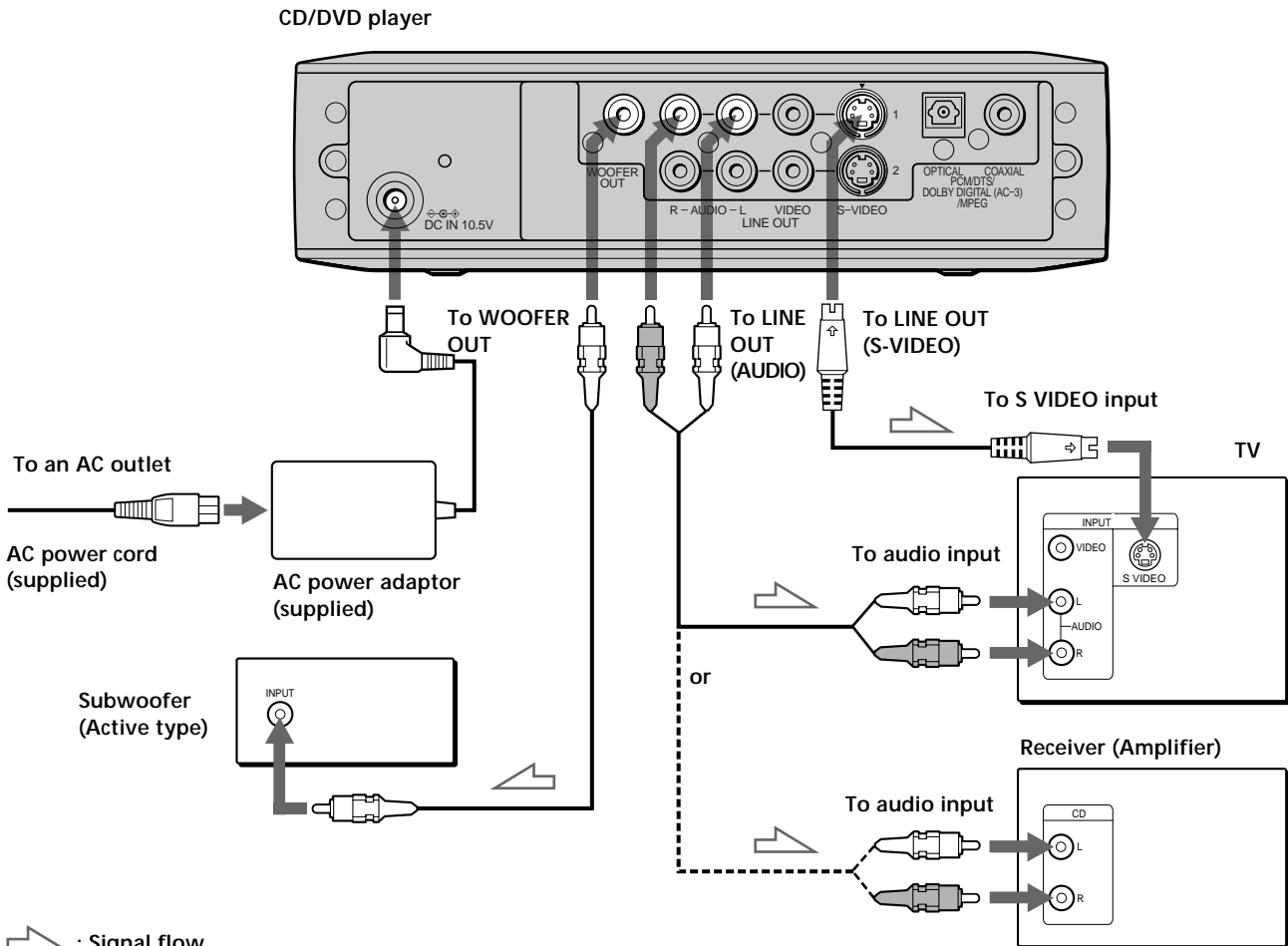

Note

You cannot enjoy the picture with S video signal if your TV is not conformed to the S video signal. When your TV does not have S VIDEO input, connect the component via the VIDEO INPUT connector using the video connecting cord (not supplied) instead of the S video cord. For details, see page 10. Refer to the instructions supplied with your TV.

5.1 Channel Surround Hookups

With DVDs which contain DTS, Dolby* Digital or MPEG AUDIO sound, you can enjoy the surround sound while producing the effect of being in a movie theater or a concert hall, using a digital component with a built-in DTS, Dolby Digital or MPEG decoder (not supplied). The player outputs the surround sound signals from the OPTICAL and COAXIAL connectors.

Using a receiver (amplifier) having the OPTICAL or COAXIAL connector and the 5 (+1) speakers, you can enjoy more real audio presence in the comfort of your own home.

Required cords

Audio cords (not supplied)

One for the LINE OUT (AUDIO 1, 2) jacks

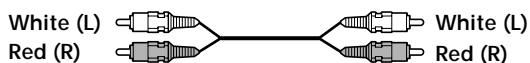

Optical or coaxial digital cord (not supplied)

One for the OPTICAL or COAXIAL jack

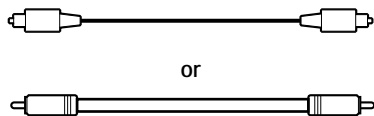

S video cord (supplied)

One for the S-VIDEO jack



Connect the component via the OPTICAL or COAXIAL connector using an optical or coaxial digital connecting cord (not supplied). You do not need to connect both of these cords. See the figure on the next page.

Notes

- Do not connect the power cord to an AC outlet or press the POWER switch before completing all connections.
- Refer to the instructions supplied with the component to be connected.
- The cord connectors should be fully inserted into the jacks. Loose connection may cause hum and noise.
- Jacks and plugs of the connecting cords are color-coded as follows:
Red jacks and plugs: Right audio channel
White jacks and plugs: Left audio channel

Setups for the player

Some setups are necessary for the player depending on the components to be connected.

Use the setup display to change the various settings. For details on using the setup display, see page 42.

- When you play a DVD that is recorded in DTS format
Set "DIGITAL OUT" in "AUDIO SETUP" to "ON" and then set "DTS" to "ON" in the setup display (page 51).
- When you play a DVD that is recorded in Dolby Digital format
Set "DIGITAL OUT" in "AUDIO SETUP" to "ON" and then set "DOLBY DIGITAL" to "DOLBY DIGITAL" in the setup display (page 51).
- When you play a DVD that is recorded in MPEG format
Set "DIGITAL OUT" in "AUDIO SETUP" to "ON" and then set "MPEG" to "MPEG" in the setup display (page 51).

Notes

- Refer to the instructions supplied with the component to be connected.
- When you do not connect an audio component with a built-in DTS decoder, do not set "DTS" to "ON."
- When you do not connect an audio component with a built-in DOLBY DIGITAL decoder, do not set "DOLBY DIGITAL" to "DOLBY DIGITAL."
- When you do not connect an audio component with a built-in MPEG decoder, do not set "MPEG" to "MPEG."

* Manufactured under license from Dolby Laboratories. "Dolby," "AC-3," "Pro Logic" and the double-D symbol  are trademarks of Dolby Laboratories. Confidential Unpublished Works. ©1992-1997 Dolby Laboratories, Inc. All rights reserved.

5.1 Channel Surround Hookups

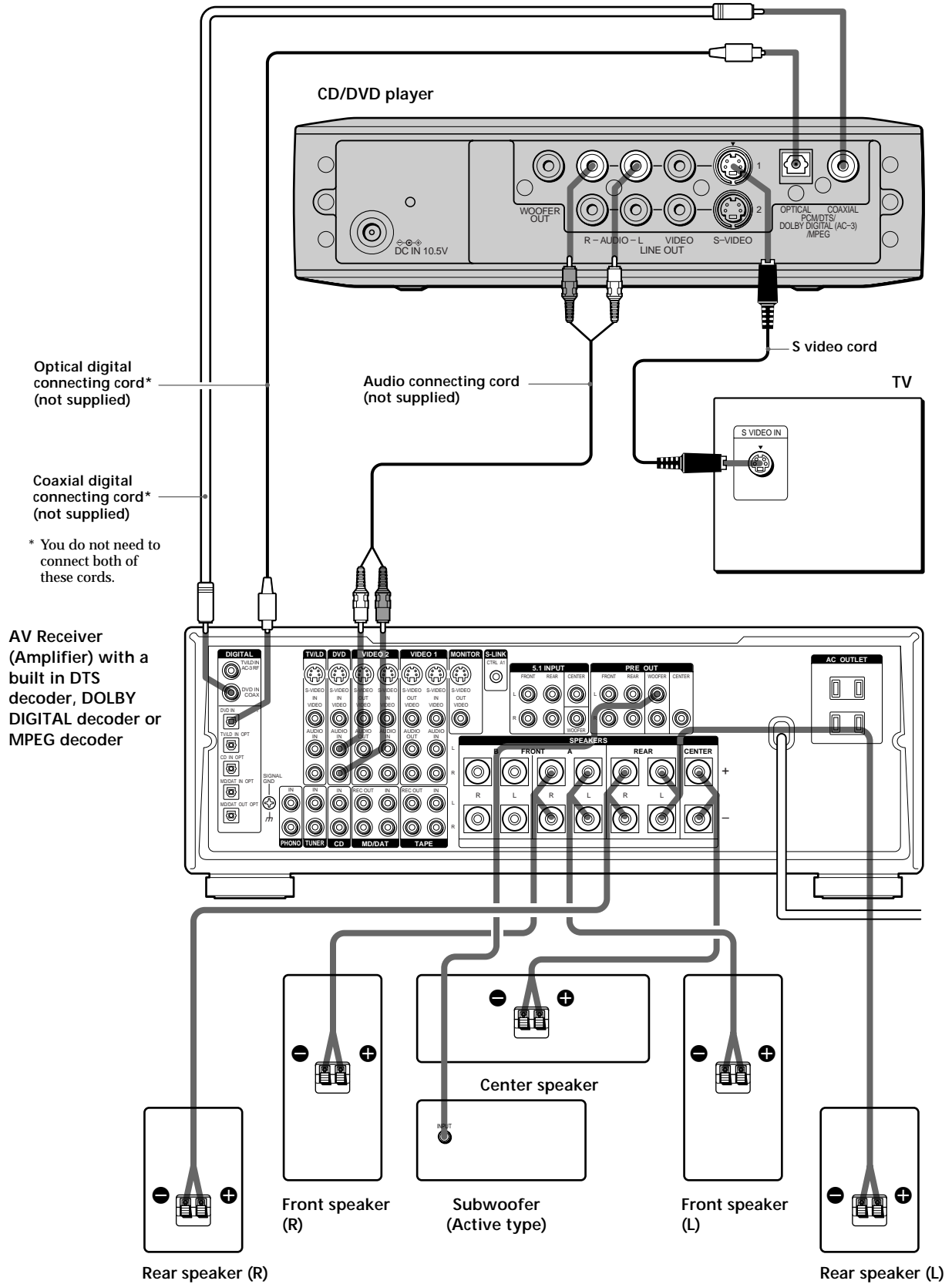

Selecting the Language for On-Screen Display

You can select the language for the setup display, the Control Menu display or the messages displayed on the screen. Default setting is "ENGLISH."

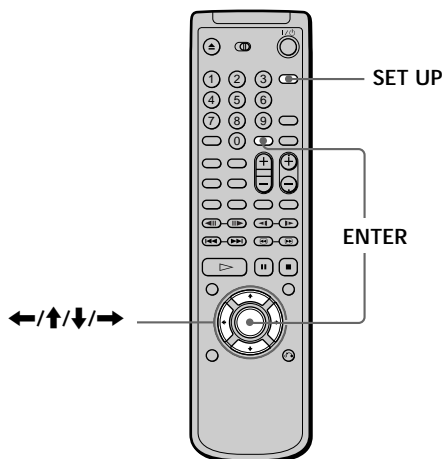

- 1 Press SET UP and select "LANGUAGE SETUP" using ↑/↓, and then press ENTER.

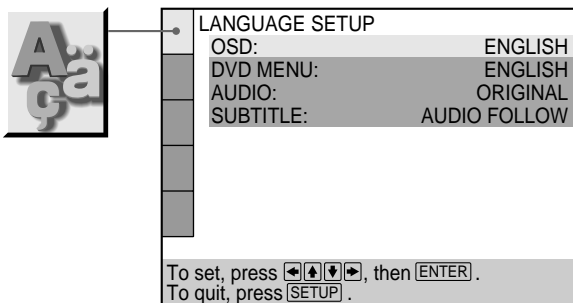

- 2 Select "OSD" using ↑/↓, then press → or ENTER.

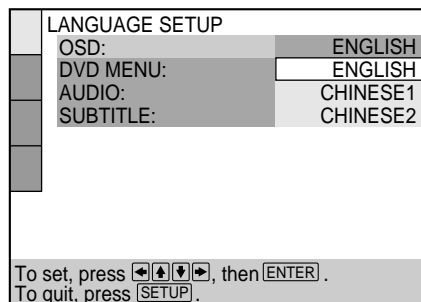

- 3 Select "CHINESE1" or "CHINESE2" using ↑/↓, then press ENTER.

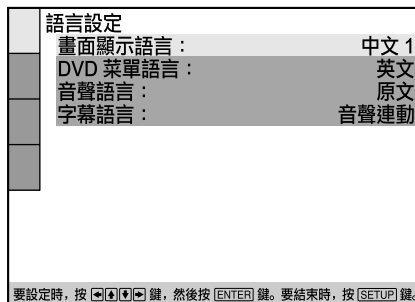

To cancel using the setup display on the way
Press SET UP.

Note

The languages you can select are the ones displayed in Step 2.
For details, see page 45.

Playing Discs

This chapter describes how to play a DVD/CD/VIDEO CD.

Playing Discs

Depending on the DVD or VIDEO CD, some operations may be different or restricted. Refer to the instructions supplied with your disc.

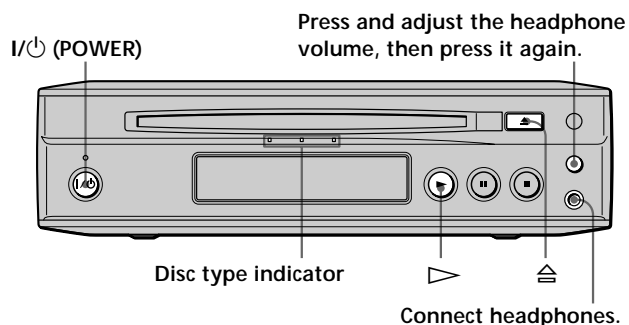

1 Make settings on your TV.

Turn on the TV and select the video input so that you can view the pictures from this player.

When using a receiver (amplifier)

Turn on the receiver (amplifier) and select the appropriate position so that you can listen to the sound from this player.

2 Press I/⏻ (POWER) to turn on the player.

The indicator (red) above the I/⏻ (POWER) button changes to green and the front panel display lights up.

3 Insert the disc.

The corresponding disc type indicator lights up.

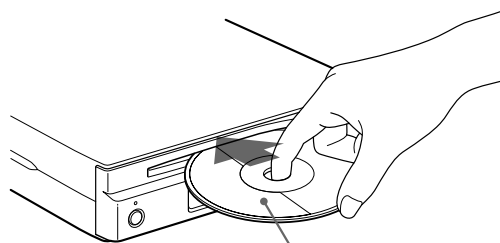

With the playback side facing down

4 Press ▶.

The player starts playback (Continuous Play). Adjust the volume on the TV or the receiver (amplifier).

After following Step 4

■ When playing a DVD

A DVD menu or title menu may appear on the TV screen (see page 22).

■ When playing a VIDEO CD

The menu screen may appear on the TV screen depending on the VIDEO CD. You can play the disc interactively, following the instructions on the menu screen. (PBC Playback, see page 23.)

 You can turn on the player using the remote
 Press I/⏻ (POWER) when the indicator above the I/⏻ (POWER) button on the front panel is lit in red.

Notes

- If you leave the player or the remote in pause or stop mode for 15 minutes, the screen saver image appears automatically. To make the screen saver image go away, press ▷. (If you want to set the screen saver function to off, see page 46.)
- The indicator above the I/⏻ (POWER) button lights up in red when the power is turned off.
- If you don't operate the player or the remote for more than 30 minutes when a disc is not being played, the power is automatically turned off. (Auto Power Off function)
- When you insert an 8-cm disc, insert the disc slowly at the center of the disc slot. If you cannot eject the disc, consult your nearest Sony dealer.
- With some new discs, glue from the manufacturing process may be present on the outer edge. Forcing such discs into the player may cause the disc to get stuck. Wipe the edge of the disc with the side of a pen or pencil so that the glue is spread evenly along the edge and does not ball up. Be sure not to touch the playback side of the disc when wiping the edge. Then insert the disc into the player.
- With some new discs, burrs from manufacturing may remain on the outer edge or inside the center hole. If such burrs are present, be sure to remove them by rubbing with the side of a pen or pencil. If burrs are not removed, discs may not load properly into the player, or fragments of plastic adhering to the playback side of the disc may cause skipping in the sound.
- No adapter is required in order to play 8-cm CDs on this player. If a single adapter is used, damage to the unit may result; therefore, never use an adapter when playing 8-cm CDs.

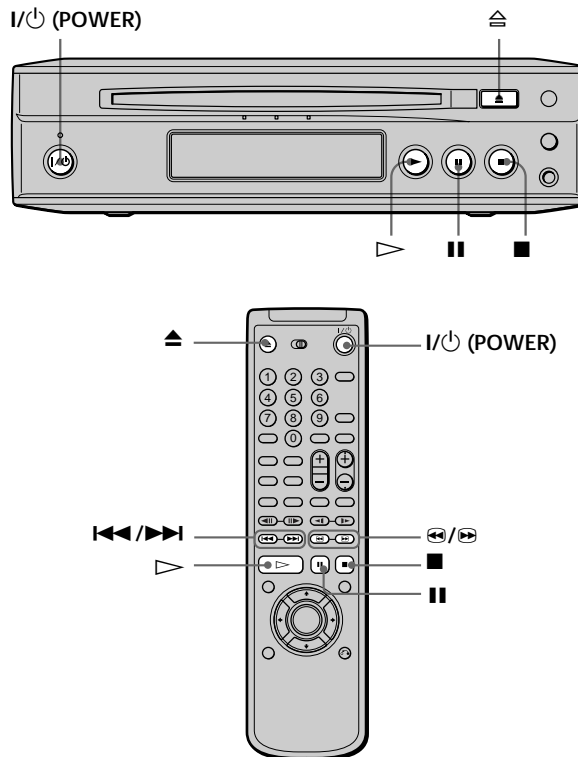

To	Operation
Stop	Press ■.
Pause	Press .
Resume play after pause	Press or ▷.
Go to the next chapter, track or scene in continuous play mode	Press ►► on the remote.
Go back to the preceding chapter, track or scene in continuous play mode	Press ◄◄ on the remote
Locate a point while monitoring the picture (Scan)	Press ◀ or ▶ on the remote. When you find the point you want, press ▷ to return to the normal speed.
Stop play and remove the disc	Press ▲.

You can play discs in various modes such as Program Play using the on-screen menu (Control Menu). For operations of Control Menu, see page 26.

Searching for a Particular Point on a Disc



You can locate a particular point on a disc by monitoring the picture, playing back slowly or playing frame by frame.

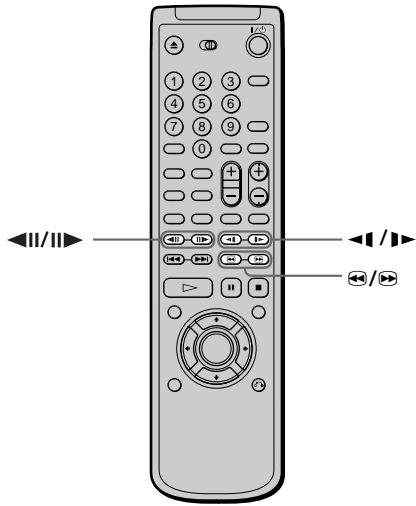

Locating a point slowly by observing the screen (Slow-motion play)



You can use this function only for DVDs or VIDEO CDs. Press ◀ or ▶ while playing a disc. When you find the point, press ▷ to return to the normal speed. Each time you press the ◀ or ▶ button during Slow-motion play, the playback speed changes. Two speeds are available. With each press, the indication changes as follows:

SLOW1▶ ↔ SLOW2▶ (playback direction)
SLOW1◀ ↔ SLOW2◀ (opposite direction - DVD only)

The playback speed of SLOW2▶ /SLOW2◀ is slower than SLOW1▶ /SLOW1◀.

Note

Depending on the DVD/VIDEO CD, you may not be able to do some of the operations described.

Locating a point quickly by playing a disc fast forward or fast reverse (Speed scan)

Press ◀◀ or ▶▶ while playing a disc. When you find the point, press ▷ to return to the normal speed. Each time you press the ◀◀ or ▶▶ button during Speed scan, the playback speed changes. Two speeds are available. With each press, the indication changes as follows:

FF1▶▶ ↔ FF2▶▶ (playback direction)
FR1◀◀ ↔ FR2◀◀ (opposite direction)

The playback speed of FF2▶▶ /FR2◀◀ is faster than FF1▶▶ /FR1◀◀.

Playing a disc frame by frame



You can use this function only for DVDs or VIDEO CDs. Press ◀◀ or ▶▶ while playing a disc. To return to normal playback, press ▷.

Resuming Playback from the Point Where You Stopped the Disc (Resume Play) **DVD** **VIDEO CD** **CD**

The player stores the point where you stopped the disc and if "RESUME" appears on the front panel display. You can resume playback from that point.

As long as you do not eject the disc, Resume Play is available even if you turn the power off.

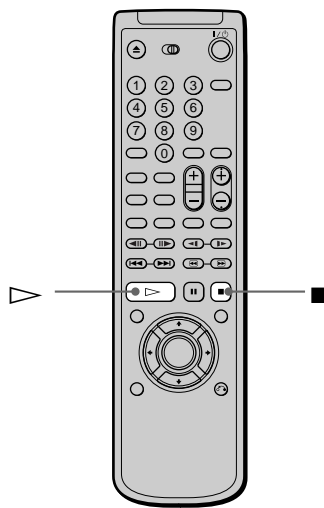
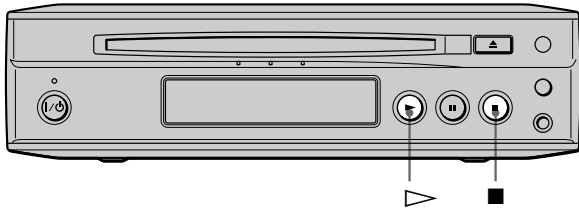

Notes

- Resume Play may not be available depending on the DVD.
- Resume Play is not available in Shuffle or Program Play mode.
- Depending on where you stopped the disc, the player may resume playback from a different point.
- The point where you stopped playing is cleared when:
 - you eject the disc
 - you disconnect the AC power cord
 - you change the play mode
 - you start playback after selecting a title, chapter or track
 - you change the settings of "PARENTAL CONTROL" in "CUSTOM SETUP" in the setup display
 - you change the settings of "AUDIO," "DVD MENU" and "SUBTITLE" in "LANGUAGE SETUP" in the setup display while playing a DVD

1 While playing a disc, press ■ to stop playback. "RESUME" appears in the front panel display and "When playing next time, disc restarts from point you stopped." appears on the TV screen. If "RESUME" does not appear, Resume Play is not available.

2 Press ▷.
The player starts playback from the point where you stopped the disc in Step 1.

 **To play from the beginning of the disc**
When the playing time appears on the front panel display before you start playing, press ■ to reset the playing time, then press ▷.

Using the Menu for Each DVD

Using the title menu

A DVD is divided into long sections of a picture or a music piece called “titles.” When you play a DVD which contains several titles, you can select the title you want using the title menu.

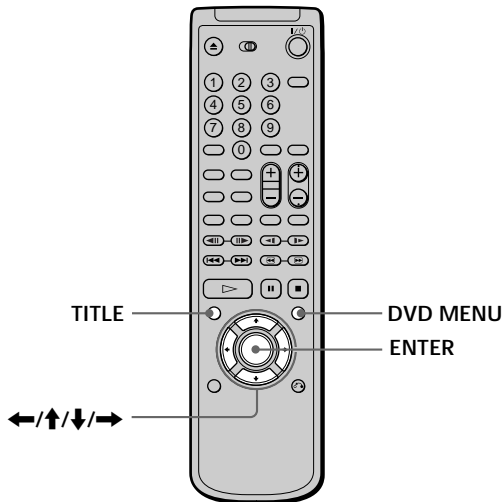

- 1 Press TITLE.**
The title menu appears on the TV screen. The contents of the menu vary from disc to disc.
- 2 Press $\leftarrow/\uparrow/\downarrow/\rightarrow$ to select the title you want to play.**
Depending on the disc, you can use the number buttons to select the title.
- 3 Press ENTER.**
The player starts playing the selected title.

Notes

- Depending on the DVD, you may not be able to select the title.
- Depending on the DVD, a “title menu” may simply be called a “menu” or “title” in the instructions supplied with the disc. “Press ENTER.” may also be expressed as “Press SELECT.”

Using the DVD menu

Some DVDs allow you to select the disc contents using the menu. When you play these DVDs, you can select the language for the subtitles, the language for the sound, etc., using the DVD menu.

- 1 Press DVD MENU.**
The DVD menu appears on the TV screen. The contents of the menu vary from disc to disc.
- 2 Press $\leftarrow/\uparrow/\downarrow/\rightarrow$ to select the item you want to change.**
Depending on the disc, you can use the number buttons to select the item.
- 3 To change other items, repeat Step 2.**
- 4 Press ENTER.**

 If you want to select the language for the DVD menu Change the setting using “LANGUAGE SETUP” in the setup display. For details, see page 45.

Note

Depending on the DVD, a “DVD menu” may simply be called a “menu” in the instructions supplied with the disc.

Playing VIDEO CDs with PBC Functions (PBC Playback)



When playing VIDEO CDs with PBC functions (Ver. 2.0 discs), you can enjoy simple interactive operations, operations with search functions, etc. PBC Playback allows you to play VIDEO CDs interactively, following the menu screen on the TV screen. On this player, you can use the number buttons, ENTER, **◀▶**, **▶▶**, **↑/↓** and **↶** RETURN during PBC Playback.

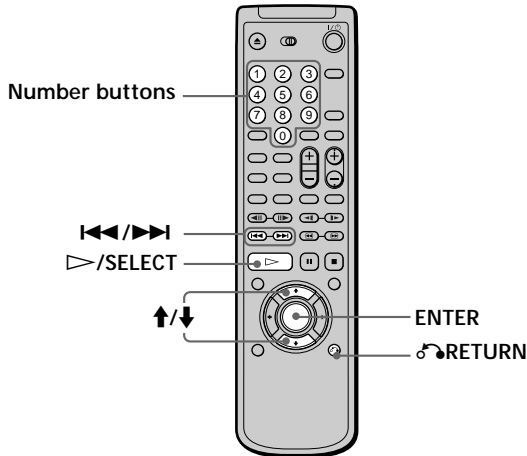

Going back to the menu screen

Press **↶** RETURN, **◀▶** or **▶▶**.



When playing VIDEO CDs with PBC functions PBC playback starts automatically.



To cancel PBC playback of a VIDEO CD with PBC functions and play the disc in Continuous Play mode

There are two ways.

- Before you start playing, select the track you want using **◀▶** or **▶▶**, then press ENTER or **>**.
- Before you start playing, select the track number using the number buttons on the remote, then press ENTER or **>**.
“Play without PBC” appears on the TV screen and the player starts Continuous Play. You cannot play still pictures such as a menu screen.
To return to PBC playback, press **■** twice then press **>**.

Note

Depending on the VIDEO CD, “Press ENTER.” in Step 3 may be expressed as “Press SELECT.” in the instructions supplied with the disc.

- 1 Start playing a VIDEO CD with PBC functions, following Steps 1 to 4 in “Playing Discs” on page 18.
- 2 Press the number button of the item you want. You can select the item also by using **↑/↓**.
- 3 Press ENTER.
- 4 Follow the instructions on the menu screen for interactive operations. Refer to the instructions supplied with the disc, as the operating procedure may differ according to the VIDEO CD.

Using the Front Panel Display



You can check information about the disc, such as the total number of the titles or the tracks or remaining time, using the front panel display.

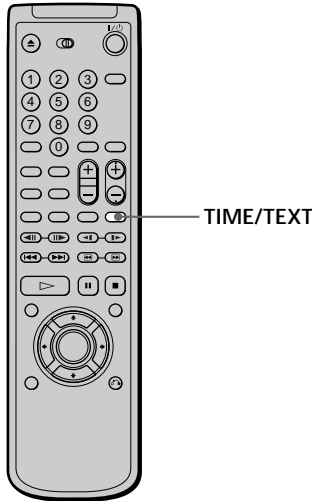

TIME/TEXT

When playing back a DVD **DVD**

Display information while playing the disc

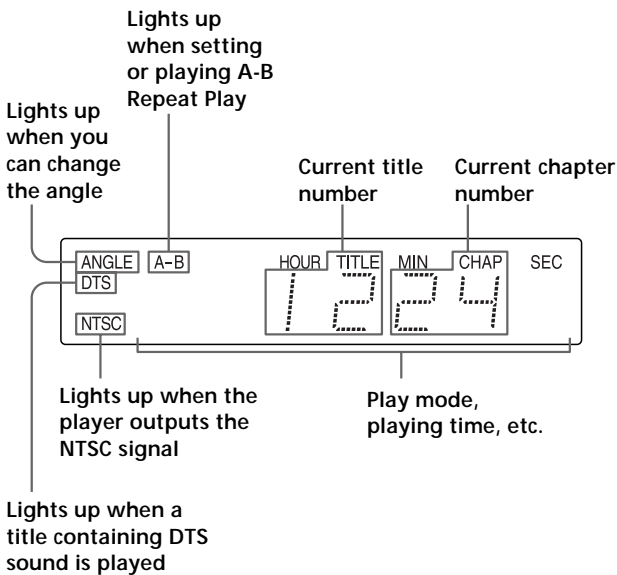

Checking the remaining time

Press TIME/TEXT.

Each time you press TIME/TEXT while playing the disc, the display changes as shown in the following chart.

Playing time of the current chapter



Remaining time of the current chapter

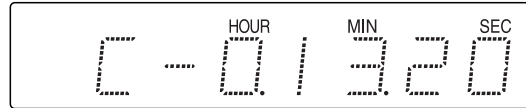

Playing time of the current title

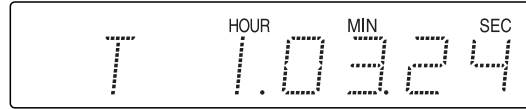

Remaining time of the current title

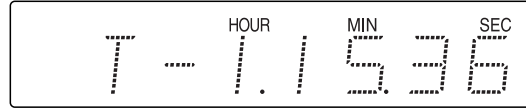

Text

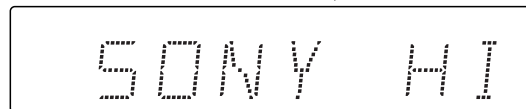

Current title and chapter number



Automatically

Notes

- Depending on the DVD, the chapter number or time may not appear or you may not be able to change the front panel display.
- While you are doing Shuffle Play or Program Play, the playing time of the title and the remaining time of the title are not displayed.

When playing back a CD/VIDEO CD



Display information while playing a disc

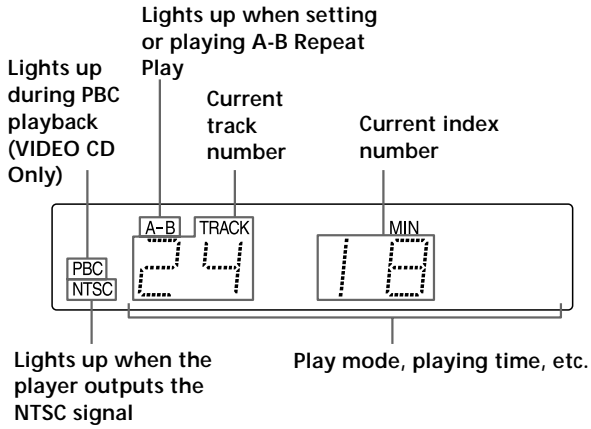

When playing VIDEO CDs with PBC functions

The current scene number is displayed instead of the current track number and the current index number. In this case, the front panel display does not change when you press TIME/TEXT. If the TEXT is recorded in the disc, the front panel display changes to Text display when you press TIME/TEXT (see page 31).

Checking the remaining time

Press TIME/TEXT.

Each time you press TIME/TEXT while playing a disc, the display changes as shown in the following chart.

Playing time of the current track

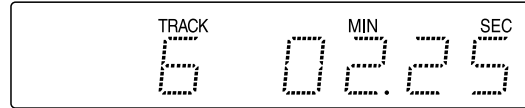

Remaining time of the current track

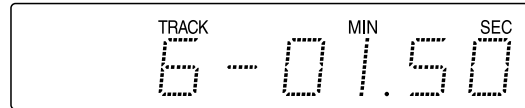

Playing time of the disc

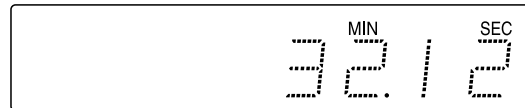

Remaining time of the disc

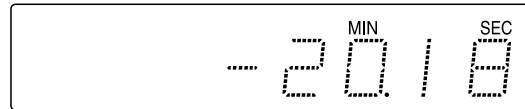

Text

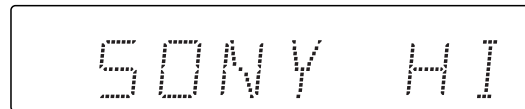

Current track and index number



Automatically

Note

While you are doing Shuffle Play, Program Play, or PBC playback, the playing time of the disc and the remaining time of the disc are not displayed.

Using Various Functions with the Control Menu

This chapter describes how to play discs in various modes and how to use the convenient features of the on-screen menu (Control Menu).

Using the Control Menu Display



Using the Control Menu display, you can select the start point, play in a order you like, change the angles, set for Digital Cinema Sound, etc.

The items are different depending on the kind of disc. For details on each Control Menu display item, see pages 29 to 41.

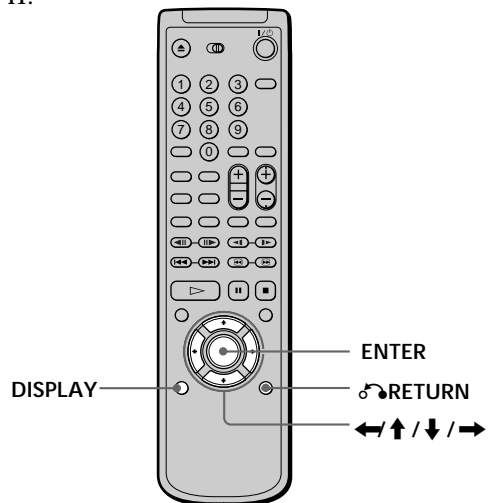

- 1 Press DISPLAY to show the Control Menu display on the TV screen.

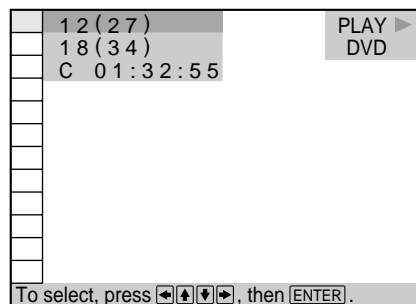

- 2 Select the item you want using \uparrow/\downarrow , then press \rightarrow or ENTER.

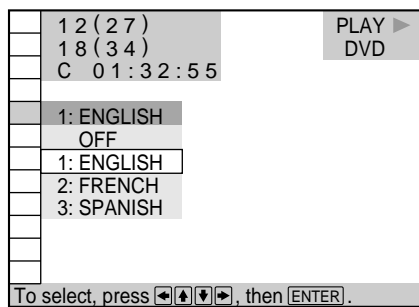
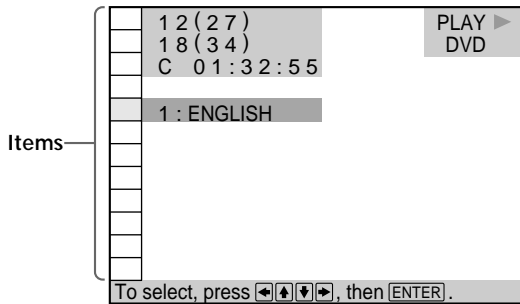

Note

Some Control Menu display items require operations other than selecting the setting. For details on these items, see the relevant pages.

To cancel using the Control Menu display on the way

Press \rightarrow RETURN.

To display other items

Each time you press DISPLAY, the Control Menu display changes as follows:

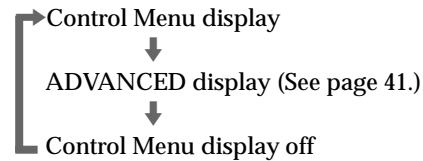

You can display some items using the remote

Some items can be displayed by pressing the button of the remote. In this case, only the item you selected is displayed. For the item and operations using the remote, see the pages of each item.

- 3 Select the item you want using \uparrow/\downarrow , then press ENTER.

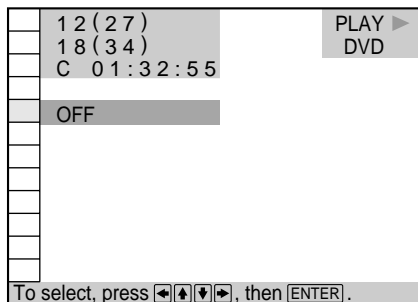
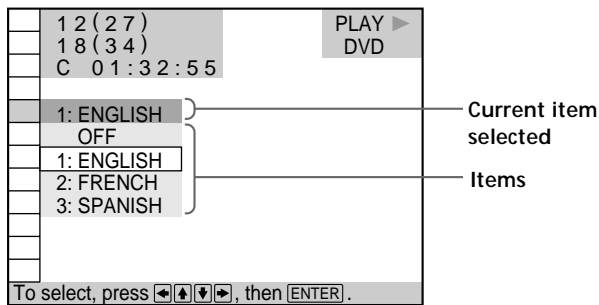

Control Menu Item List

TITLE (DVD only) (page 29)

CHAPTER (DVD only) (page 29)

TRACK (VIDEO CD/CD only) (page 29)

INDEX (VIDEO CD/CD only) (page 29)

SCENE (VIDEO CD during PBC playback only)

(page 29)

You can search by selecting the title/chapter/track/index/scene.

TIME/TEXT (page 30, 31)

You can check the playing time and remaining time of the current title/chapter/track and the total remaining time of the disc.

You can search by inputting the time code.

You can check the DVD TEXT or CD TEXT of the disc on the TV screen and the front panel display.

AUDIO (page 32)

With DVDs recorded with multilingual sounds, you can select the language you want while playing the DVD. With multiplex CDs or VIDEO CDs, you can select the sound from the right or left channel and listen to the sound of the selected channel through both the right and left speakers.

SUBTITLE (DVD only) (page 33)

With DVDs on which multilingual subtitles are recorded, you can change the subtitle language whenever you want while playing the DVD, and turn it on or off whenever you want.

ANGLE (DVD only) (page 34)

With DVDs on which various angles (multi-angles) are recorded, you can change the angles on the scene for which multi-angles are recorded.

VES (page 35)

Select the mode to enjoy multichannel surround sound such as Dolby Digital and MPEG.

Even if you connect only front speakers, Virtual Enhanced Surround (VES) lets you enjoy 3D sound by using 3D sound imaging to create virtual rear speakers from the sound of the front speakers (L, R) without using actual rear speakers.

You can feel the more effective 3D sound when you connect a receiver (amplifier) with digital (optical or coaxial) input, 2 front speakers, 2 rear speakers, 1 center speaker and 1 subwoofer.

PROGRAM (page 36)

You can play the contents of the disc in the order you want by arranging the order of the titles, chapters or tracks on the disc to create your own program.

SHUFFLE (page 38)

You can have the player “shuffle” titles, chapters or tracks and play them in a random order. The playing order may differ from the previous “shuffling.”

REPEAT (page 39)

You can play all the titles/tracks on a disc or a single title/chapter/track repeatedly.

A-B REPEAT (page 39)

You can play a specific portion of a title, chapter, or track repeatedly.

ADVANCED (DVD only) (page 41)

You can check the play information about the bit rate, bit rate history or the position where the disc is played (layer).

Searching for the Title/Chapter/Track/Index/Scene



You can search by selecting the title/chapter/track/index/scene.

Select "TITLE," "CHAPTER," "TRACK," "INDEX" or "SCENE" after pressing DISPLAY.

When you play back a DVD, "TITLE" and "CHAPTER" are displayed.

When you play back a VIDEO CD/CD, "TRACK" and "INDEX" are displayed. When you play back a VIDEO CD with PBC functions, "SCENE" is displayed.

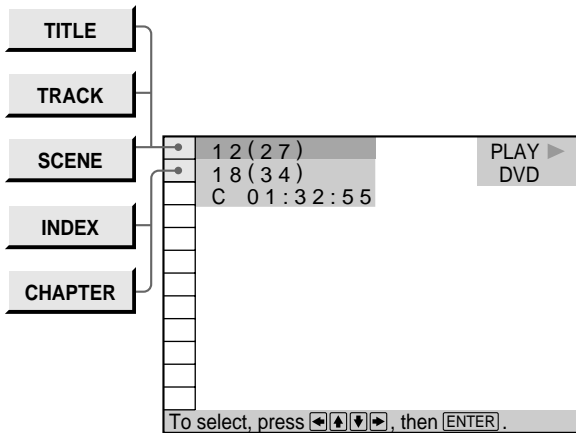

1 Select "TITLE," "CHAPTER," "TRACK," "INDEX" or "SCENE" using **↑/↓**.

"** (**)" is highlighted. (** means optional number in this manual.) Number in parentheses indicate the total number of titles, chapters, tracks, indexes or scenes.

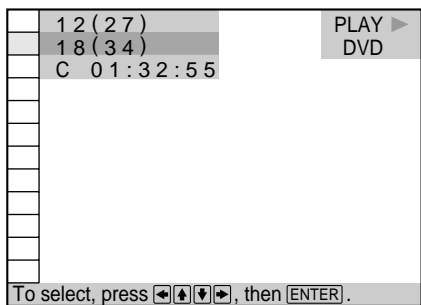

2 Press **→** or **ENTER**.

"** (**)" is changed to "-- (**)."

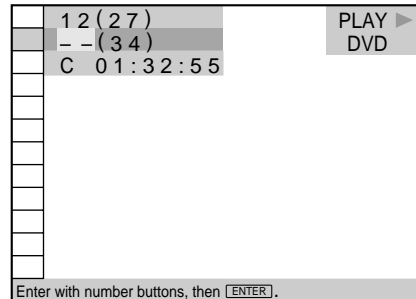

3 Select the number of the title, chapter, track, index or scene you want to search for using the number buttons, then press **ENTER**.

The player starts searching. To cancel the number, press **CLEAR** before pressing **ENTER**.

To cancel selecting

Press **↩**RETURN.

Notes

- The number of titles, chapters or tracks displayed is that of the titles, chapters or tracks recorded on a disc.
- The index numbers are not displayed during PBC playback of VIDEO CDs.

Checking the Playing Time and Remaining Time



DVD

VIDEO CD

CD

You can check the playing time and remaining time of the current title/chapter/track and the total remaining time of the disc.

Press DISPLAY. Then press TIME/TEXT on the remote to change the time information.

You can also check the DVD TEXT and CD TEXT. See page 31.

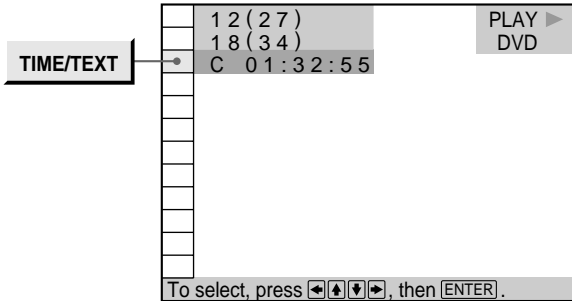

When playing a DVD

■ TIME/TEXT

- C * * * * * : Playing time of the current chapter
- C - * * * * * : Remaining time of the current chapter
- T * * * * * : Playing time of the current title
- T - * * * * * : Remaining time of the current title

When playing a VIDEO CD (during PBC playback)

■ TIME/TEXT

- * * * * * : Playing time of the current scene

When playing a VIDEO CD (in Continuous play) or CD

■ TIME/TEXT

- T * * * * * : Playing time of the current track
- T - * * * * * : Remaining time of the current track
- D * * * * * : Playing time of the current disc
- D - * * * * * : Remaining time of the current disc



You can display "TIME/TEXT" display quickly

Press TIME/TEXT on the remote. Each time you press the button, the time information changes.

Selecting a Start Point Using the Time Code



DVD

You can search by inputting the time code.

Select "TIME/TEXT" after pressing DISPLAY.

The time code corresponds to the approximate actual playing time. For example, to search for a scene 2 hours 30 minutes 20 seconds past the beginning, input 2:30:20.

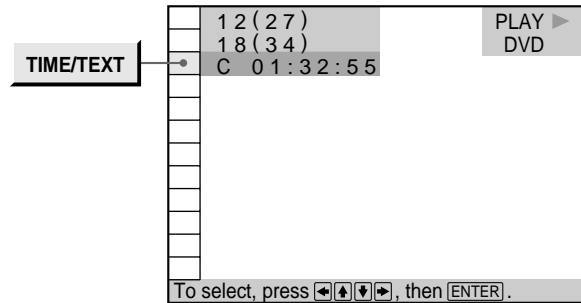

- 1 Select "C * * * * * " (playing time of the current chapter).

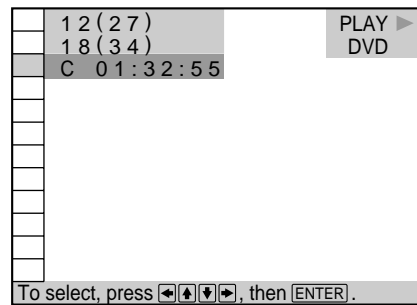

- 2 Press → or ENTER.

Time code changes to "T - - : - - : - -."

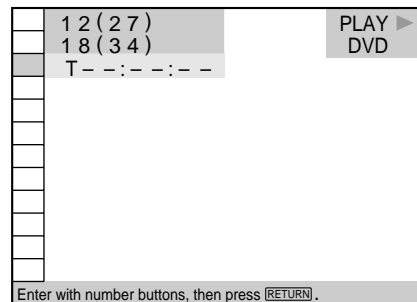

- 3** Input the time code using the number buttons, then press ENTER.
The player starts searching. To cancel the number, press CLEAR before pressing ENTER.

To cancel inputting

Press RETURN.

Note

When you input the time code, input the playing time of the title.

Checking the Information of the Disc



You can check the DVD TEXT or CD TEXT of the disc on the TV screen and the front panel display. DVD TEXT and CD TEXT are information recorded on the disc which you cannot change. Press DISPLAY. Then press TIME/TEXT on the remote until DVD/CD TEXT is displayed. The information is displayed at the bottom of the display.

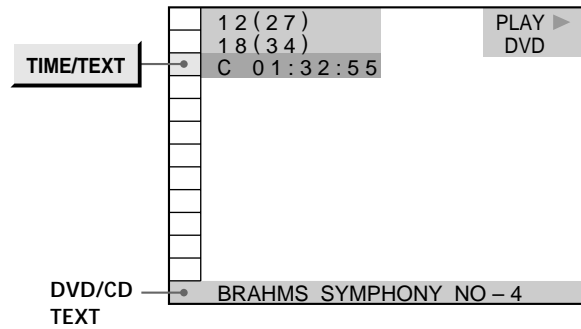

You can display "TIME/TEXT" display quickly. Press TIME/TEXT on the remote. To display DVD/CD TEXT, press TIME/TEXT until DVD/CD TEXT is displayed.

Note

The DVD TEXT only in English is displayed.

Changing the Sounds



With DVDs recorded with multilingual sounds, you can select the language you want while playing the DVD. With multiplex CDs or VIDEO CDs, you can select the sound from the right or left channel and listen to the sound of the selected channel through both the right and left speakers. In this case, the sound loses the stereo effect. For example, with a disc containing a song, the right channel may output the vocals and the left channel may output the instrumental. If you only want to hear the instrumental, you can select the left channel and hear it from both speakers.

Select "AUDIO" after pressing DISPLAY.

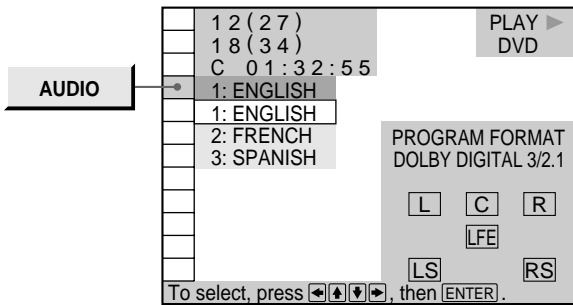

AUDIO

When playing a DVD

Select the language. The languages you can select are different depending on the DVD. When 4 digits are displayed, they represent the language code. Select the language code from the list on page 63.

When playing a VIDEO CD or a CD

Default setting is underlined.

- STEREO : The standard stereo sound
- 1/L : The sound of the left channel (monaural)
- 2/R : The sound of the right channel (monaural)

You can display "AUDIO" display quickly
Press AUDIO on the remote.

Notes

- Depending on the DVD, you may not be able to change the languages even if multilingual sounds are recorded on the DVD.
- While playing the CD/VIDEO CD, the standard stereo playback will be resumed when:
 - you eject the disc
 - you turn the power off
- While playing the DVD, the sound may be changed when:
 - you eject the disc
 - you change the title
- If the language is displayed as a 4 digit number, refer to the language code list on page 63.

Displaying the audio information of the disc

When you select "AUDIO," the playing channels are displayed on the screen.

In Dolby Digital format, the signals from monaural to 5.1 channels can be recorded on a DVD. Depending on the DVD the number of the recorded channels may be different.

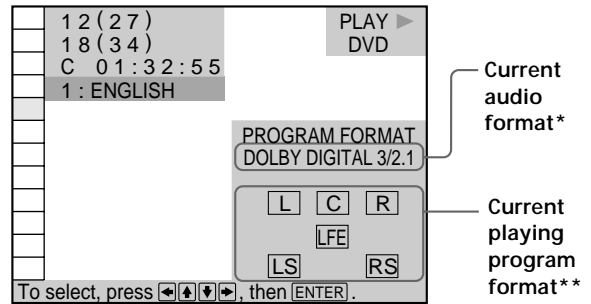

* "PCM," "DTS," "DOLBY DIGITAL" or "MPEG" is displayed. In "DOLBY DIGITAL" case, the channels in the playing track are displayed by number as follows:

The case of Dolby Digital 5.1 ch:

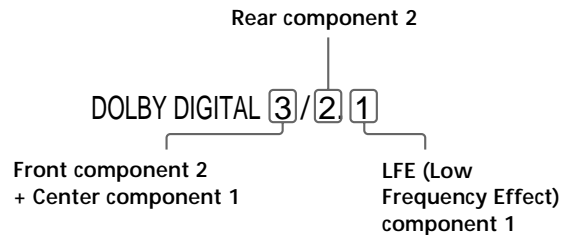

** The letters in the program format display mean the following:

- L: Front (L)
- R: Front (R)
- C: Center (monaural)
- LS: Rear (L)
- RS: Rear (R)
- S: Rear (monaural) – the rear component of the Dolby Surround processed stereo signal and the Dolby Digital signal.
- LFE: – LFE (Low Frequency Effect)

Displaying the Subtitles



The display examples are as follows:

•PCM (stereo)

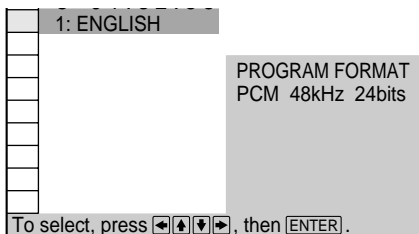

•Dolby Surround

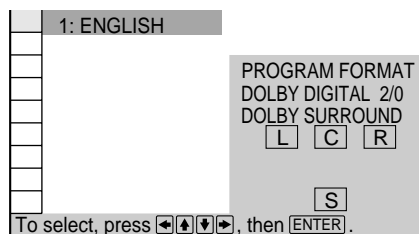

•Dolby Digital 5.1ch

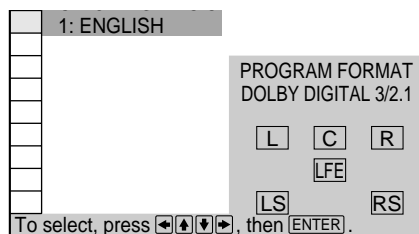

•DTS

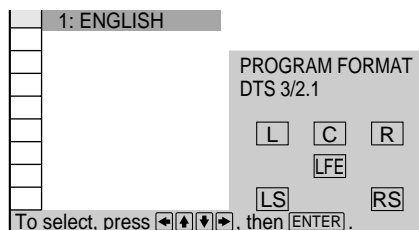

•MPEG

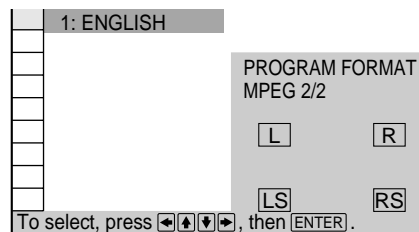

You can find Dolby Surround-encoded software by looking at the packaging

Use discs with the logo. In order to enjoy Dolby Digital playback you must use discs bearing this logo.

With DVDs on which subtitles are recorded, you can turn the subtitles on and off whenever you want while playing the DVD.

With DVDs on which multilingual subtitles are recorded, you can change the subtitle language whenever you want while playing the DVD, and turn it on or off whenever you want. For example, you can select the language you want to master and turn the subtitles on for better understanding.

Select "SUBTITLE" after pressing DISPLAY.

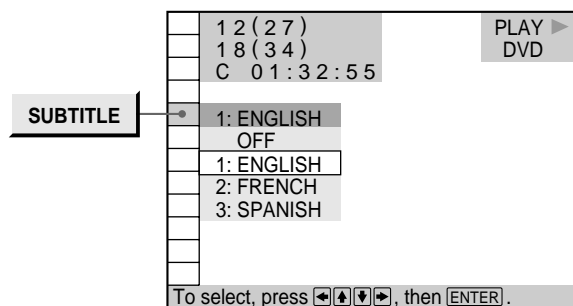

■SUBTITLE

Select the language. The languages you can select are different depending on the DVD. When 4 digits are displayed, they indicate the language code. Select the language code from the list on page 63.

You can display the "SUBTITLE" display quickly
Press SUBTITLE on the remote. Each time you press the button, the item changes.

Notes

- When playing a DVD on which no subtitles are recorded, no subtitles appear.
- Depending on the DVD, you may not be able to turn the subtitles on even if they are recorded on it.
- Depending on the DVD, you may not be able to turn the subtitles off.
- If the language is displayed as a 4-digit number, refer to the language code list on page 63.
- The type and number of languages for subtitles vary from disc to disc.
- Depending on the DVD, you may not be able to change the subtitles even if multilingual subtitles are recorded on it.
- While playing the DVD, the subtitle may change when:
 - you eject the disc
 - you change the title

Changing the Angles DVD

With DVDs on which various angles (multi-angles) for a scene are recorded, you can change the angles. For example, while playing a scene of a train in motion, you can display the view from either the front of the train, the left window of the train or from the right window without having the train's movement interrupted. Select "ANGLE" after pressing DISPLAY. When the angles can be changed, the indicator of the "ANGLE" lights in green.

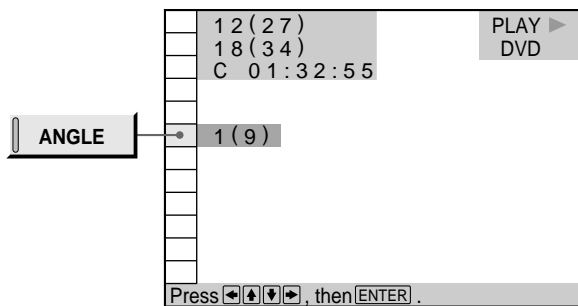

1 Select "ANGLE."

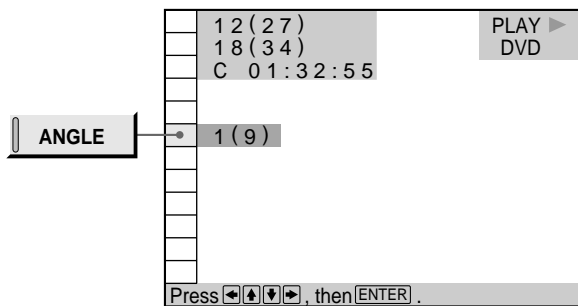

2 Press →.

The number of the angle changes to "-." The number in parentheses indicates the total number of angles.

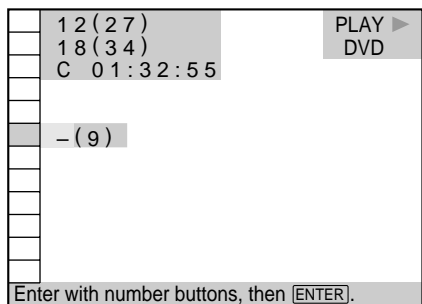

- 3 Select the number of the angles using the number buttons or ↑/↓, then press ENTER. The angle is changed to the selected angle.

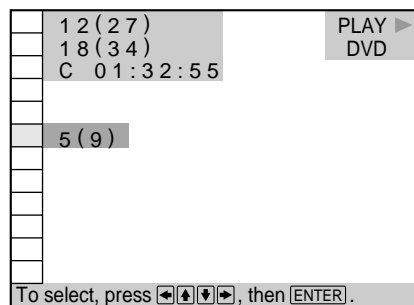

Notes

- The number of angles varies from disc to disc or from scene to scene. The number of angles that can be changed on a scene is that of angles recorded for that scene.
- Depending on the DVD, you may not be able to change the angles even if multi-angles are recorded on the DVD.

You can specify the angle beforehand

Specify the angle when "ANGLE" is not displayed on the front panel display. When a scene on which multi-angles are recorded comes, the angle is automatically selected.

You can select the angle directly

Press ANGLE on the remote. Each time you press the button, the angle changes.

Setting for Digital Cinema Sound



Select the mode to enjoy multichannel surround sound such as Dolby Digital and MPEG.
 Even if you connect only front speakers, Virtual Enhanced Surround lets you enjoy 3D sound by using 3D sound imaging to create virtual rear speakers from the sound of the front speakers (L, R) without using actual rear speakers.
 You can feel the more effective 3D sound when you connect a receiver (amplifier) with digital (optical or coaxial) input, 2 front speakers, 2 rear speakers, 1 center speaker and 1 subwoofer.
 Select "VES" after pressing DISPLAY. When you select the item except "OFF," the indicator of the "VES" lights in green.

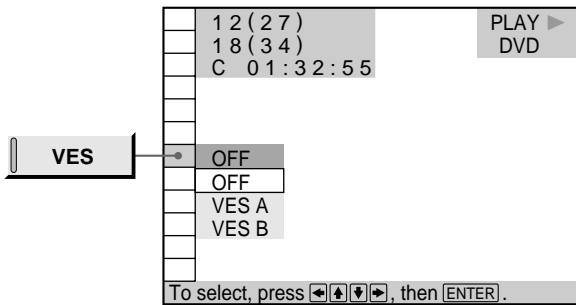

■ VES

Select the desired item. For details on each item, see "Effects of each item."

Default setting is underlined.

- OFF
- VES A
- VES B

Effects of each item

OFF

Outputs 2-channel signals for stereo sound of the CD. 5-channel signals for Dolby Digital sound of the DVD are mixed down to 2-channel to be output.

VES (Virtual Enhanced Surround) A

Uses 3D sound imaging to create virtual rear speakers from the sound of the front speakers (L, R) without using actual rear speakers. The virtual speakers are reproduced as shown in the illustration below.

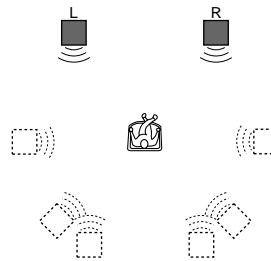

VES (Virtual Enhanced Surround) B

Uses 3D sound imaging to create virtual rear speakers from the sound of the front speakers (L, R) without using actual rear speakers. The virtual speakers are reproduced as shown in the illustration below.

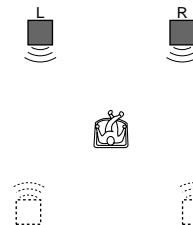

Notes

- You cannot select "VES" when "DOLBY DIGITAL" is set to "DOLBY DIGITAL" in "AUDIO SETUP."
- In case that the player outputs the signal from OPTICAL and COAXIAL, the surround effect will be heard only when you set "MPEG" to "PCM" in "AUDIO SETUP."
- Some discs do not have rear sound. In this case, you cannot get the 3D surround effect.
- When you select an item, the sound cuts off for a moment.
- When the playing signal does not contain the surround component, the effects may be difficult to hear even if you select "VES A" or "VES B."
- Set the front speakers to form an equilateral triangle including the listening position, or the effects may be difficult to hear even if you select "VES A" or "VES B."
- When you connect a subwoofer, you can also hear the sound from the subwoofer.
- When you select "VES A" or "VES B," set the surround settings of the connected units such as the amplifier to OFF.

Creating Your Own Program (Program Play)



DVD

VIDEO CD

CD

You can play the contents of the disc in the order you want by arranging the order of the titles, chapters or tracks on the disc and create your own program. One program can be restored in the player and contain up to 99 titles, chapters and tracks.

Select "PROGRAM" after pressing DISPLAY. When you select "ON," the indicator of the "PROGRAM" lights in green.

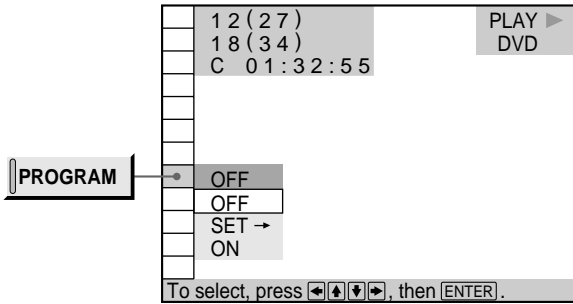

PROGRAM

Default setting is underlined.

- OFF: plays normal.
- SET ->: allows you to create your own program.
- ON: plays Program Play.

Creating the program

1 Select "SET ->" in "PROGRAM."

The programming display appears.

"TRACK" is displayed when you play a VIDEO CD or a CD.

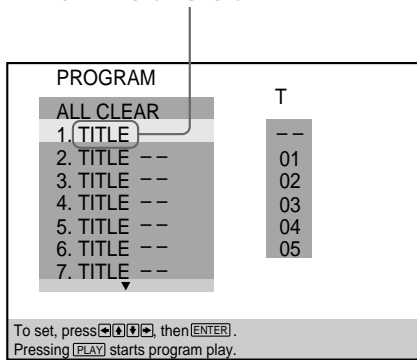

2 Press ->.

"01" is highlighted. It is ready to set the first title or track for program.

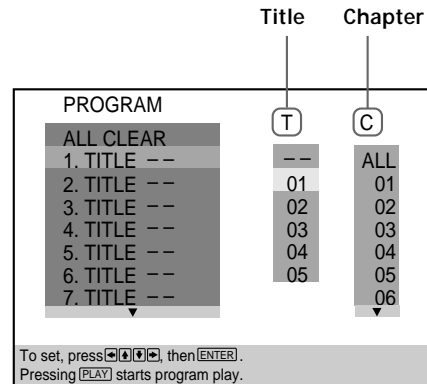

3 Select the title, chapter or track you want to program using up/down, then press ENTER.

For example, select title or track 2.

(You can also use the number buttons and ENTER button to select. In this case, the selected number is displayed on the screen.)

When playing a DVD

When both titles and chapters are recorded on the disc, select the title, then the chapter.

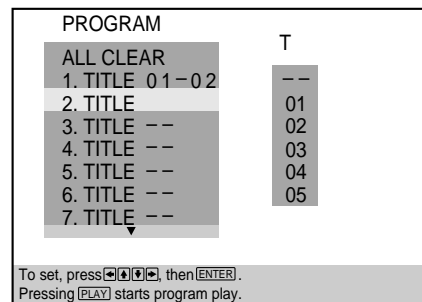
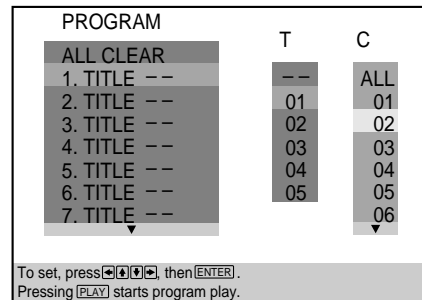

- **When playing a VIDEO CD or CD**
Select the track you want to program.

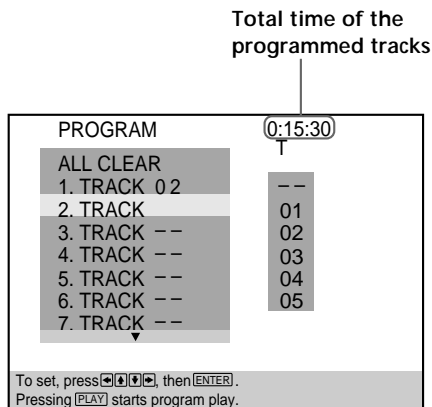

- To program other titles, chapters or tracks, repeat Step 3.
The programmed titles, chapters or tracks are displayed from 2 in order.

- Press \triangleright to start Program Play.

To cancel Program Play

Press CLEAR.

To cancel programming

Press PROGRAM.

To change programming

- In Step 2, select the program number of the title, chapter or track you want to change using \uparrow/\downarrow .
- Follow Step 3 for new programming.

To cancel the programmed order

To cancel all the titles, chapters or tracks in the programmed order, select "ALL CLEAR" in Step 2.
To cancel the selected program, select the program using \uparrow/\downarrow in Step 2 then press CLEAR, or select "--" in Step 3 then press ENTER.

The program remains even after the Program Play ends
When you press \triangleright , you can play the same program again.

You can do Repeat Play or Shuffle Play of the programmed titles, chapters or tracks
During Program Play, press REPEAT or SHUFFLE. Or set "REPEAT" or "SHUFFLE" to "ON" in the Control Menu display.

You can display "PROGRAM" display quickly
Press PROGRAM on the remote.

You can select discs, titles, chapters and tracks for the program by looking at the front panel display
You can program by looking at the front panel display instead of using the programming display on the TV screen.
When you select Track 3 in a VIDEO CD for Program 1, the front panel display will appear as follows:

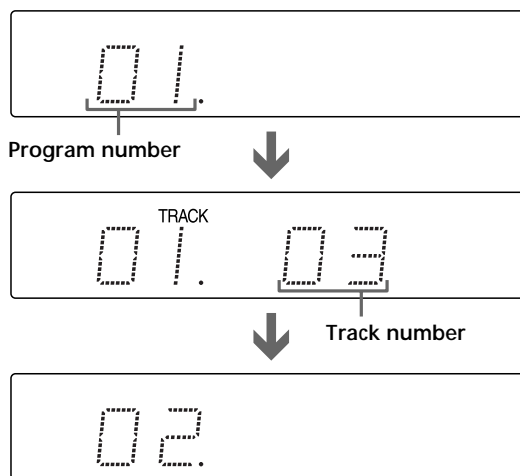

Notes

- The program is canceled when:
 - you eject the disc
 - you turn the power off
- You may not be able to do Program Play depending on the DVD.
- While you are doing PBC playback, you cannot set a program unless you stop playback once.

Playing in Random Order (Shuffle Play)



DVD

VIDEO CD

CD

You can have the player “shuffle” titles or tracks and play them in a random order. The playing order may differ from the previous “shuffling.”

Select “SHUFFLE” after pressing DISPLAY. When you do not select “OFF,” the indicator of the “SHUFFLE” lights in green.

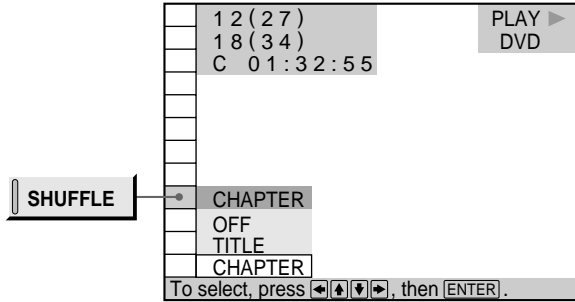

You can set Shuffle Play during stop
After selecting the item of “SHUFFLE,” press \triangleright .
The player starts Shuffle Play.

You can display the “SHUFFLE” display quickly
Press SHUFFLE on the remote.

Notes

- Shuffle Play is canceled when:
 - you eject the disc
 - you turn the power off
- You may not be able to do Shuffle Play depending on the DVD.
- Up to 200 chapters in a disc can be played in a random order when “CHAPTER” is selected.

■ SHUFFLE

Selects the setting of Shuffle Play.
Default settings are underlined.

When playing a DVD and when Program Play is set to OFF

- OFF: does not play a disc in random order.
- TITLE: has the player “shuffle” titles and play in a random order.
- CHAPTER: has the player “shuffle” chapters and play in a random order.

When playing a VIDEO CD, CD or DVD (when Program Play is set to ON)

- OFF: does not play a disc in random order.
- ON: has the player “shuffle” titles or tracks and play in a random order.

When playing a VIDEO CD or CD (when Program Play is set to OFF)

- OFF: does not play a disc in random order.
- TRACK: has the player “shuffle” tracks and play in a random order.

To cancel Shuffle Play

Press CLEAR.

Playing Repeatedly (Repeat Play)



DVD

VIDEO CD

CD

You can play all the titles/tracks on a disc or a single title/chapter/track.

In Shuffle or Program Play mode, the player repeats the titles or tracks in the shuffled or programmed order.

You cannot do Repeat Play during PBC playback of VIDEO CDs (page 23).

You may not be able to do Repeat Play depending on the DVD.

Select "REPEAT" after pressing DISPLAY. When you do not select "OFF," the indicator of the "REPEAT" lights in green.

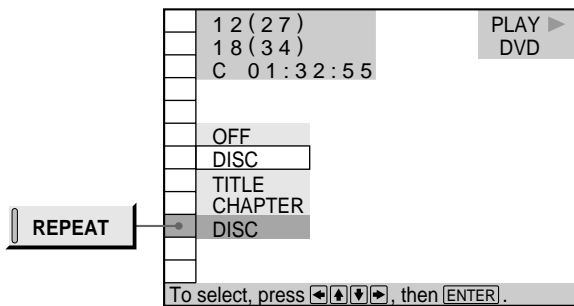

REPEAT

Selects the setting of Repeat Play.
Default settings are underlined.

When playing a DVD and when Program Play and Shuffle Play are set to OFF

- OFF: does not play repeatedly.
- DISC: repeats all the titles.
- TITLE: repeats the current title on a disc.
- CHAPTER: repeats the current chapter.

When playing a VIDEO CD/CD and when Program Play and Shuffle Play are set to OFF

- OFF: does not play repeatedly.
- DISC: repeats all the tracks on a disc.
- TRACK: repeats the current track.

When Program Play or Shuffle Play is set to ON

- OFF: does not play repeatedly.
- ON: repeats Program Play or Shuffle Play.

To cancel Repeat Play

Press CLEAR.

You can set Repeat Play during stop
After selecting the item of "REPEAT," press \triangleright .
The player starts Repeat Play.

You can display the "REPEAT" display quickly
Press REPEAT on the remote.

Note

Repeat play is canceled when you turn the power off.

Repeating a Specific Portion (A↔B Repeat)



DVD

VIDEO CD

CD

You can play a specific portion of a title, chapter, track repeatedly. This is useful when you want to memorize lyrics.

During PBC Playback of VIDEO CDs (page 23), this function is available only while playing moving pictures. You may not be able to do A↔B Repeat Play depending on the DVD.

Select "A-B REPEAT" after pressing DISPLAY. During A↔B Repeat Play, the indicator of the "A-B REPEAT" lights in green.

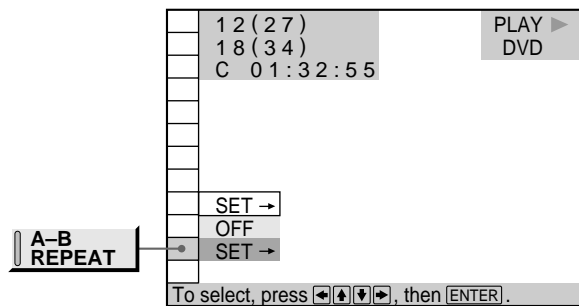

A-B REPEAT

Default setting is underlined.

- SET→: sets the A and B points.
- OFF: does not play a specific portion of a title/chapter/track repeatedly.

Repeating a Specific Portion (A↔B Repeat)

Setting a portion for A↔B repeat

- 1 Select "SET→" in "A-B REPEAT."
The A↔B REPEAT setting display appears.

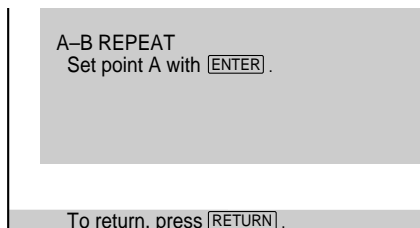
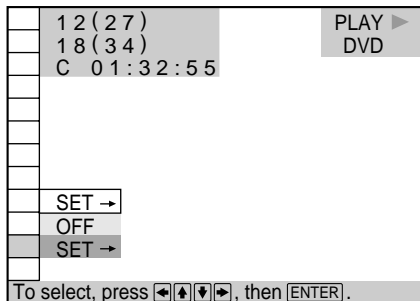

- 2 During playback, when you find the starting point (point A) of the portion to be played repeatedly, press ENTER.
The starting point (point A) is set.

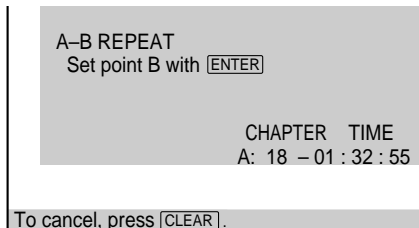

- 3 When you reach the ending point (point B), press ENTER again.
The setting points are displayed and the player starts repeating this specific portion.
"A-B" appears on the front panel display during A↔B repeat play.

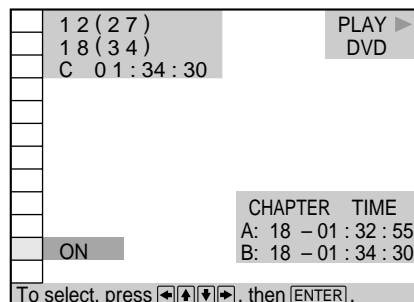

To cancel A↔B Repeat Play

Press CLEAR.

You can display the A↔B Repeat setting display quickly. Press A↔B on the remote.

Notes

- You can set A↔B Repeat on only one specific portion.
- A↔B Repeat is canceled when:
 - you eject the disc
 - you turn the power off
- When you set A↔B Repeat, the settings for Shuffle Play and Program Play are canceled.
- You may not be able to set A↔B Repeat, depending on the scene of the DVD or the VIDEO CD.

Checking the Play Information DVD

You can check the play information on the bit rate, bit rate history or the portion where the disc is played (layer). While playing a disc, the approximate bit rate of the playback picture is always displayed by Mbps (Mega bit per second) and the audio by kbps (kilo bit per second). Select "ADVANCED" after pressing DISPLAY.

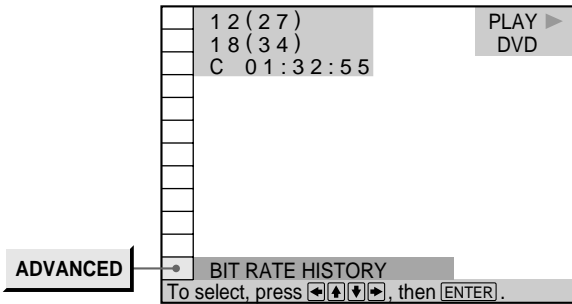

■ ADVANCED

Default setting is underlined.

When playing a DVD

- **BIT RATE**: displays bit rate.
- **BIT RATE HISTORY**: displays bit rate and bit rate history.
- **LAYER**: displays layer and the point picked up.
- **OFF**: turns off ADVANCED display.

Displays of each item

BIT RATE

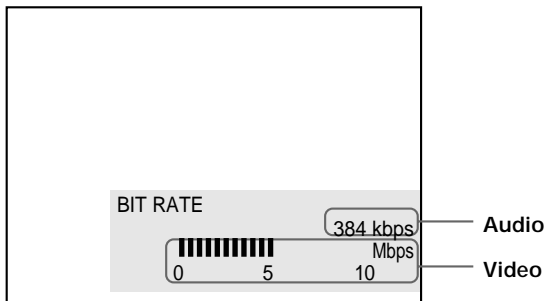

When you play MPEG AUDIO sound tracks

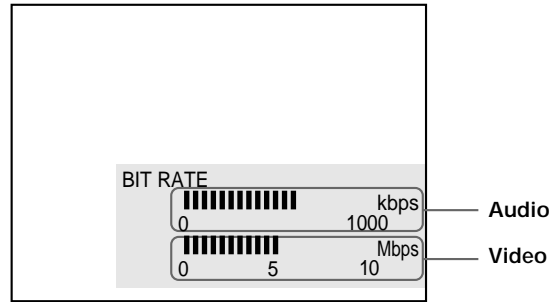

Bit rate refers to the amount of video/audio data per second in a disc. The higher the bit rate is, the larger the amount of data. When the bit rate level is high, there is a large amount of data. However, this does not always mean that you can get higher quality pictures or sounds.

BIT RATE HISTORY

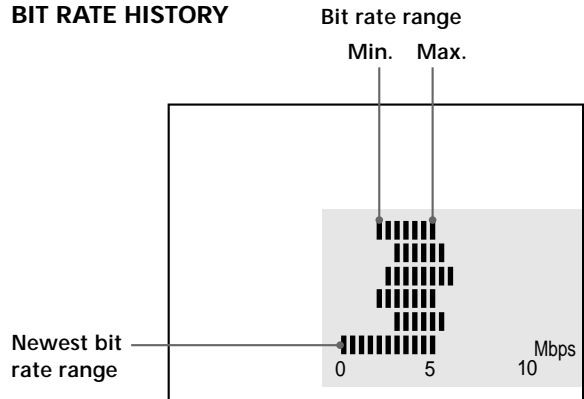

Indicates the transition of bit rate of the playback picture for a period up to the present.

LAYER

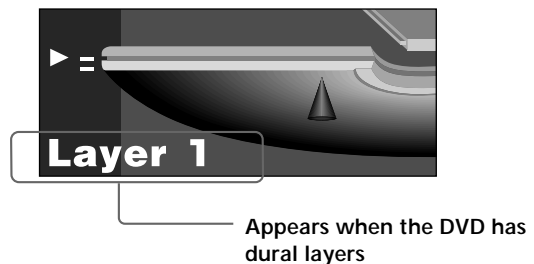

Indicates the approximate point where the disc is playing. If it is a dual-layer DVD, the player indicates which layer is being read.

For details on the layers, see page 61 (DVD).

Settings and Adjustments

This chapter describes how to set and how to adjust using the on-screen SET UP menu. Most settings and adjustments are required to be set when you first use the player. This chapter also describes how to set the remote for controlling the TV or the AV receiver (amplifier).

Using the Setup Display



Using the setup display, you can do the initial setup, adjusting the picture and sound quality, setting the various outputs, etc. You can also set a language for the subtitles and the setup display, limit playback by children, etc.

For details on each setup display item, see pages 45 to 53.

Note

You can display the setup display only when the player is in stop mode.

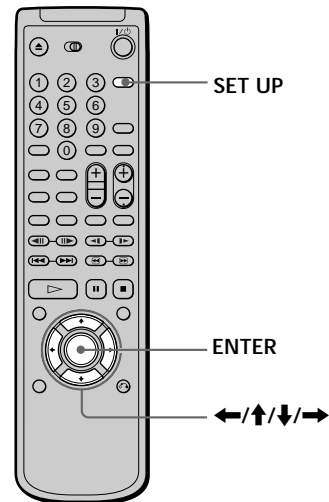

- 1 Press SET UP to display the setup display on the TV screen.

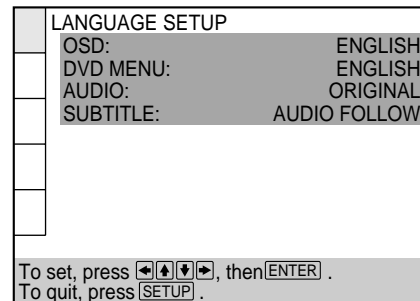

- 2** Select the main item you want using **↑/↓**, and then press **ENTER**.

The selected main item is highlighted.

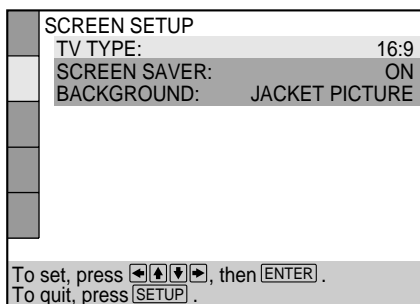
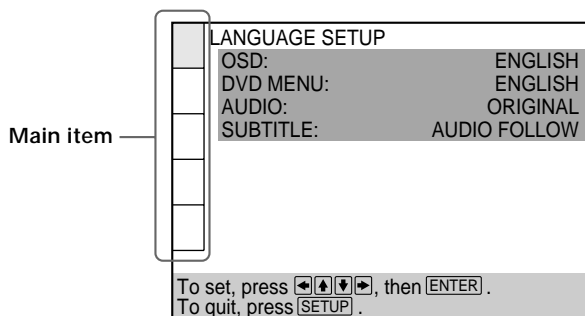

- 3** Select the item you want using **↑/↓**, then press **→** or **ENTER**.

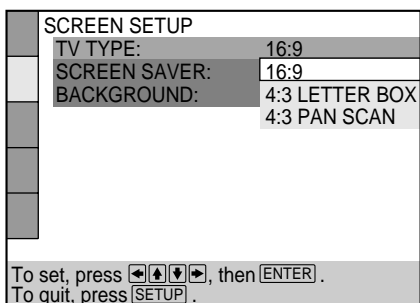
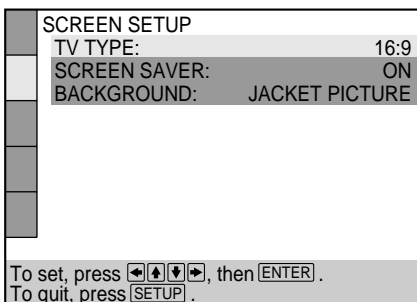

- 4** Select the setting you want using **←/↑/↓/→**, then press **ENTER**.

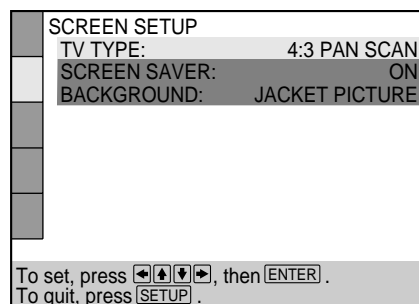
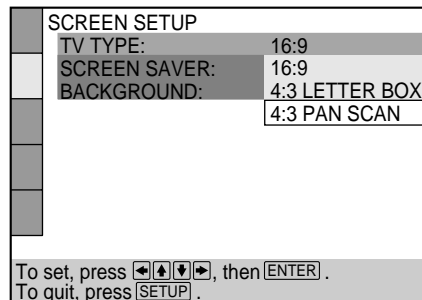

To cancel using the setup display on the way

Press **SET UP** on the remote.

Note

Some setup display items require operations other than selecting the setting. For details on these items, see the relevant pages.

Setup Display Item List

Default settings are underlined.

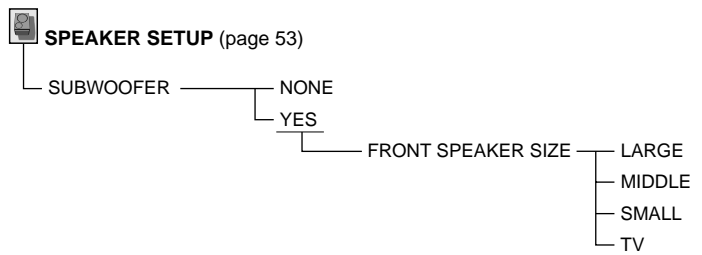
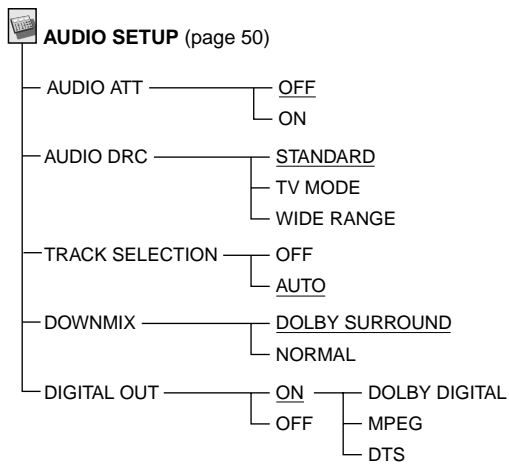
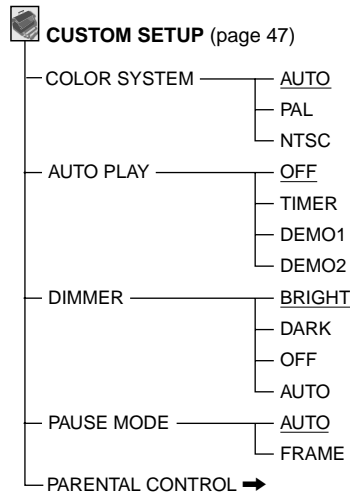
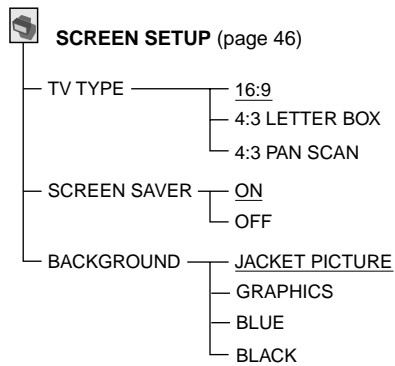
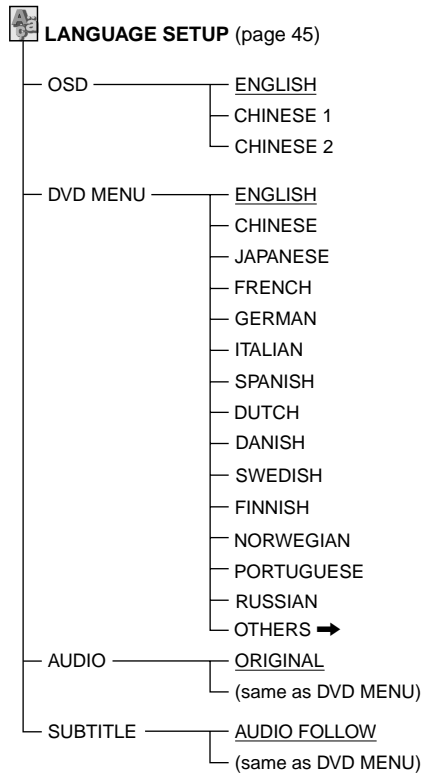

Setting the Language for Display and Sound (LANGUAGE SETUP)

Select "LANGUAGE SETUP" after pressing SET UP.
"LANGUAGE SETUP" allows you to set various languages for on-screen display or sound.
Default settings are underlined.

Note

When you select a language that is not recorded on the DVD, one of the recorded languages is automatically selected except for the "OSD."

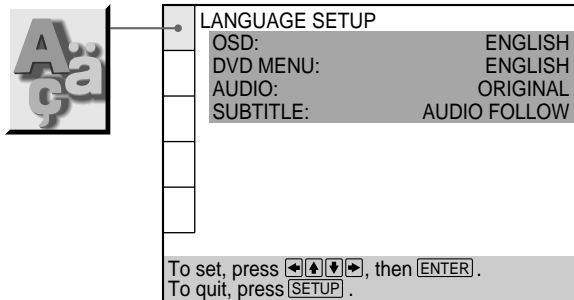

■ OSD (On-Screen Display)

Switches the language for the on-screen display.

- ENGLISH
- CHINESE 1
- CHINESE 2

■ DVD MENU

Switches the language for the DVD menu.

- ENGLISH
- CHINESE
- JAPANESE
- FRENCH
- GERMAN
- ITALIAN
- SPANISH
- DUTCH
- DANISH
- SWEDISH
- FINNISH
- NORWEGIAN
- PORTUGUESE
- RUSSIAN
- OTHERS➡

When you select "OTHERS➡," select and enter the language code from the list using the number buttons (page 63).
After you have once selected, the language code (4 digits) is displayed.

■ AUDIO

Switches the language for the sounds.

- ORIGINAL: the language given priority in the disc
- ENGLISH
- CHINESE
- JAPANESE
- FRENCH
- GERMAN
- ITALIAN
- SPANISH
- DUTCH
- DANISH
- SWEDISH
- FINNISH
- NORWEGIAN
- PORTUGUESE
- RUSSIAN
- OTHERS➡

When you select "OTHERS➡," select and enter the language code from the list using the number buttons (page 63).

After you have once selected, the language code (4 digits) is displayed.

■ SUBTITLE

Switches the language for the subtitles.

- AUDIO FOLLOW*
- ENGLISH
- CHINESE
- JAPANESE
- FRENCH
- GERMAN
- ITALIAN
- SPANISH
- DUTCH
- DANISH
- SWEDISH
- FINNISH
- NORWEGIAN
- PORTUGUESE
- RUSSIAN
- OTHERS➡

When you select "OTHERS➡," select and enter the language code from the list using the number buttons (page 63).

After you have once selected, the language code (4 digits) is displayed.

* When you select "AUDIO FOLLOW," the language for the subtitles changes according to the language for the setting you selected in "AUDIO."

Settings for Display (SCREEN SETUP)



Select "SCREEN SETUP" after pressing SET UP.
"SCREEN SETUP" allows you to set the display according to the playback conditions.
Default settings are underlined.

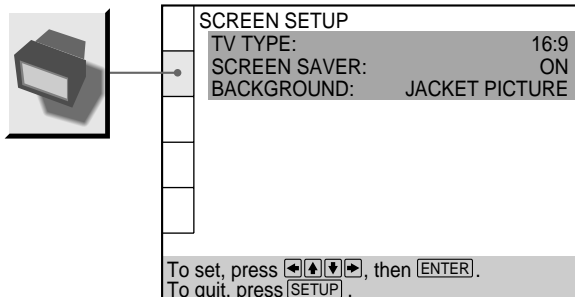

■TV TYPE

Selects the aspect ratio of the TV to be connected.

- 16:9: when you connect a wide-screen TV to the player.
- 4:3 LETTER BOX: when you connect a normal TV to the player. Displays a wide picture with bands displayed on the upper and lower portions of the screen.
- 4:3 PAN SCAN: when you connect a normal TV to the player. Displays the wide picture on the whole screen with a portion automatically cut off.

16:9

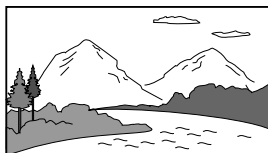

4:3 LETTER BOX



4:3 PAN SCAN

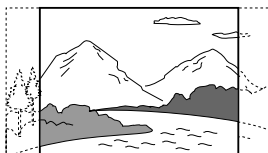

Note

Depending on the DVD, "4:3 LETTER BOX" may be selected automatically instead of "4:3 PAN SCAN" and vice versa.

■SCREEN SAVER

Turns on and off the screen saver. If you turn on the screen saver, the screen saver image appears when you leave the player or the remote in pause or stop mode for 15 minutes or when you play back a CD for more than 15 minutes. The screen saver is useful to prevent your display from becoming damaged.

- ON: turns on the screen saver.
- OFF: turns off the screen saver.

■BACKGROUND

Selects the background color or picture of the TV screen in stop mode or while playing a CD.

- JACKET PICTURE: The jacket picture appears in the background, but only when the jacket picture is already recorded on the disc.
- GRAPHICS: The graphic picture stored in memory in the player beforehand appears in the background.
- BLUE: The background color is blue.
- BLACK: The background color is black.

Note

If a disc which does not contain the jacket picture is played while "BACKGROUND" is set to "JACKET PICTURE," the graphic picture stored in the player will automatically appear in the background.

Custom Settings (CUSTOM SETUP)



Select "CUSTOM SETUP" after pressing SET UP. "CUSTOM SETUP" allows you to set the playback conditions.

Default settings are underlined.

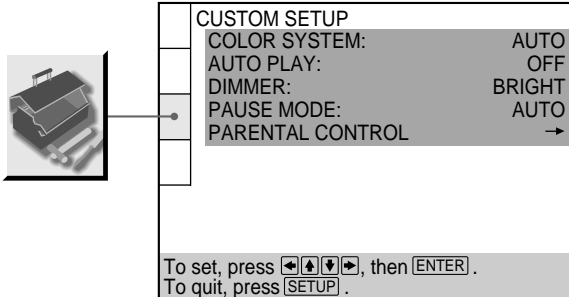

■ COLOR SYSTEM

Selects the color system when you play a VIDEO CD.

- AUTO: outputs the video signal in the system of the VIDEO CD, either PAL or NTSC. If your TV is the DUAL system, select AUTO.
- PAL: changes the video signal of an NTSC VIDEO CD and outputs it in PAL system.
- NTSC: changes the video signal of a PAL VIDEO CD and outputs it in NTSC system.

Notes

- You cannot change the color system of the DVD itself.
- You can change the color system of this unit according to the connected TV. See page 11.

■ AUTO PLAY

Selects the setting of Auto Play when you connect the AC power cord to the AC outlet.

- OFF: does not use "TIMER," "DEMO1" or "DEMO2" to start playing.
- TIMER: starts playing a disc automatically when you connect the AC power cord to the AC outlet. By connecting a timer (not supplied), you can start playing at any time you want.
- DEMO1: starts playing the demonstration 1 automatically.
- DEMO2: starts playing the demonstration 2 automatically.

■ DIMMER

Adjusts the lighting of the front panel display.

- BRIGHT: makes the front panel display bright.
- DARK: makes the front panel display dark.
- OFF: turns off the lighting of the front panel display.
- AUTO: turns on the front panel display for a few seconds when a button on the player or the remote is pressed.

■ PAUSE MODE (DVD only)

Selects the picture in pause mode.

- AUTO: A picture including subjects that move dynamically is output with no jitter. Normally select this position.
- FRAME: A picture including subjects that do not move dynamically is output with high resolution.

■ PARENTAL CONTROL →

Sets a password and playback limitation level when you play DVDs with playback limitation for children.

For details, see "Limiting Playback by Children (Parental Control) ."

Limiting Playback by Children (Parental Control)

Select "CUSTOM SETUP" after pressing SET UP.

Playing some DVDs can be limited depending on the age of users. The "Parental Control" function allows you to set a playback limitation level.

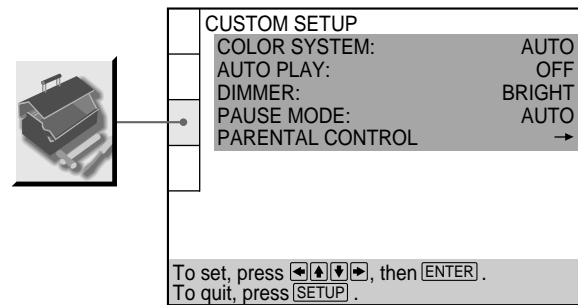

- 1 Select "PARENTAL CONTROL" using ↑/↓, then press ENTER.

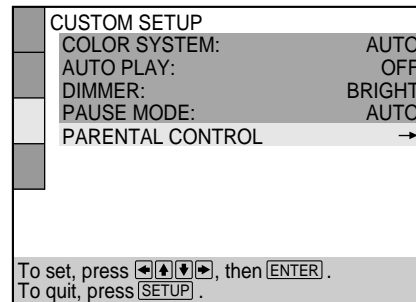

Custom Settings (CUSTOM SETUP)

- When you have not entered a password yet
The display for entering a password appears.

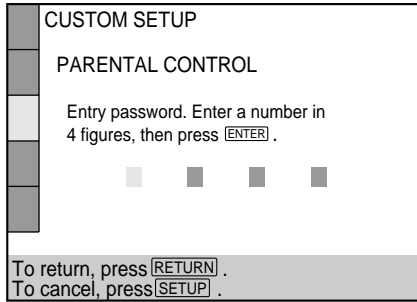

- When you have already entered a password
The display for confirming the password appears. Skip Step 2.

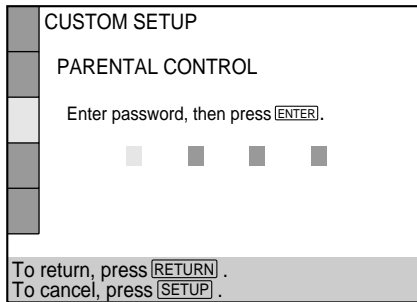

- 2 Enter a password in 4 digits using the number buttons, then press ENTER.
The digits change to asterisks (*), and the display for confirming the password appears.

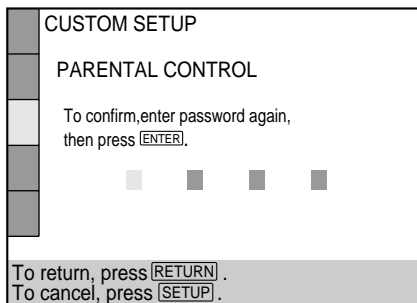

- 3 To confirm your password, enter it using the number buttons, then press ENTER.
The display for setting the playback limitation level and changing the password appears.

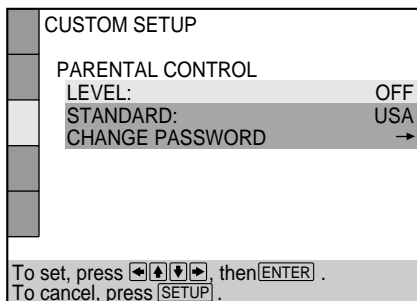

- 4 Select "STANDARD" using ↑/↓, then press →.

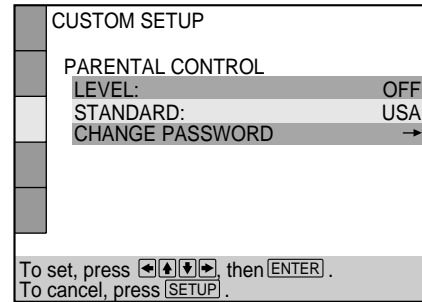

- 5 Select an area as the standard for playback limitation level using ↑/↓, then press →.
When you select "OTHERS→," select and enter the standard code in the table below using number buttons.

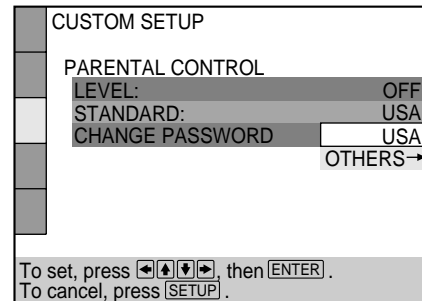

- 6 Select "LEVEL" using ↑/↓, then press →.

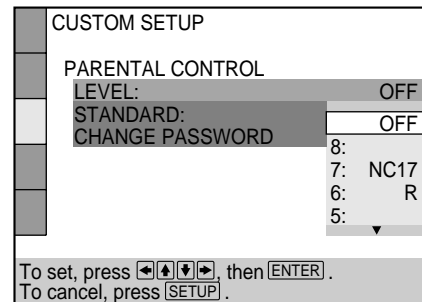

- 7 Select the level you want using ↑/↓, then press ENTER.

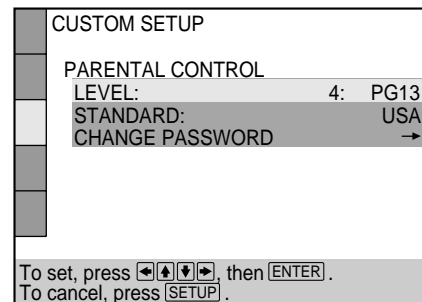

The lower the value is, the more strict the limitation.

To return to the normal screen

Press SET UP.

To turn off the Parental Control function and play the DVD after entering your password

Set “LEVEL” to “OFF” in Step 7, then press \triangleright .

To change the password

1 After Step 3, select “CHANGE PASSWORD” using

\uparrow/\downarrow , then press \rightarrow or ENTER.

The display for changing the password appears.

2 Follow Steps 2 and 3 to enter a new password.

 You can turn off the Parental Control function just after inserting the DVD (Parental Control Temporarily Canceled) When you set a playback limitation level and insert the DVD, the PARENTAL CONTROL display appears. Enter the password to turn off the Parental Control function. When you stop playing the DVD, the level returns to the original level.

 **If you have forgot your password**

Enter the 6 digits number “199703” in Step 2 to clear the current password. To enter a new password, follow the procedure from Step 2 again.

Notes

- When you play DVDs which do not have the Parental Control function, playback cannot be limited on this player.
- When you do not set a password, you cannot change the settings for playback limitation.
- Depending on the DVD, you may be asked to change the parental control level while playing the disc. In this case, enter the password, then change the level.

When you stop playing the DVD, the level returns to the original level.

Standard	Code number
Austria	2046
Belgium	2057
Canada	2079
China	2092
Denmark	2115
Finland	2165
France	2174
Germany	2109
Hong Kong	2219
Indonesia	2238
Italy	2254
Japan	2276
Malaysia	2363
Netherlands	2376
Norway	2379
Philippines	2424
Russian	2489
Singapore	2501
Spain	2149
Sweden	2499
Switzerland	2086
Taiwan	2543
Thailand	2528
United Kingdom	2184

Settings for Sound (AUDIO SETUP)

Select "AUDIO SETUP" after pressing SET UP.
"AUDIO SETUP" allows you to set the sound according to the playback conditions.
Default settings are underlined.

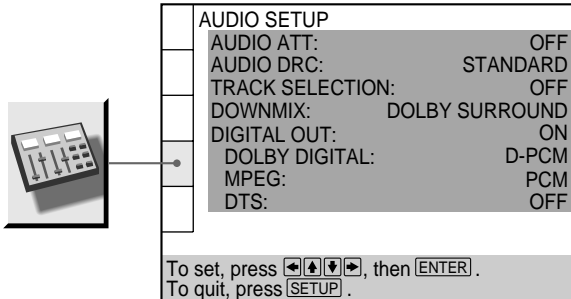

■AUDIO ATT (attenuation)

Selects the setting of the output from the LINE OUT (AUDIO 1, 2) connectors according to the audio equipment to be connected.

- OFF: turns off the audio attenuation.
- ON: reduces the audio output level so that no sound distortion occurs.

Note

The setting does not affect the output from the OPTICAL and COAXIAL connectors.

■AUDIO DRC (Dynamic Range Control)

Makes the sound clear with the volume turned down at night, etc., when you play a DVD. This affects the output from the OPTICAL and COAXIAL connectors only when "PCM" in "DIGITAL OUT" is set to "ON," and it affects the output from the LINE OUT (AUDIO 1, 2) connectors.

- STANDARD: Normally select this position.
- TV MODE: makes the low sound clear even if you turned the volume down, so it is good for playing at night. It is especially recommended when you listen to the sound using the speakers of the TV.
- WIDE RANGE: It gives you the feeling of being at a live performance. When you use high quality speakers, it is more effective.

Notes

- When you play DVDs without the AUDIO DRC function, there may be no effects on the sound.
- When this item is set to "WIDE RANGE," the sound volume may be less than usual.

■TRACK SELECTION

Gives the sound track which contains the highest number of the channels priority when you play a DVD on which multiple audio formats are recorded. If multiple audio channels are recorded in PCM, DTS, MPEG AUDIO or Dolby Digital format, the higher-numbered channel audio recorded in PCM, DTS, MPEG AUDIO or Dolby Digital format is played.

- OFF: No priority given.
- AUTO: Priority given.

Notes

- When you set this item to "AUTO," the language may change depending on the "AUDIO" settings in "LANGUAGE SETUP." The "TRACK SELECTION" setting has higher priority than that of "AUDIO" settings in "LANGUAGE SETUP" (page 45).
- If you set "DTS" in "AUDIO SETUP" to "OFF," the DTS sound track is not played even if you set this item to "AUTO" and the highest-numbered channel audio is recorded in DTS format.
- If PCM, DTS, MPEG AUDIO and Dolby Digital sound tracks have the same number of the highest channels, the player selects PCM, DTS, Dolby Digital and MPEG AUDIO sound tracks, in this order.
- Depending on the DVD, the audio with priority may be predetermined. In this case, you cannot give priority to the DTS, MPEG AUDIO or Dolby Digital format by selecting "AUTO."

■DOWNMIX*

Switches the mixing down methods when you play a DVD on which 3 or more channels in Dolby Digital format are recorded.

- DOLBY SURROUND: when the player is connected to an audio component that conforms to Dolby Surround (Pro Logic).
- NORMAL: when the player is connected to a normal audio component.

* The setting affects the following connectors:

- LINE OUT (AUDIO 1, 2) connectors
- OPTICAL and COAXIAL connectors

■ DIGITAL OUT

Selects output signals via the OPTICAL and COAXIAL connectors.

- **ON:** Normally select this position. When you select “ON,” set “DOLBY DIGITAL,” “MPEG” and “DTS.” For details on setting them, see “Setting for the signal to the digital output.”
- **OFF:** when the player does not output the sound signals via the OPTICAL and COAXIAL connectors, if you select this position, the influence of the digital circuit upon the analog one is minimum.





Notes

- When you play the sound tracks with 96 kHz sampling frequency, the output signals from the OPTICAL and COAXIAL connectors are converted to 48 kHz (sampling frequency). When the signals are output from LINE OUT (AUDIO 1, 2) connectors, sampling frequency stays at 96 kHz and the output signals are converted to analog signals.
- When you select “OFF,” you cannot set “DOLBY DIGITAL,” “MPEG” and “DTS.”

Setting for the signal to the digital output

When you select “ON,” set “DOLBY DIGITAL,” “MPEG” and “DTS.”

Switches the methods of outputting audio signals when you connect a digital component such as a receiver (amplifier) having a digital connector, an audio component having a built-in DTS decoder, a DAT or MD via the OPTICAL or COAXIAL connector using an optical or coaxial digital connecting cord. For details on the connection, see pages 13 and 15.

AUDIO SETUP	
AUDIO ATT:	OFF
AUDIO DRC:	STANDARD
TRACK SELECTION:	OFF
DOWNMIX:	DOLBY SURROUND
DIGITAL OUT:	ON
DOLBY DIGITAL:	D-PCM
MPEG:	PCM
DTS:	OFF
To set, press     , then [ENTER].	
To quit, press [SETUP].	

■ DOLBY DIGITAL

Selects output Dolby Digital signals via the OPTICAL and COAXIAL connectors. You cannot select this item when you set “DIGITAL OUT” to “OFF.”

- **D-PCM (Downmix PCM):** when you play the Dolby Digital sound tracks, the output audio signals are mixed down to 2 channels. With the settings of the item “DOWN MIX” in “AUDIO SETUP,” you can select whether the signals conform to Dolby Surround (Pro Logic) or not.
- **DOLBY DIGITAL:** when the player is connected to an audio component with a built-in Dolby Digital decoder.

Note

If the player is connected to an audio component lacking a built-in Dolby Digital decoder, do not set “DOLBY DIGITAL” in “AUDIO SETUP” to “DOLBY DIGITAL.” Otherwise, when you play the Dolby Digital sound track, a loud noise or no sound will come out from the speakers, affecting your ears or causing the speakers to be damaged.

Note

When “DOLBY DIGITAL” is selected, you cannot select VES in the Control Menu display.

■ MPEG

Selects output MPEG AUDIO signals via the OPTICAL and COAXIAL connectors. You cannot select this item when you set “DIGITAL OUT” to “OFF.”

- **PCM:** when the player is connected to an audio component lacking a built-in MPEG decoder. If you play MPEG AUDIO sound tracks, the player outputs stereo signals taken from MPEG AUDIO signals via the OPTICAL and COAXIAL connectors.
- **MPEG:** when the player is connected to an audio component having a built-in MPEG decoder.

Note

If the player is connected to an audio component lacking a built-in MPEG decoder, do not set “MPEG” in “AUDIO SETUP” to “MPEG.” Otherwise, when you play the MPEG AUDIO sound track, a loud noise will come out from the speakers, affecting your ears or causing the speakers to be damaged.

Note

The player outputs the MPEG analog audio sound only from the front speakers when you set “DIGITAL OUT” in “AUDIO SETUP” to “ON” and then set “MPEG” to “MPEG.”

Settings for Sound (AUDIO SETUP)

■ DTS

Selects output DTS signals via the OPTICAL and COAXIAL connectors. You cannot select this item when you set "DIGITAL OUT" to "OFF."

- **OFF:** when the player is connected to an audio component lacking a built-in DTS decoder.
- **ON:** when the player is connected to an audio component having a built-in DTS decoder.

Note

Select the setting correctly. Otherwise, no sound or strange sound will come out from the speakers, affecting your ears or causing the speakers to be damaged.

- Do not play the DTS sound tracks without connecting the player to an audio component having a built-in DTS decoder. You cannot hear the DTS sound unless you connect the player to an audio component having a built-in DTS decoder.
- When you play the DTS sound track on a CD, a loud noise may come out from the LINE OUT (AUDIO 1, 2) and PHONES connectors, affecting your ears or causing the speakers or headphones to be damaged.
- When you play the DTS sound track on a DVD, no sounds will come out from the LINE OUT (AUDIO 1, 2) and PHONES connectors.

Notes on playing the DTS sound tracks on a CD

- Do not play the DTS sound tracks without connecting the player to an audio component having a built-in DTS decoder. The player outputs the DTS signal via the OPTICAL and COAXIAL connectors even if "DTS" in "AUDIO SETUP" is set to "OFF" in the setup display, affecting your ears or causing the speakers to be damaged.
- The DTS indicator on the front panel does not light up even if the player outputs DTS signal via the OPTICAL and COAXIAL connectors.
- Set the sounds to "STEREO" when you play the DTS sound tracks on a CD. (See "Changing the Sounds" on page 32.) If you set the sounds to "1/L" or "2/R," no sounds will come out from the OPTICAL and COAXIAL connectors.

Notes on playing the DTS sound tracks on a DVD

- No sounds will come out from the LINE OUT (AUDIO 1, 2) and PHONES connectors.
- If the player is connected to an audio component lacking a built-in DTS decoder, do not set "DTS" in "DIGITAL OUT" to "ON" in the setup display. Otherwise, when you play the DTS sound track, a loud noise will come out from the speakers, affecting your ears or causing the speakers to be damaged.
- When you set "DTS" in "AUDIO SETUP" to "OFF," no sound will come out from the OPTICAL and COAXIAL connectors even if you play DTS sound tracks on DVDs.
- The DTS indicator on the front panel display lights up when you play DTS sound tracks.

Speaker Set Up

Select "SPEAKER SETUP" after pressing SET UP. When you have connected a subwoofer, specify the size of the front speakers you have connected to change the frequency range output from the subwoofer so that you can obtain the best possible surround sound. Even if you change the setting of "SUBWOOFER" or "FRONT SPEAKER SIZE," the sound output from the front speakers do not change. For the speaker hookups, see pages 12 and 14.

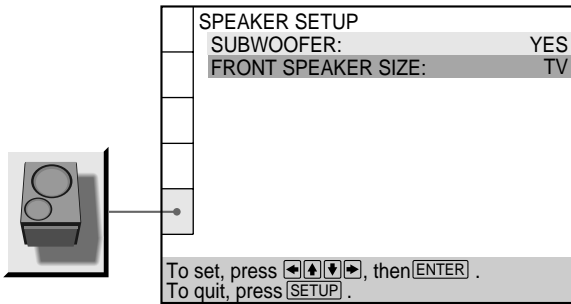

■ SUBWOOFER

Selects whether a subwoofer is connected to the player or not.

- **NONE:** When a subwoofer is not connected to the player.
- **YES:** When a subwoofer is connected to the player, you can select the output level from the subwoofer in "FRONT SPEAKER SIZE" according to the front speakers you are using.

■ FRONT SPEAKER SIZE

Selects the size of the connected front speakers. The frequency range output from the subwoofer varies according to the size of the front speakers.

You cannot select this item when you set "SUBWOOFER" to "NONE."

- **LARGE:** If you connect large speakers that will effectively reproduce bass frequencies, and play a DVD recorded in 5.1 channel including LFE signal, select this. If you feel a lack of bass frequencies from the front speakers when you select this, select "MIDDLE."

Note

If LFE signal is not recorded in the disc, no sound will be output from the subwoofer even if you select "LARGE."

- **MIDDLE:** If you connect large speakers that will effectively reproduce bass frequencies and play a source on which LFE signal is not recorded, select this to output the bass frequencies in the front channel also from the subwoofer. If you feel a lack of bass frequencies from the front speakers when you select this, select "SMALL."
- **SMALL:** If the sound is distorted, or you feel a lack of surround effects, select this to output the bass frequencies, which the front speakers cannot output, from the subwoofer. If you feel a lack of bass frequencies from the front speakers when you select this, select "TV."
- **TV:** If you do not connect front speakers, select this to output the bass frequencies from the subwoofer. If you connect small speakers, select this.

The subwoofer outputs LFE signal and the frequency range shown below depending on the FRONT SPEAKER SIZE setting. The LFE signal is output only when the disc contains the LFE signal.

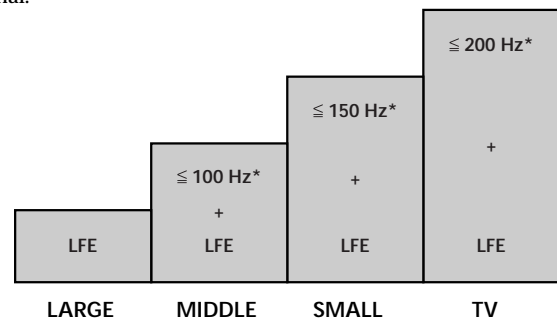

* Audio signal besides LFE

Controlling the TV or the AV Receiver (Amplifier) with the Supplied Remote

If you adjust the remote signal, you can control your TV with the supplied remote. Default setting is to control Sony TVs with the  mark.

When you connect the player to a Sony AV receiver (amplifier), you can also set the input of the receiver (amplifier) to this player with the supplied remote .

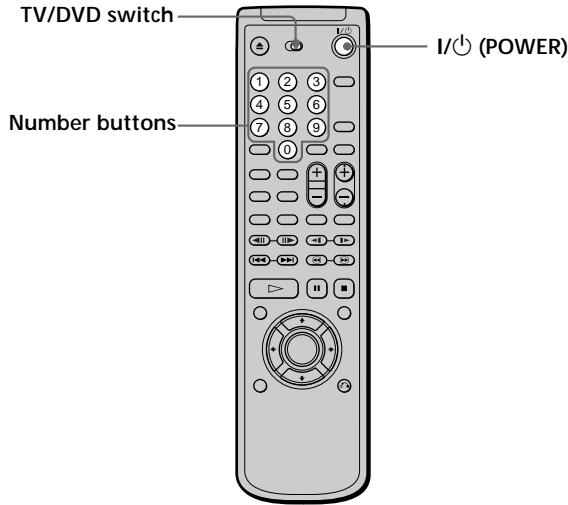

Manufacturer	Code number
Sony (default)	01
Gold Star	03, 04
Philips	06, 08
Miver	09
Blaupunkt	10, 21
Grundig	11
Saba	12, 13
Panasonic	17, 49
Samsung	23
Hitachi	24
Sanyo	25
Pioneer	26
Mitsubishi	27, 28, 50

Manufacturer	Code number
Sharp	29
Aiwa	32
JVC	33
Toshiba	38
Siemens	39
Thomson	43
Loewe	45
Orion	47, 48
Ferguson	52
NEC	66
TEAC	67
Akai	68
Nokia	69

Controlling TVs with the remote

- 1 Slide the TV/DVD switch to TV.
- 2 Hold down I/⏻ (POWER), and enter your TV's manufacturer's code (see the table) using the number buttons. Then release I/⏻ (POWER).

Code numbers of controllable TVs

If more than one code number is listed, try entering them one at a time until you find the one that works with your TV.

Notes

- If you enter a new code number, the code number previously entered will be erased.
- When you replace the batteries of the remote, the code number may reset to 01 (Sony). Reset the appropriate code number.

When you set the TV/DVD switch to TV, you can control your TV using the keys below.

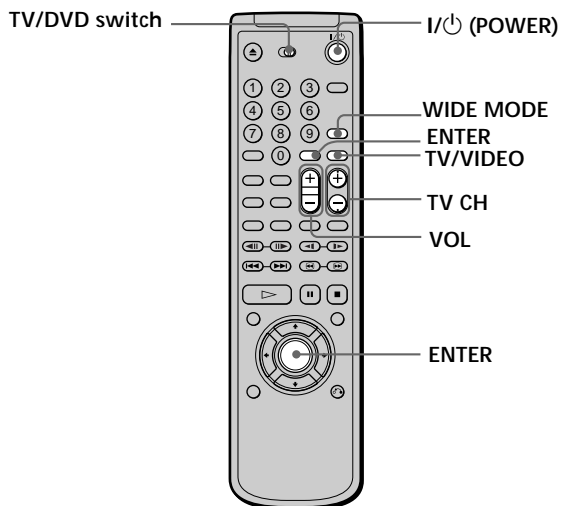

By pressing	You can
I/⏻ (POWER)	Turn the TV on or off
TV/VIDEO	Select the input source for the TV between the TV and VCR
VOL	Adjust the volume of the TV
TV CH	Select the channel of the TV
WIDE MODE	Switch the wide picture on or off

Note

Depending on the TV, you may not be able to control your TV or to use some of the buttons above.

Controlling an AV receiver (amplifier) with the remote

- 1 Slide the TV/DVD switch to DVD.
- 2 Hold down I/⏻ (POWER), and enter your AV receiver's manufacturer's code (see the table below) using the number buttons. Then release I/⏻ (POWER).

Manufacturer	Code number
Sony	91, 88, 89
Denon	84, 85, 86
Kenwood	92, 93
Onkyo	81, 82, 83
Pioneer	99
Sunsui	87
Technics	97, 98
Yamaha	94, 95, 96
Sony TVs	90 (default)*

* By setting the code number 90, you can adjust the volume of the TV even if the TV/DVD switch is on the DVD side, if you do not control an AV receiver (amplifier) with the remote.

Code numbers of controllable receivers (amplifiers)

If more than one code number is listed, try entering them one at a time until you find the one that works with your receiver (amplifier).

You can also change the sound volume of the AV receiver (amplifier) using VOL.

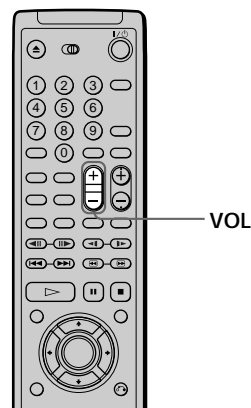

Note

Depending on the AV receiver (amplifier), you may not be able to control your AV receiver (amplifier).

Additional Information

Troubleshooting

If you experience any of the following difficulties while using the player, use this troubleshooting guide to help you remedy the problem. Should any problem persist, consult your nearest Sony dealer.

Power

The power is not turned on.

- ➔ If the indicator above the I / ⏻ (POWER) button is not lit, check that the AC power cord is connected securely.

Picture

There is no picture.

- ➔ Check that the player is connected securely.
- ➔ The video connecting cord is damaged. Replace it with a new one.
- ➔ Make sure you connect the player to the video input connector on the TV (page 10).
- ➔ Make sure you turn on the TV.
- ➔ Make sure you select the video input on the TV so that you can view the pictures from the player.

The picture noise appears.

- ➔ Clean the disc.
- ➔ If video from your DVD player has to go through your VCR to get to your TV, the copy-protection applied to some DVD programs could affect picture quality. If you still experience problems after checking your connections, please try connecting your DVD player directly to your TV's S video-input, if your TV is equipped with this input (page 11).
- ➔ If the color system of your DVD player does not match with that of your TV, change the color system of the player. For details, see page 11. (You cannot change the color system of the DVD disc itself.)

The aspect ratio of the screen cannot be changed even though you set "TV TYPE" in "SCREEN SETUP" in the setup display when you play a wide picture.

- ➔ The aspect ratio is fixed on your DVD.
- ➔ If you connect the player with the S video cable, connect directly to the TV. Otherwise, you may not change the aspect ratio.
- ➔ Depending on the TV, you may not change the aspect ratio.

The numbers or letters of 5 characters are displayed on the front panel display.

- ➔ Self-diagnosis function was activated. See the table in page 59 and treat the player appropriately.

Sound

There is no sound.

- ➔ Check that the player is connected securely.
- ➔ The audio connecting cord is damaged. Replace it with a new one.
- ➔ Make sure you connect the player to the audio input connectors on the receiver (amplifier) (page 12).
- ➔ Make sure you turn on the TV and the receiver (amplifier).
- ➔ Make sure you select the appropriate position on the receiver (amplifier) so that you can listen to the sound from the player.
- ➔ The player is in pause mode or in Slow-motion Play mode. Press \square to return to normal play mode.
- ➔ Fast forward (FF1 $\blacktriangleright\blacktriangleright$ or FF2 $\blacktriangleright\blacktriangleright$) or fast reverse (FR1 $\blacktriangleleft\blacktriangleleft$ or FR2 $\blacktriangleleft\blacktriangleleft$) is performed. Press \square to return to normal play mode.
- ➔ Check the speaker connections and setting (pages 14, 53). Refer to the operating manual of your receiver (amplifier).
- ➔ When you play the Dolby Digital/MPEG AUDIO sound tracks and attempt to output from the OPTICAL and COAXIAL connectors, set "DIGITAL OUT" to "ON" in the setup display. Otherwise no sound will come out from the OPTICAL and COAXIAL connectors (page 51).
- ➔ When you play the DTS sound tracks, no sound will come out from the LINE OUT (AUDIO 1, 2) and PHONES connectors (page 52).

Sound noise is heard.

- ➔ Clean the disc.
- ➔ When you play the DTS sound tracks on a CD, sound noise will come out from the LINE OUT (AUDIO 1, 2) and PHONES connectors (page 52).

Sound distortion occurs.

- ➔ In the setup display, set "AUDIO ATT" in "AUDIO SETUP" to "ON" (page 50).

The sound loses stereo effect when you play a VIDEO CD or a CD.

- ➔ Set "AUDIO" to "STEREO" in the Control Menu display (page 32).
- ➔ Make sure you connect the player appropriately (pages 10, 12, 14, 15).

The surround effect is difficult to hear when you are playing a Dolby Digital sound track.

- ➔ Check the speaker connections and setting (pages 14, 53). Refer to the operating manual of your receiver (amplifier).
- ➔ Depending on the DVD, the output signal may not be the entire 5.1 channel but monaural or stereo even if the sound track is recorded in Dolby Digital format.

The sound comes from the center speaker only.

- ➔ Depending on the disc, the sound may come from the center speaker only.

The sound comes from the front speaker only.

- ➔ You set "VES" to "VES A" or "VES B" in the Control Menu display when you have connected the rear speakers (page 35). Select the other item.

Operation

The remote does not function.

- ➔ Remove any obstacles between the remote and the player.
- ➔ Use the remote near the player.
- ➔ Point the remote at the remote sensor \blacksquare on the player.
- ➔ Replace all the batteries in the remote with new ones if they are weak.

The disc does not play.

- ➔ There is no disc inside ("Insert disc." appears on the TV screen). Insert a disc.
- ➔ Insert the disc correctly with the playback side facing down.
- ➔ Clean the disc.
- ➔ "ERROR" appears on the front panel display if a disc such as CD-ROMs (page 5) which the player cannot play was inserted. Insert a DVD, a VIDEO CD, or a CD.
- ➔ Check the region code of the DVD (page 4).
- ➔ Moisture has condensed inside the player. Remove the disc and leave the player turned on for about half an hour (page 6).
- ➔ "ERROR" appears on the front panel display if a disc was placed upside down. Insert the disc with playing side facing down.

Troubleshooting

The player does not play from the beginning when playing a disc.

- ➔ Repeat Play, Shuffle Play or Program Play has been selected. Press CLEAR (pages 37 to 39).
- ➔ Resume Play has been selected. Press ■ on the front panel or on the remote before you start playing (page 21).
- ➔ A title menu or a DVD menu automatically appears on the TV screen when you play your DVD, or a setup display automatically appears on the TV screen when you play your VIDEO CD with PBC functions.

The player starts playing the DVD automatically.

- ➔ The DVD features the auto playback function.

Playback stops automatically.

- ➔ Depending on the disc, the auto pause signal is recorded. While playing such a disc, the player stops playback at the signal.

Stopping playback, Search, Slow-motion Play, Repeat Play, Shuffle Play or Program Play, etc., cannot be done.

- ➔ Depending on the disc, you may not do some of the operations above.

Messages do not appear on the TV screen in the language you want.

- ➔ In the setup display, select the language for the on-screen display in "OSD" under "LANGUAGE SETUP" (page 45).

The language for the sound cannot be changed when you play a DVD.

- ➔ Multilingual sound is not recorded on the DVD.
- ➔ Changing the language for the sound is prohibited on the DVD.

The language for the subtitles cannot be changed when you play a DVD.

- ➔ Multilingual subtitles are not recorded on the DVD.
- ➔ Changing the language for the subtitles is prohibited on the DVD.

The subtitles cannot be turned off when you play a DVD.

- ➔ Depending on the DVD, you may not be able to turn the subtitles off.

The angles cannot be changed when you play a DVD.

- ➔ Multi-angles are not recorded on the DVD.
- ➔ Change the angles when "ANGLE" appears on the front panel display (page 34).
- ➔ Changing the angles is prohibited on the DVD.

The player does not operate properly.

- ➔ Static electricity, etc., may affect the player's operation. Disconnect the AC power cord once, then connect it again.

Nothing is displayed on the front panel display.

- ➔ In the set up display, "DIMMER" in "CUSTOM SETUP" is set to "OFF" or "AUTO." If you want to keep the display on, set "DIMMER" to "BRIGHT" or "DARK" (page 47). "AUTO" turns on the display only when you operate the player.

The player does not eject the disc and displays "LOCKED" on the front panel display.

- ➔ Contact your Sony dealer or local authorized Sony service facility.

Self-diagnosis Function

When the self-diagnosis function works to prevent the player from malfunctioning, a five-character service number (combination of a letter and digits) flashes on the front panel display. In this case, check the following table.

First three characters	Cause and/or Corrective Action
C13	<ul style="list-style-type: none">• The disc is dirty. ➔ Clean the disc with a cleaning cloth (page 7).
C31	<ul style="list-style-type: none">• The disc is not inserted correctly. ➔ Insert the disc correctly.
Exx (xx is any number)	<ul style="list-style-type: none">• To prevent the player from malfunctioning, the self-diagnosis function has worked. ➔ When you contact your Sony dealer or local authorized Sony service facility, give the 5-character service number. (example: E:61:10)

Specifications

CD/DVD player

Laser Semiconductor laser
 Signal format system NTSC/PAL (See page 11 to switch.)

Audio characteristics

Frequency response
 DVD (PCM 96 kHz): 2 Hz to 44 kHz (±1 dB)*
 DVD (PCM 48 kHz): 2 Hz to 22 kHz (±0.5 dB)
 CD: 2 Hz to 20 kHz (±0.5 dB)

Signal-to-noise ratio
 More than 110 dB (LINE OUT (AUDIO 1, 2) connectors only)

Harmonic distortion
 Less than 0.0025%

Dynamic range
 More than 100 dB (DVD)
 More than 97 dB (CD)

Wow and flutter
 Less than detected value (±0.001% W PEAK)

Outputs and inputs

	Jack type	Output level	Load impedance
LINE OUT (AUDIO 1, 2)	Phono jacks	2 Vrms (at 50 kilohms)	Over 10 kilohms
OPTICAL	Optical output connector	-18 dBm	Wave length: 660 nm
COAXIAL	Phono jack	0.5 Vp-p	75 ohms terminated
LINE OUT (VIDEO 1, 2)	Phono jacks	1.0 Vp-p	75 ohms, sync negative
LINE OUT (S-VIDEO 1, 2)	4-pin mini DIN	Y: 1.0 Vp-p C: 0.3 Vp-p (PAL) 0.286 Vp-p (NTSC)	75 ohms, sync negative 75 ohms terminated
LINE OUT (WOOFER OUT)	Phono jack	2 Vrms (at 50 kilohms)	Over 10 kilohms
PHONES	Phone jack	12 mW	32 ohms

General

Power requirements
 DC 10.5 V

Power consumption
 13 W

Dimensions (approx.)
 215 × 60 × 314 mm (w/h/d) incl. projecting parts

Mass (approx.)
 2.1 kg

Operating temperature
 5 °C to 35 °C (41 °F to 95 °F)

Operating humidity
 25 % to 80 %

AC power adaptor

Power requirements
 100 to 110 V AC, 50/60 Hz

Output voltage
 DC 10.5 V, 1.3 A in operating mode

Dimensions (approx.)
 125 × 39 × 62 mm (w/h/d) excl. projecting parts

Mass (approx.)
 235 g

Operating temperature
 5 °C to 35 °C

Storage temperature
 -20 °C to +60 °C

Supplied accessories

See page 8.

* The signals from LINE OUT (AUDIO 1, 2) connectors are measured. When you play the PCM sound tracks with 96 kHz sampling frequency, the output signals from the OPTICAL and COAXIAL connectors are converted to 48 kHz (sampling frequency).

Design and specifications are subject to change without notice.

Glossary

Bit rate (page 41)

Value indicating the amount of video data compressed in a DVD per second. The unit is Mbps (Mega bit per second). 1 Mbps indicates that the data per second is 1,000,000 bits. The higher the bit rate is, the larger the amount of data. However, this does not always mean that you can get higher quality pictures.

Chapter (page 5)

Sections of a picture or a music piece on a DVD that are smaller than titles. A title is composed of several chapters. Each chapter is assigned a chapter number enabling you to locate the chapter you want.

Digital Cinema Sound (DCS) (page 35)

The general name of technology that Sony developed to enjoy the surround sound in a home. To enjoy the surround sound of a movie theater in the comfort of your own home, it simulates the sound not in a concert hall as usual but in a movie editing studio. This player adopts VES (Virtual Enhanced Surround) system from various DCS programs. The VES system can create the sound image of virtual rear speakers from the sound of the front speakers (L, R) without using actual rear speakers.

Dolby Digital (pages 15, 32)

Digital audio compression technology that the Dolby Laboratories Corporation developed. This technology conforms to 5.1-channel surround sound. The rear channel is stereo and there is discrete subwoofer channel in this format. Dolby Digital provides the same 5.1 discrete channels of high quality digital audio found in Dolby Digital Cinema audio systems. The good channel separation is realized because the all channel data is recorded discrete and processed in digital.

Dolby Pro Logic (page 51)

Audio signal processing technology that Dolby Laboratories Corporation developed for surround sound. When the input signal has the surround component, the Pro Logic process outputs the front, center and rear signals. The rear channel is monaural.

DTS (page 52)

Digital audio compression technology that the Digital Theater Systems, Inc. developed. This technology conforms to 5.1-channel surround. The rear channel is stereo and there is discrete subwoofer channel in this format. DTS provides the same 5.1 discrete channels of high quality digital audio. The good channel separation is realized because the all channel data is recorded discrete and processed in digital.

DVD (page 4)

A disc that contains up to 8 hours of moving pictures even though its diameter is the same as a CD.

The data capacity of a single-layer and single-sided DVD, at 4.7 GB (Giga Byte), is 7 times that of a CD.

Furthermore, the data capacity of a dual-layer and single-sided DVD is 8.5 GB, a single-layer and double-sided DVD 9.4 GB, and a dual-layer and double-sided DVD 17 GB.

The picture data uses the MPEG 2 format, one of the worldwide standards of digital compression technology. The picture data is compressed to about 1/40 of its original size. The DVD also uses the variable rate coding technology that changes the data to be allocated according to the status of the picture.

The audio data is recorded in Dolby Digital as well as in PCM, allowing you to enjoy more real audio presence.

Furthermore, various advanced functions such as the multi-angle, multilingual, and Parental Control functions are provided with the DVD.

MPEG AUDIO (pages 35, 51)

International standard coding system to compress audio digital signals authorized by ISO/IEC. MPEG 1 conforms to up to 2-channel stereo. MPEG 2 used on DVDs conforms to up to 7.1-channel surround.

Multi-angle function (page 34)

Various angles, or viewpoints of the video camera, for a scene are recorded on some DVDs.

Multilingual function (pages 17, 33, 45)

Several languages for the sound or subtitles in a picture are recorded on some DVDs.

Parental Control (page 47)

A function of the DVD to limit playback of the disc by the age of the users according to the limitation level in each country. The limitation varies from disc to disc; when it is activated, playback is completely prohibited, violent scenes are skipped or replaced with other scenes and so on.

Playback Control (PBC) (page 23)

Signals encoded on VIDEO CDs (Version 2.0) to control playback.

By using menu screens recorded on VIDEO CDs with PBC functions, you can enjoy playing simple interactive programs, programs with search functions, and so on.

Glossary

Title (page 5)

The longest sections of a picture or a music piece on a DVD; a movie, etc., for a picture piece on video software; or an album, etc., for a music piece on an audio software. Each title is assigned a title number enabling you to locate the title you want.

Track (page 5)

Sections of a picture or a music piece on a CD or VIDEO CD. Each track is assigned a track number enabling you to locate the track you want.

VIDEO CD (page 4)

A compact disc that contains moving pictures.

The picture data uses the MPEG 1 format, one of the worldwide standards of digital compression technology.

The picture data is compressed to about 1/140 of its original size. Consequently, a 12 cm VIDEO CD can contain up to 74 minutes of moving pictures.

VIDEO CDs also contain compact audio data. Sounds outside the range of human hearing are compressed while the sounds we can hear are not compressed. VIDEO CDs can hold 6 times the audio information of conventional audio CDs.

There are 2 versions of VIDEO CDs.

- Version 1.1: You can play only moving pictures and sounds.
- Version 2.0: You can play high-resolution still pictures and enjoy PBC functions.

This player conforms to both versions.

Language Code List

For details, see pages 33 and 45.

The language spellings conform to the ISO 639: 1988 (E/F) standard.

Code	Language	Code	Language	Code	Language	Code	Language
1027	Afar	1186	Scots Gaelic	1350	Malayalam	1513	Siswati
1028	Abkhazian	1194	Galician	1352	Mongolian	1514	Sesotho
1032	Afrikaans	1196	Guarani	1353	Moldavian	1515	Sundanese
1039	Amharic	1203	Gujarati	1356	Marathi	1516	Swedish
1044	Arabic	1209	Hausa	1357	Malay	1517	Swahili
1045	Assamese	1217	Hindi	1358	Maltese	1521	Tamil
1051	Aymara	1226	Croatian	1363	Burmese	1525	Telugu
1052	Azerbaijani	1229	Hungarian	1365	Nauru	1527	Tajik
1053	Bashkir	1233	Armenian	1369	Nepali	1528	Thai
1057	Byelorussian	1235	Interlingua	1376	Dutch	1529	Tigrinya
1059	Bulgarian	1239	Interlingue	1379	Norwegian	1531	Turkmen
1060	Bihari	1245	Inupiak	1393	Occitan	1532	Tagalog
1061	Bislama	1248	Indonesian	1403	(Afan) Oromo	1534	Setswana
1066	Bengali; Bangla	1253	Icelandic	1408	Oriya	1535	Tonga
1067	Tibetan	1254	Italian	1417	Punjabi	1538	Turkish
1070	Breton	1257	Hebrew	1428	Polish	1539	Tsonga
1079	Catalan	1261	Japanese	1435	Pashto; Pushto	1540	Tatar
1093	Corsican	1269	Yiddish	1436	Portuguese	1543	Twi
1097	Czech	1283	Javanese	1463	Quechua	1557	Ukrainian
1103	Welsh	1287	Georgian	1481	Rhaeto-Romance	1564	Urdu
1105	Danish	1297	Kazakh	1482	Kirundi	1572	Uzbek
1109	German	1298	Greenlandic	1483	Romanian	1581	Vietnamese
1130	Bhutani	1299	Cambodian	1489	Russian	1587	Volapük
1142	Greek	1300	Kannada	1491	Kinyarwanda	1613	Wolof
1144	English	1301	Korean	1495	Sanskrit	1632	Xhosa
1145	Esperanto	1305	Kashmiri	1498	Sindhi	1665	Yoruba
1149	Spanish	1307	Kurdish	1501	Sangho	1684	Chinese
1150	Estonian	1311	Kirghiz	1502	Serbo-Croatian	1697	Zulu
1151	Basque	1313	Latin	1503	Singhalese	1703	Not specified
1157	Persian	1326	Lingala	1505	Slovak		
1165	Finnish	1327	Laothian	1506	Slovenian		
1166	Fiji	1332	Lithuanian	1507	Samoan		
1171	Faroese	1334	Latvian; Lettish	1508	Shona		
1174	French	1345	Malagasy	1509	Somali		
1181	Frisian	1347	Maori	1511	Albanian		
1183	Irish	1349	Macedonian	1512	Serbian		

Index to Parts and Controls

Refer to the pages indicated in parentheses for details.

Front Panel

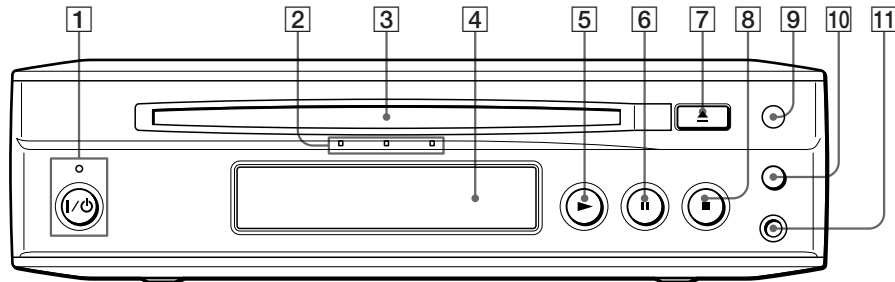

- 1** I/O (POWER) button and indicator (18)
Turns on and off the power of the player.
- 2** Disc type indicator (18)
Lights up when the corresponding disc was inserted.
- 3** Disc slot (18)
Insert a disc.
- 4** Front Panel Display (24)
Indicates the playing time, etc.
- 5** ▷PLAY button and indicator (18)
Plays a disc.
- 6** ■■PAUSE button and indicator (19)
Pauses playing a disc.
- 7** ≡EJECT button (19)
Ejects the disc.
- 8** ■STOP button (19, 21)
Stops playing a disc.
- 9** □ (remote sensor) (8)
Accepts the remote control signals.
- 10** PHONES LEVEL control (18)
Press and adjust the headphone volume. After adjusting, press it again.
- 11** PHONES connector (18)
Connect the headphones to this connector.

Rear Panel

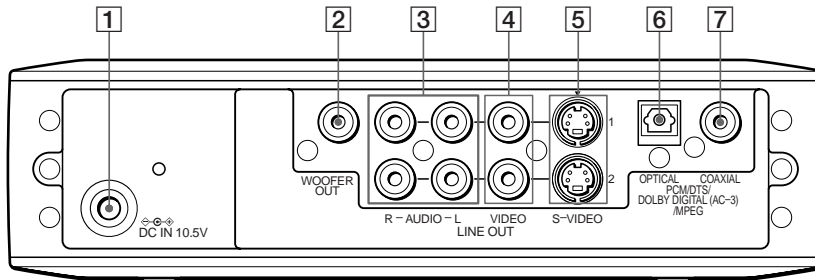

- 1** DC IN 10.5 V jack (10, 12, 14, 16)
Connects the supplied AC power adaptor.
- 2** WOOFER OUT connector (14)
Connects to a subwoofer (not supplied).
- 3** LINE OUT (AUDIO 1, 2) connectors (10, 12, 14)
Connect to the audio input connector on the TV or receiver (amplifier).
- 4** LINE OUT (VIDEO 1, 2) connectors (10)
Connect to the video input connector on the TV or monitor.
- 5** LINE OUT (S-VIDEO 1, 2) connectors (10, 12, 14)
Connect to the S video input connector on the TV or monitor.
- 6** OPTICAL connector (13, 16)
Connects to an audio component using the optical digital connecting cord.
- 7** COAXIAL connector (13, 16)
Connects to an audio component using the coaxial digital connecting cord.

Remote

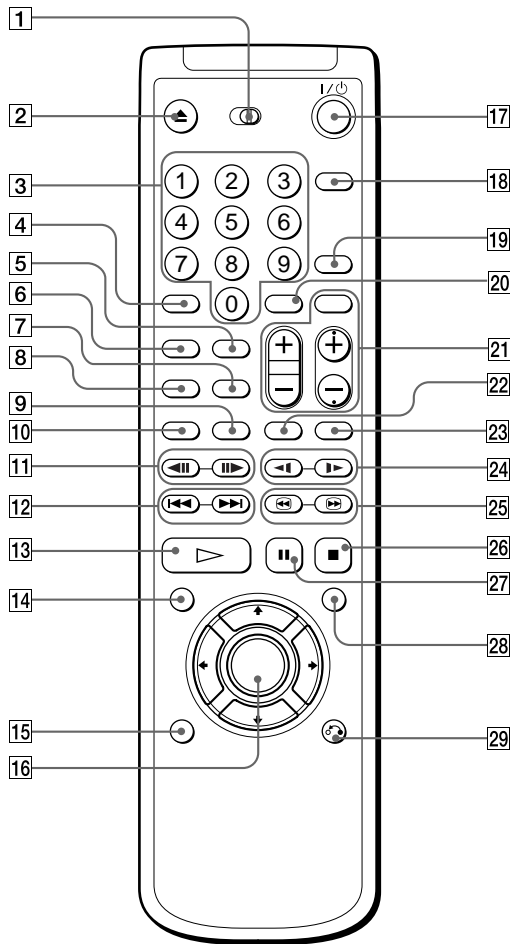

- 1 TV/DVD switch (54)**
Selects to control the player, the TV or the receiver (amplifier) with the remote.
- 2 ▲ (eject) button (19)**
Ejects the disc.
- 3 Number buttons**
Select the items or settings.
- 4 CLEAR button (37, 38, 39, 40)**
Press to return to the Continuous play, etc.
- 5 REPEAT button (39)**
Displays the "REPEAT" display on the TV screen.
- 6 SHUFFLE button (38)**
Displays the "SHUFFLE" display on the TV screen.
- 7 A↔B button (40)**
Displays the "A↔B REPEAT" display on the TV screen.
- 8 PROGRAM button (37)**
Displays the "PROGRAM" display on the TV screen.

- 9 ANGLE button (34)**
Changes the angles when playing a DVD.
- 10 AUDIO button (32)**
Changes the sound while playing a DVD or VIDEO CD.
- 11 ◀▶STEP buttons (20)**
Play a disc frame by frame.
- 12 ◀◀/▶▶PREV/NEXT buttons (19)**
Press to go to the next chapter or track or to go back to the previous chapter or track.
- 13 ▷PLAY/SELECT button (19)**
Plays a disc.
- 14 TITLE button (22)**
Displays the title menu on the TV screen.
- 15 DISPLAY button (26)**
Displays the Control Menu display on the TV screen to set or adjust the items.
- 16 ◀/↑/↓/▶/ENTER button**
Selects and executes the items or settings.
- 17 I/⏻ (POWER) button (19)**
Turns on and off the power of the player and TV.
- 18 SET UP button (42)**
Displays the setup display on the TV screen to set or adjust the items.
- 19 WIDE MODE button (55)**
Switches the wide picture on or off.
- 20 ENTER button**
Executes the items or settings.
- 21 TV/receiver operation buttons (55)**
Controls TVs and receivers (amplifiers).
- 22 SUBTITLE button (33)**
Displays the "SUBTITLE" menu in the Control Menu display.
- 23 TIME/TEXT button (24)**
Displays the playing time of the disc, etc., on the front panel display.
- 24 ◀◀/▶▶ SLOW buttons (20)**
Play a disc in slow motion.
- 25 ◀/▶ SCAN buttons (19, 20)**
Locate a point while monitoring the picture.
- 26 ■STOP button (19, 21)**
Stops playing a disc.
- 27 ■■PAUSE button (19)**
Pauses playing a disc.
- 28 DVD MENU button (22)**
Displays the DVD menu on the TV screen.
- 29 ↶RETURN button (23, 27)**
Press to return to the previously selected screen, etc.

Index

Numerics

- 2.1 Channel Surround 14, 53
- 4:3 LETTER BOX 46
- 4:3 PAN SCAN 46
- 5.1 Channel Surround 15
- 16:9 46

A

- A-B REPEAT 39
- A↔B Repeat 39
- Angle 34
- ANGLE 34
- AUDIO 32, 45
- AUDIO ATT 50
- AUDIO DRC 50
- AUDIO SETUP 50
- AUTO PLAY 47

B

- BACKGROUND 46
- Batteries 8

C

- CD 18
- Chapter 5, 29
- CHAPTER 29
- Color system 9
- Connecting 10, 12, 14, 15
- Continuous play
 - CD/VIDEO CD 18
 - DVD 18
- Control Menu display 26
- CUSTOM SETUP 47

D, E

- DIGITAL OUT 51
- Digital output 13, 15, 51
- DIMMER 47
- Display
 - Control Menu display 26
 - Front panel display 24
 - Setup display 42
- Dolby Digital 15, 32
- DTS 52
- DVD 18
- DVD MENU 22, 45

F, G

- Fast Forward 20
- Fast Reverse 20
- Front panel display 24

H, I, J, K

- Handling discs 7
- Hi-speed search 20
- Hooking up 10, 12, 14, 15
- INDEX 29

L

- LANGUAGE SETUP 45
- LETTER BOX 46
- Locating
 - a specific point 19
 - by observing the TV screen 20

M, N, O

- MPEG 51
- On-screen display
 - Control Menu display 26
 - Setup display 42
- OSD 45

P, Q

- PAN SCAN 46
- PARENTAL CONTROL 47
- PBC functions 23
- PBC Playback 23, 61
- PRO LOGIC 51
- PROGRAM 36
- Program Play 36

R

- Remote 8, 54
- REPEAT 39
- Resume Play 21

S

- S video output 10, 12, 14
- Scene 5
- SCENE 29
- SCREEN SAVER 46
- SCREEN SETUP 46
- Searching. See Locating.
- Setup display 42
- SHUFFLE 38

- Shuffle Play 38
- Slow-motion Play 20
- SPEAKER SETUP 53
- Speakers
 - hookup 14, 15
 - set up 53
- SUBTITLE 33

T

- TIME/TEXT 24
- Title 5, 29, 62
- TITLE 29
- Title menu 22
- Track 5, 29, 62
- TRACK 29
- TRACK SELECTION 50
- Troubleshooting 56
- TV TYPE 46

U

- Usable discs 4

V, W, X, Y, Z

- VES 35
- VIDEO CD 18
- VIRTUAL SURROUND 35

