

wena wrist pro
Startup Guide
Einführungsanleitung
Guide de démarrage
Guía de inicio

English Deutsch

■ wena wrist pro

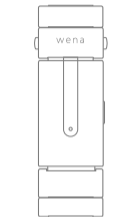

■ Charging clip
Ladeclip



■ microUSB cable
microUSB-Kabel



■ Adjuster piece
Einstellglied



■ Watch head link
Uhrengehäuseglied

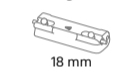

18 mm

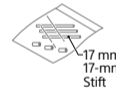

17 mm pin
17-mm-Stift

■ 19 mm pin
19-mm-Stift

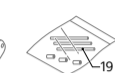

■ 20 mm

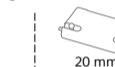

20 mm

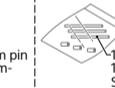

19 mm pin
19-mm-Stift

■ Startup Guide (this document)
Einführungsanleitung (dieses
Dokument)

■ Reference Guide
Referenzanleitung

■ Warranty sheet
Garantieblatt

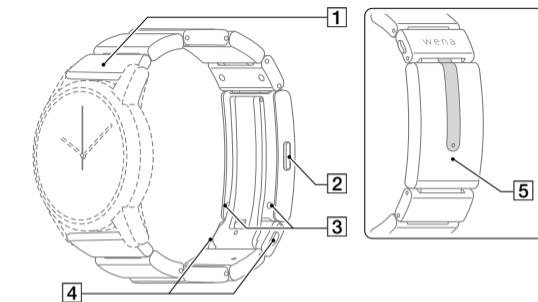

1 Watch head link
Uhrengehäuseglied

2 Power button
Ein-/Aus-Knopf

3 Battery charge terminals
Akkuladekontakte

4 Buckle release buttons
Verschlussentriegelungsknöpfe

5 NFC detection area
NFC-Erkennungsbereich

Attaching/removing the watch head
Anbringen/Abnehmen des Uhrengehäuses

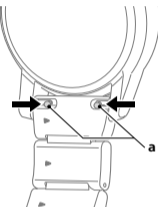

a: Slide latch knobs
a: Verriegelungsknöpfe verschieben

STEP 1: Charging the battery
SCHRITT 1: Aufladen des Akkus

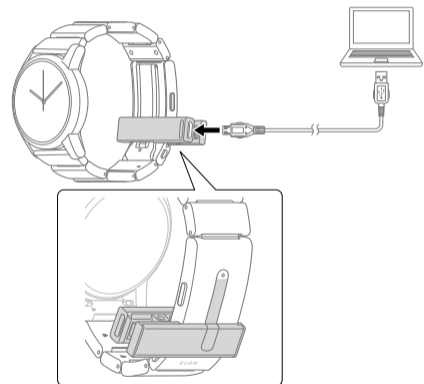

STEP 2: Installing the app
SCHRITT 2: Installieren der App



<http://wena.jp/downloads/apps.html>

STEP 3: Pairing with the smartphone
SCHRITT 3: Koppeln mit dem Smartphone



Follow the on-screen app instructions to enter the passkey (a) to establish a connection with the wena wrist pro.

Befolgen Sie zum Herstellen der Verbindung mit der wena wrist pro die Anweisungen in der App zur Eingabe des Passkeys (a).

Basic operations
Grundlegende Bedienung

Power on
Einschalten

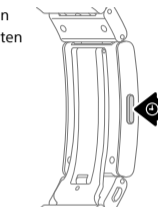

Power off
Ausschalten

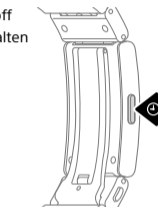

Activate/deactivate the Bluetooth function
Bluetooth-Funktion aktivieren/deaktivieren

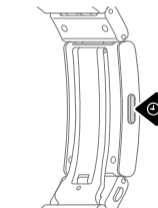

Français **Español**

■ wena wrist pro

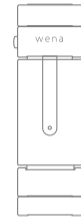

■ Clip de chargement
Clip de carga



■ Câble microUSB
Cable microUSB



3-TAC-155-11(1)
©2018 Sony Corporation
Printed in Japan

■ Pièce de réglage
Regulador

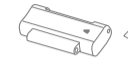

■ Maille de tête de montre
Eslabón para caja de reloj



18 mm

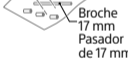

■ Guide de démarrage (ce document)
Guía de inicio (este documento)

■ Guide de référence
Guía de referencia

■ Feuille de garantie
Garantía



* 3 T A C 1 5 5 1 1 * (1)

Broche 19 mm
Pasador de 19 mm



20 mm



Broche 17 mm
Pasador de 17 mm

Broche 19 mm
Pasador de 19 mm

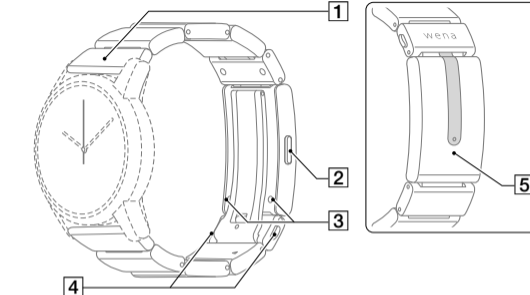

- 1 Maille de tête de montre
Eslabón para caja de reloj
- 2 Bouton d'alimentation
Botón de encendido
- 3 Bornes de chargement de batterie
Terminales de carga de la batería
- 4 Boutons de déverrouillage de sangle
Botones de apertura de la hebilla
- 5 Surface de détection NFC
Zona de detección NFC

**Fixation/retrait de la tête de la montre
Montaje/desmontaje de la caja del reloj**

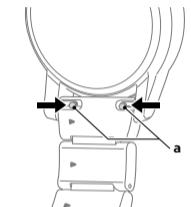

a : Loquets coulissants
a: Botones de cierre deslizante

**ÉTAPE 1 : Chargement de la batterie
PASO 1 : Carga de la batería**

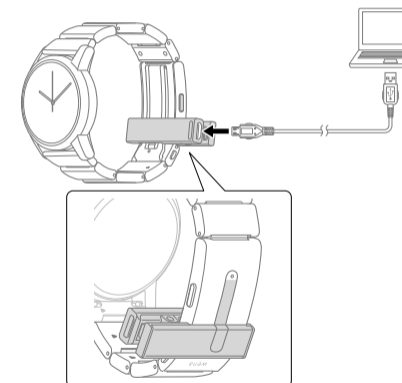

**ÉTAPE 2 : Installation de l'app
PASO 2 : Instalación de la app**



<http://wena.jp/downloads/apps.html>

**ÉTAPE 3 : Couplage avec le smartphone
PASO 3 : Emparejamiento con el smartphone**



Suivez les instructions de l'app à l'écran pour saisir la clé d'accès (a) afin d'établir une connexion avec le wena wrist pro.
Siga las instrucciones en pantalla de la app para escribir la clave de acceso (a) y establecer conexión con la pulsera wena wrist pro.

**Opérations élémentaires
Funcionamiento básico**

Alimentation activée
Encendido

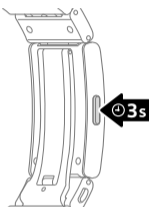

Alimentation désactivée
Apagado

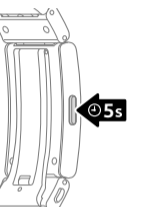

Activez/désactivez la fonction Bluetooth
Activar/desactivar la función Bluetooth

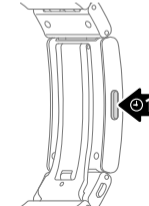

**Help Guide
Hilfe
Guide d'aide
Guía de ayuda**

English

<http://wena.jp/supports/helpguide.html#pro?country=uk>

Deutsch

<http://wena.jp/supports/helpguide.html#pro?country=de>

Français

<http://wena.jp/supports/helpguide.html#pro?country=fr>

Español

<http://wena.jp/supports/helpguide.html#pro?country=es>

