

# *Trinitron Color TV*

---

## Operating Instructions \_\_\_\_\_

**GB**

- Before operating the unit, please read this manual thoroughly and retain it for future reference.

**FD Trinitron**  
**WEGA**

*KV-HW21*

# WARNING

- Dangerously high voltages are present inside the TV.
- TV operating voltage: 110 – 240 V AC.
- Do not plug in the power cord until you have completed making all other connections; otherwise a minimum leakage current might flow through the antenna and other terminals to ground.
- To avoid battery leakage and damage to the remote, remove the batteries from the remote if you are not going to use it for several days. If any liquid leaks from the batteries and touches your skin, immediately wash it away with water.

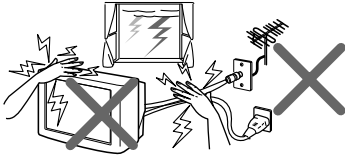

For your own safety, do not touch any part of the TV, the power cord and the antenna cable during lightning storms.

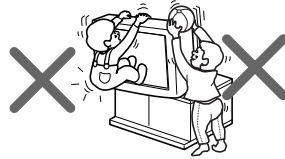

For children's safety, do not leave children alone with the TV. Do not allow children to climb onto it.

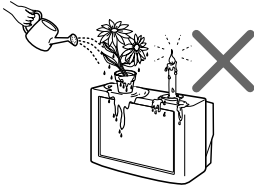

Do not place any objects on the TV. The apparatus shall not be exposed to dripping or splashing and that no objects filled with liquids, such as vases, shall be placed on the apparatus.

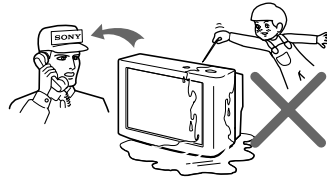

Do not operate the TV if any liquid or solid object falls into it. Have it checked immediately by qualified personnel only.

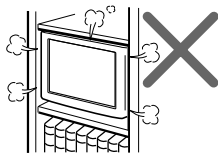

Do not block the ventilation openings of the TV. Do not install the TV in a confined space, such as a bookcase or built-in cabinet.

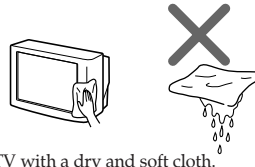

Clean the TV with a dry and soft cloth. Do not use benzine, thinner, or any other chemicals to clean the TV. Do not attach anything (e.g., adhesive tape, cellophane tape, glue) on the painted cabinet of the TV. Do not scratch the picture tube.

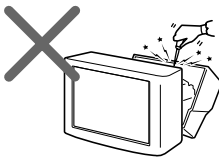

Do not open the cabinet and the rear cover of the TV as high voltages and other hazards are present inside the TV. Refer servicing and disposal of the TV to qualified personnel.

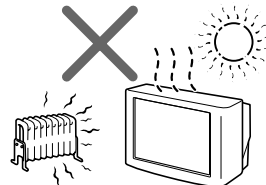

Your TV is recommended for home use only. Do not use the TV in any vehicle or where it may be subject to excessive dust, heat, moisture or vibrations.

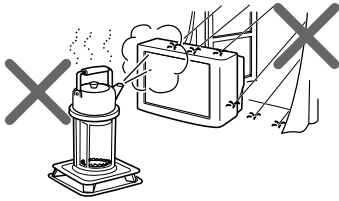

To prevent fire or shock hazard, do not expose the TV to rain or moisture.

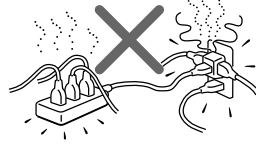

Do not plug in too many appliances to the same power socket. Do not damage the power cord.

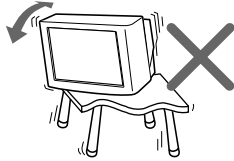

Install the TV on a stable TV stand and floor which can support the TV set weight. Ensure that the TV stand surface is flat and its area is larger than the bottom area of the TV.

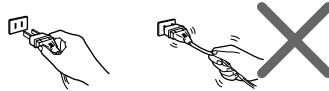

Pull the power cord out by the plug. Do not pull the power cord itself. Even if your TV is turned off, it is still connected to the AC power source (mains) as long as the power cord is plugged in. Unplug the TV before moving it or if you are not going to use it for several days.

## ■ Securing the TV

To prevent the TV from falling, use the supplied screws, clamps and band to secure the TV.

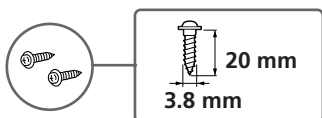

screws



clamps

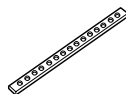

band

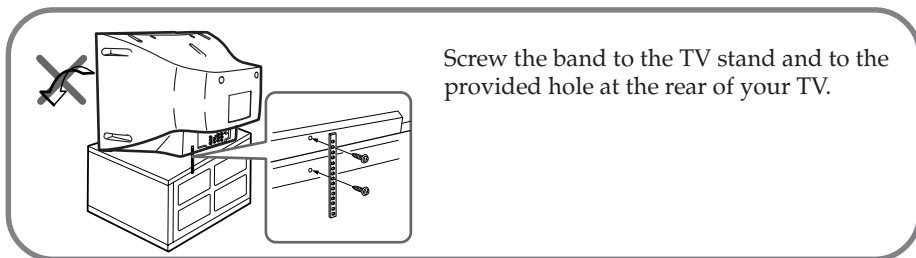

Screw the band to the TV stand and to the provided hole at the rear of your TV.

**or**

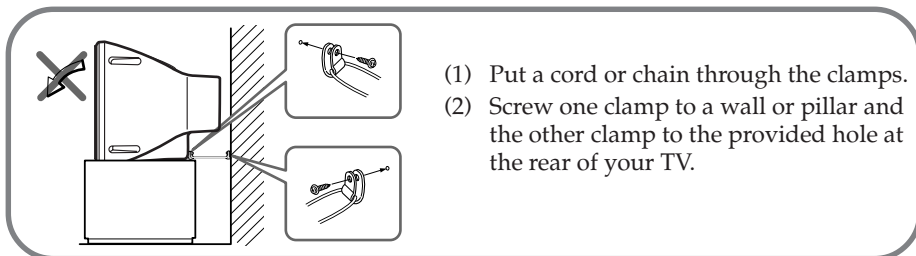

- (1) Put a cord or chain through the clamps.
- (2) Screw one clamp to a wall or pillar and the other clamp to the provided hole at the rear of your TV.

### Note

- Use only the supplied screws. Use of other screws may damage the TV.

---

# Table of Contents

---

## Installation

Getting Started .....	6
Setting up your TV ("Initial Setup") .....	7

---

## Overview of Controls

TV top control, front and rear panels .....	8
Using the remote control and basic functions .....	9

---

## Advanced Operations

Selecting the picture and sound modes .....	11
Enjoying stereo or bilingual programs .....	12

---

## Menu Adjustment

Introducing the menu system .....	13
Changing the "Video" setting .....	16
Changing the "Audio" setting .....	17
Changing the "Channel Setup" setting .....	19
Changing the "Channel Block" setting .....	20
Changing the "Timer" setting .....	21
Changing the "Setup" setting .....	22

---

## Additional Information

Connecting the 3D WOOFER (KV-HW21N63 only) .....	23
Connecting optional components ...	23
Troubleshooting .....	25
Specifications .....	Back cover

## ■ Getting Started

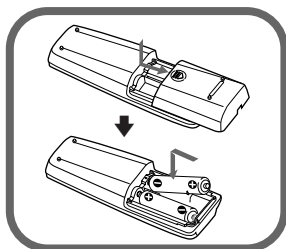

### Step 1

Insert the batteries (supplied) into the remote.

#### Note

- Do not use old or different types of batteries together.

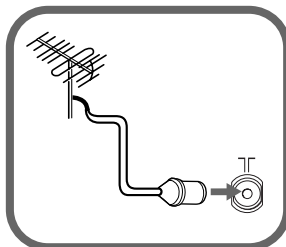

### Step 2

Connect the antenna cable (not supplied) to  $\Gamma$  (antenna input) at the rear of the TV.

#### Tip

- You can also connect your TV to other optional components (see page 23).

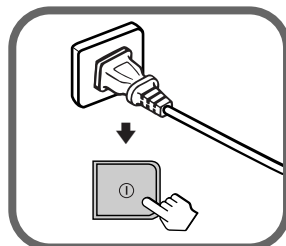

### Step 3

Plug in the power cord, then press  $\text{⏻}$  on the TV to turn it on.

#### Note

- The  $\text{⏻}$  (standby) indicator flashes green for a few seconds when turning on the TV. This does not indicate a malfunction.

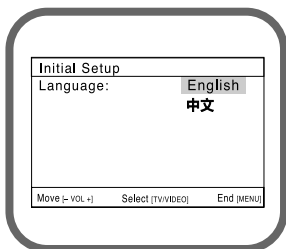



### Step 4

Set up the TV by following the instructions of the "Initial Setup" menu (see page 7).

## ■ Setting up your TV ("Initial Setup")

When you turn on your TV for the first time, the "Initial Setup" menu will appear. You may change the menu language and preset the TV channels automatically using the buttons on the top control panel.

### Tip

- The MENU,  and  buttons on the remote control can also be used for the operations below.

- 1 Press VOLUME +/- to select the desired menu language, then press TV/VIDEO.

The selected menu language appears.

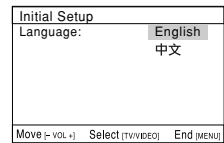

- 2 Press VOLUME +/- to select "Yes", then press TV/VIDEO to preset the channels automatically or select "No" to skip automatic channel presetting.

Once you select "Yes", your TV will start searching for all the available channels.

If the message "No channel found. Please connect cable/antenna." appears, check your TV connections, then press TV/VIDEO.

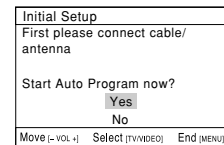

- 3 Press VOLUME +/- to select "No", then press TV/VIDEO. This menu will not appear again the next time you turn on the TV by pressing .

To allow this menu to appear again, select "Yes", then press TV/VIDEO.

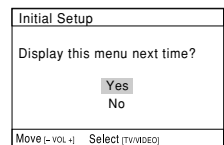

### Tips

- You can immediately go to the end of the "Initial Setup" menu by pressing MENU.
- You can also set up your TV by pressing the MENU button on the top control panel for about five seconds or using the menu system (see page 13).

## TV top control, front and rear panels

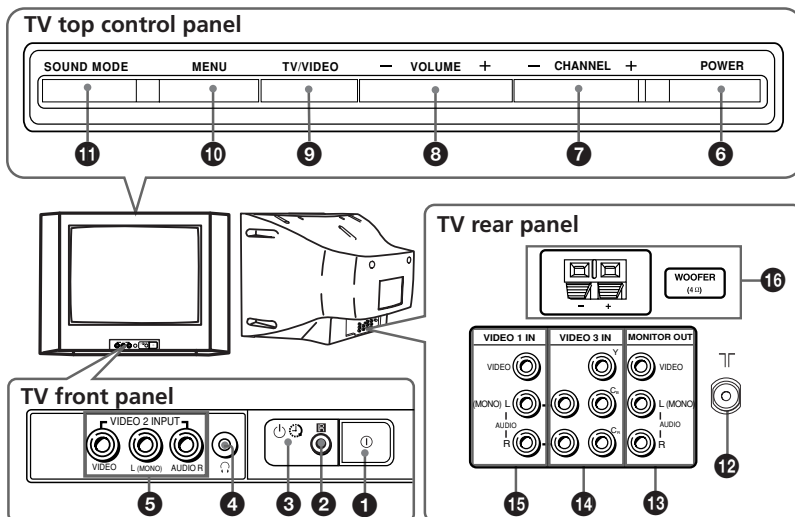

Button/Terminal	Function	Page
1	Turn off or turn on the TV.	6
2	Remote control sensor.	–
3	Wake Up indicator.	21
3	Standby indicator.	6
4	Headphone jack.	–
5 VIDEO 2 INPUT	Video input terminal 2.	23
6 POWER	Turn off temporarily or turn on the TV.	–
7 CHANNEL +/-	Select channel number.	–
8 VOLUME +/-	Adjust volume.	–
9 TV/VIDEO	Select TV or video input.	23
<b>Menu operations</b>		
8 VOLUME +/-	Select and adjust items.	–
9 TV/VIDEO	Confirm selected items.	–
10 MENU	Display or cancel the menu.	–
11 SOUND MODE	Select sound mode options with a 5-Band Graphic Equalizer display.	11
12	Antenna input terminal.	23
13 MONITOR OUT	Monitor output terminal.	24
14 VIDEO 3 IN	Component video input terminal.	24
15 VIDEO 1 IN	Video input terminal 1.	23
16 WOOFER (KV-HW21N63 only)	Enjoy high quality sound.	23



# Using the remote control and basic functions

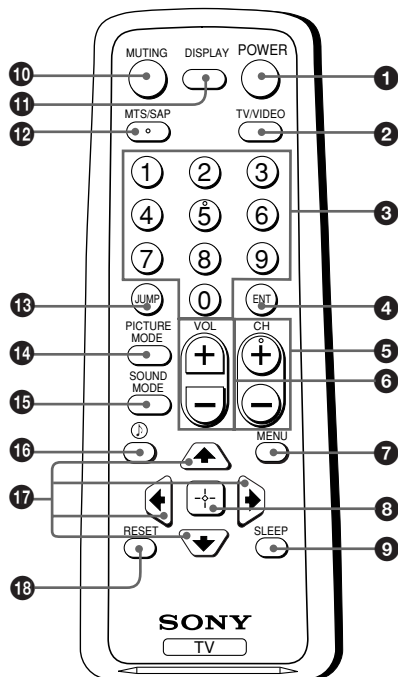



Button	Description	Page
1 POWER	Turn off temporarily or turn on the TV.	–
2 TV/VIDEO	Select TV or video input.	23
3 0–9	Input numbers.	–
4 ENT	Confirm input numbers.	–
5 CH +/-	Select channel number.	–
6 VOL +/-	Adjust volume.	–
10 MUTING	Mute the sound.	–
11 DISPLAY	Display on-screen information.	–
13 JUMP	Jump to previous channel number.	–

[continue](#)

---

**continued**

Button	Description	Page
14 PICTURE MODE	Select picture mode options.	11
15 SOUND MODE	Select sound mode options with a 5-Band Graphic Equalizer display.	11
16 	Select audio effect mode options: "Effect Off", "Simulated" (stereo-like monaural sound), "Surround".	-
18 RESET	Set TV to factory setting while adjusting items in an on-screen menu.	-
<b>Menu operations</b>		
7 MENU	Display or cancel the menu.	15
8 	Confirm selected items.	15
17 	Select and adjust items.	15
<b>Timer operations</b>		
9 SLEEP	Set TV to turn off automatically.	-
<b>Stereo/bilingual operations</b>		
12 MTS/SAP	Select stereo/bilingual mode.	12

## ■ Selecting the picture and sound modes

You can select picture and sound modes and adjust the setting to your personal preference.

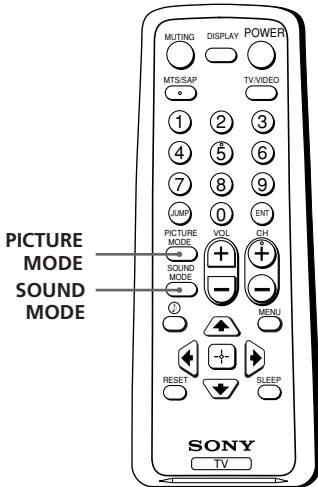



### Selecting the picture mode

Press PICTURE MODE to select the desired picture mode.

Select	To view
"Vivid"	contrast and sharp pictures.
"Standard"	standard pictures.
"Movie"	finely detailed pictures.
"Sports"	bright pictures.

### Selecting the sound mode

Press SOUND MODE on the remote control (or the top control panel) to select the desired sound mode with a 5-Band Graphic Equalizer display.

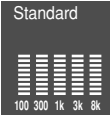
Select	To listen to
"Movie" 	dynamic and clear sound that emphasizes the low and high tones.
"News" 	sound that emphasizes vocals.
"Soft" 	soft, natural and relaxing sounds.
"Standard" 	standard flat sounds.

# ■ Enjoying stereo or bilingual programs

You can enjoy stereo sound or bilingual programs of MTS stereo system by using MTS/SAP button.

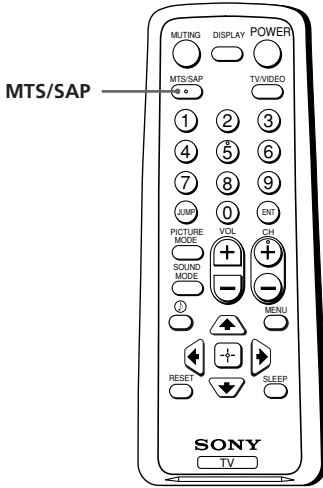

## Select stereo or bilingual programs

Press MTS/SAP until you receive the sound you want.

Select	To listen to
"Stereo"	stereo broadcast sound.
"Auto SAP"	SAP broadcast sound.
"Mono"	monaural sound.



### Notes

- When select "Auto SAP", non-SAP program sound will be same as "Stereo" mode sound.
- If the stereo signal is very weak, the stereo broadcast sound may become noisy. To reduce the noise select "Mono".

## ■ Introducing the menu system

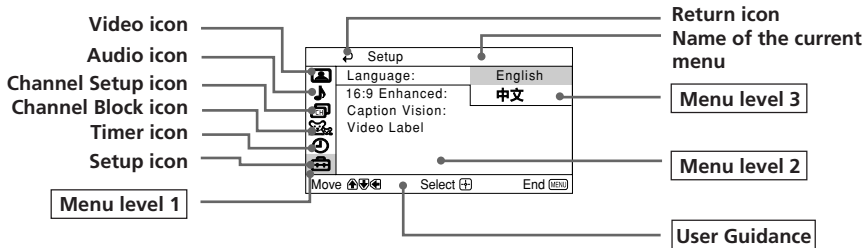



The MENU button lets you open a menu and change the settings of your TV. The following is an overview of the menu system.



Level 1	Level 2	Level 3/Function	Page
"Video" 	"Mode"	Select the picture mode: "Vivid" → "Standard" → "Movie" → "Sports"	16
	"Picture Controls"	Adjust the picture mode option: "Picture" → "Brightness" → "Color" → "Hue" → "Sharpness"	
	"Color Temp."	Adjust white color tint: "Cool" → "Neutral" → "Warm"	
	"Intelligent Picture"	Optimize picture quality: "On" → "Off"	
"Audio" 	"Mode"	Select the sound mode: "Movie" → "News" → "Soft" → "Standard"	17
	"Sound Controls"	Adjust sound frequency settings.	
	"Balance"	Select to emphasize the left and right speakers.	
	"Steady Sound"	Adjust volume automatically: "On" → "Off"	
	"Effect"	Select audio effect mode: "Off" → "Simulated" → "Surround"	
	"MTS"	Select stereo/bilingual mode: "Stereo" → "Auto SAP" → "Mono"	

continue

**continued**

Level 1	Level 2	Level 3/Function	Page
	"Favorite Channels"	Quick access to favorite channels.	19
	"Cable"	Watch cable TV programs: "On" → "Off"	
	"Auto Program"	Preset channels automatically.	
	"Channel Skip/Add"	Skip unwanted channels or add new ones.	
	"Channel Label"	Label the channel number.	
	—	Block unwanted channels.	20
	"Sleep"	Set TV to turn off automatically.	21
	"Wake Up Timer"	Set TV to turn on automatically.	
	"Language"	Change the menu language: "English" → "中文" (Chinese)	22
	"16:9 Enhanced"	Change the picture size: "On" → "Off"	
	"Caption Vision"	Select the closed caption mode: "Off" → "CC1/2/3/4" → "Text1/2/3/4" → "Info"	
	"Video Label"	Label the connected equipment.	

## How to use the menu

Press MENU to display the menu.

Press  $\uparrow$  or  $\downarrow$  to select the desired item.

Press  $\rightarrow$  (or  $\rightarrow$ ) to confirm your selection and go to the next level.

## Other menu operations

To	Press
Adjust the setting value	$\uparrow$ , $\downarrow$ , $\leftarrow$ or $\rightarrow$ .
Move to the next/previous menu level	$\leftarrow$ or $\rightarrow$ .
Cancel the menu	MENU.

### Tips

- If you want to exit from Menu level 2 to Menu level 1, press  $\uparrow$  or  $\downarrow$  until the return icon ( $\curvearrowright$ ) is highlighted, then press  $\rightarrow$ .
- The MENU, TV/VIDEO and VOLUME +/- buttons on the top control panel can also be used for the operations above (see page 8).

# ■ Changing the “Video” setting

The “Video” menu allows you to adjust the picture settings.

**1** Press MENU.

**2** Make sure the “Video” icon (📺) is selected, then press (↔).

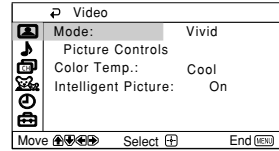

**3** Press ↑ or ↓ to select the desired item (e.g., “Mode”), then press (↔).

Select	To
“Mode”	choose either “Vivid”, “Standard”, “Movie” or “Sports” (see page 11). <b>Tip</b> <ul style="list-style-type: none"><li>You can adjust the setting to your personal preference in the “Picture Controls” option.</li></ul>
“Color Temp.” (Color Temperature)	adjust white color tint. Choose either “Cool” (blue tint), “Neutral” (neutral tint) or “Warm” (red tint).
“Intelligent Picture”	optimize picture quality. Press ↑ or ↓ to select “On”, then press (↔). To cancel, select “Off”, then press (↔).

## Adjusting the “Picture Controls” items

**1** Press ↓ to select “Picture Controls”, then press (↔).

**2** Press ↑ or ↓ to select either “Picture” (contrast), “Brightness”, “Color”, “Hue” (color tones) or “Sharpness”, then press (↔).

Pressing RESET button on the remote control will set your TV to the factory setting.

**3** Press ↑, ↓, ← or → to adjust the setting of your selected item, then press (↔).

**4** Repeat the above steps to adjust other items.

The adjusted settings will be memorized.

### Note

- Reducing “Sharpness” can also reduce picture noise.



# ■ Changing the “Audio” setting

The “Audio” menu allows you to adjust the sound settings.

- 1 Press MENU.
- 2 Press **▲** or **▼** to select the “Audio” icon ( **🔊** ), then press **⏏**.

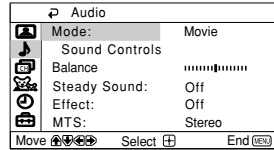

- 3 Press **▲** or **▼** to select the desired item (e.g., “Mode”), then press **⏏**.

Select	To
“Mode”	choose either “Movie”, “News”, “Soft” or “Standard” (see page 11). <b>Tip</b> • You can adjust the setting to your personal preference in the “Sound Controls” option (see page 18).
“Balance”	Press <b>▼</b> or <b>◀</b> to emphasize the left speaker. Press <b>▲</b> or <b>▶</b> to emphasize the right speaker.
“Steady Sound”	adjust the volume of all channel numbers and video inputs automatically. Press <b>▲</b> or <b>▼</b> to select “On”, then press <b>⏏</b> . To cancel, select “Off”, then press <b>⏏</b> .
“Effect”	choose either “Off”, “Simulated” or “Surround” (see page 10).
“MTS” (Multi-Channel TV Sound)	choose either “Stereo”, “Auto SAP” or “Mono”. <b>Tip</b> • You can also access the setting by pressing the MTS/SAP button on the remote control (see page 12).

continue

---

**continued**

## Adjusting the “Sound Controls” items

The 5-Band Graphic Equalizer feature allows you to adjust sound frequency settings to your personal preference in the menu.

- 1 Press **↓** to select “Sound Controls”, then press **⏏**.

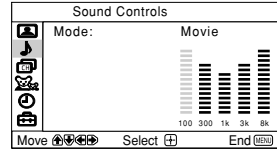

- 2 Press **→** or **←** to select the desired sound frequency, then press **↑** or **↓** to adjust the setting and press **⏏**.

The adjusted settings will be memorized.

Pressing RESET button on the remote control will set your TV to the factory setting.

---

### Notes

- Adjusting higher frequency will affect higher pitched sound and adjusting lower frequency will affect lower pitched sound.
- You may display the settings directly using the SOUND MODE button on the top control panel (see page 8) or the remote control (see page 10).

# ■ Changing the “Channel Setup” setting

The “Channel Setup” menu allows you to quickly access favorite channels, receive cable TV programs, preset channels automatically, skip unwanted channels or add new ones and label the channel number.

**1** Press MENU.

**2** Press  $\uparrow$  or  $\downarrow$  to select the “Channel Setup” icon (CH), then press  $\left[ \begin{smallmatrix} \uparrow \\ \downarrow \end{smallmatrix} \right]$ .

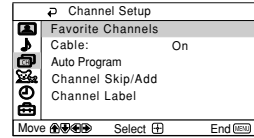

**3** Press  $\uparrow$  or  $\downarrow$  to select the desired item (e.g., “Favorite Channels”), then press  $\left[ \begin{smallmatrix} \uparrow \\ \downarrow \end{smallmatrix} \right]$ .

Select	To
“Favorite Channels”	quickly access favorite channels. (1) Press $\uparrow$ or $\downarrow$ to select the position you want to set a favorite channel, then press $\left[ \begin{smallmatrix} \uparrow \\ \downarrow \end{smallmatrix} \right]$ . (2) Press $\uparrow$ or $\downarrow$ to select the desired channel, then press $\left[ \begin{smallmatrix} \uparrow \\ \downarrow \end{smallmatrix} \right]$ . To use “Favorite Channels”: Exit all menus and press $\left[ \begin{smallmatrix} \uparrow \\ \downarrow \end{smallmatrix} \right]$ . Press $\uparrow$ or $\downarrow$ to move the cursor to the desired channel number and press $\left[ \begin{smallmatrix} \uparrow \\ \downarrow \end{smallmatrix} \right]$ .
“Cable”	receive cable TV programs. Press $\uparrow$ or $\downarrow$ to select “On”, then press $\left[ \begin{smallmatrix} \uparrow \\ \downarrow \end{smallmatrix} \right]$ . If you select “Cable: On”, you will be able to receive 125 cable TV channels. If there are no cable TV channels, you will receive VHF broadcast channels only. To receive only VHF and UHF broadcast channels, select “Off”, then press $\left[ \begin{smallmatrix} \uparrow \\ \downarrow \end{smallmatrix} \right]$ .
“Auto Program”	preset channels automatically.
“Channel Skip/Add”	skip unwanted channels or add new ones. (1) Press $\uparrow$ or $\downarrow$ to select the desired channel, then press $\left[ \begin{smallmatrix} \uparrow \\ \downarrow \end{smallmatrix} \right]$ . (2) Press $\uparrow$ or $\downarrow$ to select either “Skip” or “Add”, then press $\left[ \begin{smallmatrix} \uparrow \\ \downarrow \end{smallmatrix} \right]$ .
“Channel Label”	label the channel number. (1) Select “Channel” and press $\left[ \begin{smallmatrix} \uparrow \\ \downarrow \end{smallmatrix} \right]$ . Press $\uparrow$ or $\downarrow$ to select the channel number, then press $\left[ \begin{smallmatrix} \uparrow \\ \downarrow \end{smallmatrix} \right]$ . (2) Select “Label” and press $\left[ \begin{smallmatrix} \uparrow \\ \downarrow \end{smallmatrix} \right]$ , then press $\uparrow$ or $\downarrow$ to select alphanumeric characters for the label.

## Note

- You can skip over channels that have been skipped by pressing CH +/- . You can still use the 0-9 buttons to directly tune to skipped channels.

# ■ Changing the “Channel Block” setting

The “Channel Block” menu allows you to block unwanted channels.

- 1 Press MENU.
- 2 Press **↑** or **↓** to select the “Channel Block” icon (🔒), then press **↵**.

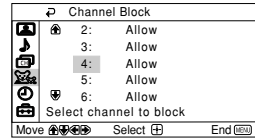

- 3 Press **↑** or **↓** to select the desired channel, then press **↵**.
- 4 Press **↑** or **↓** to select “Block” or “Allow”, then press **↵**.

## Notes

- When you first enter the “Channel Block” menu, the channel highlighted is the current channel that is being viewed.
- When a channel is blocked, the word “Blocked” and lock symbol (🔒) will appear on the black screen.
- “Channel Block” is disabled when in video mode.

# ■ Changing the “Timer” setting

The “Timer” menu allows you to set TV to turn off and turn on automatically.

**1** Press MENU.

**2** Press  $\uparrow$  or  $\downarrow$  to select the “Timer” icon (⌚), then press  $\left[ \begin{smallmatrix} \uparrow \\ \downarrow \end{smallmatrix} \right]$ .

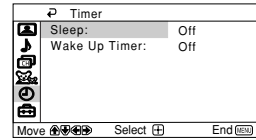

**3** Press  $\uparrow$  or  $\downarrow$  to select the desired item (e.g., “Sleep”), then press  $\left[ \begin{smallmatrix} \uparrow \\ \downarrow \end{smallmatrix} \right]$ .

Select	To
“Sleep”	set TV to turn off automatically. Press $\uparrow$ or $\downarrow$ to select the desired period of time (max. of 90 minutes), then press $\left[ \begin{smallmatrix} \uparrow \\ \downarrow \end{smallmatrix} \right]$ .
“Wake Up Timer”	set TV to turn on automatically. Press $\uparrow$ or $\downarrow$ to select the desired period of time (max. of 12 hours), then press $\left[ \begin{smallmatrix} \uparrow \\ \downarrow \end{smallmatrix} \right]$ . After the selected length of time, the TV switches on automatically and “Wake Up Timer” will appear on the screen.  The ⌚ indicator on the TV lights up amber once you set the “Wake Up Timer”.

## Notes

- You can also cancel “Sleep” and “Wake Up Timer” by turning off the TV’s main power.
- If no buttons or controls are pressed for more than one hour after the TV is turned on using the “Wake Up Timer”, the TV automatically goes into standby mode.

# ■ Changing the “Setup” setting

The “Setup” menu allows you to change the menu language, change the picture size, select the closed caption mode and label the connected equipment.

**1** Press MENU.

**2** Press **▲** or **▼** to select the “Setup” icon (⏏), then press (↵).

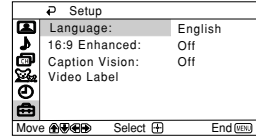

**3** Press **▲** or **▼** to select the desired item (e.g., “Language”), then press (↵).

Select	To
“Language”	change the menu language. Press <b>▲</b> or <b>▼</b> to select either “English” or “中文” (Chinese), then press (↵).
“16:9 Enhanced”	change the picture size. Choose either “On” or “Off”.
“Caption Vision”	select the closed caption mode. Press <b>▲</b> or <b>▼</b> to select either “Off”, “CC1/2/3/4” (printed dialogue and sound effects), “Text1/2/3/4” (network/station information) or “Info” (name of current program and remaining time).
“Video Label”	label the connected equipment. (1) Select “Video Input” and press (↵). Press <b>▲</b> or <b>▼</b> to select the input you want to label, then press (↵). (2) Select “Label” and press (↵), then press <b>▲</b> or <b>▼</b> to select the label options: “Video 1/2/3”, “VCR”, “Cable”, “DVD” or “Customize”.* * You may customize the video label by entering alphanumeric characters.

## ■ Connecting the 3D WOOFER

► KV-HW21N63 only

You can enjoy high quality sound by connecting the 3D WOOFER as follows:

### Step 1

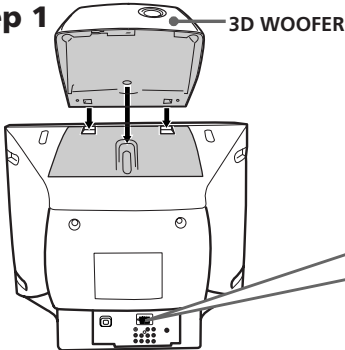

### Step 2

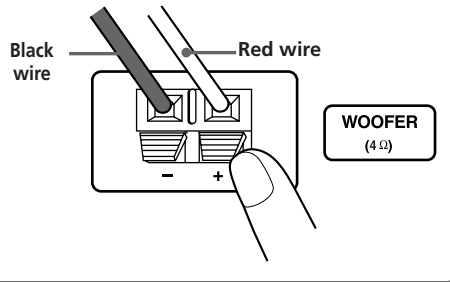

#### Notes

- Connect only the supplied 3D WOOFER; otherwise your TV may malfunction.
- Unplug your TV from the wall outlet when connecting the 3D WOOFER.
- To prevent a malfunction caused by a short circuit of the terminals, make sure that none of the 3D WOOFER wire strands stick out, making contact with the neighbouring 3D WOOFER terminal.

## ■ Connecting optional components

### Connecting to VIDEO 2 INPUT and VIDEO 1 IN terminals

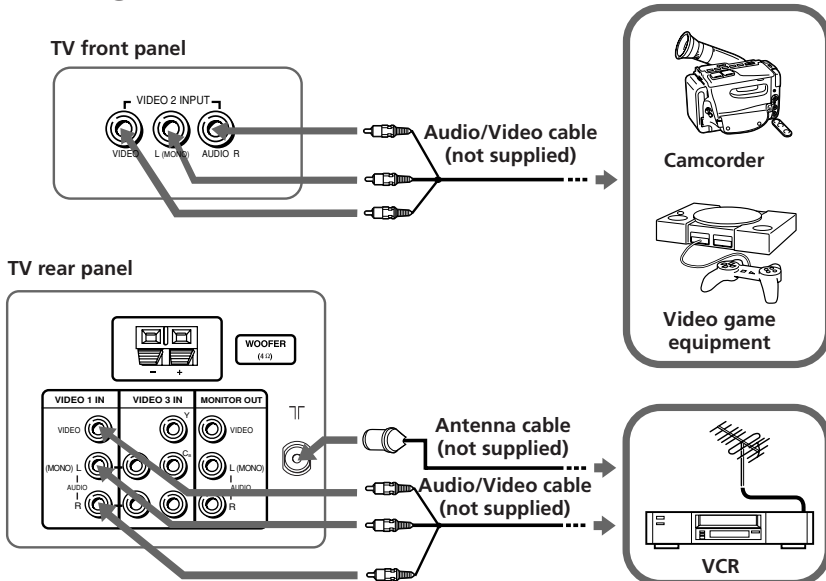

continue

**continued**

## Connecting to MONITOR OUT terminal

TV rear panel

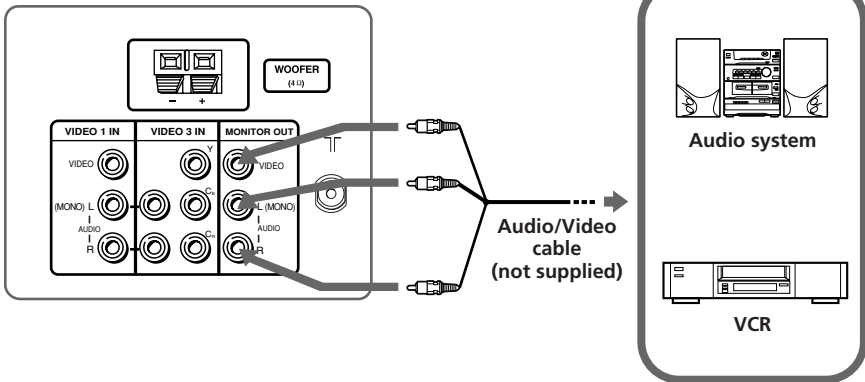

## Connecting to VIDEO 3 IN terminal

TV rear panel

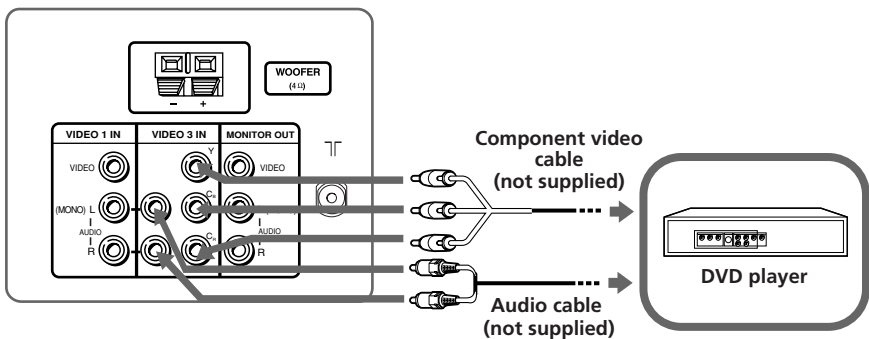

### Notes

- If your DVD player can output interlace and progressive mode signals, select the interlace output when connecting to VIDEO 3 IN on your TV. Your TV can receive either 525i/60Hz or 625i/50Hz interlace signals.
- Some DVD player terminals may be labeled differently:

Connect	To (on the DVD player)
Y (green)	Y
C <sub>B</sub> (blue)	C <sub>B</sub> , P <sub>B</sub> , C <sub>b</sub> or B-Y
C <sub>R</sub> (red)	C <sub>R</sub> , P <sub>R</sub> , C <sub>r</sub> or R-Y









- If you select "Video 3" on your TV screen, the signal from the MONITOR OUT will not be output properly. This does not indicate a malfunction.

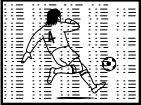

# Troubleshooting





If you find any problem while viewing your TV, please check the following guide. If any problem persists, contact your Sony dealer.



## Troubleshooting guide

Symptom	Possible cause	Solutions	Page
<b>Snowy picture</b> 	<ul style="list-style-type: none"> <li>The connection is loose or the cable is damaged.</li> <li>The antenna setup is inappropriate.</li> </ul>	<ul style="list-style-type: none"> <li>Check the antenna cable and connection on the TV, VCR and at the wall.</li> <li>Check the antenna setup. Contact a Sony dealer for advice.</li> </ul>	23 -
<b>Noisy sound</b> 	<ul style="list-style-type: none"> <li>Channel presetting is inappropriate or incomplete.</li> <li>Signal transmission is low.</li> </ul>	<ul style="list-style-type: none"> <li>Preset the channel again.</li> <li>Try using a booster.</li> </ul>	19 -
<b>Distorted picture</b> 	<ul style="list-style-type: none"> <li>Broadcast signals are too strong.</li> </ul>	<ul style="list-style-type: none"> <li>Turn off or disconnect the booster if it is in use.</li> </ul>	-
<b>Noisy sound</b> 			
<b>No picture</b> 	<ul style="list-style-type: none"> <li>The power cord, antenna or VCR is not connected.</li> <li>The TV is not turned on.</li> </ul>	<ul style="list-style-type: none"> <li>Check the power cord, antenna and VCR connections.</li> <li>Press POWER.</li> <li>Press ① (main power) on the TV to turn off the TV for about five seconds, then turn it on again.</li> </ul>	23 8, 9 8
<b>No sound</b> 			
<b>Good picture</b> 	<ul style="list-style-type: none"> <li>The volume level is too low.</li> <li>The sound is muted.</li> </ul>	<ul style="list-style-type: none"> <li>Press VOL + to increase the volume level.</li> <li>Press MUTING to cancel the muting.</li> </ul>	9 9
<b>No sound</b> 			

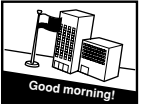
continue

**continued**

Symptom	Possible cause	Solutions	Page
<b>Dotted lines or stripes</b> 	<ul style="list-style-type: none"> <li>There is local interference from cars, neon signs, hair dryers, power generators, etc.</li> </ul>	<ul style="list-style-type: none"> <li>Do not use a hair dryer or other equipment near the TV.</li> <li>Check the antenna setup. Contact a Sony dealer for advice.</li> </ul>	<p>–</p> <p>–</p>
<b>Double images or "ghosts"</b> 	<ul style="list-style-type: none"> <li>Broadcast signals are reflected by nearby mountains or buildings.</li> </ul>	<ul style="list-style-type: none"> <li>Use a highly directional antenna.</li> </ul>	–
	<ul style="list-style-type: none"> <li>The antenna setup is inappropriate.</li> </ul>	<ul style="list-style-type: none"> <li>Check the antenna setup. Contact a Sony dealer for advice.</li> </ul>	–
<b>No color</b> 	<ul style="list-style-type: none"> <li>The color level setting is too low.</li> </ul>	<ul style="list-style-type: none"> <li>Display the "Video" menu and select the desired picture mode, then adjust the "Color" level in "Picture Controls".</li> </ul>	16
	<ul style="list-style-type: none"> <li>The antenna setup is inappropriate.</li> </ul>	<ul style="list-style-type: none"> <li>Check the antenna setup. Contact a Sony dealer for advice.</li> </ul>	–
<b>Picture slant</b> 	<ul style="list-style-type: none"> <li>The magnetic disturbance from external speakers or other equipment, or the direction of the earth's magnetic field may affect the TV.</li> </ul>	<ul style="list-style-type: none"> <li>Keep external speakers or other electrical equipment away from the TV.</li> </ul>	–
<b>Abnormal color patches</b> 	<ul style="list-style-type: none"> <li>The magnetic disturbance from external speakers or other equipment, or the direction of the earth's magnetic field may affect the TV.</li> </ul>	<ul style="list-style-type: none"> <li>Keep external speakers or other equipment away from the TV. Do not move the TV while the TV is turned on. Press <math>\text{\textcircled{O}}</math> (main power) on the TV to turn off the TV for about 15 minutes, then turn it on again to demagnetize the TV.</li> </ul>	–
<b>TV cannot receive stereo broadcast sound.</b>  <b>or</b>	<ul style="list-style-type: none"> <li>The stereo reception setting is inappropriate.</li> </ul>	<ul style="list-style-type: none"> <li>Press MTS/SAP until "Stereo" appears on the screen.</li> </ul>	12
<b>Stereo broadcast sound switches on and off or is distorted.</b>	<ul style="list-style-type: none"> <li>The connection is loose or the cable is damaged.</li> </ul>	<ul style="list-style-type: none"> <li>Check the antenna cable and connection on the TV, VCR and at the wall.</li> </ul>	23
	<ul style="list-style-type: none"> <li>The antenna setup is inappropriate.</li> </ul>	<ul style="list-style-type: none"> <li>Check the antenna setup. Contact a Sony dealer for advice.</li> </ul>	–

Symptom	Possible cause	Solutions	Page
The  (standby) indicator on your TV flashes red several times after every three seconds.	<ul style="list-style-type: none"> <li>Your TV's self-diagnosis function indicates the possible problems.</li> </ul>	<ul style="list-style-type: none"> <li>Count the number of times the  (standby) indicator flashes. Press  (main power) to turn off your TV. Contact your nearest Sony service center.</li> </ul>	-
TV cabinet creaks.	<ul style="list-style-type: none"> <li>Changes in room temperature sometimes make the TV cabinet expand or contract, causing a noise. This does not indicate a malfunction.</li> </ul>	-	-
A small "boom" sound is heard when the TV is turned on.	<ul style="list-style-type: none"> <li>The TV's demagnetizing function is working. This does not indicate a malfunction.</li> </ul>	-	-

# ■ Specifications

	KV-HW21N63	KV-HW21N60	Note
<b>Power requirements</b>	110-240 V AC, 50/60 Hz		
<b>Power consumption (W)</b>	Indicated on the rear of the TV		
<b>Television system</b>	M		
<b>Color system</b>	NTSC3.58		
<b>Stereo/Bilingual system</b>	MTS		
<b>Channel coverage</b>	VHF : 2 to 13 UHF : 14 to 69 CATV : 1 to 125		
<b>⏏ (Antenna)</b>	75-ohm external terminal		
<b>Audio output (Speaker)</b>	3 W + 3 W	5 W + 5 W	
<b>3D WOOFER</b>	9 W	—	
<b>Number of terminal</b>			
<b>VIDEO</b>	Input: 2      Output: 1	Phono jacks; 1 Vp-p, 75 ohms	
<b>AUDIO</b>	Input: 2      Output: 1	Phono jacks; 500 mVrms	
<b>VIDEO 3 IN</b>	Input: 1	Phono jacks; Y: 1 Vp-p, 75 ohms, sync negative C <sub>B</sub> : 0.7 Vp-p, 75 ohms C <sub>R</sub> : 0.7 Vp-p, 75 ohms Audio: 500 mVrms	
<b>🎧 (Headphone)</b>	Output: 1	Stereo minijack	
<b>Picture tube</b>	21 in.		
<b>Tube size</b>	545 mm		Measured diagonally
<b>Viewing screen size</b>	507 mm		Measured diagonally
<b>Dimensions (w/h/d)</b>	630 × 470 × 492 mm	630 × 460 × 492 mm	
<b>Mass</b>	27 kg	25 kg	

Design and specifications are subject to change without notice.