



Gids voor snelle instelling/Guida di configurazione rapida

DAV-DZ680/DZ780

Raadpleeg de Gebruiksaanwijzing voor meer informatie.
Per ulteriori informazioni, consultare le Istruzioni per l'uso.

1 De luidsprekers aansluiten/Collegamento dei diffusori

2 De tv aansluiten/Collegamento del televisore

Verbind de luidsprekerkabels met de SPEAKER-aansluitingen op het toestel die dezelfde kleur hebben.

Collegare i cavi del diffusore rispettando i colori sulle prese SPEAKER dell'unità.

Selecteer de aansluitingswijze voor video en audio afhankelijk van de aansluitingen op uw tv.
Selezionare il metodo di collegamento audio e video in base alle prese disponibili sul televisore.

Videoverbindingsmethode/Metodo di collegamento video

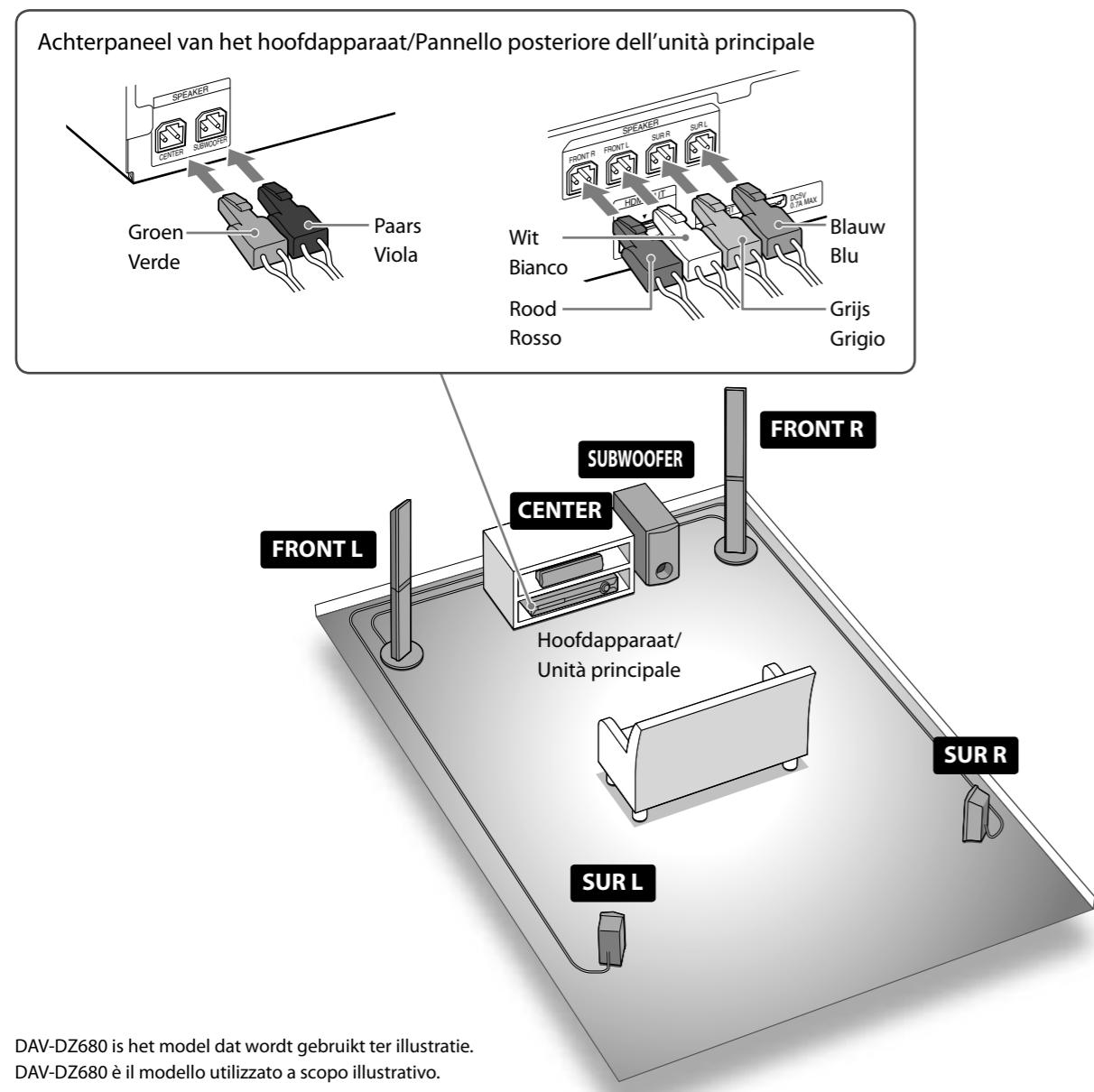

Methode 1/Metodo 1

Methode 2/Metodo 2

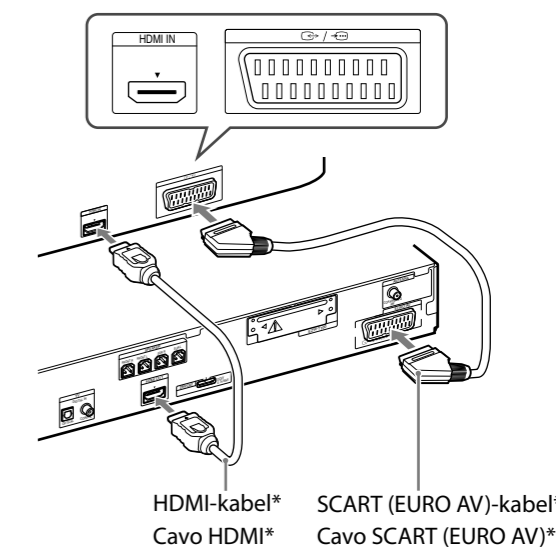
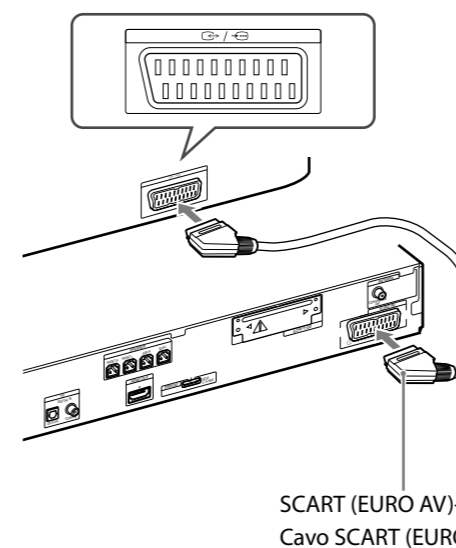

*Niet bijgeleverd/Non in dotazione

DAV-DZ680 is het model dat wordt gebruikt ter illustratie.
DAV-DZ680 è il modello utilizzato a scopo illustrativo.

De luidsprekerkabels aansluiten op de luidspreker/Per collegare i cavi del diffusore al diffusore

Audioverbindingsmethode/Metodo di collegamento audio

Methode 1/Metodo 1

Methode 2/Metodo 2

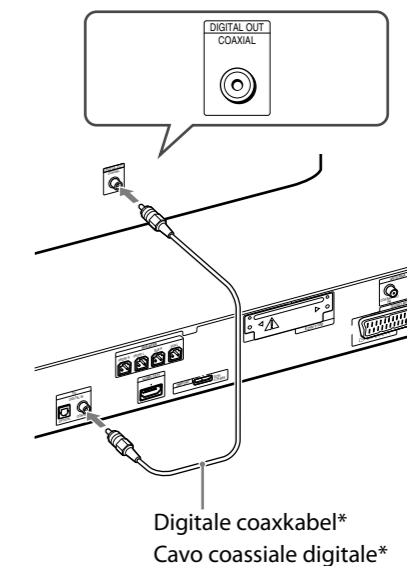
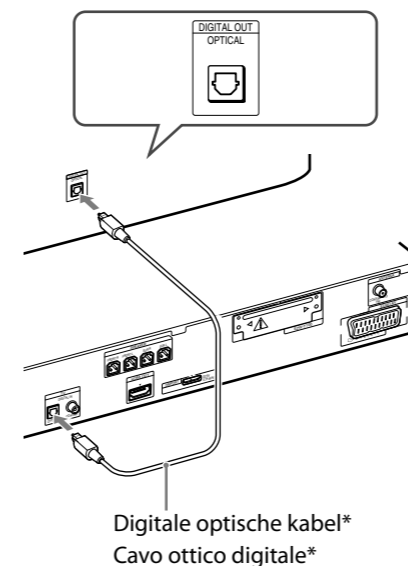
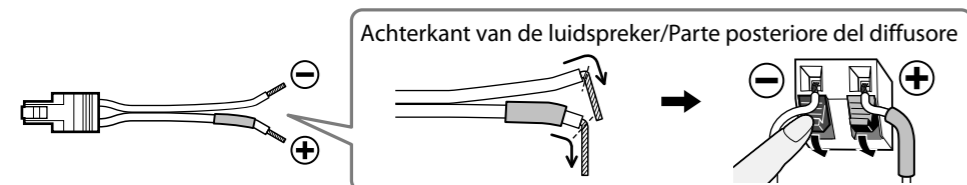

*Niet bijgeleverd/Non in dotazione

3 De snelle instelling uitvoeren/Esecuzione della configurazione rapida

Opmerking

Plaats geen disc voor u de snelle instelling hebt uitgevoerd.

Nota

Non inserire alcun disco prima di eseguire la configurazione rapida.

1 Sluit het netsnoer aan.

De vorm van het stopcontact verschilt naargelang de regio.

Collegamento del cavo di alimentazione CA.

La forma della presa a muro varia a seconda della zona geografica.

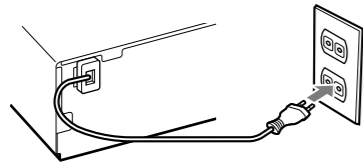

2 Schakel het hoofdapparaat en de tv in.

Accendere l'unità principale e il televisore.

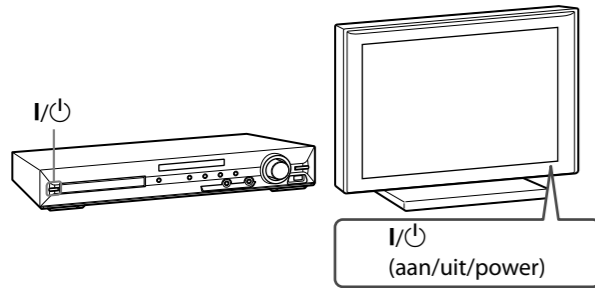

3 Wijzig de invoer van uw tv zodat "SONY Home Theatre System" wordt weergegeven.

Impostare il selettore di ingresso del televisore per visualizzare "SONY Home Theatre System".

4 Stel de volgende items in met $\leftarrow/\uparrow/\downarrow/\rightarrow$ en \oplus .

Impostare ciascuna delle seguenti voci, mediante $\leftarrow/\uparrow/\downarrow/\rightarrow$ e \oplus .

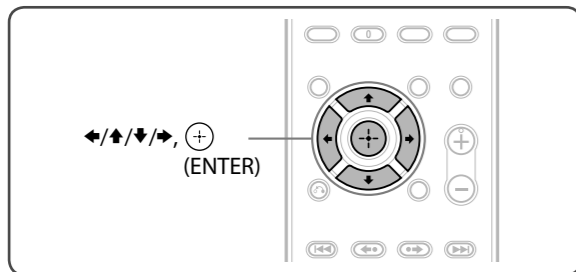

Opmerking

De weergegeven items verschillen naargelang de regio.

Nota

Le voci visualizzate dipendono dal paese di utilizzo.

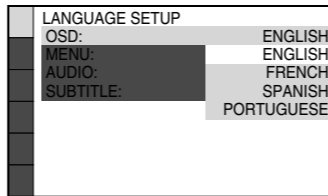
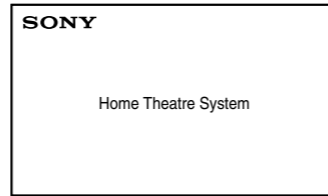

Selecteer een schermtaal.
Selezionare una lingua a schermo.

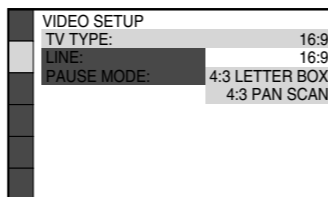

Selecteer de breedte-/hoogteverhouding van de aangesloten tv.
Selezionare il rapporto di formato del televisore collegato.

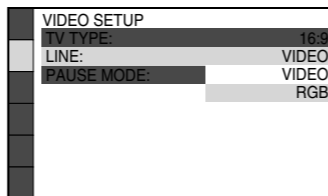

Selecteer de uitvoermethode voor videosignalen.
Selezionare il metodo di uscita dei segnali video.

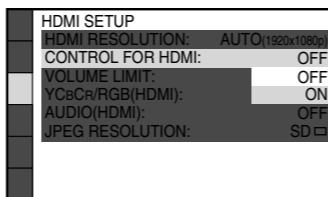

Selecteer [AAN] wanneer u het hoofdapparaat en de tv aansluit met een HDMI-kabel.
Selezionare [ON] quando si collegano l'unità principale e il televisore con un cavo HDMI.



Selecteer de luidsprekeropstelling.

Selezionare la disposizione dei diffusori.

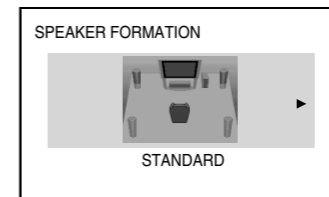

Sluit de kalibratiemicrofoon aan en plaats deze op de luisterpositie.

Collegare il microfono di calibrazione e impostarlo sulla posizione di ascolto.

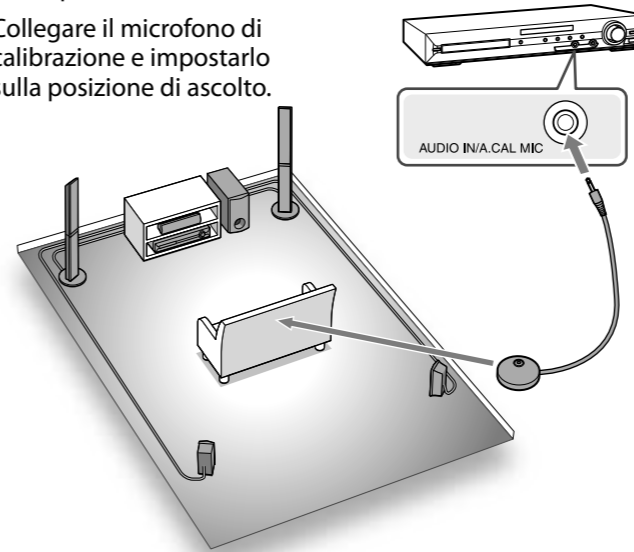

Selecteer [JA] om [AUTOKALIBRATIE] uit te voeren.

Selezionare [S] per eseguire [CALIBRAZIONE AUTO].

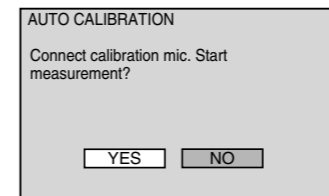

Selecteer [JA] om de meetresultaten op te slaan.

Selezionare [S] per salvare i risultati della misurazione.

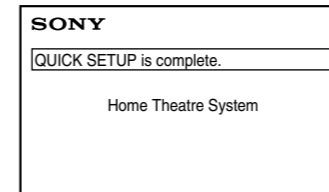
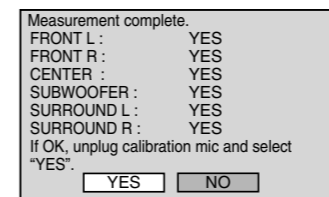

Luisteren naar het geluid van de tv via alle luidsprekers/Ascolto dell'audio del televisore da tutti i diffusori

1 Druk op FUNCTION +/- om "TV" weer te geven.

Premere FUNCTION +/- per visualizzare "TV".

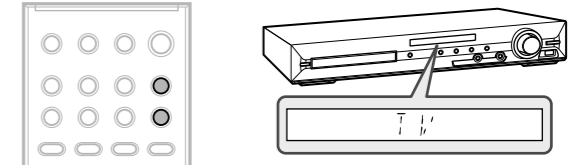

2 Druk op SYSTEM MENU.

Premere SYSTEM MENU.

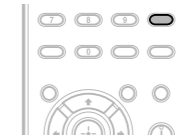

3 Druk op \uparrow/\downarrow om "DEC. MODE" weer te geven en druk daarna op \oplus .

Premere \uparrow/\downarrow per visualizzare "DEC. MODE", quindi premere \oplus .

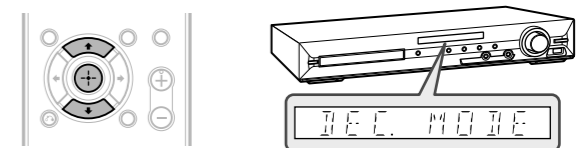

4 Druk op \uparrow/\downarrow om "PRO LOGIC" weer te geven en druk daarna op \oplus .

Premere \uparrow/\downarrow per visualizzare "PRO LOGIC", quindi premere \oplus .

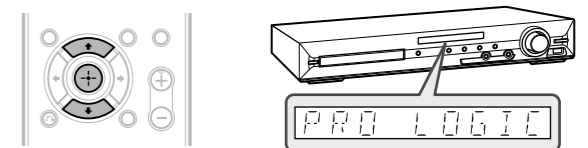

5 Druk op SYSTEM MENU om het menu te verlaten. Premere SYSTEM MENU per uscire dal menu.

