



Quick Setup Guide/快速設定指南

BDV-E800W

©2009 Sony Corporation Printed in Malaysia

1 Connect the speakers/連接揚聲器

Connect the speaker cords to match the color of the SPEAKER jacks of the unit.
將揚聲器導線連接到本機上對應顏色的SPEAKER插孔。

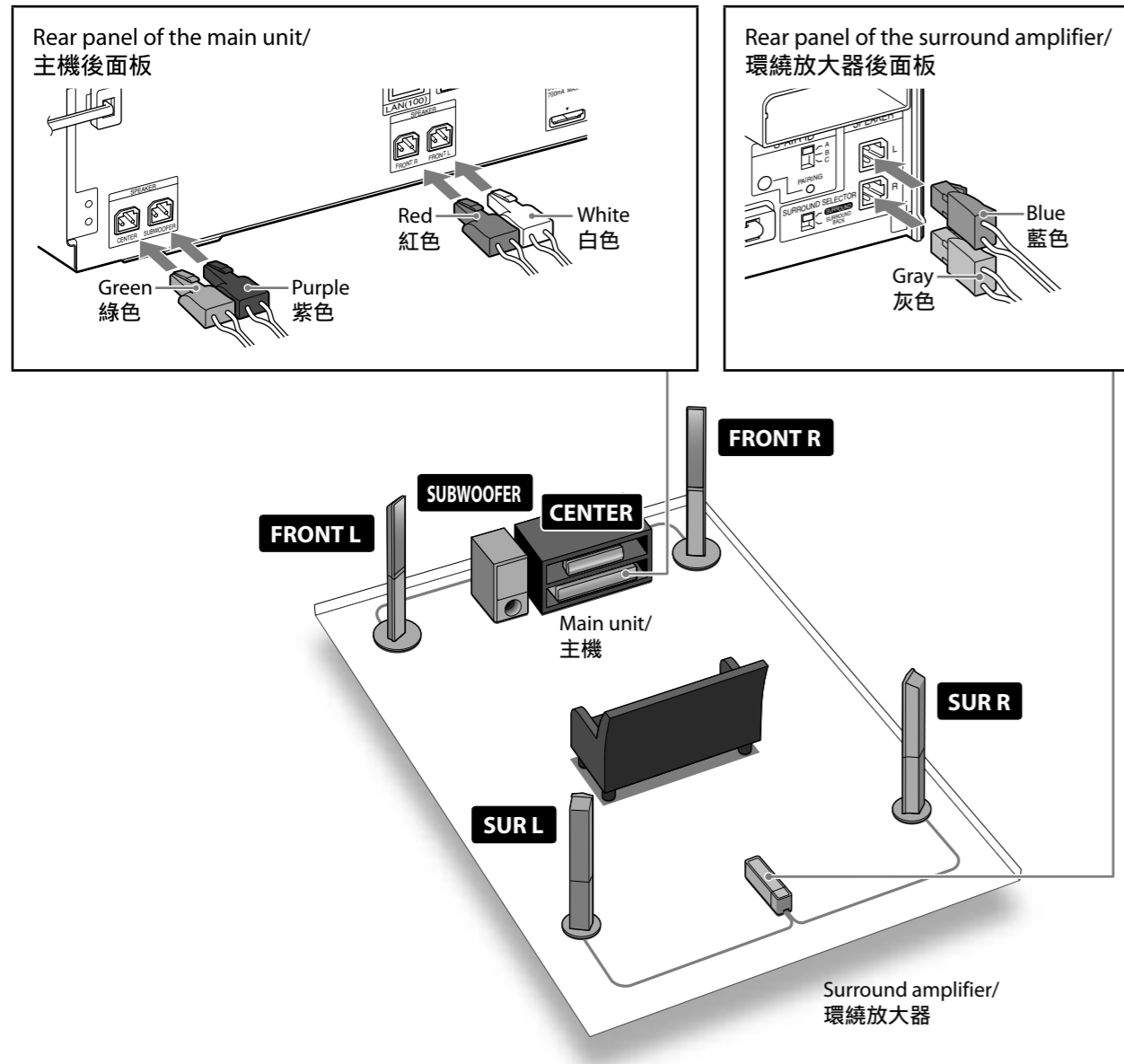

To connect speaker cords to the speaker/將揚聲器導線連接到揚聲器

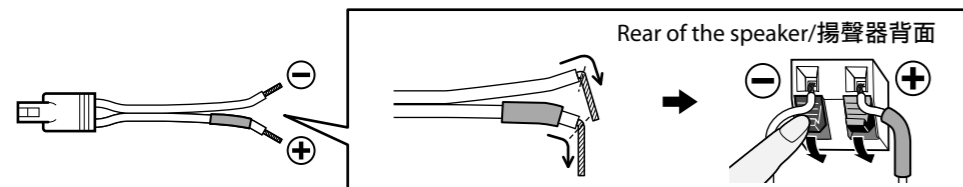

2 Connect your TV/連接電視機

Depending on the jacks on your TV, select the video and audio connection method.
視電視機上的插孔而定，選擇視頻和聲音的連接方法。

Video connection method/視頻連接方法

Method 1/方法 1

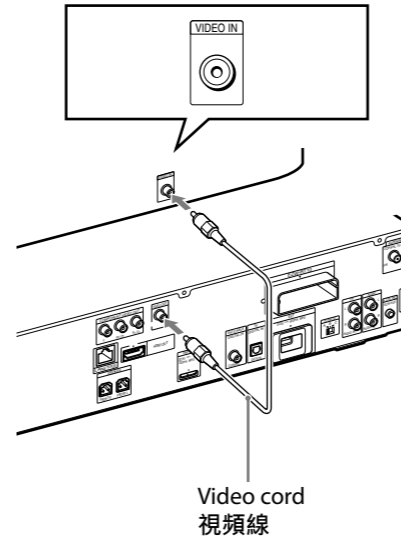

Method 2/方法 2

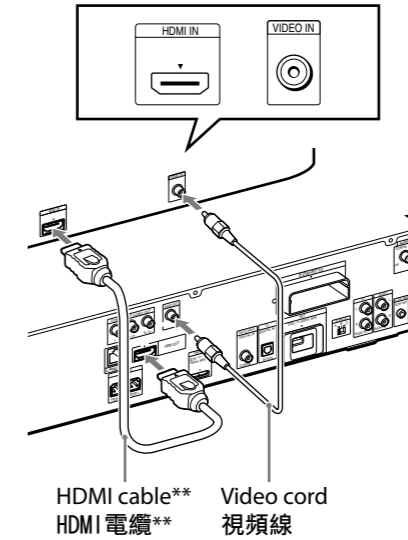

Method 3/方法 3

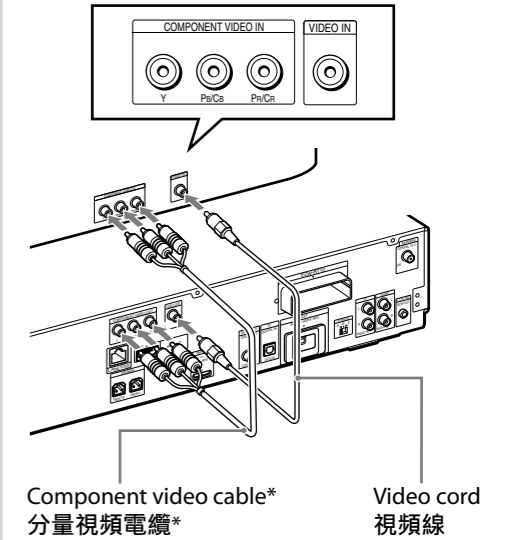

*Not supplied/不提供
**Supplied with Singapore, Indonesian, Malaysian, Hong Kong, Filipino, and Taiwan models only.
**僅新加坡、印尼、馬來西亞、香港、菲律賓和台灣機型提供。

Audio connection method/聲音連接方法

Method 1/方法 1

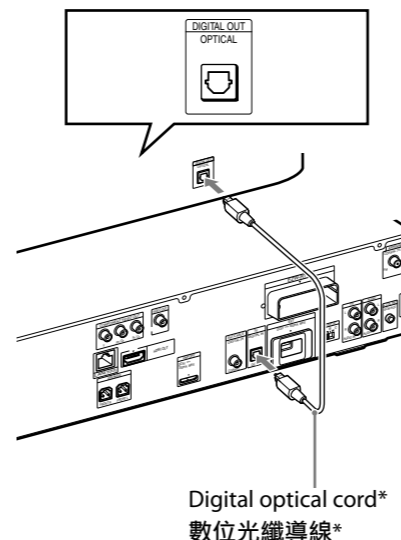

Method 2/方法 2

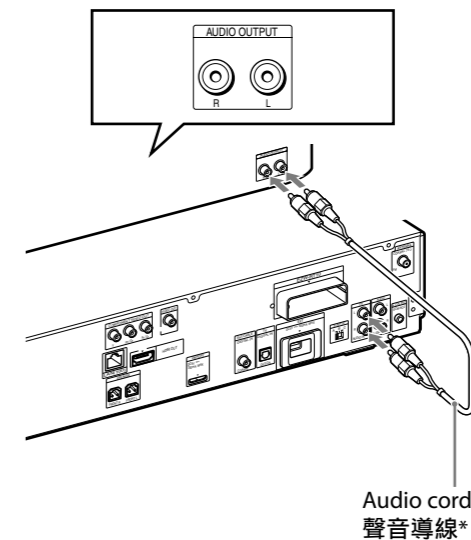

*Not supplied/不提供

3 Enable wireless transmission/ 啟用無線傳輸

- 1. Insert the wireless transceivers into both the main unit and surround amplifier.**
將無線收發器插入主機與環繞放大器。

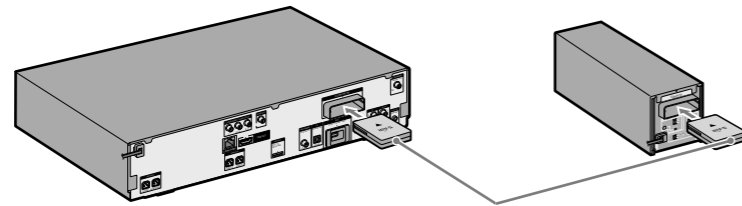

Insert securely until they click.
牢固地插入，直至聽到喀嗒聲。

- 2. Set the S-AIR ID switches to "A."**
將 S-AIR ID 開關設定為 "A"。

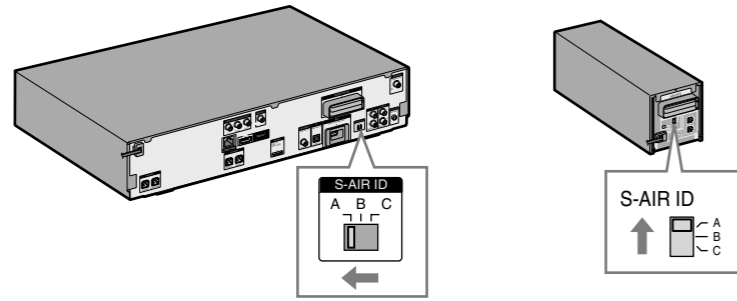

The S-AIR IDs on the main unit and surround amplifier are set to "A" at the factory.
主機與環繞放大器的 S-AIR ID 原廠設定為 "A"。

- 3. Connect the AC power cords (①), and turn on the power (②).**
連接交流電源線 (①)，然後打開電源 (②)。

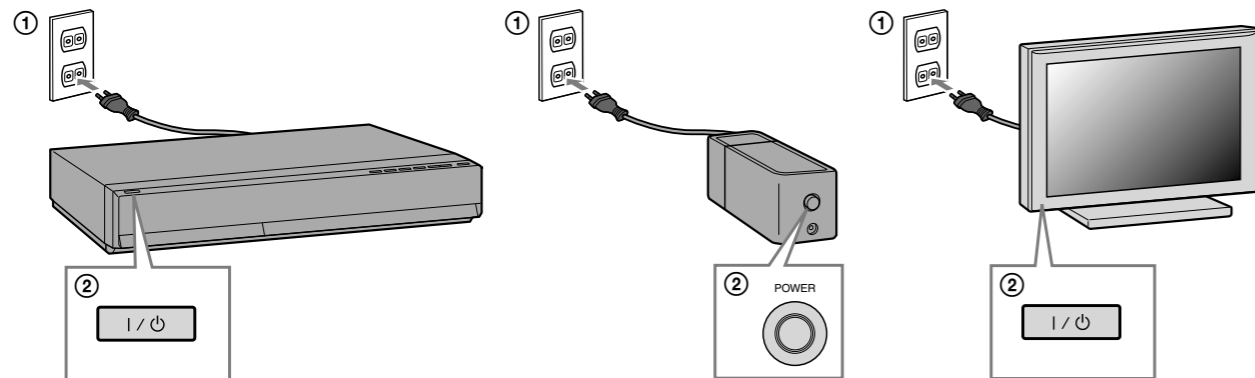

4 Perform "Easy Setup"/ 執行 "簡易設置"

Do not insert a disc before performing the "Easy Setup".
執行 "簡易設置" 前，切勿插入光碟。

- 1. Insert batteries into the remote.**
將電池裝入遙控器。

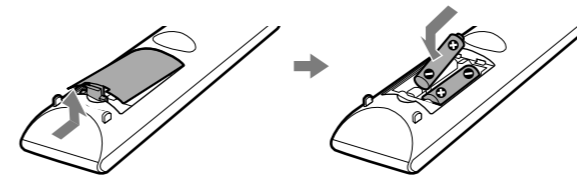

- 2. Switch the input selector on your TV so that system screens like the ones below appear on the TV screen.**

切換電視機上的輸入選擇器，類似以下畫面的系統螢幕會出現在電視機螢幕上。

Starting up/
啟動



"Easy Setup" screen/
"簡易設置" 畫面

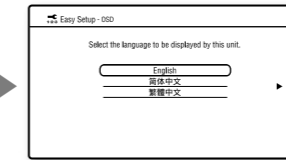

- 3. Perform basic settings by following the on-screen instructions in "Easy Setup" using ←/↑/↓/→ and ⊕.**

使用 ←/↑/↓/→ 和 ⊕，依照 "簡易設置" 中的畫面指示，執行基本設定。

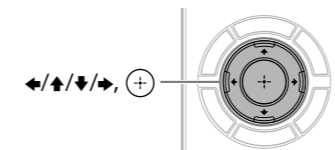

[Easy Setup is now complete.] appears when "Easy Setup" is complete.

"簡易設置" 完成時，會出現 [現在簡易設置已經完成。]。



5 Play a disc/ 播放光碟

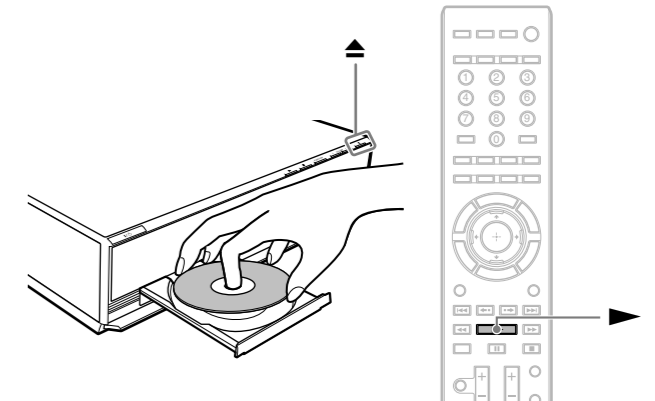

- 1. Press ▲, and place a disc on the tray.**
按 ▲，然後將光碟放入托盤。

- 2. Press ▲ to close the disc tray.**

Playback starts. When playback does not start, press ▶.

按 ▲ 關閉光碟托盤。

開始播放。無法開始播放時，按 ▶。

Enjoying more BD functions

Refer to "Enjoying BonusView/BD-Live" in the Operating Instructions.

欣賞更多 BD 功能

請參閱使用說明書中的 "欣賞 BonusView/BD-Live"。