

# Quick Setup Guide/Guía de ajuste rápido

DAV-TZ510/TZ710

For details, refer to the Operating Instructions.  
Si desea obtener más información, consulte el Manual de instrucciones.

## 1 Connecting the speakers/Conexión de los altavoces

## 2 Connecting your TV/set-top box/Conexión del televisor/descodificador

First, assemble the speakers (refer to the Speaker Installation Guide), and then connect the speaker cords to match the color of the SPEAKERS jacks of the unit.

Depending on the jacks on your TV or set-top box, select the video and audio connection method.  
En función de las tomas de su televisor o decodificador, seleccione el método de conexión de vídeo y audio.

Primero, coloque los altavoces (consulte la Guía de instalación de los altavoces) y, a continuación, conecte los cables de altavoz de modo que coincidan con el color de las tomas SPEAKERS de la unidad.

### Connecting the video to your TV/Conexión del vídeo al televisor

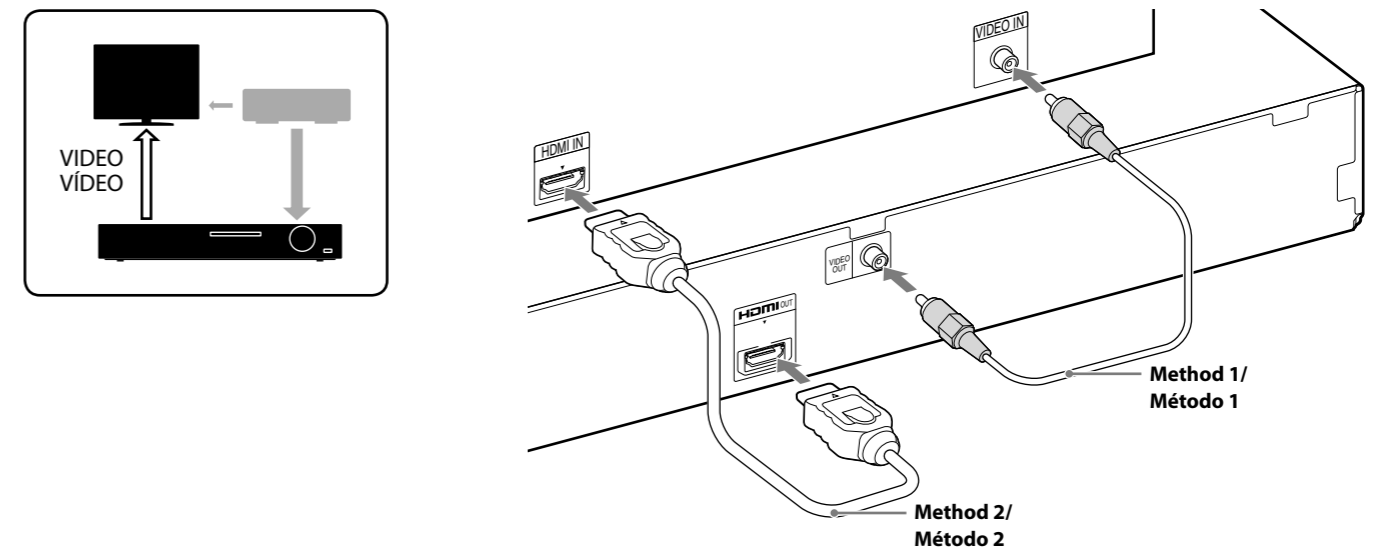
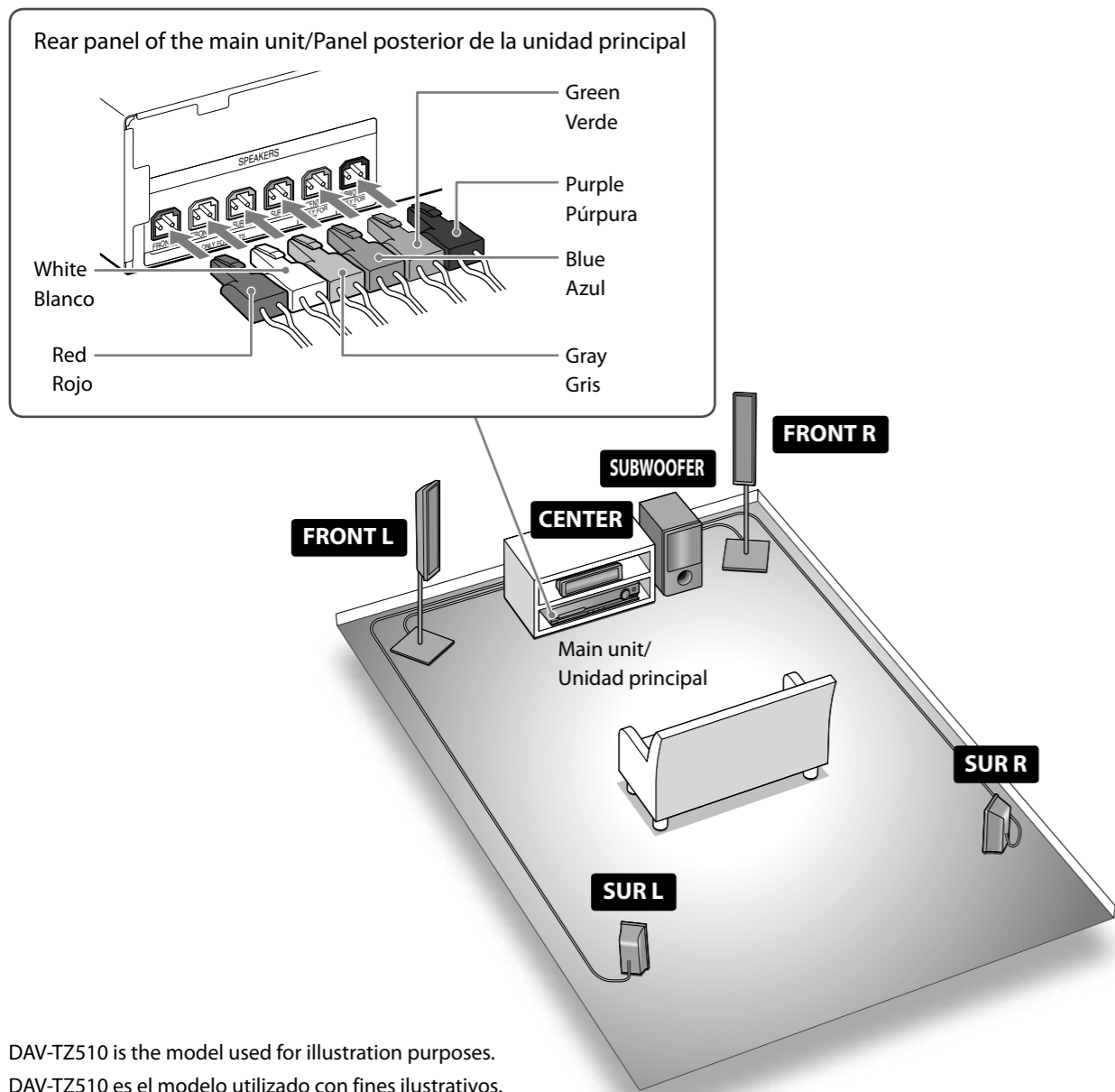

### Connecting the audio from your set-top box/Conexión del audio desde el decodificador

If you do not use a set-top box, refer to "Connecting your TV/set-top box" in the Operating Instructions.  
Si no utiliza un decodificador, consulte "Conexión del televisor/descodificador" en el Manual de instrucciones.

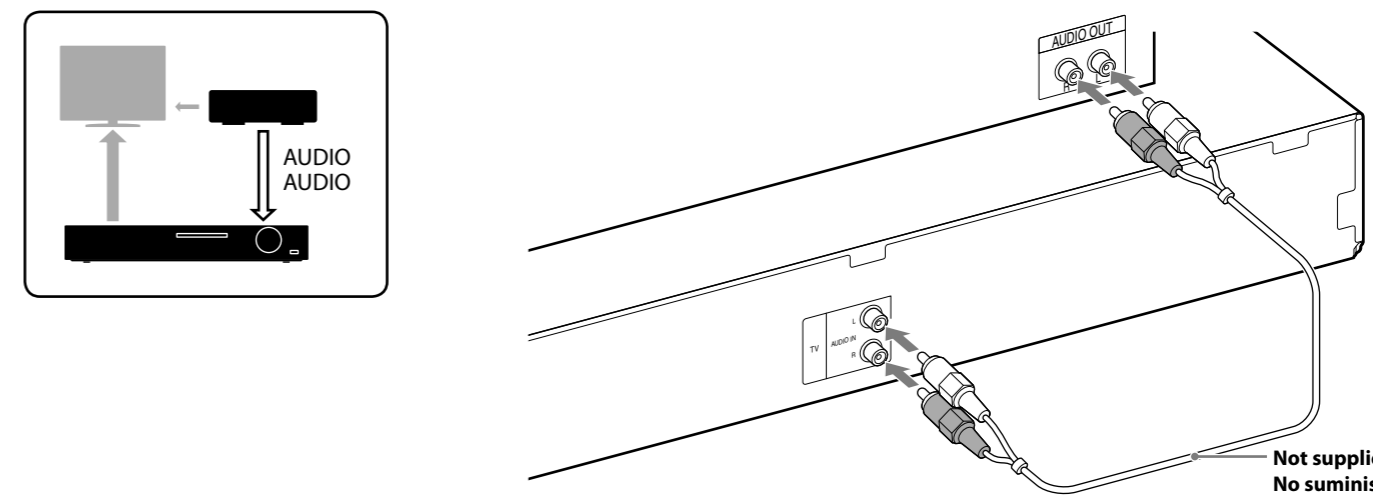

DAV-TZ510 is the model used for illustration purposes.  
DAV-TZ510 es el modelo utilizado con fines ilustrativos.

To connect speaker cords to the speaker/  
Para conectar los cables de altavoz al altavoz

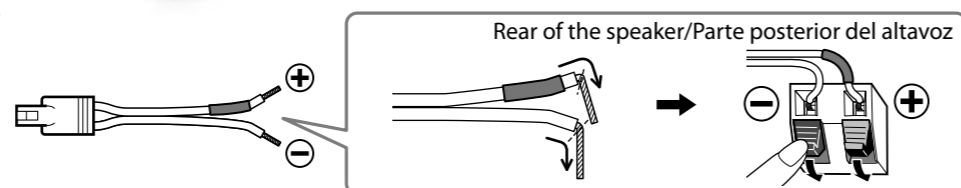

### 3 Performing the Quick Setup/Realización del ajuste rápido

**Note**

Do not insert a disc before performing the Quick Setup.

**Nota**

No inserte ningún disco antes de realizar el ajuste rápido.

#### 1 Connect the AC power cord.

The shape of the wall outlet differs depending on the area.

#### Conecte el cable de alimentación de ca.

La forma de la toma de pared varía en función de la zona.

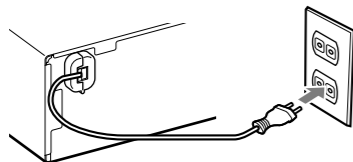

#### 2 Turn on the power of the main unit and TV. Encienda la unidad principal y el televisor.

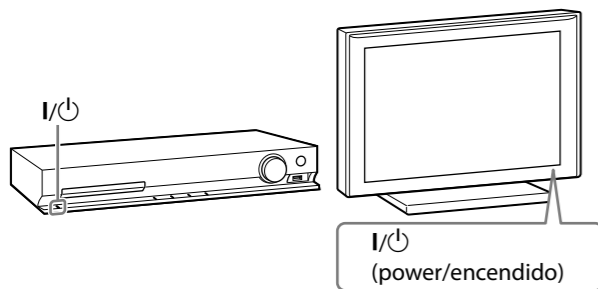

#### 3 Switch the input selector on your TV to display "SONY Home Theatre System."

Cambie el ajuste del selector de entrada del televisor para visualizar "SONY Home Theatre System".

#### 4 Set each following item, using ←/↑/↓/→ and +.

Displayed items vary depending on the area.

Ajuste cada uno de los elementos siguientes mediante ←/↑/↓/→ y +.

Los elementos que aparecen varían en función de la zona.

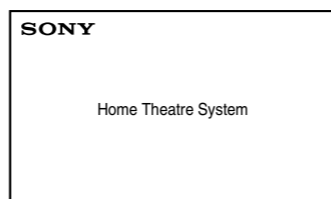
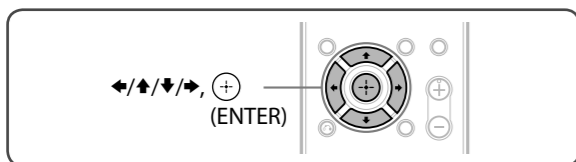

Select an on-screen language.

Seleccione un idioma para las indicaciones en pantalla.

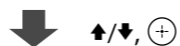
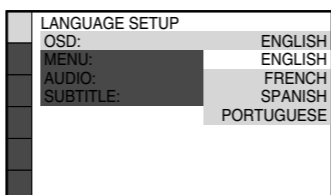

Select the aspect ratio of the connected TV.

Seleccione el formato del televisor conectado.

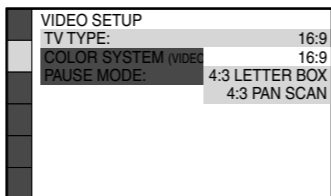

Select [ON] when you connect the main unit and the TV with an HDMI cable.

Seleccione [SI] si conecta la unidad principal y el televisor con un cable HDMI.

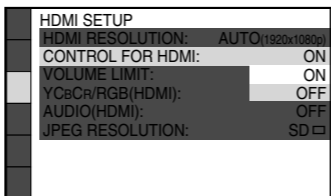

Select the speaker formation.

Seleccione la disposición de los altavoces.

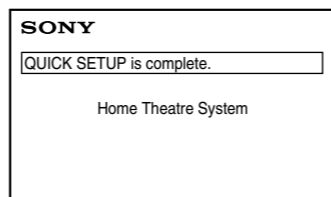
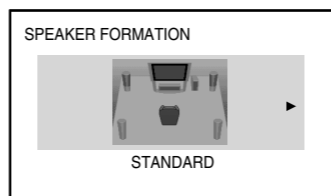

### Listening to TV sound from all speakers/Audición del sonido del televisor a través de todos los altavoces

#### 1 Press TV. Pulse TV.

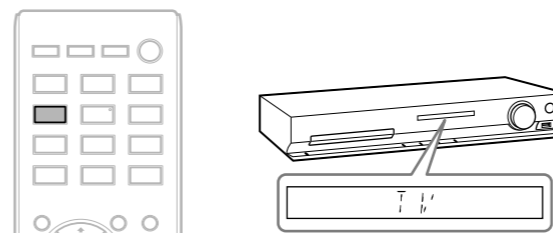

#### 2 Press SYSTEM MENU. Pulse SYSTEM MENU.

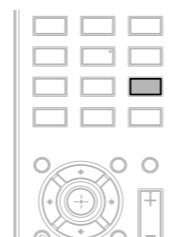

#### 3 Press ↑/↓ to display "SUR. SETTING," then press +.

Pulse ↑/↓ para seleccionar "SUR.SETTING" y, a continuación, pulse +.

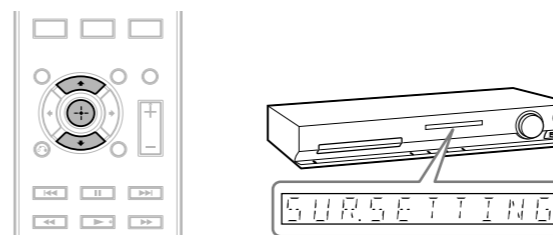

#### 4 Press ↑/↓ to display "PRO LOGIC," then press +.

Pulse ↑/↓ hasta que aparezca "PRO LOGIC" y, a continuación, pulse +.

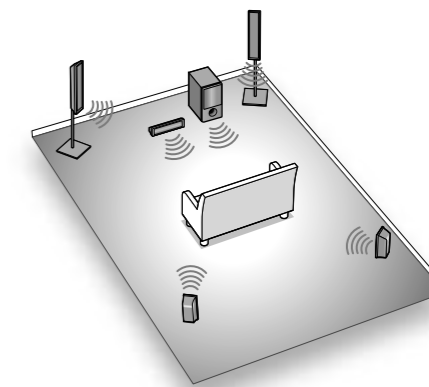
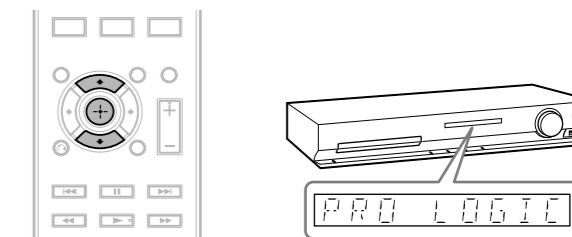

#### 5 Press SYSTEM MENU to exit the menu.

Pulse SYSTEM MENU para salir del menú.

