

Quick Setup Guide/Guia de Instalação Rápida

DAV-TZ230

For details, refer to the Operating Instructions.
Para mais detalhes, consulte o Manual de Instruções.

1 Connecting the speakers/Ligar as colunas

Connect the speaker cords to match the color of the **SPEAKERS** jacks of the unit.
Ligue os cabos das colunas de acordo com a cor das tomadas **SPEAKERS** da unidade.

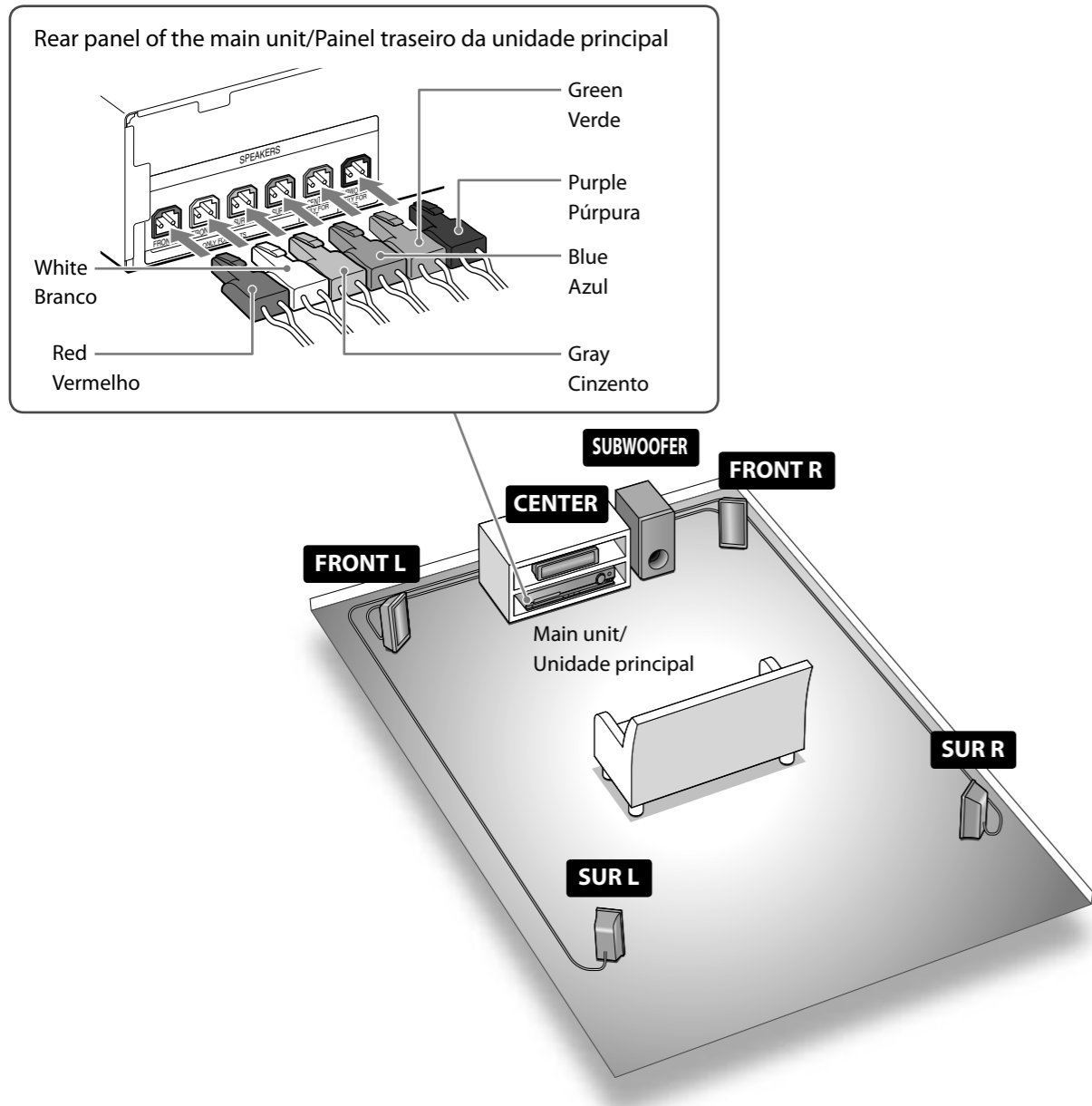

To connect speaker cords to the speaker/
Ligar os cabos das colunas às colunas

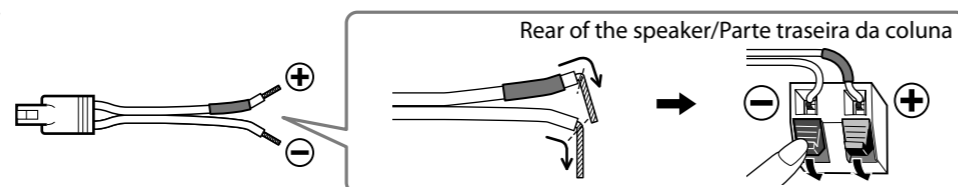

2 Connecting your TV/Ligar o seu televisor

Depending on the jacks on your TV, select one of the connection methods.
Dependendo das tomadas do seu televisor, selecione um dos métodos de ligação.

Method 1: SCART (EURO AV) cable* connection Método 1: ligação do cabo SCART (EURO AV)*

This is the basic connection and sends both video and audio signals.
Esta é a ligação básica, que envia sinais de vídeo e áudio.

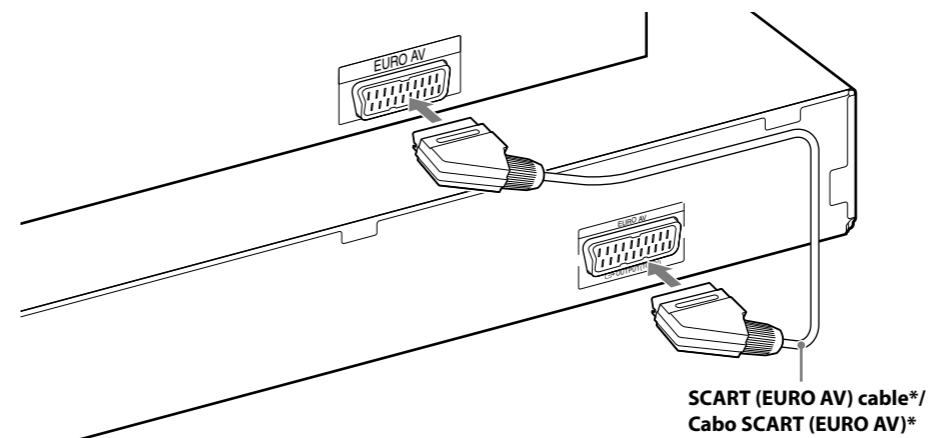

*Not supplied/*Não fornecido

Method 2: HDMI cable* and SCART (EURO AV) cable* connection Método 2: ligação do cabo HDMI* e do cabo SCART (EURO AV)*

Picture quality will be improved compared to Method 1. To listen to TV stereo sound via the system, also connect the SCART (EURO AV) cable*.

A qualidade de imagem será melhorada quando comparado com o Método 1. Para ouvir som estéreo do televisor através do sistema, ligue também o cabo SCART (EURO AV)*.

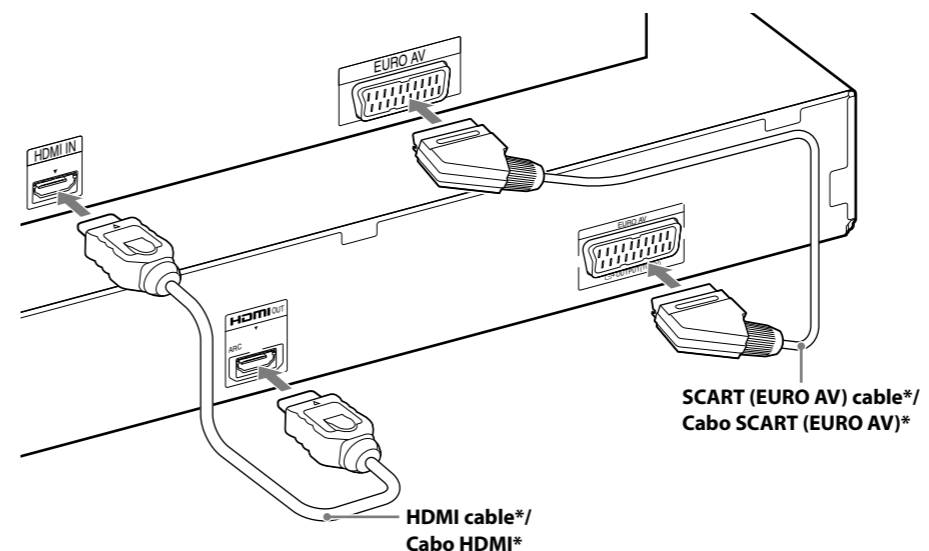

*Not supplied/*Não fornecido

3 Performing the Quick Setup/Realização da Instalação rápida

Note

Do not insert a disc before performing the Quick Setup.

Nota

Não introduza um disco antes de realizar a Instalação Rápida.

1 Connect the AC power cord.

The shape of the wall outlet differs depending on the area.

Ligue o cabo de alimentação CA.

O formato da tomada de parede pode variar consoante a região.

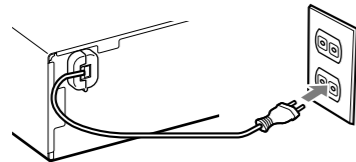

2 Turn on the power of the main unit and TV.

Ligue a alimentação da unidade principal e a televisão.

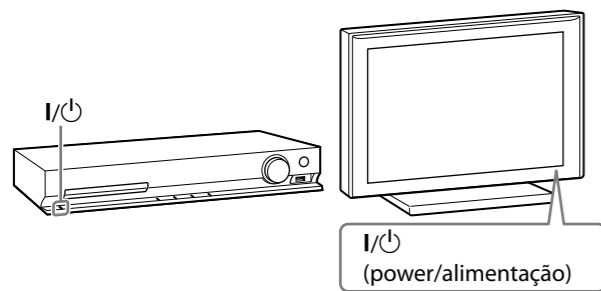

3 Switch the input selector on your TV to display "SONY Home Theatre System."

Regule o selector de entrada do televisor de modo a ser exibido "SONY Home Theatre System."

4 Set each following item, using ←/↑/↓/→ and +.

Displayed items vary depending on the area.

Configure cada um dos seguintes itens utilizando ←/↑/↓/→ e +.

Os itens apresentados variam consoante a região.

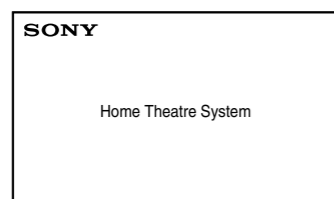
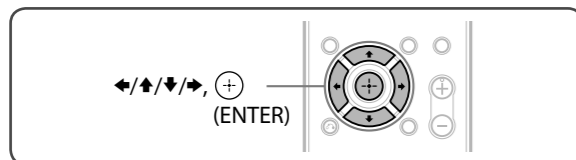

Select an on-screen language.

Seleccione um idioma de visualização no ecrã.

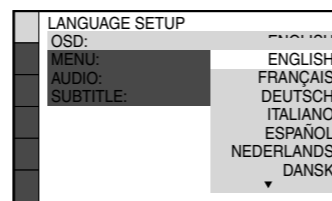

Select the aspect ratio of the connected TV.

Seleccione o formato do televisor ligado.

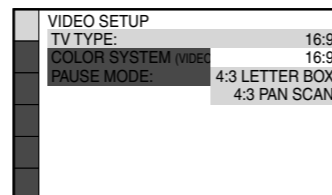

Select the output method for video signals.

Seleccione o método de saída para sinais de vídeo.

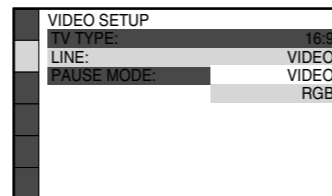

Select [ON] when you connect the main unit and the TV with an HDMI cable.

Seleccione [ACTIVADO] quando ligar a unidade principal e o televisor com um cabo HDMI.

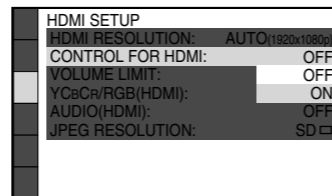

Select the speaker formation.

Seleccione a formação das colunas.

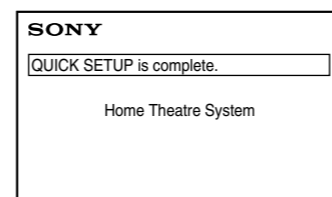
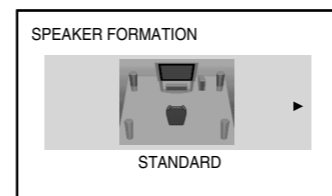

Listening to TV sound from all speakers/Ouvir som do televisor a partir de todas as colunas

1 Press TV. Prima TV.

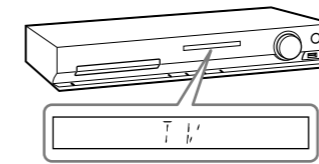
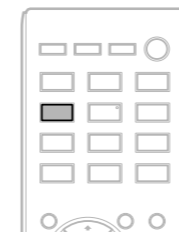

2 Press SYSTEM MENU. Prima SYSTEM MENU.

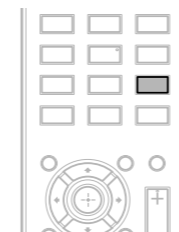

3 Press ↑/↓ to display "SUR.SETTING," then press +.

Prima ↑/↓ para apresentar "SUR.SETTING," e prima +.

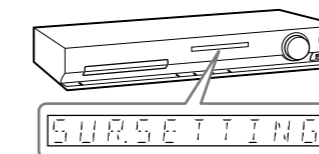
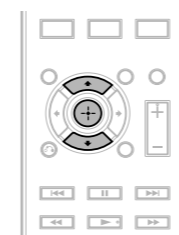

4 Press ↑/↓ to display "PRO LOGIC," then press +.

Prima ↑/↓ para apresentar "PRO LOGIC," e prima +.

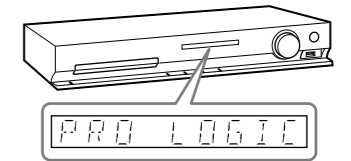
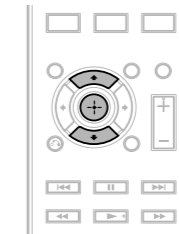

5 Press SYSTEM MENU to exit the menu. Prima SYSTEM MENU para sair do menu.

