

SONY®

KV-21LT1U
KV-14LT1U

Checking the Accessories Supplied

1

Connecting an Indoor Aerial (only for KV-14LT1U)

3

Quick Start Guide

Thank you for purchasing this Sony product.

After following this step by step guide you will be able to:

Insert Batteries into the Remote Control.

Connect the Aerial to your TV.

Select the language of the menu screens.

Tune your TV.

Change the Programme order of the TV channels.

View TV Programmes.

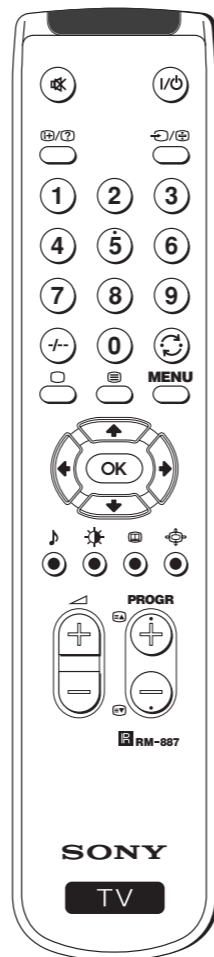

Remote Control RM-887

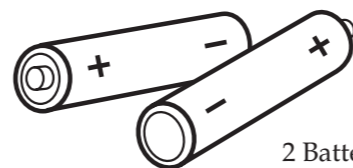

2 Batteries

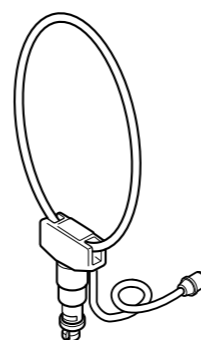

1 Loop aerial (only for KV-14LT1U)

i For a better reception we recommend you connect an external aerial. However, where an external aerial is not available and your local UHF signal is strong you can connect the supplied loop aerial as follows:

- 1 Insert the loop aerial into the opening on top of the set until it clicks.
- 2 Connect the aerial connector to the aerial socket on the rear of the set.
- 3 After turning on the TV, adjust the aerial for optimum reception.



Connecting an Outdoor Aerial and VCR

4

i Connecting cables are not supplied.



or

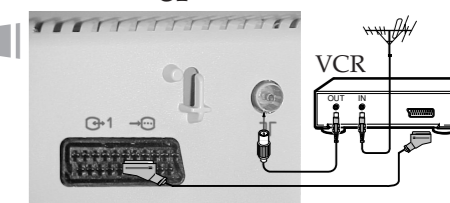

i The Scart lead is optional. If you use this optional connection it can improve the picture and sound quality when using a VCR.

A If you do not use a SCART lead, after automatically tuning the TV refer to the «Manual Programme Preset» option on page 11 step a) of the instruction manual, to tune in the TV to the output of your VCR. Also refer to your VCR instruction manual to find out how to find the output channel of your VCR.

Inserting Batteries into the Remote Control

2

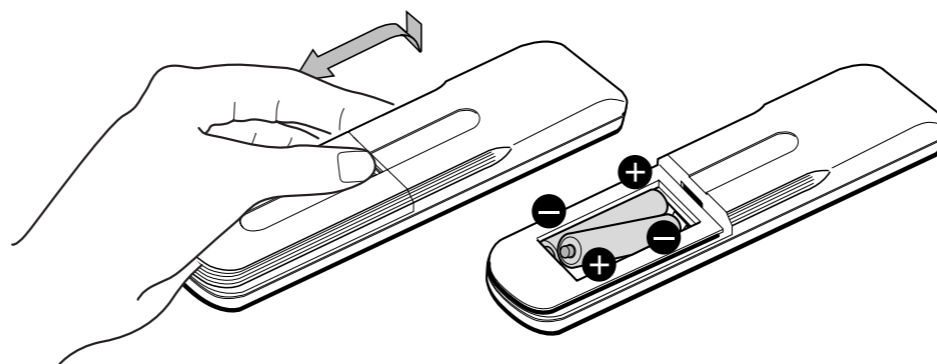

FD Trinitron Colour Television

4-205-741-11 (1)

Switching on the TV

5

Automatically Tuning the TV

You need to tune the TV to receive channels (TV Broadcast). By following the instructions below, this TV automatically searches and stores all available channels for you.

7

Changing the Programme Order of the TV channels

By following the instructions below, you can rearrange the order in which the channels appear on the screen.

8

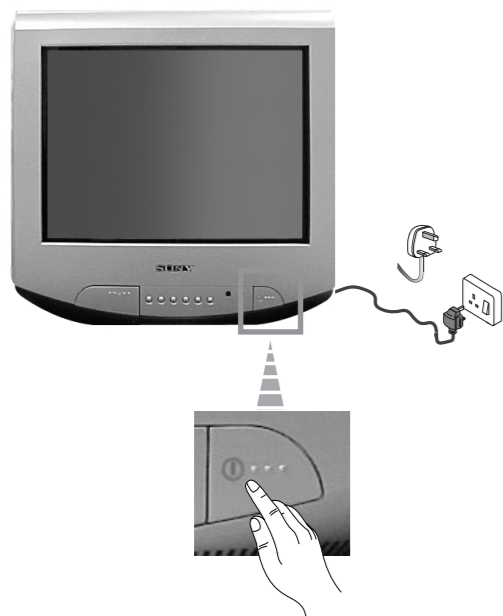

Connect the TV plug to the mains socket (220-240V AC, 50Hz).

Push in the **On/Off** switch on the front of the TV.

Selecting the language of the menu screens

This TV set works with menu screens. By following the instructions below, you can select the desired language of the menu screens.

6

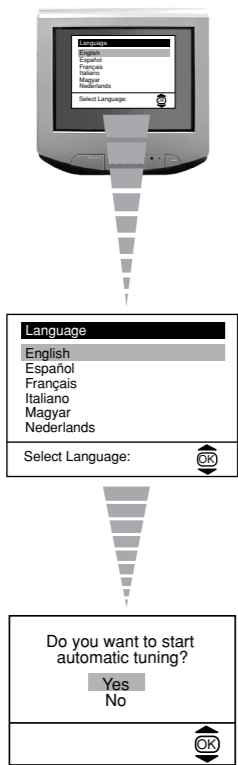
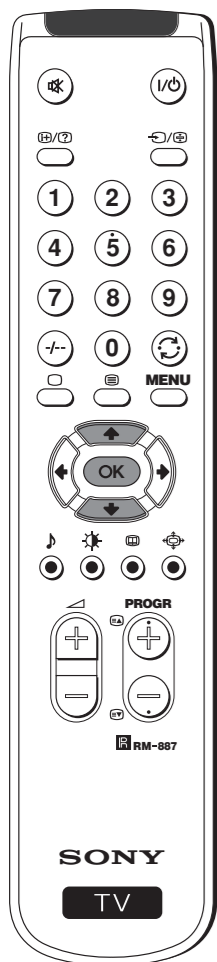

The first time that you switch on your TV, the Language menu appears automatically.

Press the **↓** or **↑** button on the remote control to select the language, then press the **OK** button on the remote control to confirm your selection.

The Automatic Tuning menu appears on the TV screen in the selected language.

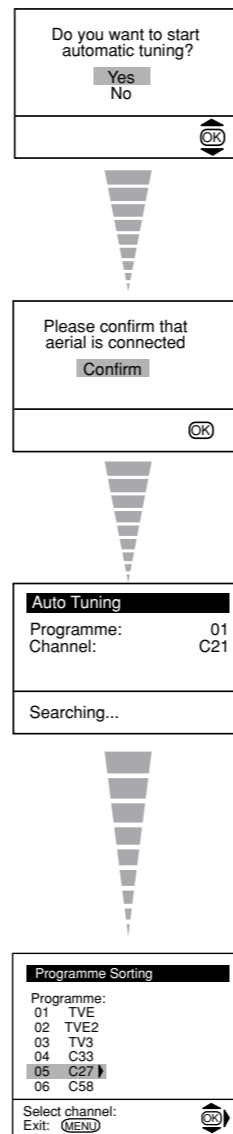
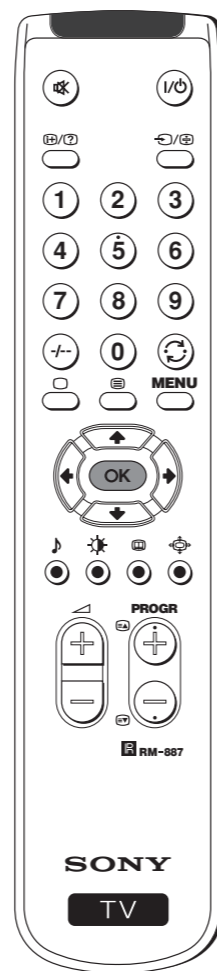

Press the **OK** button on the remote control to select **Yes**.

Confirm that the aerial is connected and then press the **OK** button on the remote control.

The TV starts to automatically search and store all available channels (TV Broadcast) for you.

⚠ This procedure could take some minutes. Please be patient and do not press any button while the automatic tuning is in progress. Otherwise the automatic tuning will not be completed.

When the automatic tuning is finished, the Programme Sorting menu appears on the screen.

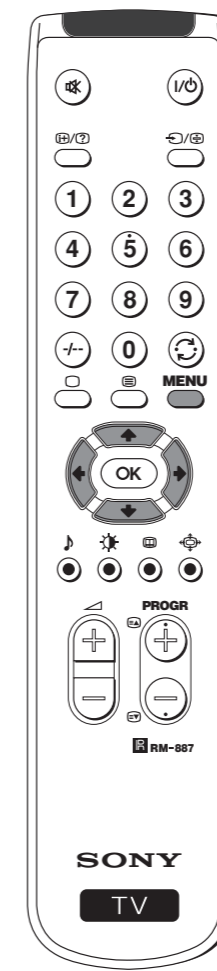

a) If you do not wish to change the channel order:

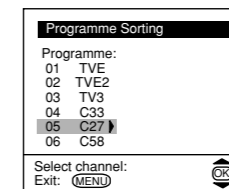

- Press the **MENU** button on the remote control to exit and return to the normal TV screen.

👍 Your TV is now ready for use.

b) If you wish to change the channel order:

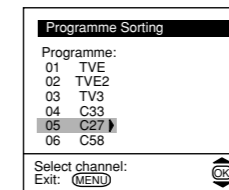

- Press the **↓** or **↑** button on the remote control to select the programme number with the channel (TV Broadcast) you wish to rearrange, then press the **↔** button.

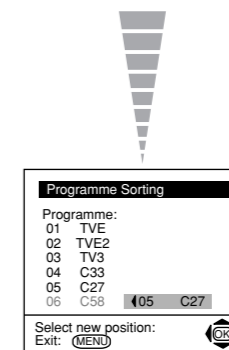

- Press the **↓** or **↑** button on the remote control to select the new programme number position for your selected channel (TV Broadcast), then press the **OK** button.

- Repeat all the above steps if you wish to change the order of the other channels on your TV.

- Press the **MENU** button on the remote control to exit and return to the normal TV screen.

👍 Your TV is now ready for use.

Your television stations are now stored in your television's memory.