

# *Micro Hi-Fi Component System*

---

Operating Instructions



*CMT-SP55MD*

Do not install the appliance in a confined space, such as a bookcase or built-in cabinet.



This appliance is classified as a CLASS 1 LASER product. The CLASS 1 LASER PRODUCT MARKING is located on the rear exterior.

The following caution label is located inside of the unit.



US and foreign patents licensed from Dolby Laboratories.

# Table of Contents

## Getting Started

Step 1: Hooking up the system .....	4
Step 2: Setting the time .....	8

## The CD Player

Playing a CD .....	9
Playing CD tracks in random order	
— Shuffle Play .....	10
Programming CD tracks	
— Programme Play .....	11
Playing CD tracks repeatedly	
— Repeat Play .....	12
Using the CD display .....	13
Labelling a CD — Disc Memo .....	14
Checking Disc Memo information .....	16

## The MD Deck — Play

Playing an MD .....	17
Playing MD tracks in random order	
— Shuffle Play .....	18
Programming MD tracks	
— Programme Play .....	19
Playing MD tracks repeatedly	
— Repeat Play .....	20
Using the MD display .....	21

---

## The MD Deck — Recording

Before you start recording .....	22
Recording a CD on an MD	
— CD-MD Synchro Recording .....	23
Recording your favourite CD tracks on an MD	
— CD-MD Synchro Recording .....	24
Recording your favourite portions on an MD	
— Manual Recording .....	26
Recording from the radio	
— Manual Recording .....	27
Making a space between tracks 3 seconds long	
— Smart Space .....	28
Starting recording with 6 seconds of prestored audio data	
— Time Machine Recording .....	29
Marking track numbers .....	31
Adjusting the recording level .....	32
Monaural recording .....	33

---

## The MD Deck — Editing

Before you start editing .....	35
Labelling an MD — Name Function .....	36
Erasing recordings — Erase Function ....	38
Moving recorded tracks	
— Move Function .....	41
Dividing recorded tracks	
— Divide Function .....	42
Combining recorded tracks	
— Combine Function .....	44
Undoing the last edit	
— Undo Function .....	45

---

## Tuner

Presetting radio stations .....	46
Listening to the radio	
— Preset Tuning .....	48
Labelling the preset stations	
— Station Name .....	49
Using the Radio Data System (RDS)* ....	51

---

## Timer/Other Features

Falling asleep to music	
— Sleep Timer .....	51
Waking up to music	
— Daily Timer .....	52
Timer recording radio programmes .....	54
Adjusting the sound .....	56

---

## Optional Components

Connecting a digital component .....	57
Connecting an analogue component .....	58
Connecting external aerials .....	60

---

## Additional Information

Precautions .....	61
System limitations of MDs .....	63
Troubleshooting .....	64
Self-diagnosis Display .....	67
Messages .....	68
Specifications .....	69
Index .....	71

\* European model only

## Step 1: Hooking up the system

Perform the following procedure **1** to **7** to hook up your system using the supplied cords and accessories.

### Note

Be sure to hook up the system with the mains lead unplugged from the mains. Hooking up the system with the mains lead plugged in may cause the system to malfunction.

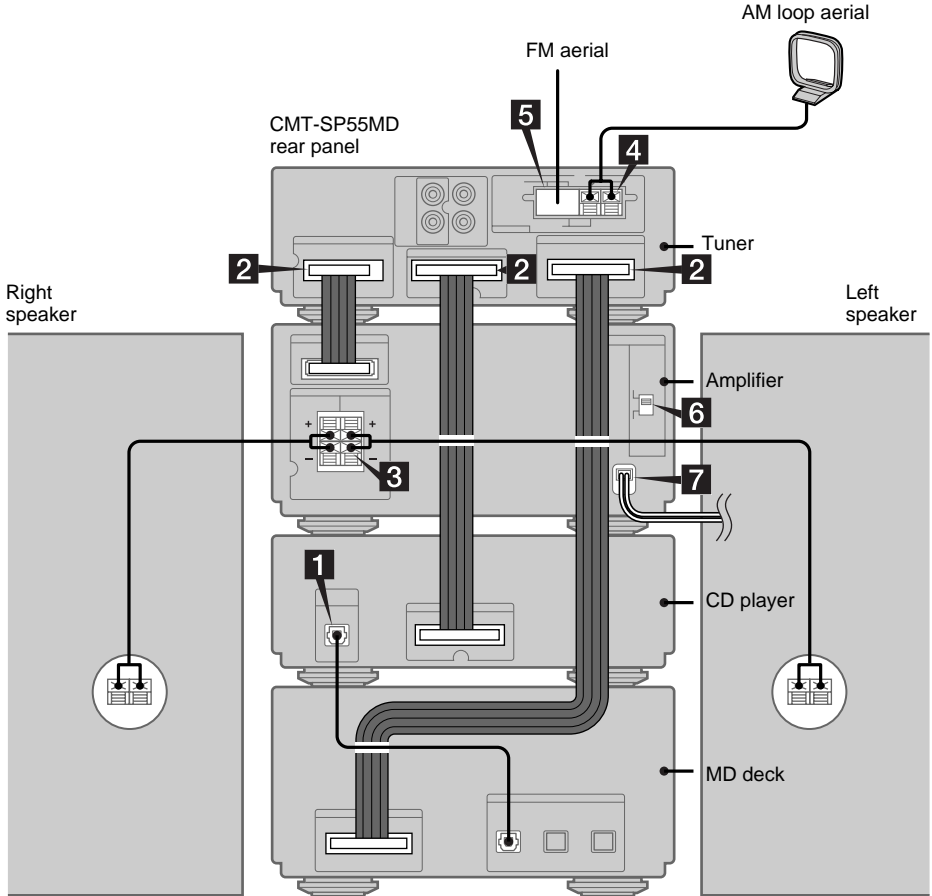

## Preparation

Stack the components vertically in the order shown in the illustration below.

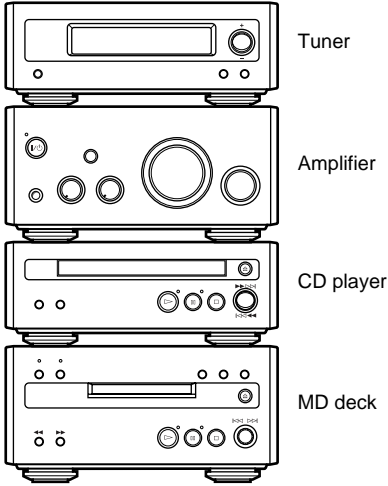

- 1 Connect the supplied digital cable to DIGITAL OPTICAL OUT on the CD player and DIGITAL OPTICAL CD IN 1 on the MD deck.

Take the caps off the connectors, then insert the plugs until they click into place.

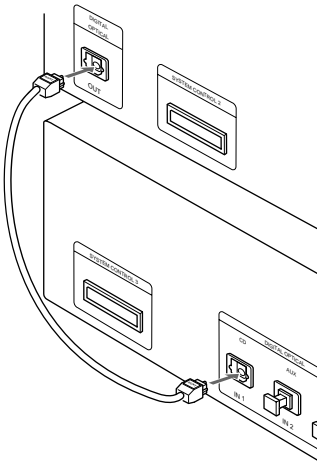

- 2 Connect the system cables to the SYSTEM CONTROL connectors on each component.

### Connect the tuner and amplifier

Connect the system cable on the amplifier to the SYSTEM CONTROL 1 (white) connector on the tuner.

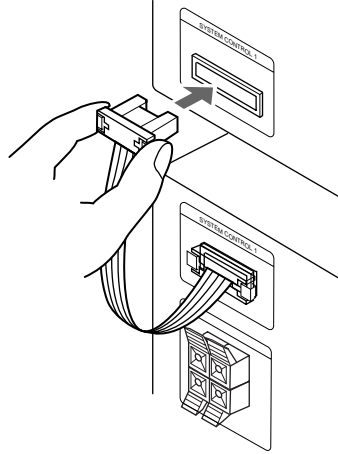

### Connect the tuner and CD player

Connect the supplied system cable to the SYSTEM CONTROL 2 (black) connectors on the tuner and on the CD player.

### Connect the tuner and MD deck

Connect the supplied system cable to the SYSTEM CONTROL 3 (red) connectors on the tuner and on the MD deck.

### Notes

- The system cable is used to send signals and electricity between the components for interlinked operation.  
Be sure to insert the connector horizontally until it clicks into place. Otherwise the system will not operate correctly.
- Keep the system cable away from the aerials to prevent noise or malfunction.

*continued*

## Step 1: Hooking up the system (continued)

### 3 Connect the speakers.

Connect the speaker cords to the SPEAKER terminals on the amplifier and to the terminals on the speakers as shown below.

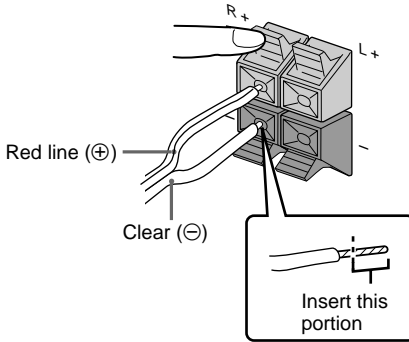

The supplied speakers can be used as either the left or right speakers. Place the speaker connected to the SPEAKER R terminals on the right side, and the speaker connected to the SPEAKER L terminals on the left side of the system.

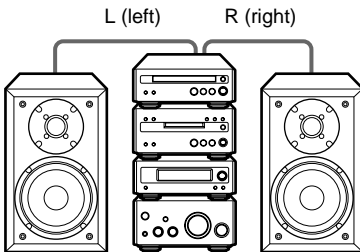

### Notes

- Keep the speaker cords away from the aerials to prevent noise.
- Be sure to connect both left and right speakers. Otherwise, no sound will be produced.

### 4 Connect the AM aerial.

Set up the AM loop aerial, then connect it.

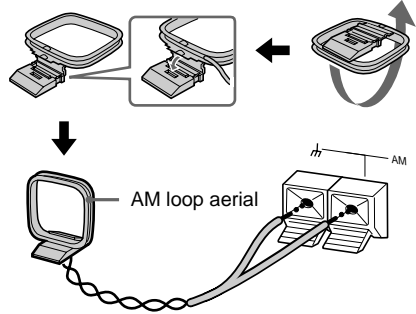

### 5 Connect the FM aerial.

Extend the FM aerial horizontally.

Jack type **(A)**

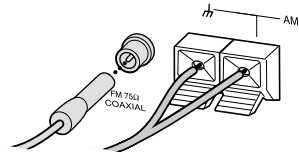

Jack type **(B)**

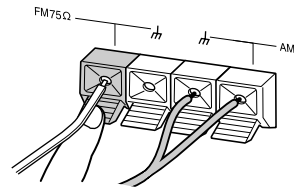

- 6** For models with a voltage selector, set the **VOLTAGE SELECTOR** on the rear of the amplifier to the position of your local mains voltage.

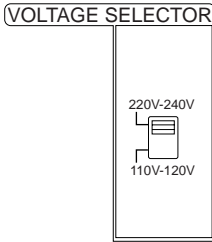

- 7** Connect the mains lead to the mains.

## Arranging the components side by side

Once you have finished the connections, you can rearrange the components as desired.

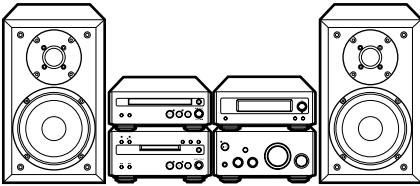

## Inserting two R6 (size AA) batteries into the remote

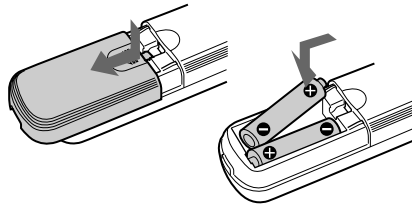

### Tip

With normal use, the batteries should last for about six months. When the remote no longer operates the system, replace both batteries with new ones.

### Notes

- If you do not use the remote for a long period of time, remove the batteries to avoid possible damage from battery leakage.
- Be sure to insert the batteries in correct direction.
- Do not mix a new battery with an old one.
- Do not use different types of batteries together.
- Do not use a battery that is leaking.
- If the battery leaks, clean the battery compartment and replace all the batteries with new ones.

## Adjusting the contrast of the characters in the display

All information for each component appears in the display on the tuner. While holding down **DISPLAY**, press **TUNING +** or **-** to adjust the contrast of the displayed characters. You can finely adjust the contrast in 7 steps from  $-3$  to  $+3$ .

## Adjusting the brightness of the display back light

Press **DISPLAY** in standby mode to light up the display back light. While the display is lit, press **TUNING +** or **-** to adjust the back light brightness.

## Step 2: Setting the time

You must set the time beforehand to use the timer functions.

The clock is on a 24-hour system for the European model, and a 12-hour system for other models.

The 24-hour system is used for illustration purposes.

Set the time before turning on the system.

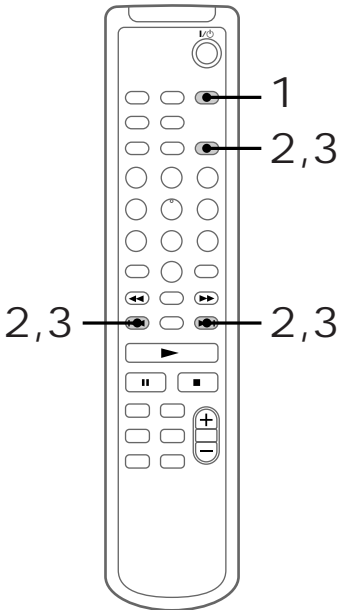

- 1 Press **CLOCK/TIMER SET** while the system is off.

The hour indication flashes.



- 2 Press **◀** or **▶** to set the hour, then press **ENTER/YES**.

The minute indication flashes.



- 3 Press **◀** or **▶** to set the minute, then press **ENTER/YES**.

The clock starts.

If you made a mistake

Start over from step 1.

To change the preset time

You can change the preset time while the system is on.

- 1 Press **CLOCK/TIMER SET**.
- 2 Press **◀** or **▶** repeatedly until "SET CLOCK" appears, then press **ENTER/YES**.
- 3 Repeat steps 2 and 3.

Tips

- The built-in clock shows the time in the display while the system is off. If you press **DISPLAY** at this time, the display back light lights up, making the clock easier to see.
- The upper dot of the colon flashes for the first 30 seconds, and the lower dot flashes for the last 30 seconds of each minute.



## Playing a CD

To turn on the system, press I/⏻ (power).

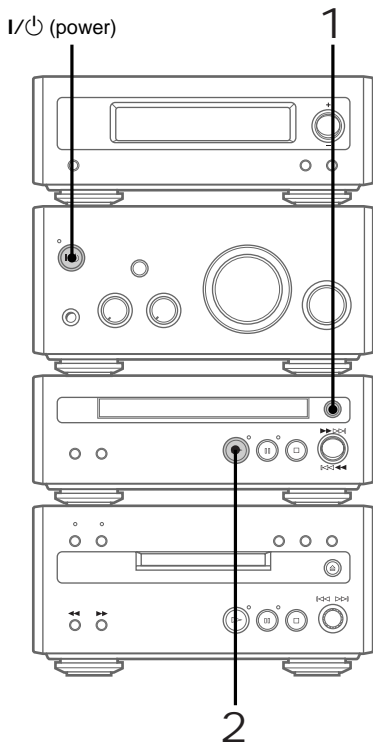

- 1 Press on the CD player and place a CD on the disc tray.

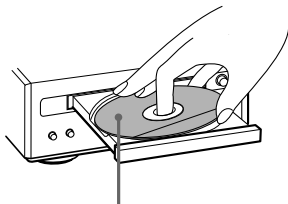

With the label side up.  
When you play a CD single (8 cm CD),  
place it on the inner circle of the tray.

Press again to close the disc tray.

- 2 Press on the CD player.  
Play starts.

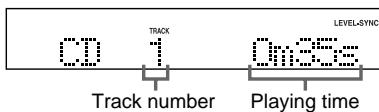

To	Do this
Stop play	Press  on the CD player.
Pause	Press  on the CD player. Press  again or  on the CD player to resume play.
Select a track	Press  or  on the CD player repeatedly.
Find a point in a track	Keep pressing  or  on the CD player during play and release it at the desired point.
Remove the CD	Press  on the CD player.
Adjust the volume	Turn VOLUME.

### Tip

You can switch from another source to the CD player and start playing a CD just by pressing on the CD player (**Automatic Source Selection**).

# Playing CD tracks in random order — Shuffle Play

You can play all the tracks on a CD in random order.

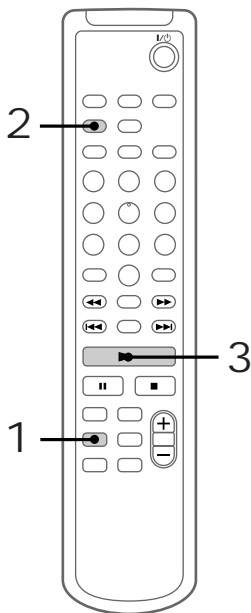

1 Press CD to switch the function to CD.

2 Press PLAY MODE repeatedly until “SHUFFLE” appears.



3 Press ►.  
Shuffle Play starts.

## To cancel Shuffle Play

Press PLAY MODE repeatedly until “SHUFFLE” and “PROGRAM” disappear.

## Tips

- You can start Shuffle Play during normal play by displaying “SHUFFLE”. All the tracks are played in random order.
- To skip a track, press ►►. Press ◀◀ to go back to the beginning of the current track. However, you cannot go back to the previous track.

# Programming CD tracks

## — Programme Play

You can make a programme of up to 25 tracks in the order you want them to be played. You can also make a Synchro Recording of the programme on the MD (see page 24).

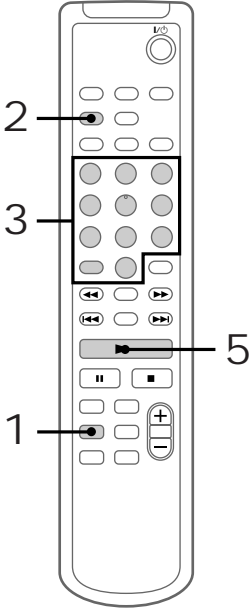

1 Press CD to switch the function to CD.

2 Press PLAY MODE repeatedly until "PROGRAM" appears.

3 Press the track number of the track you want to listen to.

To select track number 11 and higher

Press >10 once and then the number buttons of the track number.

For example, to select track 32, press >10, 3, and 2.

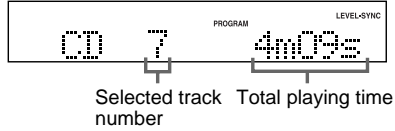

4 To programme additional tracks, repeat step 3.

Each time you programme, the total time of the programme is displayed. You can make a programme of up to 25 tracks.

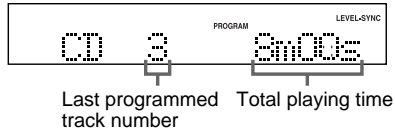

5 Press ►.

All the tracks play in the order you selected.

To	Do this
Cancel Programme and Play	Press ■, then press PLAY MODE repeatedly until "PROGRAM" and "SHUFFLE" disappear.
Add a track to the programme (in stop mode)	Do step 3.
Erase the entire programme	Do steps 1 and 2, then press and hold CLEAR.

*continued*

## Programming CD tracks (continued)

### Tips

- You can select the desired track using ◀◀ or ▶▶ in step 3.  
Press ◀◀ or ▶▶ repeatedly until the desired track number appears, then press ENTER/YES.
- The programme you made remains after Programme Play finishes. To play the same programme again, press ▶.
- “Step Full” appears when you try to programme 26 or more tracks.
- “--m--s” appears when the total CD programme time exceeds 100 minutes.

## Playing CD tracks repeatedly — Repeat Play

You can repeat a CD in normal play, Shuffle Play and Programme Play.

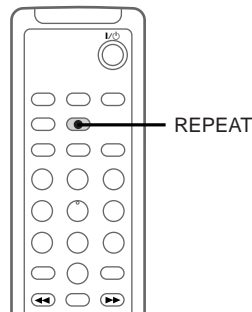

➔ Press REPEAT during play until “REPEAT” or “REPEAT 1” appears.

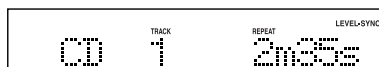

REPEAT: For all the tracks on the CD.

Play mode	Repeat
Normal	All the tracks in order
Shuffle Play (page 10)	All the tracks in random order
Programme Play (page 11)	All the programmed tracks in order

REPEAT 1: For a single track only.

### To cancel Repeat Play

Press REPEAT until “REPEAT” or “REPEAT 1” disappears.

# Using the CD display

You can check the total number of tracks, the total playing time, and the remaining time on the track or on the CD. When a CD TEXT disc is loaded, you can check the information recorded on the disc, such as the titles or artist names.

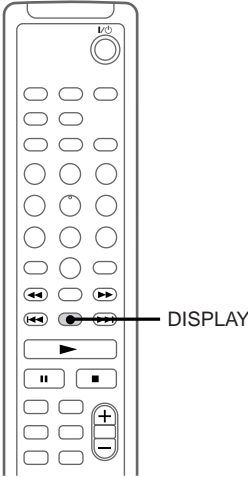

## ➔ Press DISPLAY.

Each time you press the button during normal play or in stop mode, the display changes as follows:

### During normal play

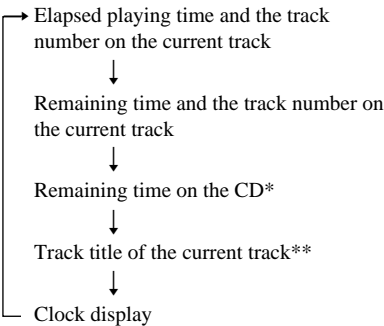

### In stop mode

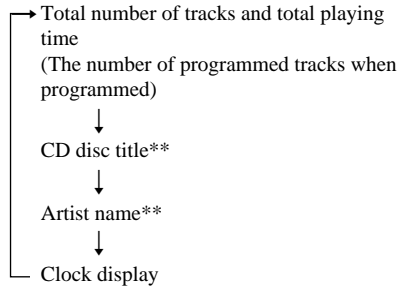

\* The remaining time of the programme appears during Programme Play.

\*\* If no title is labelled or if you select track number 51 or higher of a CD TEXT disc containing 50 or more tracks, nothing appears, then the total number of tracks and the total playing time are displayed.

## Labelling a CD — Disc Memo

You can label up to 50 CDs with titles of up to 20 symbols and characters. Whenever you load a labelled CD, the title appears in the display.

### Notes

- You cannot label a CD for which “CD-TEXT” appears in the display.
- When labelling CDs for the first time, be sure to perform the operations in “Erasing all disc titles stored in the system memory” on page 15 beforehand.**

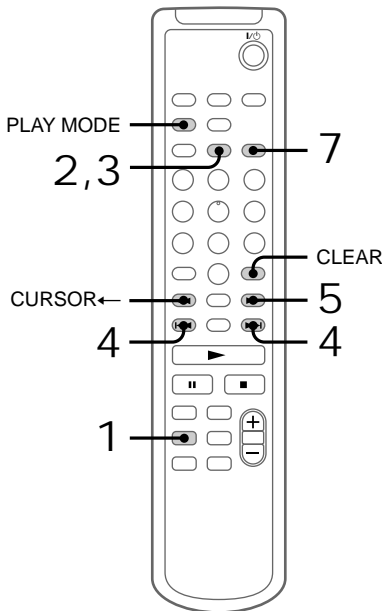

- Press CD to switch the function to CD. Make sure the total number of tracks and the total playing time appear in stop mode. If “SHUFFLE” or “PROGRAM” appears in the display, press PLAY MODE repeatedly until both disappear.

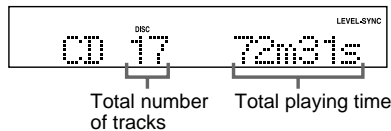

- Press NAME EDIT. The text input screen appears, and the cursor flashes.

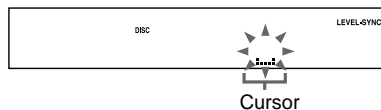

- Press CHARACTER to select the desired type of character. Each time you press the button, the display changes as follows:  
A (Upper cases) → a (Lower cases) → 0 (Numbers) → ! (Symbols) → [Blank space] (Blank space) → A (Upper cases) → ...

- Press ◀◀ or ▶▶ repeatedly to select the desired character.  
To enter a blank space  
Go to step 5 without pressing ◀◀ or ▶▶.  
You cannot enter a space as the first character.

### To enter a symbol

You can use the following 24 symbols.

! " # \$ % & ' ( ) \* + , - . / : ; < = > ? @ \_ `

**5** Press CURSOR→.

The character you selected in step 4 stops flashing and the cursor shifts to the right.

**6** Repeat steps 3 to 5 to complete the entire title.

If you made a mistake

Press CURSOR← or → until the character you want to change flashes, then repeat steps 3 to 5.

To erase a character

Press CURSOR← or → until the character you want to erase flashes, then press CLEAR.

Note

"Name Full" appears when you try to input more than 50 CDs.

**7** Press ENTER/YES to complete the labelling procedure.

"Complete!!" appears and the disc title is stored in the system memory.

To cancel labelling

Press MENU/NO before completing the procedure.

Note

You can label the CD only when the CD player is in stop mode.

**Erasing a disc title**

- 1 Press MENU/NO in stop mode.
- 2 Press ◀◀ or ▶▶ repeatedly until "Name Erase ?" appears, then press ENTER/YES. The disc title flashes. "No Name" appears if no disc title is labelled.
- 3 Press ENTER/YES again. "Complete!!" appears and the disc title is erased.

To cancel erasing

Press MENU/NO before completing the procedure.

**Erasing all disc titles stored in the system memory**

- 1 Press MENU/NO in stop mode.
- 2 Press ◀◀ or ▶▶ repeatedly until "All Erase ?" appears, then press ENTER/YES. "All Erase ???" appears.
- 3 Press ENTER/YES again. "Complete!!" appears and all disc titles are erased.

To cancel erasing

Press MENU/NO before completing the procedure.

## Checking Disc Memo information

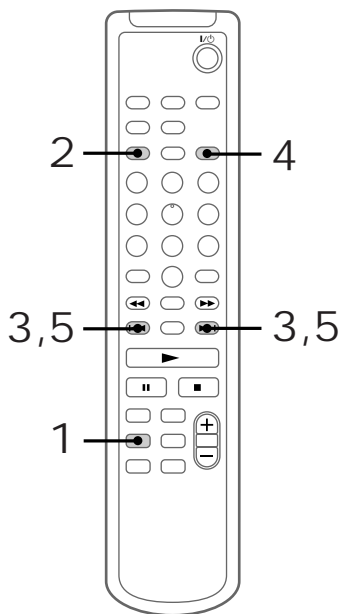

### Checking a disc title

- 1 Press CD to switch the function to CD.
- 2 Press MENU/NO in stop mode.

- 3 Press **◀◀** or **▶▶** repeatedly until “Name Check?” appears.



- 4 Press ENTER/YES.  
Up to 20 characters of the disc title appear scrolling in the display.
- 5 Press **◀◀** or **▶▶** repeatedly to select the disc titles stored in the system memory between 01 and 50.

To cancel checking

Press **■**

Tip

CD TEXT information is copied to MD in some cases.



# Playing an MD

You can play an MD just like a CD.  
To turn on the system, press I/⏻ (power).

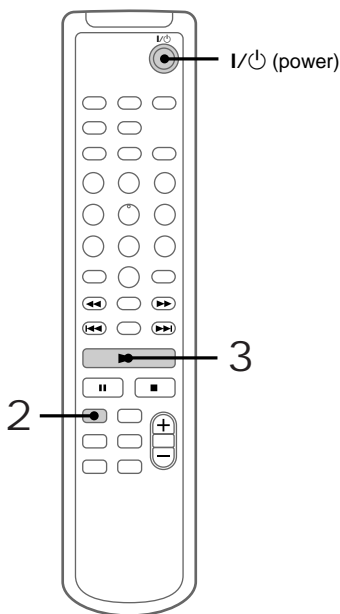

- 1 Insert an MD.  
With the arrow pointing toward the deck.

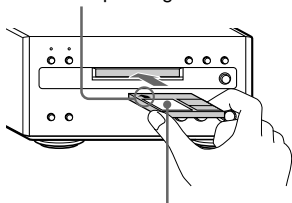

With the label side up, and the shutter on the righthand side.

- 2 Press MD to switch the function to MD.

- 3 Press ▶.  
Play starts.

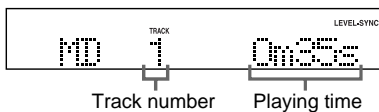

To	Do this
Stop play	Press ■.
Pause	Press   . Press    again or ▶ to resume play.
Select a track	Press ◀◀ or ▶▶.
Find a point in a track	Keep pressing ◀◀ or ▶▶ during play and release it at the desired point.
Remove the MD	Press ⏮ on the MD deck.
Adjust the volume	Press VOLUME + or -.

### Tips

- You can start playing from the desired track in step 3.
  - 1 Press the track number of the track you want to listen to.
    - To select track number 11 and higher**  
Press >10 once and then the number buttons of the track number.  
For example, to select track 32, press >10, 3, and 2.
    - To select track number 100 and higher**  
Press >10 twice and then the number buttons of the track number.
  - 2 Press ▶.
- You can switch from another source to the MD deck and start playing an MD just by pressing ▷ on the MD deck (**Automatic Source Selection**).

### Note

Do not use an MD on which the label sticks out from the edge or on which the label is not positioned correctly. Such labels can cause the MD deck to malfunction.

# Playing MD tracks in random order — Shuffle Play

You can play all the tracks on an MD in random order.

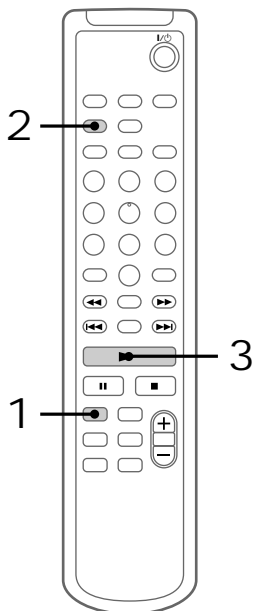

1 Press MD to switch the function to MD.

2 Press PLAY MODE repeatedly until “SHUFFLE” appears in stop mode.

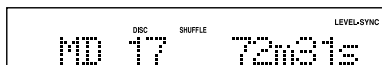

3 Press ►.  
Shuffle Play starts.

## To cancel Shuffle Play

Press ■ to stop Shuffle Play, then press PLAY MODE repeatedly until “SHUFFLE” and “PROGRAM” disappear.

## Tip

To skip a track, press ►►. Press ◀◀ to go back to the beginning of the current track. However, you cannot go back to the previous track.

# Programming MD tracks

## — Programme Play

You can make a programme of up to 25 tracks in the order you want them to be played.

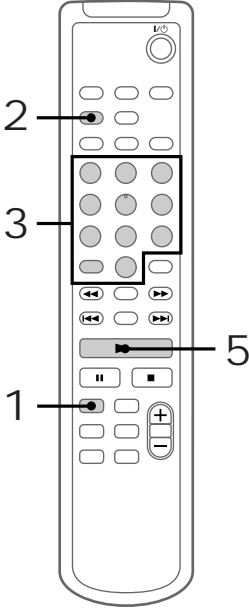

1 Press MD to switch the function to MD.

2 Press PLAY MODE repeatedly until "PROGRAM" appears in stop mode.

3 Press the track number of the track you want to listen to.

To select track number 11 and higher

Press >10 once and then the number buttons of the track number.

For example, to select track 32, press >10, 3, and 2.

To select track number 100 and higher

Press >10 twice and then the number buttons of the track number.

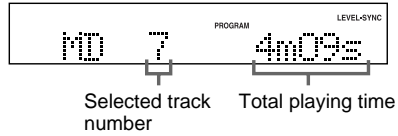

4 To programme additional tracks, repeat step 3.

Each time you programme, the total time of the programme is displayed. You can make a programme of up to 25 tracks.

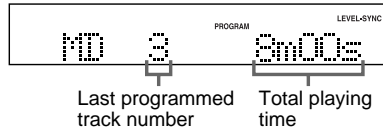

5 Press ►.

All the tracks play in the order you selected.

*continued*

## Programming MD tracks (continued)

To	Do this
Cancel Programme Play	Press ■, then press PLAY MODE repeatedly until “PROGRAM” and “SHUFFLE” disappear.
Add a track to the programme (in stop mode)	Do step 3.
Erase the entire programme	Do steps 1 and 2, then press and hold CLEAR.

### Tips

- You can select the desired track using ◀◀ or ▶▶ in step 3. Press ◀◀ or ▶▶ repeatedly until the desired track number appears, then press ENTER/YES.
- The programme you made remains after Programme Play finishes. To play the same programme again, press ▶.
- “Program Full!!” appears when you try to programme 26 or more tracks.
- “---m--s” appears when the total MD programme time exceeds 199 minutes.

## Playing MD tracks repeatedly — Repeat Play

You can repeat an MD in normal play, Shuffle Play and Programme Play.

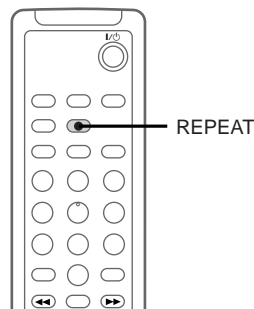

- ➔ Press REPEAT during play until “REPEAT” or “REPEAT 1” appears.

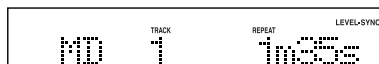

REPEAT: For all the tracks on the MD.

Play mode	Repeat
Normal	All the tracks in order
Shuffle Play (page 18)	All the tracks in random order
Programme Play (page 19)	All the programmed tracks in order

REPEAT 1\*: For a single track only.

\* You cannot repeat a single track during Shuffle Play or Programme Play.

### To cancel Repeat Play

Press REPEAT until “REPEAT” or “REPEAT 1” disappears.

## Using the MD display

You can check the total number of tracks, the total playing time and the remaining time on the MD.

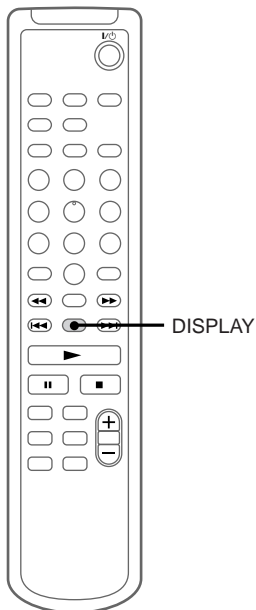

### In stop mode

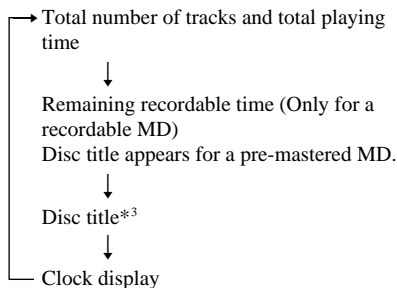

\*3 "No Name" appears if no disc title is labelled.

### Tips

- You can check a track title during play. If you press SCROLL, a track title appears scrolling in the display. Press SCROLL at any point during the scroll display to stop the scrolling. Press SCROLL again to restart the scrolling.
- To label a disc title or a track title, see "Labelling an MD" on page 36.
- "---m--s" appears when the total playing time exceeds 199 minutes.

### ➔ Press DISPLAY.

Each time you press the button during normal play or in stop mode, the display changes as follows:

### During normal play

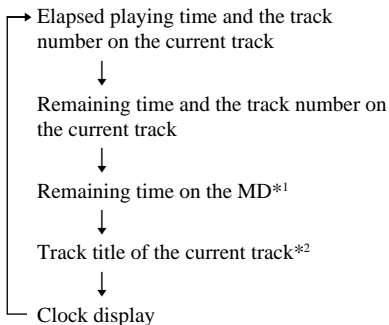

\*1 The remaining time of the programme appears during Programme Play.

\*2 "No Name" appears if no track title is labelled.

## Before you start recording

MDs (MiniDisc) let you digitally record and play music with high quality sound. Another feature of MDs is track marking. The track marking feature lets you quickly locate a specific point or easily edit the recorded tracks. However, depending on the source you record, the recording method and the way the track numbers are recorded differ.

When the source you record from is:

- This system's CD player
  - The MD deck performs digital recording.\*<sup>1</sup>
  - Track numbers are automatically marked as on the original CD.
- Other digital components connected to the DIGITAL OPTICAL AUX IN jack (e.g., a DVD player)
  - The MD deck performs digital recording.\*<sup>1</sup>\*<sup>2</sup>\*<sup>3</sup>
  - Track numbers are marked differently depending on the source you record.
- This system's tuner and other analogue components connected to the SYSTEM CONTROL 3 connector or AUX IN jacks (e.g., the optional tape deck TC-SP55)
  - The MD deck performs analogue recording.
  - A track number is marked at the beginning of a recording, but when you turn on the Level Synchro Recording function (see page 31), track numbers are automatically marked in sync with the level of the input signal.

\*<sup>1</sup>For details on the limitations of digital recording, see page 63.

\*<sup>2</sup>The sound produced from the speakers during recording is the AUX IN jacks audio. When making a digital connection, be sure to also make an analogue connection.

\*<sup>3</sup>If a digital component is not connected to the DIGITAL OPTICAL AUX IN jack using an optical cable, the MD deck performs analogue recording.

## Note on MD track numbers

On an MD, the track numbers (track sequence), track start and end point information, etc., are recorded in the TOC\*<sup>4</sup> area independent of the sound information. You can edit recorded tracks quickly by modifying the TOC information.

\*<sup>4</sup>TOC: Table Of Contents

## After recording

➔ Press  on the MD deck to remove the MD or press I/⏻ (power) to turn off the system.

“TOC” lights up or starts flashing. The TOC is updated and recording is completed.

## Before pulling out the mains lead

MD recording is completed when the MD Table of Contents (TOC) is updated. The TOC is updated when you eject the MD or press I/⏻ to turn off the system. Do not pull out the mains lead before updating the TOC (while “TOC” is lit) or while updating the TOC (while “TOC” is flashing) to ensure a complete recording.

## Protecting a recorded MD

- To protect a recorded MD, slide the tab on the side of the MD to open the slot. In this position, the MD cannot be recorded. To record on the MD, slide the tab to close the slot.

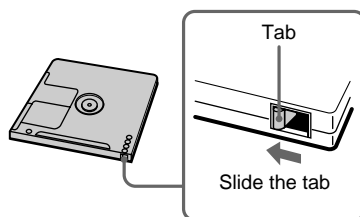

- If the MD is record protected, “C11” and “Protected” appear alternately and the MD cannot be recorded. Remove the MD, then slide the record protection tab to the closed position.

# Recording a CD on an MD — CD-MD Synchro Recording

You can make a digital recording of a CD on an MD, marking track numbers in the same sequence as the original CD.

You can also record a programme of favourite tracks (see page 24).

To turn on the system, press I/⏻ (power).

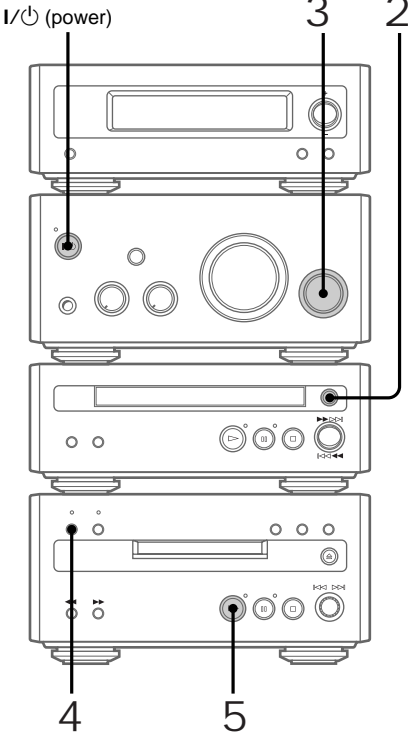

- 1 Insert a recordable MD.  
With the arrow pointing toward the deck.

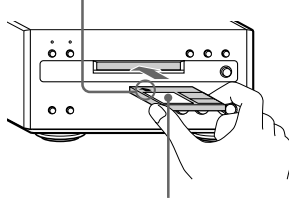

With the label side up, and the shutter on the righthand side.

- 2 Press on the CD player and place a CD on the disc tray.

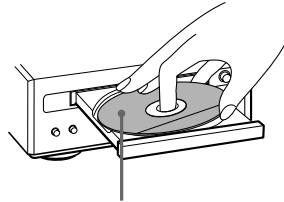

With the label side up.  
When you play a CD single (8 cm CD), place it on the inner circle of the tray.

Press again to close the disc tray.

- 3 Turn FUNCTION until “CD” appears.

- 4 Press CD SYNC REC.

The CD SYNC REC indicator lights up.

The MD deck stands by for recording and the CD player pauses for play.

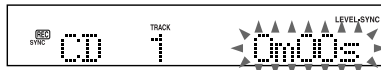

*continued*

## Recording a CD on an MD (continued)

- 5 Press  $\triangleright$  on the MD deck.  
Recording starts.  
When the recording is completed, the CD player and the MD deck stop automatically.

To	Do this
Stop recording	Press $\square$ on the MD deck or CD player.
Remove the MD and CD	Press $\hat{=}$ on the MD deck and CD player in stop mode.

### Tips

- If you use a partially recorded MD, recording starts after the recorded tracks. To erase the recorded contents, see "Erasing recordings" on page 38.
- Depending on the disc, CD TEXT information may also be recorded. If "CD-TEXT" flashes during recording, press NAME EDIT on the remote, and then press ENTER/YES to record the title of the current track. (If "CD-TEXT" is lit, it is automatically recorded.)

### Note

If the MD is record protected, "C11" and "Protected" appear alternately and the MD cannot be recorded. Remove the MD, then slide the record protection tab to the closed position (see page 22).

## Recording your favourite CD tracks on an MD

### — CD-MD Synchro Recording

You can select your favourite CD tracks with the Programme Play feature, then record the programme on an MD using the Synchro Recording feature. If you use a partially recorded MD, recording starts after the recorded tracks.

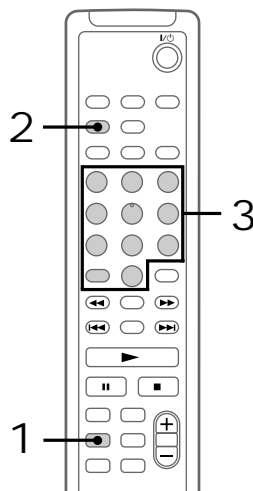
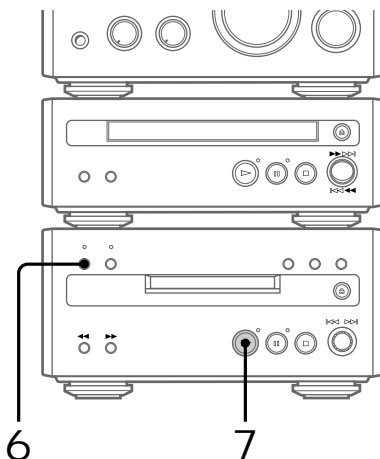



## Selecting the tracks

- 1 Press CD on the remote to switch the function to CD.  
Place a CD.
- 2 Press PLAY MODE on the remote repeatedly until "PROGRAM" appears.
- 3 Press the track number of the track you want to record.

To select track number 11 and higher

Press >10 once and then the number buttons of the track number.

For example, to select track 32, press >10, 3, and 2.

- 4 To programme additional tracks, repeat step 3.  
Each time you programme, the total time of the programme is displayed. You can make a programme of up to 25 tracks.

## Recording on an MD

- 5 Insert a recordable MD.
- 6 Press CD SYNC REC.  
The MD deck stands by for recording and the CD player pauses for play.
- 7 Press  $\triangleright$  on the MD deck.  
CD play and MD recording start.  
When the recording is completed, the CD player stops and the MD deck pauses automatically.

To stop recording

Press  $\square$  on the MD deck.

If the MD becomes full during recording

The MD deck and the CD player automatically stop.

Note

If the MD is record protected, "C11" and "Protected" appear alternately and the MD cannot be recorded. Remove the MD, then slide the record protection tab to the closed position (see page 22).

## Labelling titles during recording

If "CD-TEXT" lights up or flashes during recording, you can record the CD TEXT information onto the MD as follows:

- Automatically during recording  
If you record on an unrecorded or completely erased (see page 39) MD when "CD-TEXT" is lit, the CD TEXT information is automatically recorded.
- Manually during recording  
When "CD-TEXT" flashes, press NAME EDIT on the remote, and then press ENTER/YES to record the title of the current track.

Note

Depending on the disc, the CD TEXT information may not be recorded automatically.

# Recording your favourite portions on an MD

## — Manual Recording

If you use a partially recorded MD, recording starts after the recorded tracks.

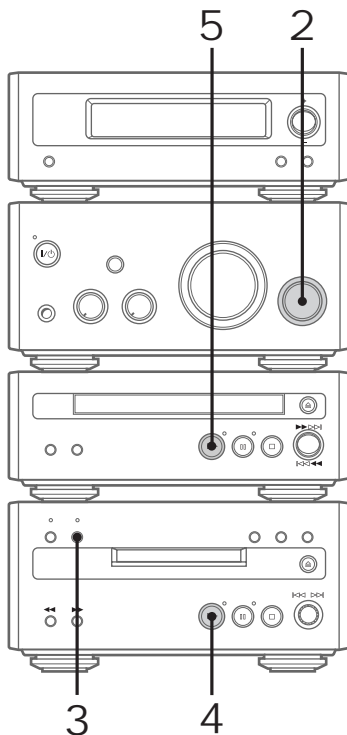

- 1 Insert a recordable MD.
- 2 Turn **FUNCTION** until “CD” appears.
- 3 Press ● **REC**.  
The MD deck stands by for recording.
- 4 Press ▶ on the MD deck.  
Recording starts.
- 5 Press ▶ on the CD player.

### To stop recording

Press □ on the MD deck.

### Tips

- If you turn **FUNCTION** during recording, the MD deck and the CD player automatically stop.
- You can check the remaining recordable time on the MD during recording by pressing **DISPLAY**.

### Note

If the MD is record protected, “C11” and “Protected” appear alternately and the MD cannot be recorded. Remove the MD, then slide the record protection tab to the closed position (see page 22).

# Recording from the radio — Manual Recording

You can make an analogue recording of a radio programme on an MD.

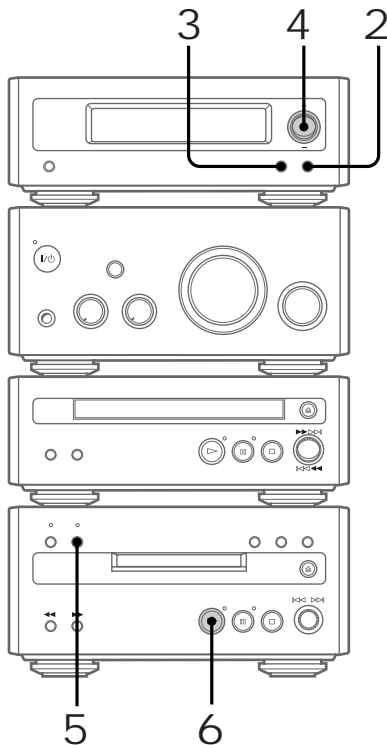

- 1 Insert a recordable MD.
- 2 Press TUNER/BAND repeatedly to select “AM” or “FM”.
- 3 Press TUNING MODE repeatedly until “PRESET” appears.

- 4 Press TUNING + or – to select the desired preset station.  
To preset radio stations, see page 46.



Preset number and frequency (or station name\* or RDS station name\*\*)

- \* The station name appears only if you have labelled the station (see page 49).
- \*\* European model only.

- 5 Press ● REC.  
The ● REC indicator lights up.  
The MD deck stands by for recording.
- 6 Press ▷ on the MD deck.  
Recording starts.

To	Do this
Stop recording	Press □ on the MD deck.
Pause	Press    on the MD deck. Press    again or ▷ on the MD deck to restart recording.
Remove the MD	Press ≡ on the MD deck in stop mode.

## Tips

- If you use a partially recorded MD, recording starts after the recorded tracks. To erase the recorded contents, see “Erasing recordings” on page 38.
- If noise is heard while recording an AM radio programme, move the AM loop aerial to reduce the noise or connect a ground wire to the h terminal (see page 61).

## Note

If the MD is record protected, “C11” and “Protected” appear alternately and the MD cannot be recorded. Remove the MD, then slide the record protection tab to the closed position (see page 22).

# Making a space between tracks 3 seconds long — Smart Space

The Smart Space function lets you make the blank spaces between tracks 3 seconds long automatically while making a digital recording from a CD. For other types of recording, if the Smart Space function is on and there is no sound input for about 3 seconds or more (but less than 30 seconds) while recording, the MD deck replaces this silence with a blank of about 3 seconds and continues recording.

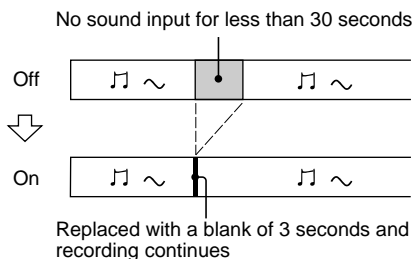

**Auto Cut:** When the Smart Space function is on, if there is no sound input for 30 seconds or more, the MD deck replaces this silence with a blank of about 3 seconds and enters recording pause.

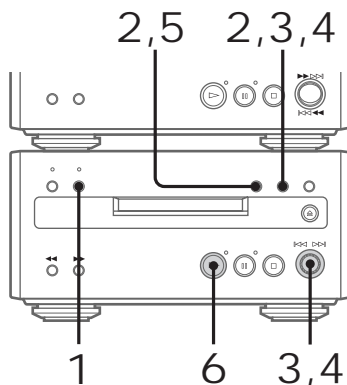
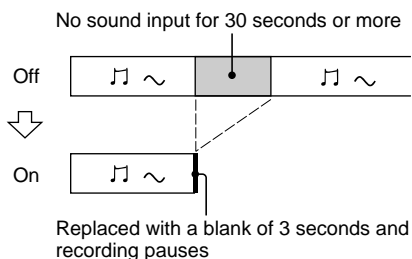

- 1 Press ● REC to stand by for recording.
- 2 Press MENU/NO to display “MD Setup ?”, then press ENTER/YES.
- 3 Turn ◀◀/▶▶ until “MD S.Space OFF” (or “MD S.Space ON”) appears, then press ENTER/YES.
- 4 Turn ◀◀/▶▶ until “MD S.Space ON” appears, then press ENTER/YES.
- 5 Press MENU/NO.

- 6 Press  $\triangleright$  on the MD deck.  
Recording starts.  
If there is an extended silence of less than 30 seconds, "Smart Space" appears, and the MD deck replaces the silence with a blank of about 3 seconds and continues recording.  
If there is no sound input for 30 seconds or more, "Auto Cut" appears, and the MD deck replaces the silence with a blank of about 3 seconds and switches to recording pause.  
Press  $\triangleright$  to restart the recording.

### To stop recording

Press  $\square$  on the MD deck.

### To turn off Smart Space and Auto Cut functions

- 1 Press MENU/NO during recording pause.  
"MD Setup ?" appears, then press ENTER/YES.
- 2 Turn  $\lll / \ggg$  until "MD S.Space ON" appears, then press ENTER/YES.
- 3 Turn  $\lll / \ggg$  until "MD S.Space OFF" appears, then press ENTER/YES.
- 4 Press MENU/NO.

### Tips

- The Smart Space and Auto Cut functions are factory set to on.
- If you turn off the system or disconnect the mains lead, the MD deck will retain the last setting (MD S.Space ON or OFF).

## Starting recording with 6 seconds of prestored audio data

### — Time Machine Recording

When recording from an FM or satellite broadcast, the first few seconds of material are often lost due to the time it takes you to ascertain the contents and press the record button. To prevent the loss of this material, the Time Machine Recording feature constantly stores the most recent audio data in a buffer memory. This lets you record the sound from 6 seconds (12 seconds for monaural recording) before starting recording, as shown in the illustration below:

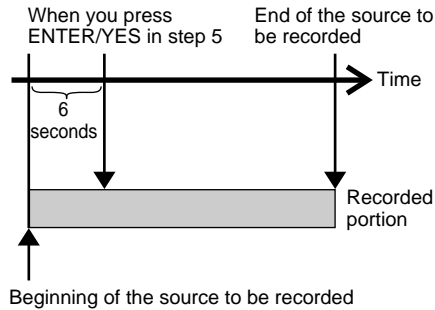

continued

*Starting recording with 6 seconds of prestored audio data (continued)*

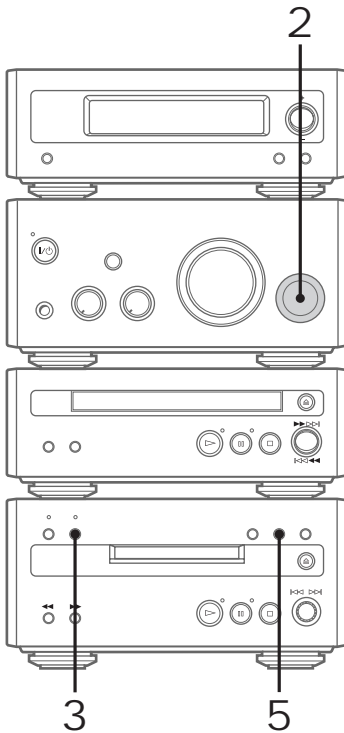

- 
- 1 Insert a recordable MD.

---

  - 2 Turn FUNCTION until the desired sound source (i.e., TUNER) to record appears.

---

  - 3 Press ● REC.  
The MD deck stands by for recording.

- 
- 4 Start playing the desired sound source to record.

- 
- 5 Press ENTER/YES at the desired point to start recording.  
Recording of the sound source starts with the 6 seconds of audio data stored in the buffer memory.  
If you use a partially recorded MD, recording starts after the recorded tracks.

---

To stop Time Machine Recording  
Press □ on the MD deck.

**Note**

The MD deck starts storing audio data when the deck stands by for recording in step 3 and you start playing the source. If less than 6 seconds have passed when you press ENTER/YES, Time Machine Recording starts with less than 6 seconds of audio data.

# Marking track numbers

You can mark track numbers as follows:

- **Automatically during recording**

Track numbers are automatically marked as on the original source during recording from this system's CD player or components connected to the DIGITAL OPTICAL AUX IN jack. Use the Level Synchro Recording function to automatically mark track numbers during recording from this system's tuner, the optional tape deck or components connected to the AUX IN jacks.

- **At any point during recording**

You can mark track numbers while recording any sources.

- **After recording**

Use the Divide function (see page 42).

## Marking track numbers automatically during recording — Level-Synchro Recording

The Level Synchro Recording function is factory set to on, so the track numbers are automatically marked. If "LEVEL-SYNC" does not appear during recording, turn on the Level Synchro Recording as follows. Track numbers are automatically marked when the input signal is continuously below a certain level for more than two seconds and then exceeds that level.

### Note

You can not mark track numbers automatically if the sound source to be recorded is noisy.

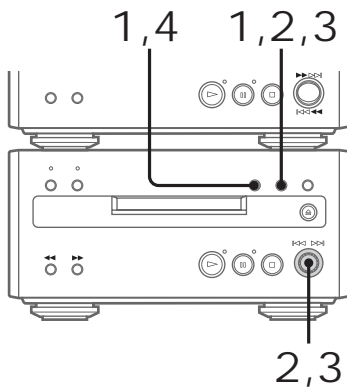

- 1 Press MENU/NO during recording pause to display "MD Setup ?", then press ENTER/YES.
- 2 Turn  $\lll/\ggg$  until "MD T.Mark Off" (or "MD T.Mark LSync") appears, then press ENTER/YES.
- 3 Turn  $\lll/\ggg$  until "MD T.Mark LSync" appears, then press ENTER/YES. "LEVEL-SYNC" lights up.
- 4 Press MENU/NO.

## Cancelling automatic track marking

- 1 Press MENU/NO during recording pause. "MD Setup ?" appears, then press ENTER/YES.
- 2 Turn  $\lll/\ggg$  until "MD T.Mark LSync" appears, then press ENTER/YES.
- 3 Turn  $\lll/\ggg$  until "MD T.Mark Off" appears, then press ENTER/YES. "LEVEL-SYNC" disappears.
- 4 Press MENU/NO.

When "LEVEL-SYNC" is off, a track number is marked only at the beginning of each recording.

continued

## Marking track numbers (continued)

### Marking track numbers at a specific point during recording — Track Mark

You can mark track numbers at any time during recording, regardless of the type of sound source.

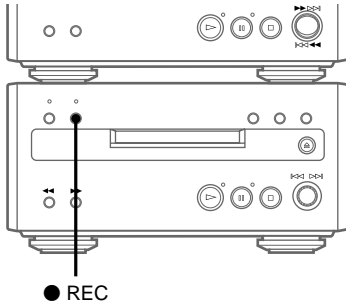

- ➔ Press ● REC during recording at the point you want to add a track mark. The tracks following the added one are renumbered.

## Adjusting the recording level

When recording on an MD, you can adjust the recording level to the desired volume. You can adjust the recording level not only when making an analogue recording, but also when making a digital recording from a CD, etc.

Once adjusted, the recording level is maintained until you adjust it again.

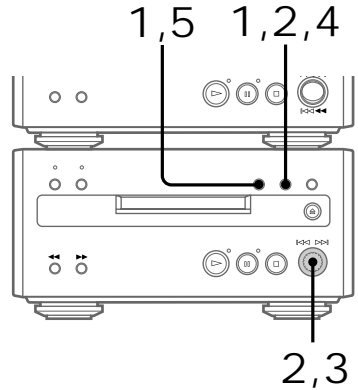

- 1 Press MENU/NO during recording pause to display “MD Setup ?”, then press ENTER/YES.
- 2 Turn ◀◀/▶▶ until “Level Adjust” appears, then press ENTER/YES.



- 
- 3 Turn **⏪/⏩** to adjust the recording level.

The sound source and recording level are displayed. The recording level can be adjusted from -12 to +12. While monitoring the sound, adjust to the optimum level while making sure that “OVER” does not appear in the display at the loudest portion.

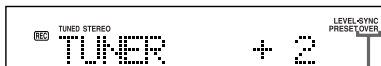

Adjust the level so that “OVER” does not appear

- 
- 4 Press **ENTER/YES**.

- 
- 5 Press **MENU/NO**.
- 

#### Notes

- If you adjust the recording level during recording such as part-way through a track, the recorded volume changes at the point where the adjustment was performed.
- If “OVER” appears in the display when the recording level is between -12 and 0, change the audio input level and reduce the input sound (see page 59).

---

## Monaural recording

Stereo signals such as an FM stereo broadcast can be converted to monaural format and recorded. When recording in monaural format, the MD recording time is approximately twice the normal recording (stereo recording) time (i.e., 120 minutes of monaural audio can be recorded on a 60-minute MD).

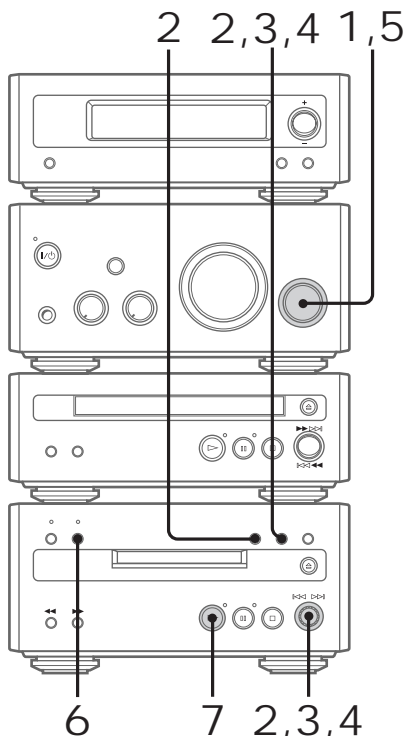

- 
- 1 Turn **FUNCTION** until “MD” appears.
- 
- 2 Press **MENU/NO** in stop mode to display “MD Edit Menu”, and turn **⏪/⏩** until “MD Setup ?” appears. Then press **ENTER/YES**.

*continued*

## Monaural recording (continued)

---

3 Turn  $\llcorner/\triangleright$  until “MD Stereo Rec” (or “MD Mono Rec”) appears, then press ENTER/YES.

---

4 Turn  $\llcorner/\triangleright$  until “MD Mono Rec” appears, then press ENTER/YES.  
“MONO” lights up.

---

5 Turn FUNCTION to select the desired sound source (e.g., TUNER) to record.

---

6 Press ● REC.  
The MD deck stands by for recording.

---

7 Press  $\triangleright$  on the MD deck.  
Recording starts.  
The sound source is heard as is (e.g., stereo sound when recording a stereo broadcast) from the speakers.

---

### To stop recording

Press □ on the MD deck.

### To return to stereo recording

- 1 Press MENU/NO in stop mode.  
Turn  $\llcorner/\triangleright$  until “MD Setup ?” appears, then press ENTER/YES.
- 2 Turn  $\llcorner/\triangleright$  until “MD Mono Rec” appears, then press ENTER/YES.
- 3 Turn  $\llcorner/\triangleright$  until “MD Stereo Rec” appears, then press ENTER/YES.  
The system switches back to stereo recording, and “MONO” lights off.
- 4 Press MENU/NO.

### Tip

The meaning of “MONO” on the left in the display changes as follows according to the MD playback or recording mode.

While the MD is in stop mode, during recording or recording pause, or while ejecting the MD  
→ Indicates that monaural recording is set.

During MD play or playing pause or while selecting a track

→ Indicates that the track being played back or the selected track is recorded in monaural format.

## Before you start editing

You can edit the recorded tracks on an MD. By using the editing functions, you can create a new sequence to the recorded MD.

### Editing functions

- **Name — Labelling MDs (page 36)**

Use this function to label discs and tracks. You can use upper case, lower case, numbers, and symbols for the titles.

- **Erase — Erasing recordings (page 38)**

Use this function to erase a single track one by one, all the tracks at once, or a portion of a track.

- **Move — Changing the order of tracks (page 41)**

Use this function to change the track numbering.

- **Divide — Adding track numbers (page 42)**

Use this function to add track numbers. This lets you locate your favourite phrases quickly.

- **Combine — Combining recorded tracks (page 44)**

By using this function, two tracks are combined to a single track. You can combine the tracks which are not numerically consecutive, i.e. the track 1 and track 4, etc.

- **Undo — Cancelling the last edit (page 45)**

Use this function to cancel the last edit and restore the contents of the MD to the condition before the edit.

### Before editing

You can edit an MD only when:

- The MD is recordable.
- The MD play mode is normal play.

Check the following, before editing.

#### 1 Check the tab of the MD to be edited.



If the MD is protected, “C11” and “Protected” appear alternately and the MD cannot be edited.

Slide the tab to close the slot.

#### 2 Press PLAY MODE repeatedly in stop mode until both “PROGRAM” and “SHUFFLE” disappear.

You can edit the MD only in normal play mode. You cannot edit the MD in Shuffle or Programme Play mode.

### After editing

- ➔ Press  on the MD deck to remove the MD or press  (power) to turn off the system.

“TOC” lights up or starts flashing. The TOC is updated and editing is completed.

Before pulling out the mains lead MD editing is completed when the MD Table of Contents (TOC) is updated. The TOC is updated when you eject the MD or press  to turn off the system. Do not pull out the mains lead before updating the TOC (while “TOC” is lit) or while updating the TOC (while “TOC” is flashing) to ensure a complete editing.

# Labelling an MD

## — Name Function

You can create titles for your recorded MDs and tracks as follows.

### During recording

If “CD-TEXT” flashes in the display during recording a CD, you can record the CD disc title on the MD (see page 25).

### After recording

Use the Name function on this page. You can input a total of approximately 1700 characters for the disc title and track titles on a single MD.

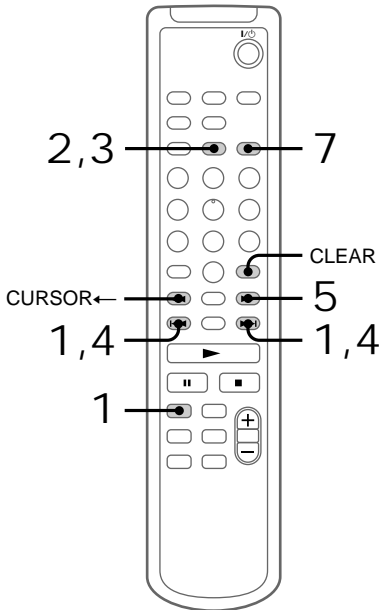

1 Press MD to switch the function to MD.  
To label a track, press ◀◀ or ▶▶ until the desired track number appears.

2 Press NAME EDIT.  
The text input screen appears, and the cursor flashes.

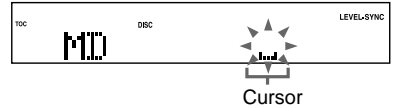

3 Press CHARACTER to select the desired type of character.  
Each time you press the button, the display changes as follows:  
A (Upper cases) → a (Lower cases) → 0 (Numbers) → ! (Symbols) → □ (Blank space) → A (Upper cases) → ...

4 Press ◀◀ or ▶▶ repeatedly to select the desired character.  
To enter a blank space  
Go to step 5 without pressing ◀◀ or ▶▶.  
You cannot enter a space as the first character.

To enter a symbol  
You can use the following 24 symbols.  
! " # \$ % & ' ( ) \* + , - . / : ; < = > ? @ \_ `

5 Press CURSOR→.  
The character you selected in step 4 stops flashing and the cursor shifts to the right.

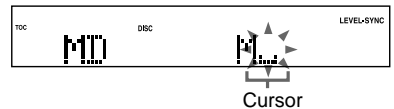

- 
- 6 Repeat steps 3 to 5 to complete the entire title.

If you made a mistake

Press CURSOR← or → until the character you want to change flashes, then repeat steps 3 to 5.

To erase a character

Press CURSOR← or → until the character you want to erase flashes, then press CLEAR.

---

- 7 Press ENTER/YES to complete the labelling procedure.

The titles you labelled appear sequentially.

---

To cancel labelling

Press MENU/NO before completing the procedure.

Tip

You can label a track title during play. The playing repeats until you finish labelling.

Note

If the MD is record protected, “C11” and “Protected” appear alternately and the MD cannot be edited. Remove the MD, then slide the record protection tab to the closed position (see page 22).

## Checking the titles

To check the disc titles, press SCROLL in stop mode. To check the track title, press SCROLL during play.

The title appears scrolling in the display. To stop scrolling, press SCROLL. Press the button again to resume scrolling.

## Erasing the titles

To erase the disc titles and all track titles at once

- 1 Press MENU/NO in stop mode.
- 2 Press ◀◀ or ▶▶ repeatedly until “MD Name ?” appears, then press ENTER/YES.
- 3 Press ◀◀ or ▶▶ repeatedly until “MD Nm Erase?” appears.
- 4 Press ◀◀ or ▶▶ repeatedly until “MD Nm All Ers?” appears, then press ENTER/YES. “MD Nm All Ers??” appears.
- 5 Press ENTER/YES. “MD Complete!!” appears, and the disc title and all track titles are erased.

To erase a disc title or a track title

Do steps 1 to 3 of “To erase the disc titles and all track titles at once”.

While “MD Nm Erase?” is displayed, press ENTER/YES so that “MD Nm Ers Disc” appears. Press ◀◀ or ▶▶ repeatedly until the disc title or the track number with the title you want to erase appears, then press ENTER/YES.

“MD Complete!!” appears, and the disc title or the track title is erased.

To cancel erasing

Press MENU/NO before completing the procedure.

To return to the condition before labelling or erasing

You can return to the original condition immediately after labelling or erasing a title by using the Undo function (see page 45).

# Erasing recordings

## — Erase Function

The MD deck lets you erase unwanted tracks quickly and easily. You can restore the contents to the condition before erasing (unerase) by using the Undo function. Note, however, you cannot undo an edit after performing any additional edits.

The three options for erasing recordings are:

- Erasing a single track (Track Erase function)
- Erasing all tracks (All Erase function)
- Erasing a portion of a track (A-B Erase function)

### Erasing a single track

#### — Track Erase function

You can erase a track simply by selecting its track number. When you erase a track, the total number of tracks on the MD decreases by one and all the tracks following the erased one are renumbered.

Example: Erasing track 2.

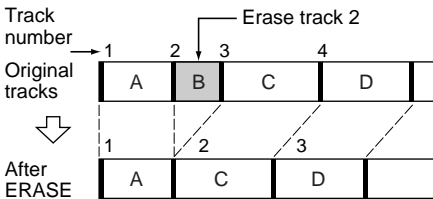

When erasing multiple tracks, you should proceed in order from high to low track number to prevent the renumbering of tracks that have not been erased yet.

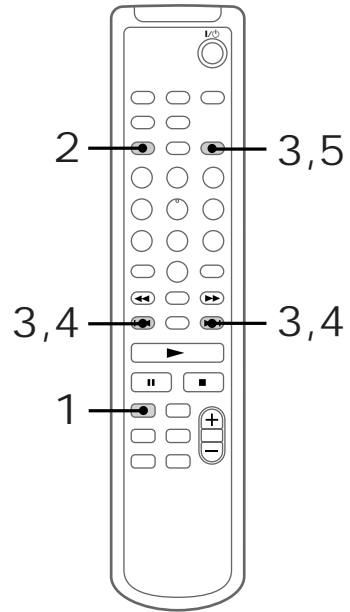

1 Press MD to switch the function to MD.

2 Press MENU/NO to display “MD Edit Menu”.

3 Press ◀◀ or ▶▶ repeatedly until “MD Tr Erase ?” appears, then press ENTER/YES.

4 Press ◀◀ or ▶▶ repeatedly until the desired track number appears.



5 Press ENTER/YES.

“MD Complete!!” appears for a few seconds and the selected track and title are erased.

## To cancel Track Erase

Press MENU/NO before completing the procedure.

## To return to the condition before Track Erase

You can return to the original condition immediately after erasing the track by using the Undo function (see page 45).

### Note

“Erase???” appears when the track was recorded or edited on another deck and is protected. To erase the track, press ENTER/YES while “Erase???” appears.

## Erasing all tracks — All Erase function

You can erase the disc title, all recorded tracks and their titles at once.

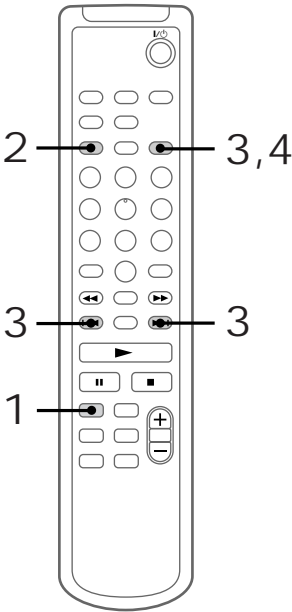

1 Press MD to switch the function to MD.

2 Press MENU/NO to display “MD Edit Menu”.

3 Press ◀◀ or ▶▶ repeatedly until “MD All Erase ?” appears, then press ENTER/YES.  
“MD All Erase ??” appears.

4 Press ENTER/YES again.  
“MD Complete!!” appears for a few seconds and the disc title, all recorded tracks and their titles are erased.

## To cancel All Erase

Press MENU/NO before completing the procedure.

## To return to the condition before All Erase

You can return to the original condition immediately after erasing the tracks by using the Undo function (see page 45).

## Erasing a portion of a track

### — A-B Erase function

You can specify a portion within a track and erase the portion with ease. You can shift the desired portion by frame\*, minute or second intervals. This function is convenient when erasing unnecessary sections after recording a satellite broadcast or FM broadcast.

\* 1 frame is 1/86 second.

Example: Erasing a portion of track 2.

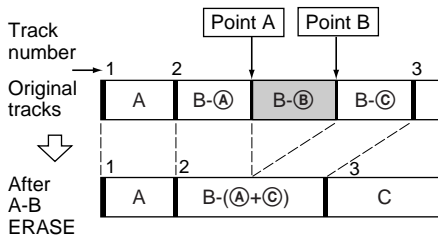

*continued*

## Erasing recordings (continued)

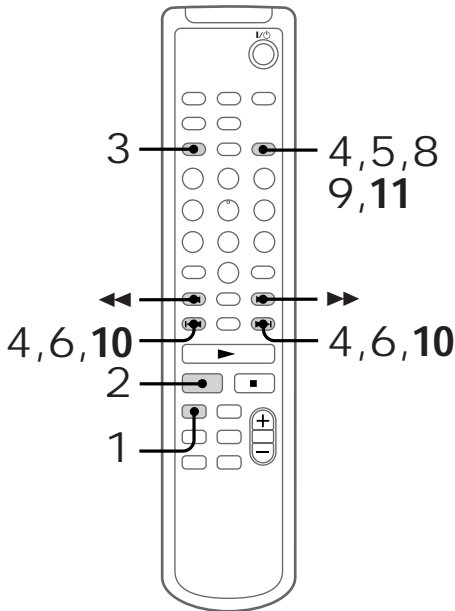

- 1 Press MD to switch the function to MD.
- 2 While playing an MD, press **||** at the starting point of the portion to be erased (point A).  
The MD deck pauses for play.
- 3 Press MENU/NO to display “MD Edit Menu”.
- 4 Press **◀◀** or **▶▶** repeatedly until “MD A-B Erase ?” appears, then press ENTER/YES.
- 5 Press ENTER/YES again.  
“MD - Rehearsal -” and “MD Point A ok?” appear alternately while the deck plays the selected track from the beginning to point A.

- 6 While monitoring the sound, press **◀◀** or **▶▶** repeatedly to find the starting point of the portion to be erased (point A).  
You can shift the starting point by 1/86 second (1 frame) intervals.  
To shift the point by second or minute intervals, press **◀◀** or **▶▶** so that “s” or “m” flashes, then press **◀◀** or **▶▶**.
- 7 Repeat step 6 until point A is played correctly.
- 8 Press ENTER/YES if point A is correct. “MD Point B Set” appears and playback for setting the ending point of the portion to be erased (point B) starts.
- 9 Continue playback until the deck reaches point B, then press ENTER/YES.  
“MD A-B Ers” and “MD Point B ok?” appear alternately and the deck repeats a portion of the few seconds before point A and after point B successively.
- 10 Press **◀◀** or **▶▶** repeatedly to find point B.  
The procedure is the same as step 6.
- 11 Press ENTER/YES if point B is correct. “MD Complete!!” appears for a few seconds and the portion between point A and B is erased.

### To cancel A-B Erase

Press MENU/NO before completing the procedure.



## To return to the condition before A-B Erase

You can return to the original condition immediately after erasing the track by using the Undo function (see page 45).

### Note

If “Impossible” appears, the specified portion cannot be erased. This happens when you have edited the same track many times. This is due to a technical limitation of the MD system and is not a mechanical error.

## Moving recorded tracks

### — Move Function

You can use this function to change the order of any track on the disc. When you move tracks, the tracks are automatically renumbered.

Example: Moving track 3 to position 2.

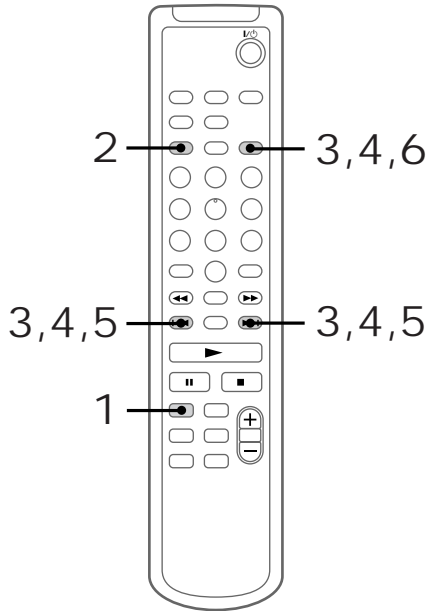
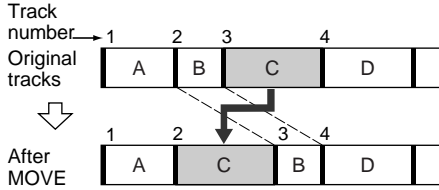

1 Press MD to switch the function to MD.

2 Press MENU/NO to display “MD Edit Menu”.

continued

## Moving recorded tracks (continued)

- 3 Press **◀◀** or **▶▶** repeatedly until “MD Move ?” appears, then press ENTER/YES.
- 4 Press **◀◀** or **▶▶** repeatedly until the desired track number to move appears, then press ENTER/YES.
- 5 Press **◀◀** or **▶▶** repeatedly until the new track position appears.

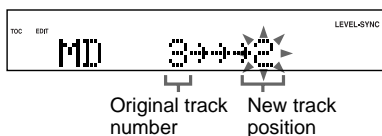

- 6 Press ENTER/YES.  
“MD Complete!!” appears for a few seconds and the selected track moves to the appointed position.

### To cancel moving

Press MENU/NO before completing the procedure.

### To return to the track order before Move

You can return to the original track order immediately after moving recorded tracks by using the Undo function (see page 45).

## Dividing recorded tracks

### — Divide Function

You can use this function to mark track numbers after recording. The total number of tracks increases by one and all the tracks following the divided ones are renumbered.

Example: Dividing track 2 into two tracks.

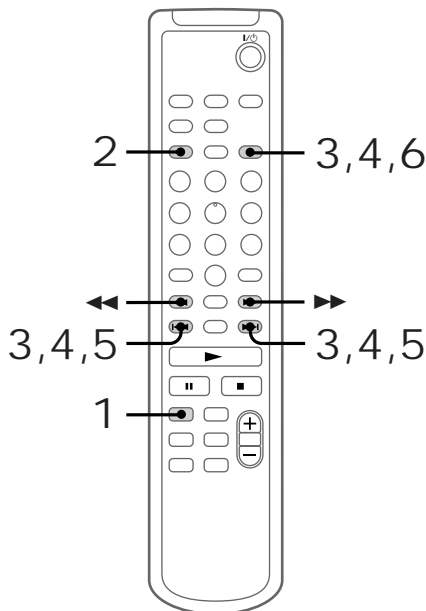
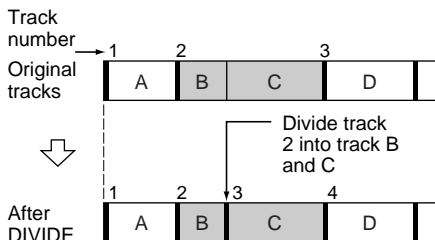

---

1 Press MD to switch the function to MD.

---

2 Press MENU/NO to display “MD Edit Menu”.

---

3 Press ◀◀ or ▶▶ repeatedly until “MD Divide ?” appears, then press ENTER/YES.

---

4 Press ◀◀ or ▶▶ repeatedly until the desired track number to divide appears, then press ENTER/YES.

“MD - Rehearsal -” appears and the portion to be divided is played repeatedly.

---

5 While monitoring the sound, press ◀◀ or ▶▶ repeatedly to adjust the point to be divided.

You can shift the point by 1/86 second (1 frame) intervals.

To shift the point by second or minute intervals, press ◀◀ or ▶▶ so that “s” or “m” flashes, then press ◀◀ or ▶▶.

---

6 Press ENTER/YES.

“MD Complete!!” appears for a few seconds and the newly created track starts playing.

---

### To cancel dividing

Press MENU/NO before completing the procedure.

### To return to the condition before Divide

You can return to the original condition immediately after dividing the tracks by using the Undo function (see page 45). You can also return to the original condition by using the Combine function (see page 44).

### Notes

- If you divide a labelled track into two tracks, only the first track retains the track title.

Example:

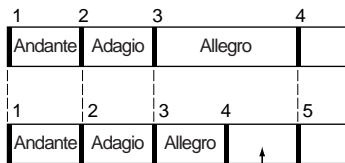

The new track is not labelled

- “Impossible” appears when you specify the division point at the beginning or end of a track. Press ◀◀ or ▶▶ to shift the position.

# Combining recorded tracks — Combine Function

You can use this function to combine 2 tracks into a single track. The total number of tracks decreases by one and all tracks following the combined ones are renumbered.

Example: Combining track 3 to track 1.

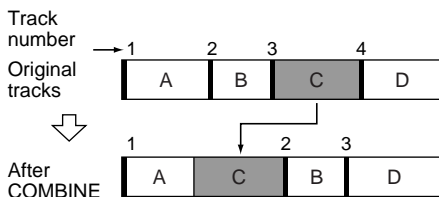

Example: Combining track 1 to track 4.

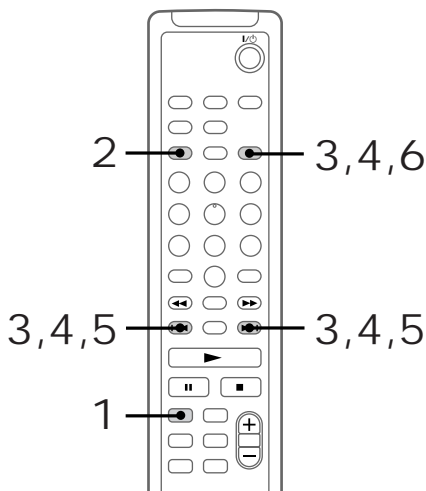
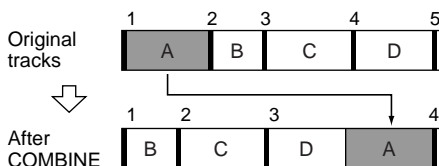

- 1 Press MD to switch the function to MD.
- 2 Press MENU/NO to display “MD Edit Menu”.
- 3 Press ◀◀ or ▶▶ repeatedly until “MD Combine ?” appears, then press ENTER/YES.

- 4 Press ◀◀ or ▶▶ repeatedly until the first track number of the two to be combined appears, then press ENTER/YES.

For example, to combine tracks 4 and 1, select 4.



First track number

- 5 Press ◀◀ or ▶▶ repeatedly until the second track number of the two to be combined appears.



Second track number to be number combined

- 6 Press ENTER/YES. “MD Complete!!” appears for a few seconds and the tracks are combined. Play starts.

## To cancel combining

Press MENU/NO before completing the procedure.

## To return to the condition before Combine

You can return to the original condition immediately after combining the tracks by using the Undo function (see this page). You can also return to the original condition by using the Divide function (see page 42).

### Notes

- If both of the combined tracks have track titles, the title of the second track is erased.
- If “Impossible” appears, the tracks cannot be combined. This happens when you have edited the same track many times. This is due to a technical limitation of the MD system and is not a mechanical error.

# Undoing the last edit

## — Undo Function

You can use this function to cancel the last edit and restore the contents of the MD to the condition before the edit.

Note, however, that you cannot undo an edit if you do any of the following after the edit:

- Do another edit.
- Press the ● REC or CD SYNC REC button.
- Update the TOC by turning off the system or ejecting the MD.
- Disconnect the mains lead.

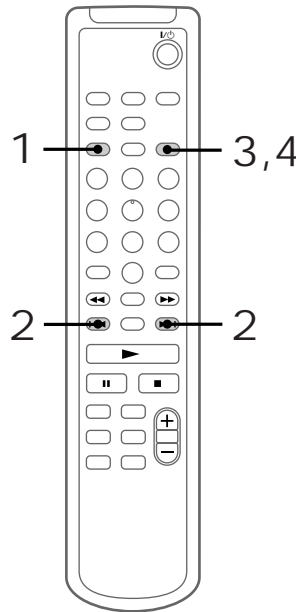

**1** Press MENU/NO in stop mode to display “MD Edit Menu”.

**2** Press ◀◀ or ▶▶ repeatedly until “MD Undo ?” appears.

“MD Undo ?” does not appear, when there is no editing function that can be cancelled.

*continued*

*Undoing the last edit (continued)***3** Press ENTER/YES.

One of the following messages appears, depending on the last edit.

Editing done	Message
Labelling a track or an MD	“MD Name Undo?”
Erasing labelled titles	
Erasing a single track	
Erasing all tracks	“MD Erase Undo?”
Erasing a portion of a track	
Moving a track	“MD Move Undo?”
Dividing a track	“MD Divide Undo?”
Combining tracks	“MD Combine Undo?”

**4** Press ENTER/YES again.

“MD Complete!!” appears for a few seconds and the contents of the MD are restored to the condition before the edit.

**To cancel Undo**

Press MENU/NO before completing the procedure.

## Presetting radio stations

You can preset up to 30 stations, 20 for FM and 10 for AM.

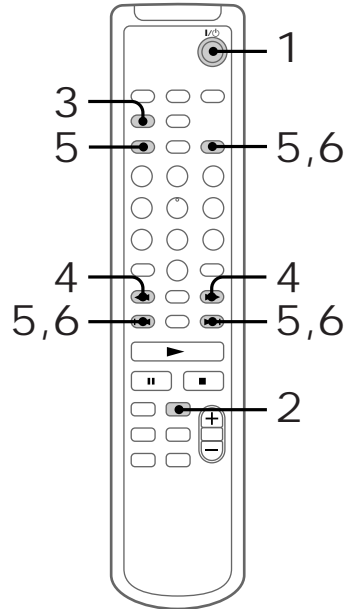

- 1 Press **I/⏻** (power) to turn on the system.
- 2 Press **BAND TUNER** repeatedly to select “AM” or “FM”.

- 
- 3 Press TUNING MODE repeatedly until “AUTO” appears.



- 
- 4 Press ◀◀ or ▶▶.

The frequency indication changes and the scanning stops when the system tunes in a station. “TUNED” and “STEREO” (for a stereo programme) appear.

When you want to stop scanning, press TUNING MODE.

- 
- 5 Press MENU/NO then ◀◀ or ▶▶ repeatedly until “P.Memory ?” appears, then press ENTER/YES.

The preset number flashes.

- 
- 6 Press ◀◀ or ▶▶ to select the preset number you want, then press ENTER/YES.

The station is stored.

Select 1 to 20 for FM, and select 1 to 10 for AM.

- 
- 7 Repeat steps 2 to 6 to preset other stations.
- 

To tune in a station with a weak signal

- 1 Press TUNING MODE repeatedly until “MANUAL” appears in step 3.
- 2 Press ◀◀ or ▶▶ repeatedly to tune in the station and continue from step 5.

To set another station to the exist preset number

Start over from step 2.

To change the AM tuning interval (except for the European model)

The AM tuning interval is factory-set to 9 kHz (10 kHz in some areas). To change the AM tuning interval, tune in any AM station first, then turn off the system. While holding down the TUNING + button, turn the system back on. When you change the interval, all the AM preset stations are erased. To reset the interval, repeat the same procedure.

Tips

- When a new station is memorized, the station formerly memorized at that preset number is erased.
- The preset stations are retained for about a week even if you disconnect the mains lead or if a power failure occurs.

# Listening to the radio

## — Preset Tuning

Preset radio stations in the tuner's memory first (see page 46).

To turn on the system, press I/⏻ (power).

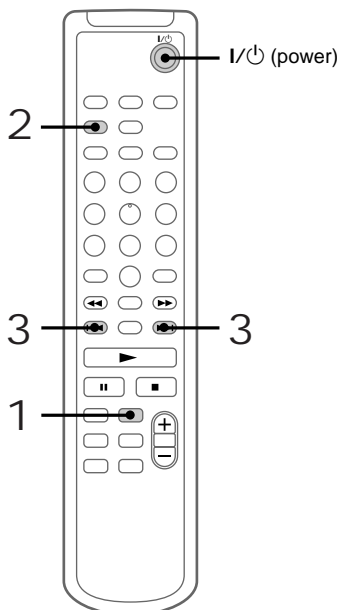

1 Press BAND TUNER repeatedly to select “AM” or “FM”.

2 Press TUNING MODE repeatedly until “PRESET” appears.



3 Press ◀◀ or ▶▶ to select the desired preset station.



Preset number and frequency (or station name\* or RDS station name\*\*)

\* The station name appears only if you have labelled the station (see page 49).

\*\* European model only.

To	Do this
Turn off the radio	Press I/⏻ to turn off the system.
Adjust the volume	Press VOLUME + or -.

## Listening to non-preset radio stations

- Press TUNING MODE repeatedly until “MANUAL” appears in step 2, then press ◀◀ or ▶▶ to tune in the desired station (**Manual Tuning**).
- Press TUNING MODE repeatedly until “AUTO” appears in step 2, then press ◀◀ or ▶▶. The frequency indication changes and the scanning stops when the system tunes in a station (**Automatic Tuning**).

To cancel Automatic Tuning  
Press TUNING MODE.



## Tips

- You can switch from another source to the tuner just by pressing TUNER/BAND on the tuner (**Automatic Source Selection**).
- To improve broadcast reception, adjust the supplied aerials, or connect a commercially available external aerial (see page 60).
- When an FM stereo programme has static noise, press STEREO/MONO on the remote until "MONO" appears. When receiving a monaural broadcast, "MONO" lights up in the display. There will be no stereo effect, but the reception will improve. Press the button again to restore the stereo effect.

## Labelling the preset stations — Station Name

You can label each preset station with up to 12 characters (Station Name). The Station Name appears when you tune in the station.

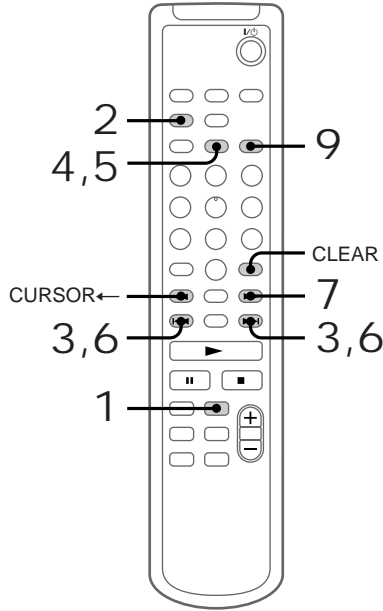

Tuner

- 1 Press BAND TUNER repeatedly to select "AM" or "FM".
- 2 Press TUNING MODE repeatedly until "PRESET" appears.
- 3 Press ◀◀ or ▶▶ repeatedly until the desired preset station to label appears.

*continued*

## Labelling the preset stations (continued)

### 4 Press NAME EDIT.

The text input screen appears, and the cursor flashes.



### 5 Press CHARACTER repeatedly to select the desired type of character.

Each time you press the button, the display changes as follows:

A (Upper cases) → a (Lower cases) → 0 (Numbers) → ! (Symbols) → □ (Blank space) → A (Upper cases) → ...

### 6 Press ◀◀ or ▶▶ repeatedly to select the desired character.

To enter a blank space

Go to step 7 without pressing ◀◀ or ▶▶.

You cannot enter a space as the first character.

To enter a symbol

You can use the following 24 symbols.

! " # \$ % & ' ( ) \* + , - . / : ; < = > ? @ \_ `

### 7 Press CURSOR→.

The character you selected in step 6 stops flashing and the cursor shifts to the right.



### 8 Repeat steps 5 to 7 to complete the entire title.

If you made a mistake

Press CURSOR← or → until the character you want to change flashes, then repeat steps 5 to 7.

To erase a character

Press CURSOR← or → until the character you want to erase flashes, then press CLEAR.

### 9 Press ENTER/YES to complete the labelling procedure.

#### To cancel labelling

Press MENU/NO before completing the procedure.

#### To check the station name

Press DISPLAY.

Each time you press the button, the display changes as follows:

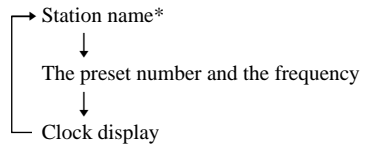

\* When the station is not labelled, the preset number and the frequency are displayed automatically.

#### To erase the name

Do steps 1 to 4 and press CLEAR repeatedly until the label disappears, then press ENTER/YES.

## Using the Radio Data System (RDS)

(European model only)

### What is the Radio Data System?

Radio Data System (RDS) is a broadcasting service that allows radio stations to send additional information along with the regular programme signal. RDS is available only on FM stations\*.

#### Note

RDS may not work properly if the station you are tuned in is not transmitting the RDS signal properly or if the signal is weak.

\* Not all FM stations provide RDS service, nor do they provide the same types of services. If you are not familiar with the RDS system, check with your local radio stations for details on RDS services in your area.

### Receiving RDS broadcasts

➔ Simply select a station from the FM band.

When you tune in a station that provides RDS services, the station name appears in the display.

#### To check the RDS information

Each time you press DISPLAY, the display changes as follows:

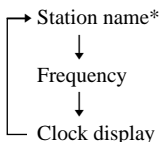

\* If the RDS broadcast is not received, the station name may not appear in the display.

## Falling asleep to music

— Sleep Timer

You can set the system to turn off after a certain time, so that you can fall asleep to music. You can preset the time to turn off in 10 minutes increments.

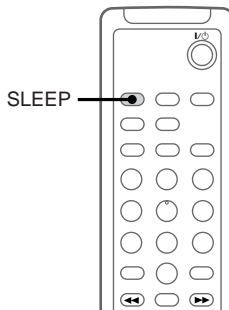

➔ Press SLEEP repeatedly to select a desired time.

Each time you press the button, the minute display (the turn-off time) changes as follows:

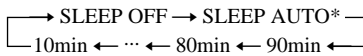

\* The system automatically turns off in 100 minutes, or after the current CD or MD finishes playing.

#### To check the turn-off time

Press SLEEP once. Nothing appears in the display for the “SLEEP AUTO” setting.

#### To change the time to turn off

Select the time you want by pressing SLEEP.

#### To cancel the timer

Press SLEEP repeatedly until “SLEEP OFF” appears.

continued

## Falling asleep to music (continued)

### Tips

- You can use Sleep Timer, even if you have not set the clock.
- The optional tape deck TC-SP55 also automatically turns off after the tape finishes playing if you select “SLEEP AUTO”.

### Notes

- When Sleep Timer is used, you cannot use other timer functions.
- Do not set to “SLEEP AUTO” during Synchro Recording on an MD or a tape with the optional tape deck TC-SP55.

---

## Waking up to music

### — Daily Timer

You can wake up to music at a preset time. Make sure you have set the clock (see page 8). To wake up to the radio, preset the radio stations first (see page 46).

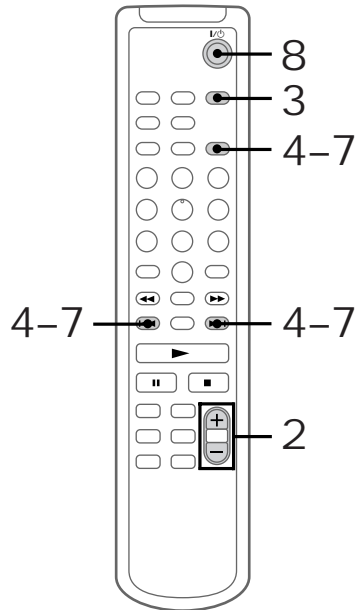

- 1 Prepare the sound source you want to play.
  - CD: Place a CD. To start from a specific track, make a programme (see page 11).
  - MD: Insert an MD. To start from a specific track, make a programme (see page 19).
  - Radio: Tune in a station (see page 48).
  - Tape: Insert a tape in the optional tape deck TC-SP55.

### Note

To wake up to a tape, you can use the optional tape deck TC-SP55 only.

---

2 Press VOLUME + or – to adjust the volume.

---

3 Press CLOCK/TIMER SET.

---

4 Press ◀◀ or ▶▶ repeatedly to display “SET DAILY”, then press ENTER/YES.

The hour indication flashes.

---

5 Set the time to start play.

Press ◀◀ or ▶▶ repeatedly to set the hour, then press ENTER/YES.

The minute indication flashes.



Press ◀◀ or ▶▶ repeatedly to set the minute, then press ENTER/YES.

The hour indication flashes again.

---

6 Set the time to stop play following the procedure in step 5.

“OFF TIME NG” appears if the start time and the stop time settings are the same.

Change the stop time.

---

7 Press ◀◀ or ▶▶ repeatedly to select the desired sound source, then press ENTER/YES.

The indication changes as follows:

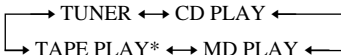

\* Select this to use the optional tape deck TC-SP55 as the sound source.

When you press ENTER/YES, the start time, the stop time and the sound source appear in turn, before the original display returns. “DAILY” lights up.

---

8 Press I/⏻ to turn off the system.

---

To cancel the procedure  
Press CLOCK/TIMER SET.

To change the setting  
Start over from step 1.

To check the setting/activate the timer

Press CLOCK/TIMER SELECT and press ◀◀ or ▶▶ repeatedly until “SEL DAILY” appears. Then press ENTER/YES.

It is not necessary to set the start and stop times every time.

To cancel the timer

Press CLOCK/TIMER SELECT and press ◀◀ or ▶▶ repeatedly until “TIMER OFF” appears. Then press ENTER/YES.

Notes

- You cannot activate Daily Timer and recording timer at the same time.
- Do not operate the system from the time the system turns on until the play starts (about 30 seconds before the preset time).
- If the system is on at the preset time, the set sound source starts playing.

# Timer recording radio programmes

To timer record, you must first preset the radio station (see page 46) and set the clock (see page 8). You can make a timer recording of a radio programme or the audio signal from a digital component connected to AUX IN (see page 57).

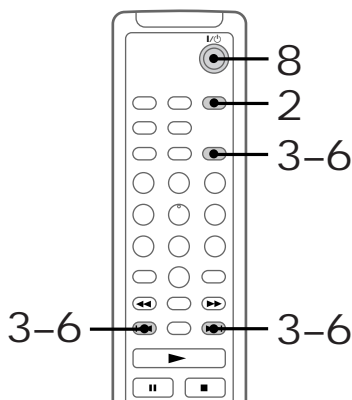

- 1 Prepare the sound source you want to play.
  - Radio: Tune in the preset radio station (see page 48).
  - AUX: Set the timer of the component connected to DIGITAL OPTICAL AUX IN. For details, refer to the operating instructions of the connected component.
- 2 Press CLOCK/TIMER SET.
- 3 Press ◀◀ or ▶▶ repeatedly until “SET MD REC” (or “SET TAPE REC” when using the optional tape deck TC-SP55) appears, then press ENTER/YES. The hour indication flashes.

- 4 Set the time to start recording. Press ◀◀ or ▶▶ repeatedly to set the hour, then press ENTER/YES. The minute indication flashes.



Press ◀◀ or ▶▶ repeatedly to set the minute, then press ENTER/YES. The hour indication flashes again.

- 5 Set the time to stop recording following the procedure in step 4. “OFF TIME NG” appears if the start time and the stop time settings are the same. Change the stop time.

- 6 Press ◀◀ or ▶▶ repeatedly to select the recording source, then press ENTER/YES.

The indication changes as follows:

When recording on an MD

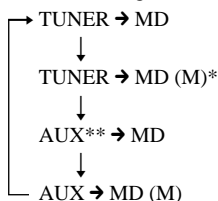

\* When you record onto an MD in monaural format.

\*\* You can select the connected component for recording source. Set the timer on both systems to the same time.

When recording on a tape with the optional tape deck TC-SP55

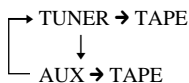

When you press ENTER/YES, the start time, stop time and other setting contents appear in turn, then the original display returns.

“REC” lights up.

#### Note

You cannot activate another tape deck (except for the optional tape deck TC-SP55) with this system’s recording timer.

---

## 7 Insert a recordable MD or tape.

If you use a partially recorded MD, recording starts after the recorded tracks.

---

## 8 Press I/⏻ to turn off the system.

---

### To cancel the procedure

Press CLOCK/TIMER SET.

### To change the setting

Start over from step 1.

### To check the setting/activate the timer

Press CLOCK/TIMER SELECT and press ◀◀ or ▶▶ repeatedly until “SEL MD REC” (or “SEL TAPE REC” when using the optional tape deck TC-SP55) appears.

Then press ENTER/YES.

It is not necessary to set the start and stop times every time.

### To cancel the timer

Press CLOCK/TIMER SELECT and press ◀◀ or ▶▶ repeatedly until “TIMER OFF” appears. Then press ENTER/YES.

### Tips

- The system automatically turns on about 30 seconds before the start time and prepares for timer-recording. Recording starts as soon as the system is ready, so recording may start earlier than the preset time.
- When you record from the radio, the station name (see page 49, or frequency when the station is not labelled), the start time and the stop time are automatically recorded on the MD.

### Notes

- You cannot activate Daily Timer and the recording timer at the same time.
- Do not operate the system from the time the system turns on until the recording starts (about 30 seconds before the preset time).
- If the system is on about 30 seconds before the preset time, the timer-recording will not be activated.
- The Smart Space and Level Synchro Recording functions do not operate.
- The volume is reduced to minimum during recording.

## Adjusting the sound

You can adjust the bass and treble using the DSG (Dynamic Sound Generator) function.

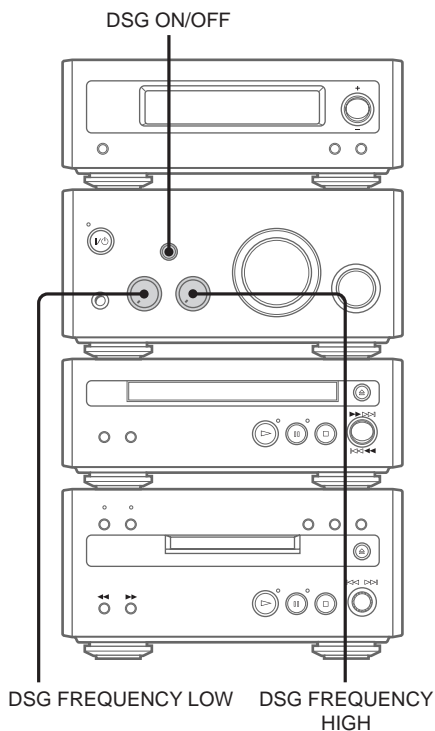

### Adjusting the bass

- ➔ Press DSG ON/OFF to display “DSG”, then turn DSG FREQUENCY LOW. You can adjust the bass from MIN to MAX.

### Adjusting the treble

- ➔ Press DSG ON/OFF to display “DSG”, then turn DSG FREQUENCY HIGH. You can adjust the treble from MIN to MAX.

### Generating a more dynamic sound

- ➔ Press DSG ON/OFF. When DSG is on, “DSG” lights up.



## Connecting a digital component

Connect the digital component using audio cords (not supplied) and an optical cable (square optical connector, not supplied). The digital audio signal from the connected component is digitally recorded to the MD.

The analogue connection is for monitoring the audio, and the digital connection is for recording. If there is no analogue connection, no sound will be produced from the speaker. The digital audio signal from the connected component is recorded to the MD. However, if the digital component is not connected to the DIGITAL OPTICAL AUX IN, the audio connected to the AUX IN (analogue) will be recorded as an analogue signal. Also refer to the operating instructions for each component.

To the audio output of a digital component

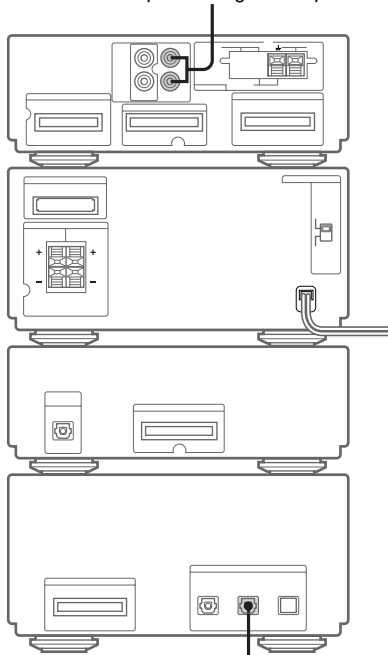

To the digital optical output of a digital component

- 1 Connect an optical cable (square optical connector, not supplied).

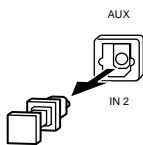

- 1 Take the cap off the DIGITAL OPTICAL AUX IN.

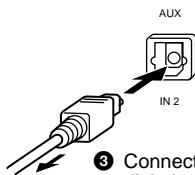

- 2 Connect an optical cable.

- 3 Connect the cable to the digital optical output of a digital component.

- 2 Connect an audio cords (not supplied).

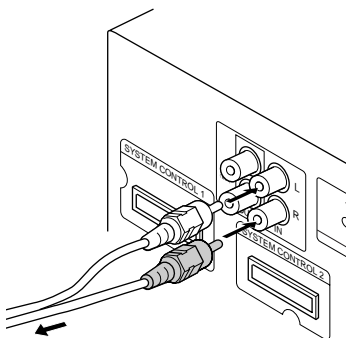

Connect the cords to the audio output of a digital component.

### Tip

Switch the function to “AUX” when listening to or recording the sound of connected components.

*continued*

## Connecting a digital component (continued)

### Notes

- Digital recording is prohibited for most DVD software. To record DVD software for which digital recording is prohibited, disconnect the optical cable and make an analogue recording.
- A built-in sampling rate converter lets you make a digital recording of the sound from a digital component to the MD deck regardless of the source frequency (32 kHz, 44.1 kHz, 48.0 kHz).
- If the optical cable is not connected or incorrectly connected, or if the optical cable is connected but there is some problem with the input digital signal, the system automatically switches to analogue recording and the audio is recorded in analogue format.
- When connecting the DVD player's DIGITAL OUT jack to the MD deck's DIGITAL OPTICAL AUX IN jack, set the DVD player so that the signals output from the player's DIGITAL OUT jack are downmixed to 2 channels (2ch linear PCM). If the DVD player is set to 5.1ch output, you cannot record to the MD.

---

## Connecting an analogue component

To enhance your system, you can connect optional components. Analogue sound from the connected component is recorded as an analogue signal on the MD.

Refer to the operating instructions of each component.

### Connecting the optional tape deck TC-SP55

CD Synchro Recording and Timer-recording are possible when the SYSTEM CONTROL 3 connectors are connected.

Disconnect the supplied system cable from the SYSTEM CONTROL 3 connectors on the tuner and MD deck, and connect the system cable supplied with the tape deck in the order of the tuner, tape deck and MD deck.

Refer to the operating instructions included with the TC-SP55 tape deck for details on the connection and operation.

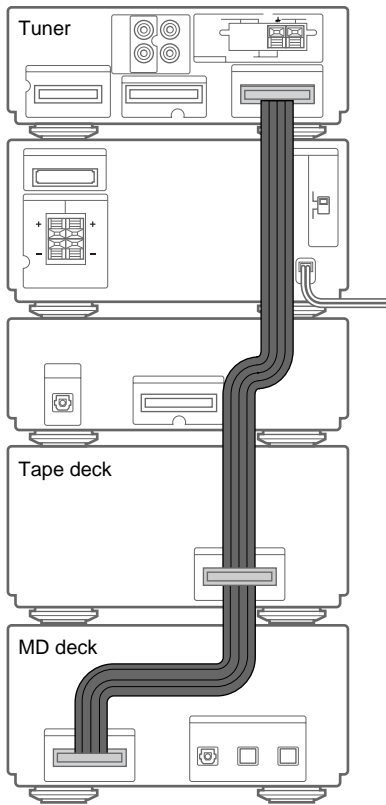

**Tip**  
Switch the function to “TAPE” when listening to or recording the sound of the TC-SP55 tape deck.

## Connecting another tape deck, TV, VCR, etc.

Connect the component to the AUX IN and OUT jacks on the rear panel of the tuner.

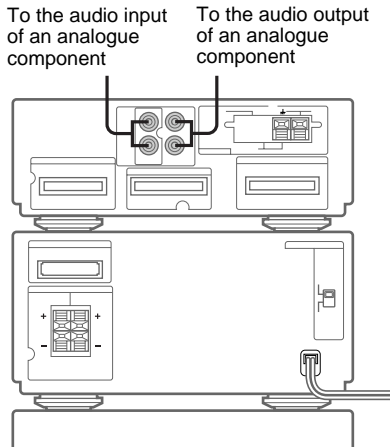

### Tips

- Switch the function to “AUX” when listening to or recording the sound of the connected components.
- When making a recording, start the recording after “D-IN” changes to “A-IN”.

### To attenuate the distortion from the connected components

You can change the audio input level for the AUX input jacks between two levels.

If the sound from a connected component is distorted, reduce the input level.

- 1 Turn FUNCTION until “AUX” appears.
- 2 Press **I/⏻** to turn off the system.
- 3 While holding down DSG ON/OFF, press **I/⏻** to turn on the system.  
“AUX ATT” appears in the display.

When the volume is too low, do steps 1 to 3 again to reset to the original level.

continued

## Connecting an analogue component (continued)

When “OVER” lights up during recording from the connected components

A signal in excess of the specified level was input during recording. Perform the following operations and then record the source again.

- 1 Press MENU/NO twice during recording or recording pause.  
“Setup Menu” appears.
- 2 Turn ◀◀/▶▶ until “Level Adjust ?” appears, then press ENTER/YES.
- 3 Turn ◀◀/▶▶ to adjust the recording level. The recording level can be adjusted from -12 to +12. Make sure that “OVER” does not appear in the display at the loudest portion.
- 4 Press ENTER/YES.
- 5 Press MENU/NO.

### Note

If “OVER” appears in the display when the recording level is between -12 and 0, change the audio input level and reduce the input sound (see page 59).

## Connecting external aerials

Connect an external aerial to improve reception.

### FM aerial

Connect an commercially available FM external aerial, or you can use a TV aerial instead.

#### Jack type ①

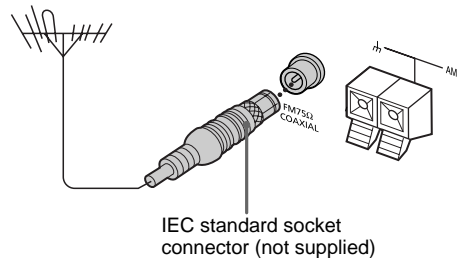

#### Jack type ②

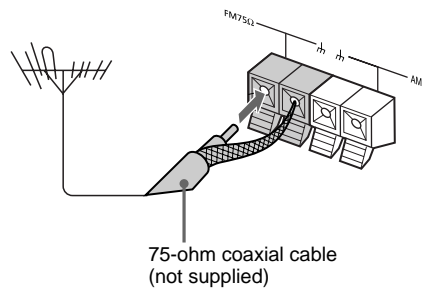

## AM aerial

Connect a 6- to 15- meter insulated wire to the AM aerial terminal. Leave the supplied AM loop aerial connected.

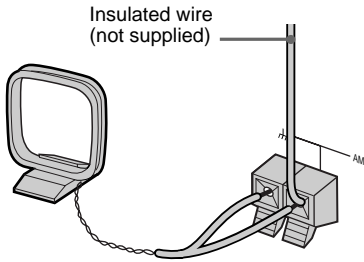

## Important

If you connect an external aerial, connect a ground wire to the *h* terminal. To prevent a gas explosion, do not connect the ground wire to a gas pipe.

## Precautions

On operating voltage  
(For the model with the voltage selector)

- Before operating the system, check that the operating voltage of your system is identical with the voltage of your local power supply.
- The voltage selector is located at the rear of the apparatus.

## On safety

- The unit is not disconnected from the AC power source (mains) as long as it is connected to the wall outlet, even if the unit itself has been turned off.
- Unplug the system from the mains if it is not to be used for an extended period of time. To disconnect the mains lead, pull it out by the plug. Never pull the cord itself.
- Should any solid object or liquid fall into the system, unplug the system and have it checked by qualified personnel before operating it any further.
- AC power cord (mains lead) must be changed only at the qualified service shop.
- When you connect the mains lead to the mains, even if the power is off, the system begins charging for remote and timer functions. Therefore the surface of this unit become warm, this is normal.

## On placement

- Make sure the system fan is on during use. Place the system in a location with adequate air circulation, and do not place anything on top of the system.
- Place the system in a location with adequate ventilation to prevent heat build up.
- Do not place the system in an inclined position.
- Do not place the system in locations where it is;
  - Extremely hot or cold
  - Dusty or dirty
  - Very humid
  - Subject to vibrations
  - Subject to direct sunlight.

continued

## Precautions (continued)

### On operation

If the system is brought directly from a cold to a warm location, or is placed in a very damp room, moisture may condense on the lens inside the CD player or the MD deck. Should this occur, the system will not operate properly. Remove the CD or MD and leave the system turned on for about an hour until the moisture evaporates.

### On transportation

- Make sure you remove discs, and turn off the system. If you move the system with the discs inserted, you may be unable to remove the discs.
- Before you move the system, turn off the system and make sure all operations have finished.

If you have any questions or problems concerning your system, please consult your nearest Sony dealer.

### On the speaker system

This speaker system is magnetically shielded and can be used near TV sets. However, the picture on some TV sets may become magnetically distorted. In such a case, turn off the power of the TV set once, and after 15 to 30 minutes turn it on again.

**If there seems to be no improvement**, locate the speaker system further away from the TV set. Also, be sure not to place objects in which magnets are attached or used near the speaker system, such as audio racks, TV stands, and toys. These may cause magnetic distortion to the picture due to their interaction with the system.

## Notes on MDs

- If you try to force the shutter open, the disc may be damaged. If the shutter opens, close it immediately without touching the disc inside.
- Affix the label supplied with the disc only to the specified label indentation. Do not affix the label around the shutter or in other locations. Note that the shape of the indentation depends on the disc.

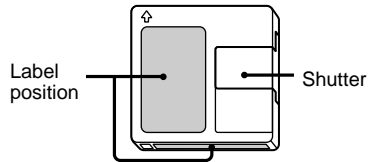

- Wipe the disc cartridge with a dry cloth to remove dirt.
- Do not expose the MD to direct sunlight or heat sources such as hot air ducts, nor leave it in a car parked in direct sunlight.

## Notes on CDs

- Before playing, clean the CD with a cleaning cloth. Wipe the CD from the centre out.
- Do not use a CD with tape, seals, or paste on it as this may damage the player.
- Do not use solvents such as benzene, thinner, commercially available cleaners, or antistatic spray intended for vinyl LPs.
- Do not expose the CD to direct sunlight or heat sources such as hot air ducts, nor leave it in a car parked in direct sunlight.

## Cleaning the cabinet

Use a soft cloth slightly moistened with mild detergent solution.

# System limitations of MDs

The recording system in your MD deck has the limitations described below.

Note, however, that these limitations are due to the inherent nature of the MD recording system itself, not to mechanical causes.

“MD Disc Full” appears before the MD has reached the maximum recording time

When 255 tracks have been recorded on the MD, “MD Disc Full” appears regardless of the total recorded time. More than 255 tracks cannot be recorded on the MD. To continue recording, erase unnecessary tracks or use another recordable MD.

“MD Disc Full” appears before the maximum number of tracks (255) is reached

Fluctuations in emphasis within tracks are sometimes interpreted as track intervals, increasing the track count and causing “MD Disc Full” to appear.

The remaining recording time does not increase even after erasing numerous short tracks

Tracks shorter than 12 seconds are not counted, so erasing them may not increase the recording time.

Some tracks cannot be combined with others

Track combination may become impossible when tracks are shorter than 8 seconds.

The total recorded time and the remaining time on the MD do not add up to the maximum recording time

Recording is done in minimum units of 2 seconds each, no matter how short the material. The recorded contents may be shorter than the maximum recording capacity. Disc space may also be reduced by scratches.

The sound may drop-out while searching the edited tracks

Tracks created through editing may exhibit sound dropout during searching because high-speed playback requires time to search for the position on the disc when the tracks are not in order.

Track numbers cannot be marked

When “LEVEL-SYNC” (see page 31) lights up in the display window during analogue recording, the track numbers may not be marked at the beginning of the track:

- if the input signal is below a certain fixed level for less than two seconds between tracks.
- if the input signal is below a certain fixed level for more than two seconds in the middle of the track.

## Guide to the Serial Copy Management System

Digital audio components, such as CDs, MDs, and DATs let you copy music easily with high quality by processing music as a digital signal.

To protect the copyrighted music programmes, this system uses the Serial Copy Management System that allows you to make only a single copy of a digitally recorded source through digital-to-digital connections.

**You can make only a first generation copy\* through a digital-to-digital connection.**

That is:

- 1 You can make a copy of a commercially available digital sound programme (for example, a CD or MD), but you cannot make a second copy from the first-generation copy.
  - 2 You can make a copy of a digital signal from a digitally recorded analogue sound programme (for example, an analogue record or a music cassette tape) or from a digital satellite broadcast programme, but you cannot make a second copy.
- \* A first-generation copy means a digital recording of a digital signal made on digital audio equipment. For example, if you record from this system’s CD player to the MD deck, you make a first-generation copy.

### Note

This copy management system doesn’t apply when you make a recording through analogue-to-analogue connections.

---

# Troubleshooting

If you have any problem using this system, use the following checklist.

First, check that the mains lead is connected firmly and that the speakers are connected correctly and firmly.

Should any problem persist, consult your nearest Sony dealer. When bringing the system in for repairs, be sure to bring in the entire system. This product is a system product, and the entire system is needed to determine the location requiring repair.

## General

---

### **There is no sound.**

- Turn VOLUME clockwise.
- Make sure the headphones are not connected.
- Check the speaker connections (see page 6).
- Connect the audio cord to AUX IN jacks.

### **Sound comes from one channel, or unbalanced left and right volume.**

- Connect the speaker cords properly (see page 6).
- Place the speakers as symmetrically as possible.
- Connect only one of the supplied speakers to each set of speaker terminals.
- Connect the supplied speakers.

### **There is severe hum or noise.**

- Move the system away from the source of noise.
- Connect the system to a different mains.
- Install a noise filter (commercially available) to the mains line.

### **“--:--” appears.**

- Set the clock again (see page 8).

### **The timer cannot be set.**

- Set the clock again (see page 8).

---

### **The timer does not function.**

- Check the set contents and set the correct time (see pages 51 – 55).
- Connect the optional tape deck TC-SP55 properly (see page 58).
- Refer to the operating instructions included with the connected component, and set the timer to the same time as the system's timer.

### **The remote does not function.**

- Remove the obstacle.
  - Move the remote closer to the system.
  - Point the remote at the system's sensor.
  - Replace the batteries (R6/size AA).
  - Locate the system away from the fluorescent light.
- 

## CD Player

---

### **The CD tray does not close.**

- Place the CD correctly in the centre of the tray.
- Always close the tray by pressing  on the CD player. Trying to push the tray closed with your fingers may cause problems with the CD player.

### **The CD does not eject.**

- Consult your nearest Sony dealer.

### **Play does not start.**

- Open the CD tray and check whether a CD is loaded.
- Wipe the CD clean (see page 62).
- Replace the CD.
- Place the CD correctly in the centre of the tray.
- Place the CD in the tray with the label side up.
- Remove the CD and wipe away the moisture on the CD, then leave the system turned on for a few hours until the moisture evaporates.
- Press  on the CD player to start play.



---

**The sound skips.**

- Wipe the CD clean (see page 62).
- Replace the CD.
- Try moving the system to a place without vibration (e.g., on top of a stable stand).
- Try moving the speakers away from the system, or placing them on separate stands. When you listen to a track with bass sounds at high volume, the speaker vibration may cause the sound to skip.

---

**Play does not start from the first track.**

- Press PLAY MODE repeatedly until “PROGRAM” or “SHUFFLE” disappears to return to normal play.

---

**“- OVER -” appears.**

- Keep pressing  $\lll$  or press  $\lll$  repeatedly on the CD player to return to the desired playing position.

---

**Tuner**

---

**Severe hum or noise/stations cannot be received.**

- Set the proper band and frequency (see page 46).
- Connect the aerial properly (see page 6).
- Find a place and an orientation that provide good reception, then set up the aerial again. If you cannot obtain good reception, we recommend you connect a commercially available external aerial.
- The supplied FM lead aerial receives signals along its entire length, so make sure you extend it fully.
- Locate the aerials as far away from the speaker cords as possible.
- Consult your nearest Sony dealer if the supplied AM aerial has come off the plastic stand.
- Try turning off surrounding electrical equipments.

---

**A stereo FM programme cannot be received in stereo.**

- Press STEREO/MONO on the remote until “STEREO” appears in the display.
- See “Severe hum or noise/stations cannot be received.”, and check the aerial condition.

---

**Cyclical static noise is heard while recording on an MD.**

- Adjust the aerial orientation and position until the noise stops.

---

**MD Deck**

---

**An MD cannot be inserted.**

- Insert the MD with the arrow side up and the arrow pointing toward the deck.

---

**The controls do not work.**

- Replace the MD with a new one.
- Retry the operations after “TOC” turns off.

---

**Play does not start.**

- Replace the MD.
- Insert the MD and leave the system turned on for a few hours until the moisture evaporates.
- Press  $\triangleright$  on the MD deck to start play.

---

**The sound skips.**

- Replace the MD.
- Try moving the system to a place without vibration (e.g., on top of a stable stand).
- Try moving the speakers away from the system, or placing them on separate stands. When you listen to a track with bass sounds at high volume, the speaker vibration may cause the sound to skip.
- Insert the disc and wait for a few hours with the system turned on.

continued

---

**Play does not start from the first track.**

- Press PLAY MODE repeatedly while the MD deck is in stop mode until “PROGRAM” or “SHUFFLE” disappears to return to normal play.

---

**“-OVER-” appears.**

- Keep pressing ◀◀ on the MD deck or turn |◀◀/▷▷| on the MD deck counter-clockwise to return to the desired playing position.

---

**“OVER” lights up during recording.**

- Adjust the recording level (see page 32).

---

**Recording or editing was done, but the TOC is not updated.**

- MD recording and editing contents are recorded to the MD when the MD is removed, so make sure you remove the MD after recording or editing (see pages 22 and 35).

---

**Recording is not possible.**

- Remove the MD and slide the tab to close the slot (see page 22).
- Connect the optional component properly (see pages 57 – 59).
- Switch the function to desired sound source.
- Replace the MD with a recordable MD, or use the Erase function to erase unnecessary tracks (see pages 38 – 41).
- Start recording over from the beginning.

---

**The sound from an MD you recorded is too low (or too high).**

- Readjust the recording level (see page 32).
- 

---

**There is no sound.**

- Refer to General item “There is no sound.” on page 64 and check the condition of the system.
- Connect the component properly (see pages 57 – 59) while checking:
  - if the cords/cables are connected properly.
  - if the cord/cable connectors are firmly inserted all the way.
- Turn on the connected component.
- Refer to the operating instructions included with the connected component and start playing.

---

**The sound is distorted.**

- Attenuate the distortion (see page 59).

---

**The sound from the component connected to the AUX IN jacks is not heard.**

- Turn FUNCTION until “AUX” appears.
  - Connect the audio cord securely.
- 

If the system still does not operate properly after performing the above measures, reset the system as follows:

- 1 Unplug the mains lead.
- 2 While holding down , connect the mains lead to the mains.

The system is reset to the factory settings. All the settings you made such as the preset stations, clock, timer and CD disc titles are cleared. You should set them again.

---

# Self-diagnosis Display

This system has a Self-diagnosis display function to let you know if there is a system malfunction. The display shows a code made up of three letters and a message alternately to show you the problem. To solve the problem refer to the following list. If any problem persists, consult your nearest Sony dealer.

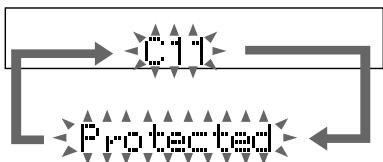

---

## C11/Protected

The MD is protected against erasure.

→Remove the MD and slide the tab to close the slot (see page 22).

---

## C12/Cannot Copy

You tried to record a CD or MD with a format that the system does not support, such as a CD-ROM.

→Remove the disc and turn off the system once, then turn it on again.

---

## C13/RECError

Recording could not be performed properly.

→Move the system to a stable place, and start recording over from the beginning.

The MD is dirty or scratched, or the MD does not meet the standards.

→Replace the MD and start recording over from the beginning.

---

## C13/ReadError

The MD deck cannot read the disc information properly.

→Remove the MD once, then insert it again.

---

## C14/TocError

The MD deck cannot read the disc information properly.

→Replace the MD.

→Erase all the recorded contents of the MD using the All Erase function (see page 39).

---

## C41/Cannot Copy

The sound source is a copy of a commercially available music software, or you tried to record a CD-R (Recordable CD).

→The Serial Copy Management System prevents making a digital copy (see page 63). You cannot record a CD-R.

---

## C71/CheckOPT-IN

This appears momentarily because of the signal of the digital broadcast during recording.

→There is no affect on the recorded contents.

No component is connected to the DIGITAL OPTICAL IN jack, or a digital component is not connected properly.

→Connect a digital component to the DIGITAL OPTICAL IN jack properly using a digital connecting cable (an optical cable) (not supplied, see page 57).

The connected digital component is not turned on.

→See the operating instructions supplied with the connected component and confirm whether the component is turned on.

The digital connecting cable (an optical cable) connected to the DIGITAL OPTICAL IN jack is pulled out, or the connected digital component is turned off during digital recording.

→Connect the cable, or turn on the digital component.

---

# Messages

One of the following messages may appear or flash in the display during operation.

MD

---

## AutoCut

The MD deck is pausing the recording because silence continued for 30 seconds or more during digital recording.

---

## BlankDisc

The inserted recordable MD is new, or all tracks on the MD have been erased.

---

## CannotEdit

- A pre-mastered MD is in the deck.
  - You tried to edit in Programme or Shuffle Play mode.
- 

## CannotREC

- A pre-mastered MD is in the deck.
  - The function is switched to MD.
- 

## Complete!!

The editing operation of MDs is completed.

---

## Impossible

- You tried to make an impossible editing operation.
  - You cannot combine the tracks due to the system limitations of MDs.
- 

## Disc Full!!

There is no time remaining on the MD.

---

## Eject

The MD deck is ejecting the MD.

---

## NoDisc

There is no disc in the MD deck.

---

---

## NameFull

There is no more space to store track or disc titles.

---

## NoName

You tried to show the title of a non-labelled disc or track.

---

## -OVER-

You have reached the end of the MD while keep pressing ►► on the MD deck during playing pause.

---

## PositionOK?

The position to be divided by the Divide function is being played.

---

## PushSTOP!

You pressed PLAY MODE during play.

---

## -Rehearsal-

The MD is playing the specified dividing point for confirmation during the Divide function.

---

## SmartSpace

The signal was input again after silence continued for 3 or more but less than 30 seconds during digital recording.

---

## TextProtect

There is CD TEXT information which cannot be recorded on the MD.

---

---

**TOCReading**

The MD deck is reading the TOC information of the MD.

---

**TOCWriting**

The MD deck is writing the information of recorded or edited contents.

---

**TrackEnd**

You have reached the end of the track while adjusting the dividing point during the Divide function.

---

---

**CD****NameFull**

There are already 50 disc titles stored in the system.

---

**-OVER-**

You have reached the end of the CD while keeping pressing ►►►► on the CD player during pause.

---

**CannotEdit**

You tried to label a CD TEXT disc.

---

---

# Specifications

**Tuner section (ST-SP55)**

FM stereo, FM/AM superheterodyne tuner

Input

AUX IN (phono jacks): voltage 250 mV, impedance 47 kilohms

Output

AUX OUT (phono jacks): voltage 250 mV, impedance 1 kilohm

**FM tuner section**

Tuning range 87.5 – 108.0 MHz  
(50 kHz step)

Aerial FM lead aerial

Aerial terminals 300 ohms unbalanced

Intermediate frequency 10.7 MHz

**AM tuner section**

Tuning range

European model: 531 – 1,602 kHz  
(with the interval set at 9 kHz)

Other models: 531 – 1,602 kHz  
(with the interval set at 9 kHz)  
530 – 1,710 kHz  
(with the interval set at 10 kHz)

Aerial AM loop aerial

External aerial terminals

Intermediate frequency 450 kHz

**Amplifier section (TA-SP55)****European model:**

DIN power output (Rated): 25 + 25 watts (8 ohms at 1 kHz, DIN, 230 V)

Continuous RMS power output (Reference):

30 + 30 watts (8 ohms at 1 kHz,  
10% THD, 230 V)

Music power output (Reference):

75 + 75 watts

continued

## Specifications (continued)

### Other models:

DIN power output (Rated): 25 + 25 watts (8 ohms at 1 kHz, DIN, 240 V)

22 + 22 watts (8 ohms at 1 kHz, DIN, 220 V)

Continuous RMS power output (Reference):

30 + 30 watts (8 ohms at 1 kHz, 10% THD, 240 V)

28 + 28 watts (8 ohms at 1 kHz, 10% THD, 220 V)

Output

PHONES (stereo phono jack):

accepts headphones of 8 ohms or more.

### CD player section (CDP-SP55)

System Compact disc and digital audio system

Laser Semiconductor laser ( $\lambda=780$  nm)  
Emission duration: continuous

Laser output Max. 44.6  $\mu$ W\*

\*This output is the value measured at a distance of 200 mm from the objective lens surface on the Optical Pick-up Block with 7 mm aperture.

Frequency response 20 Hz – 20 kHz

Output

DIGITAL OPTICAL OUT: Optical

### MD deck section (MDS-SP55)

System MiniDisc digital audio system

Laser Semiconductor laser ( $\lambda=780$  nm)  
Emission duration: continuous

Laser output Max. 44.6  $\mu$ W\*

\*This output is the value measured at a distance of 200 mm from the objective lens surface on the Optical Pick-up Block with 7 mm aperture.

Sampling frequency 44.1 kHz

Frequency response 20 Hz – 20 kHz

Inputs

DIGITAL OPTICAL CD IN:

Optical

DIGITAL OPTICAL AUX IN:

Optical

Output

DIGITAL OPTICAL OUT: Optical

### Speaker (SS-CSP55)

Speaker system 2-way, bass-reflex type

Speaker units

Woofer: 12 cm dia., glass-fiber cone type

Tweeter: 2.5 cm dia., balanced drive type

Nominal impedance 8 ohms

### General

Power requirements

European model: 230 V AC, 50/60 Hz

Other models: 110 – 120 V or 220 – 240 V AC, 50/60 Hz

Power consumption 70 watts

Dimensions (w/h/d) incl. projecting parts and controls

Tuner section: Approx. 202 × 75 × 291 mm

Amplifier section: Approx. 202 × 101 × 306 mm

CD player section: Approx. 202 × 75 × 290 mm

MD deck section: Approx. 202 × 101 × 298 mm

Speaker: Approx. 170 × 275 × 230 mm

Mass

Tuner section: Approx. 1.3 kg

Amplifier section: Approx. 3.9 kg

CD player section: Approx. 1.5 kg

MD deck section: Approx. 1.7 kg

Speakers: Approx. 3.4 kg net per speaker

Supplied accessories Remote (1)

R6 (size AA) batteries (2)

AM loop aerial (1)

FM lead aerial (1)

Speaker cords (2)

System cables (2)

Digital cable (1)

Design and specifications are subject to change without notice.

# Index

## A

- A-B Erase Function 39
- Adjusting
  - the bass 56
  - the operating voltage 7
  - the recording level 32
  - the sound 56
  - the treble 56
  - the volume 9, 17, 48
- Aerials 6, 60, 61
- After
  - editing 35
  - recording 22
- All Erase Function 39
- Analogue recording 22, 58
- Auto Cut 28
- Automatic Source Selection 9, 17, 49
- Automatic tuning 48

## B

- Batteries 7
- Before
  - editing 35
  - recording 22

## C

- CD-MD Synchro Recording 23, 24
- Clock setting 8
- Combine Function 44
- Connecting. *See* Hooking up

## D

- Daily Timer 52
- Digital recording 22, 57
- Disc Memo 14
- Disc Memo information 16
- Display 13, 21
- Divide Function 42
- Dynamic Sound Generator 56

## E, F, G

- Erase Function 38
- Erasing
  - a portion of a track 39
  - a single track 38
  - a track number 44
  - all tracks on an MD 39
  - titles on an MD 37

## H, I, J, K

- Hooking up
  - external aerial 60
  - optional components 57, 58
  - the aerials 6
  - the mains 7
  - the speakers 6

## L

- Labelling
  - a CD 14
  - a preset station 49
  - an MD 36
- Level Synchro Recording 31
- Listening to the radio 48

## M

- Manual tuning 48
- Messages 68
- Monaural recording 33
- Move Function 41

## N

- Name Function 36
- Normal Play 9, 17

## O

- Optional components 57

## P, Q

- Playing
  - a CD 9 – 12
  - an MD 17 – 20
  - tracks in random order (Shuffle Play) 10, 18
  - tracks in the desired order (Programme Play) 11, 19
  - tracks repeatedly (Repeat Play) 12, 20
- Preset Tuning 48
- Presetting radio stations 46
- Programme Play 11, 19
- Protecting recordings 22

## R

- Radio Data System 51
- Radio stations
  - presetting 46
  - tuning in 48
- Recording
  - a CD 23, 24, 26
  - a radio programme 27
  - manual recording 26, 27
  - monaural recording 33
  - on an MD 23, 24, 26, 27, 29, 33, 54
  - timer-recording 54
- Repeat Play 12, 20
- Resetting the system 66

*continued*

## *Index (continued)*

### **S**

- Saving recordings 22
- Self-diagnosis display 67
- Serial copy management system 63
- Setting the time 8
- Shuffle Play 10, 18
- Sleep Timer 51
- Smart Space 28
- Speakers 6
- Station Name 49
- System limitations of MDs 63

### **T**

- Time Machine Recording 29
- Timer
  - falling asleep to music 51
  - timer-recording 54
  - waking up to music 52
- Track Erase Function 38
- Track marking 31, 42
- Troubleshooting 64
- Tuning interval 47

### **U, V, W, X, Y, Z**

- Undo Function 45