

VIDEO CD Player

Operating Instructions



MCE-CX80K

WARNING

To prevent fire or shock hazard, do not expose the unit to rain or moisture.

To avoid electrical shock, do not open the cabinet. Refer servicing to qualified personnel only.

Laser component in this product is capable of emitting radiation exceeding the limit for Class 1.

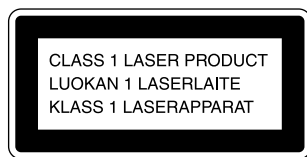

This appliance is classified as a CLASS 1 LASER product. The CLASS 1 LASER PRODUCT MARKING is located on the rear exterior.

Welcome!

Thank you for purchasing the Sony Video Compact Disc (VIDEO CD) Player. Before operating the unit, please read this manual thoroughly and retain it for future reference.

About This Manual

The instructions in this manual are for model MCE-CX80K.

Conventions

- Instructions in this manual describe the controls on the player. You can also use the controls on the remote if they have the same or similar names as those on the player.
- The following icons are used in this manual:



Indicates that you can use only the remote to do the task.



Indicates tips and hints for making the task easier.

TABLE OF CONTENTS

This Player Can Play the Following Discs	4
-------------------------------------------------------	---

Getting Started	
Unpacking	4
Hooking Up the System	5

Basic Operations	
Playing a VIDEO CD	7

Enjoying Karaoke	
Using the Microphone	9

Locating a Scene or Track You Want	
Using the On-Screen Display	10
Using the Front Panel Display	12
Replacing Discs While Playing a Disc	13
Locating a Specific Disc	13
Playing Two Discs Consecutively	14
Resuming Playback from the Point You Stopped a VIDEO CD (Resume Play)	14
Locating a Specific Track	15
Locating a Point by Elapsed Time (Time Search)	15
Locating a Particular Point in a Scene or Track	16
Locating by Observing Several Scenes at One Time (Digest Play)	17

Playing CDs in Various Modes	
Playing Repeatedly	19
Playing in Random Order (Shuffle Play)	20
Creating Your Own Program (Program Play)	21
Enjoying Picture Effects	22
Enjoying Sound Effects	23
Switching the Sound	23
Controlling the TV with the Supplied Remote	24



Enjoying Karaoke with Non-Karaoke Discs	
Playing Karaoke with Any Stereo Discs (Karaoke Pon)	24

Enjoying Playback Using the PBC Functions	
Playing VIDEO CDs with PBC Functions (PBC Playback)	25
Locating Scenes Directly Using the Scene Numbers (Scene Search)	26

Additional Information	
Precautions	27
Notes on Discs	28
Troubleshooting	28
Specifications	29
Glossary	29

Index	30
--------------------	----

This Player Can Play the Following Discs

	VIDEO CDs	Audio CDs
Disc logo		
Contents	Audio + Video (moving pictures)	Audio
Disc size	12 cm/8 cm	12 cm/8 cm (CD single)
Play time	74 min./20 min.	74 min./20 min.

To play VIDEO CDs, see page 7.

To enjoy PBC Playback of VIDEO CDs with PBC functions, see page 25.

To use the microphones, see page 9.

Note on VIDEO CDs

This player conforms to Ver. 1.1 and Ver. 2.0 of VIDEO CD standards. You can enjoy two kinds of playback according to the disc type.

Disc type	You can
VIDEO CDs without PBC functions (Ver. 1.1 discs)	Enjoy video playback (moving pictures) as well as music.
VIDEO CDs with PBC functions (Ver. 2.0 discs)	Play interactive software using menu screens displayed on the TV screen (PBC Playback), in addition to the video playback functions of Ver 1.1 discs. Moreover, you can play high-resolution still pictures.

Getting Started

Unpacking

Check that you received the following items:

- Audio and video connecting cord (1)
- Remote commander (remote) RMT-C98V (1)
- Sony R6 (size AA) batteries (2)

Keep the carton and packing material

They will come in handy when transporting the player (see page 6).

Inserting batteries into the remote

You can control the player using the supplied remote. Insert two R6 (size AA) batteries by matching the + and – on the batteries. When using the remote, point it at the remote sensor  on the player.

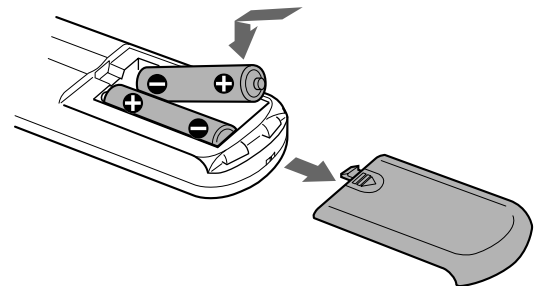

You can control Sony TVs with the mark using the supplied remote

See page 24.

When to replace batteries

With normal use, the batteries should last for about six months. When the remote no longer operates the player, replace all the batteries with new ones.

Notes

- Do not leave the remote near an extremely hot or humid place.
- Do not drop any foreign object into the remote casing, particularly when replacing the batteries.
- Do not expose the remote sensor to direct sunlight or lighting apparatuses. Doing so may cause a malfunction.
- If you don't use the remote for an extended period of time, remove the batteries to avoid possible damage from battery leakage and corrosion.

Hooking Up the System

Overview

This section describes how to hook up the VIDEO CD player to a TV (with audio/video input jacks) and/or an amplifier. Be sure to turn off the power of each component before making the connections.

When listening to the sound through TV speakers

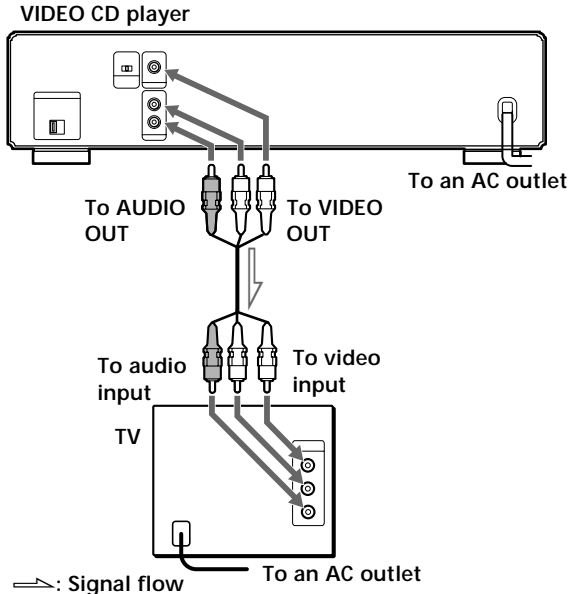

When listening to the sound through speakers connected to an amplifier

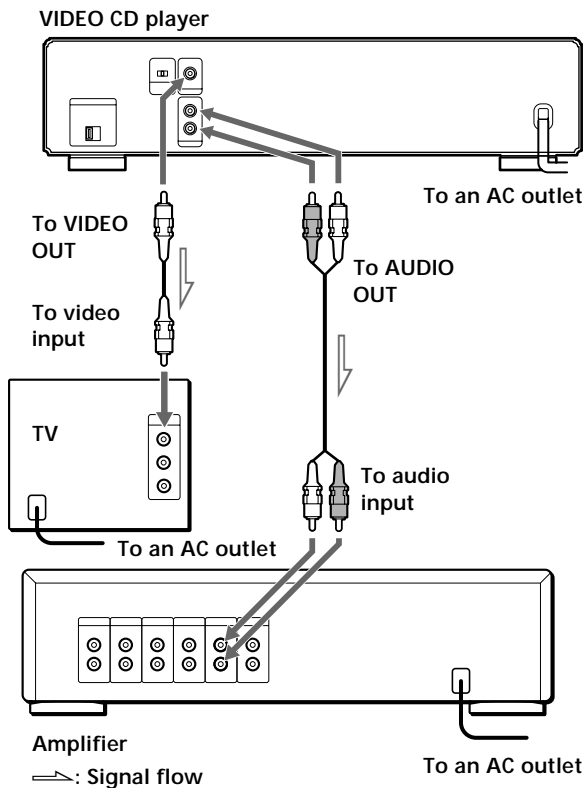

What cords will I need?

Audio and video connecting cord (supplied) (1)

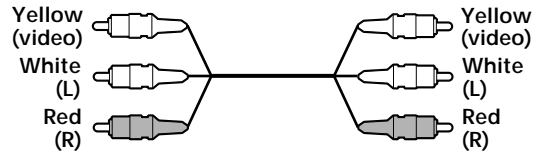

Video connecting cord (not supplied) (1)

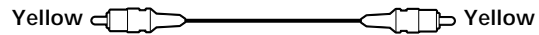

Audio connecting cord (not supplied) (1)

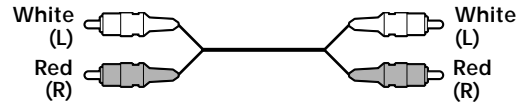

Hookups

When connecting the cord, be sure to match the color-coded cord to the appropriate jacks on the components: Yellow (video) to Yellow, Red (right) to Red and White (left) to White. Be sure to make connections firmly to avoid hum and noise.

When listening to the sound through TV speakers

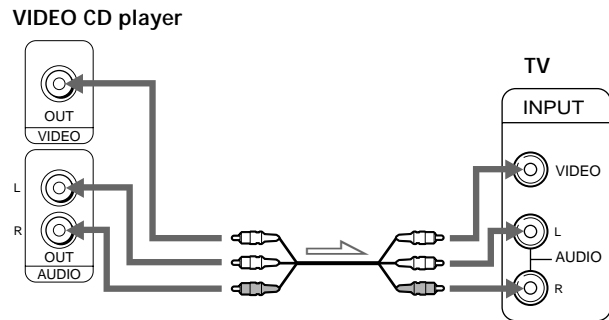

When listening to the sound through speakers connected to an amplifier

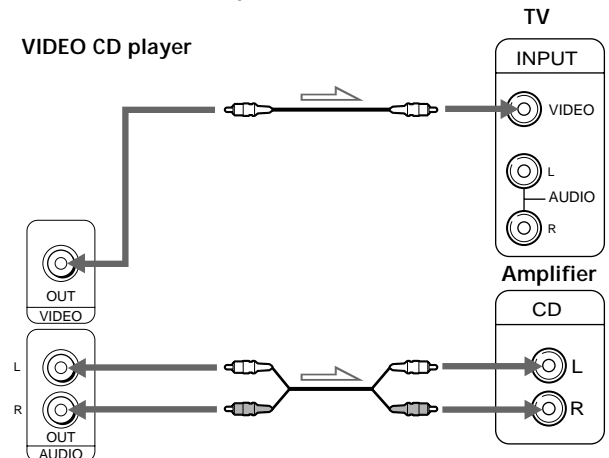

(Continued)

Important

Setting the color system switch

This player conforms to the NTSC and PAL color systems. Set the COLOR SYSTEM switch on the rear of the player to the appropriate position, according to your TV.

- **If the color system of your TV is NTSC:**
Set the COLOR SYSTEM switch to NTSC. Pictures will not be displayed if you set the switch to PAL. When you play a VIDEO CD based on PAL system, the picture will be stretched vertically and will be displayed with the lower part of the picture cut off.
- **If the color system of your TV is PAL:**
Set the COLOR SYSTEM switch to PAL. Pictures will not be displayed if you set the switch to NTSC. When you play a VIDEO CD based on NTSC system, the picture will be stretched horizontally and will be displayed with the upper and lower parts of the screen masked in black.
- **If your TV automatically changes the color system according to the input signal:**
Of course, pictures will be displayed with the switch set to either NTSC or PAL. But if you set the COLOR SYSTEM switch to AUTO, the player automatically changes the color system of video output according to the VIDEO CD to be played. In this case, the color system selected remains until you turn off the player, or you play another VIDEO CD with a different color system. If you turn off the player, the color system will be set to PAL automatically when you turn on the player again.

Be sure to turn off and on the player when you change the setting.

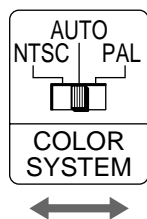

Setting the VOLTAGE SELECTOR

Check that the VOLTAGE SELECTOR on the rear panel of the player is set to the local power line voltage. If not, set the selector to the correct position using a screwdriver before connecting the AC power cord to a wall outlet.

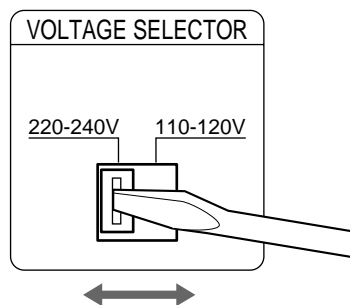

Connecting the AC power cord

Connect the AC power cord to a wall outlet.

Transporting the player

Before transporting the player, follow the procedure below to return the internal mechanisms back to their original position.

- 1 Remove all the discs from the disc tray.
- 2 Press OPEN/CLOSE to close the disc tray. "no dISC" appears in the display.
- 3 Wait for 10 seconds, then press I/OFF to turn off the player.
- 4 Disconnect the AC power cord from a wall outlet.
- 5 Put the player in the original carton and transport the player.

Playing a VIDEO CD

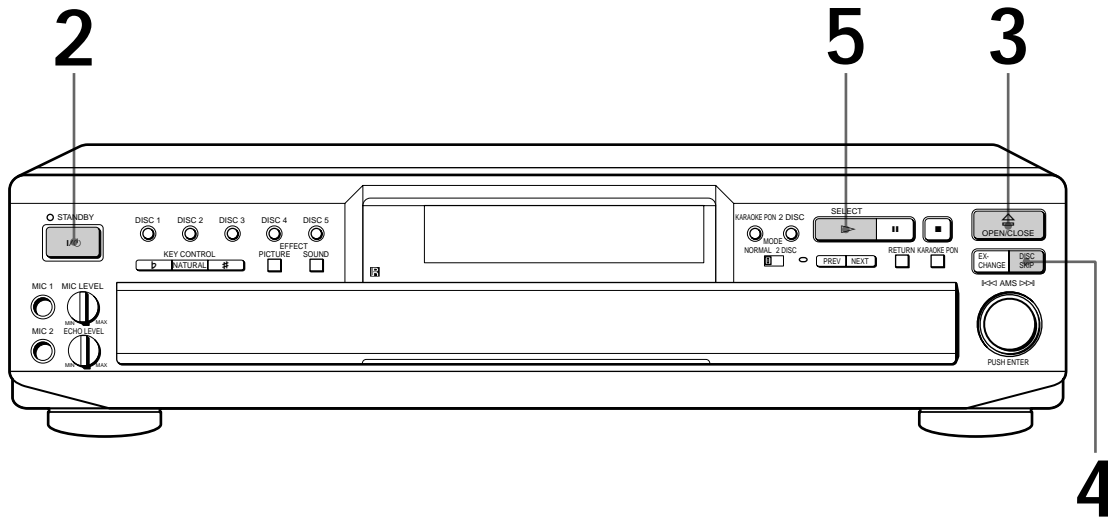

- See pages 5 - 6 for the hookup information.
- You can also play audio CDs just like VIDEO CDs.
- When you turn on the player, "SONY" logo appears on the TV screen. When you press any button, the logo disappears thereafter.

You can turn on or off the player using the remote. Press I/O on the remote. You can also directly turn on the player by pressing the OPEN/CLOSE or DISC SKIP button on the player.

When playing VIDEO CDs with PBC functions
In Step 5, the menu screen appears on the TV screen. You can play the VIDEO CD interactively, following the instructions on the menu screen. (PBC Playback, see page 25.)

What is a VIDEO CD with PBC functions?
See page 25 or 29.

1 **When using a TV**
Turn on the TV and select the video input so that you can view the pictures from this player.

When using an amplifier
Turn on the amplifier and select the CD player position so that you can listen to the sound from this player.

2 Press I/O to turn on the player.

3 Press OPEN/CLOSE, and place the discs into the disc trays. The disc on the left (DISC 1) is played first.

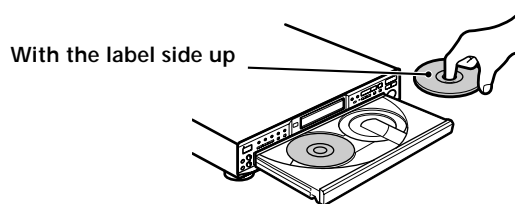

4 To place other discs, press DISC SKIP and place the discs in the order you want to play.

Each time you press the button, the disc tray turns and you can place the discs in the empty disc compartments.

5 Press DISC SKIP.
The disc tray closes and the player plays all discs in the player consecutively in the order of disc number (Continuous Play). Adjust the volume on the TV or the amplifier.

When "RESUME" appears in the front panel display
 You can resume playback from the point you stopped the VIDEO CD (Resume Play, see page 14).

The player enters standby mode automatically (Sleep function)

When 20 minutes elapse after the player stops, it enters standby mode.

Pressing the player's button during standby mode:

If there is a disc in the disc tray, the disc starts playing. If there is no disc in the disc tray, the player turns on and "no dISC" appears in the display.

Pressing the player's button during standby mode:

The disc tray opens.

What is a track?

A disc is divided into sections of a picture or a music piece called "tracks." Each track is assigned with a track number to locate the track you want.

To stop playback

Press ■.

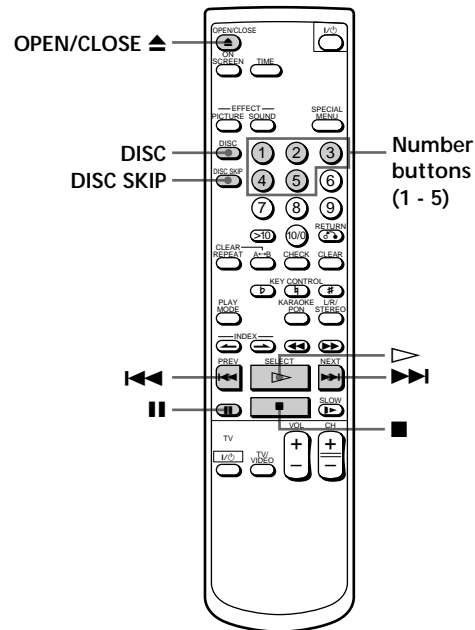
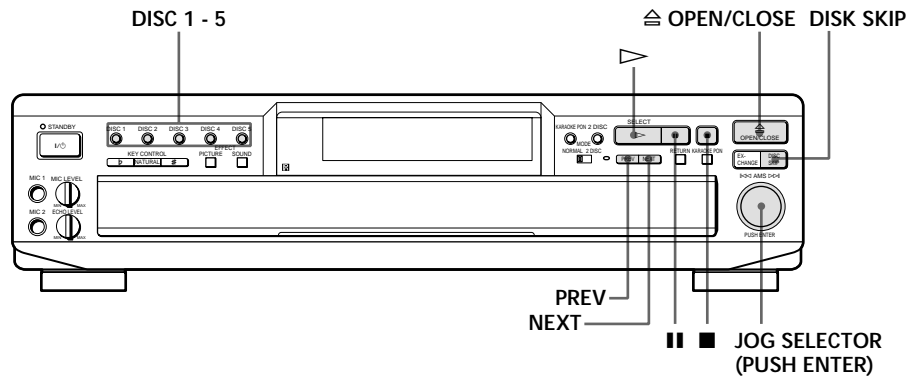

To	Press
Pause	■
Resume play after pause	■ or ▷
Go to the next disc	DISC SKIP
Select a disc directly	DISC 1 - 5 (or DISC and number button of the disc (1 - 5) on the remote)
Select the track (in Continuous Play mode)	<p>While playing, on the player:</p> <ul style="list-style-type: none"> • Turn JOG SELECTOR to select the track number • Press NEXT to go to the next scene or track • Press PREV to go back to the preceding scene or track <p>While playing, on the remote:</p> <ul style="list-style-type: none"> • Press ►► to go to the next scene or track • Press ◄◄ to go back to the preceding scene or track <p>Before you start playing: Turn JOG SELECTOR, or press NEXT, PREV, ◄◄ or ►► to select the track number, then press JOG SELECTOR or ▷</p>
Stop play and remove the CD	OPEN/CLOSE (or OPEN/CLOSE ▲ on the remote)

Using the Microphone

You can play karaoke (singing along) with CDs using the Karaoke Pon (see page 24).

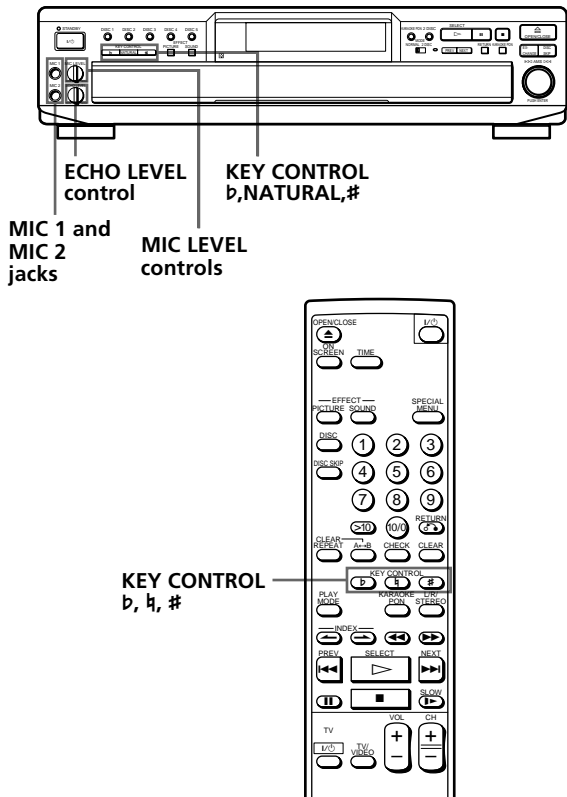

- 1 Set the MIC LEVEL control on the player to MIN, then plug the microphone(s) into the MIC 1 and/or MIC 2 jacks.

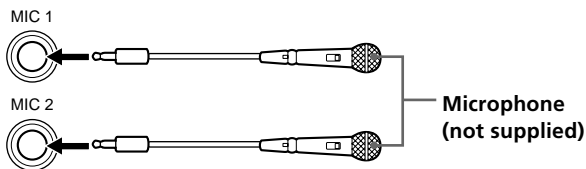

- 2 Turn the MIC LEVEL control to adjust the microphone volume.

Notes

- If howling occurs:
 - Move the microphone(s) away from the TV or the speakers.
 - Lower the volume of the TV or the amplifier.
 - Lower the microphone volume or echo level.
- If the sound is distorted when the player is connected to a TV:
 - Lower the microphone volume and music level.



When you don't use the microphone(s)

Unplug the microphone(s), switch the microphone(s) off and turn the MIC LEVEL control to MIN.

Changing the key (Key Control)

You can change the key to suit your vocal range.

While playing karaoke, press one of the KEY CONTROL buttons repeatedly to find the key that suits your vocal range.

To	Press
Raise the key	#
Lower the key	b
Return to the original key	NATURAL (or h on the remote)

You can adjust the key to 11 steps (5 steps higher, 5 steps lower and the original key).

The setting appears in the front panel display and on the TV screen.



When the track finishes playing or when you return to the menu screen

The player automatically returns to the original key.

Note

While you're watching Slide Show, the KEY CONTROL buttons become inoperable.

Adjusting the echo level

You can give an echo effect to the sound from the microphones.

Turn the ECHO LEVEL control to adjust the strength of echo.

The same echo level is applied to both microphones connected to the MIC 1 and MIC 2 jacks.

Note

If you don't want any echo effect, set the ECHO LEVEL control to MIN.

Using the On-Screen Display

You can check the operating status of the player and the information about the disc with the on-screen display on the TV screen.

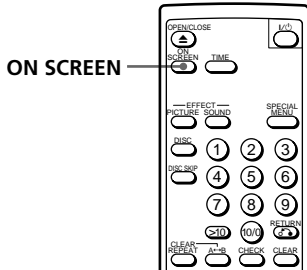

Press ON SCREEN.
Each time you press the button, the on-screen display changes as follows:

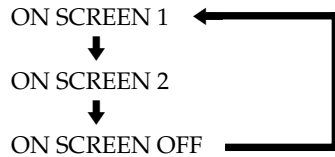

When using a VIDEO CD

■ Display information of ON SCREEN 1 mode

The operating status is displayed for a few seconds only when you change the operating status.



- Playing status on the current track**
- "PLAY" when you start playing in pause mode
 - "D1-1" etc. when you start playing in stop mode
 - "RESUME PLAY" when you resume playing in stop mode
 - "STOP" etc. when you stop playing
 - "PAUSE" when you pause playing

- Before you start playing (except for the Program Play mode)

When Resume Play is available

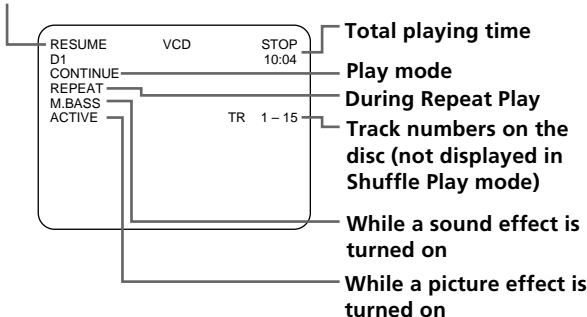

- Before you start playing in Program Play mode

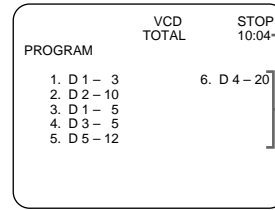

■ Display information of ON SCREEN 2 mode

While playing a disc, the current track number and the playing time are always displayed.
The operating status is displayed for a few seconds only when you change the operating status.

- Before you start playing (except for the Program Play mode)

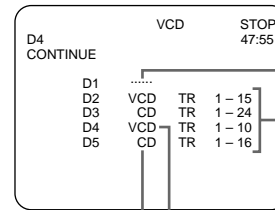

- Before you start playing in Program Play mode

The same information as in ON SCREEN 1 is displayed.

- During PBC Playback (page 25)

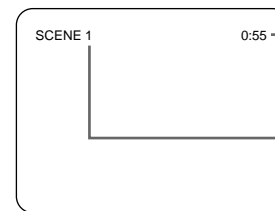

■ Display information of ON SCREEN OFF mode

No information is displayed.

When using an audio CD

In ON SCREEN 1 mode and ON SCREEN 2 mode, the information which appears during the using of an audio CD is the same (except during the conditions explained in "Before you start playing (except for the Program Play mode)" below).

■ Display information of ON SCREEN 1 or ON SCREEN 2

- In Continuous or Shuffle Play mode

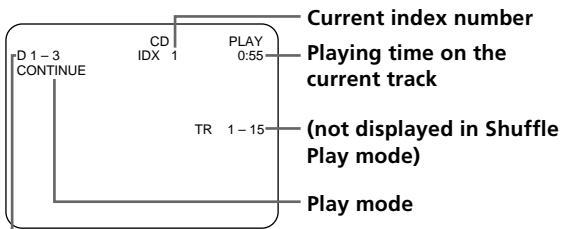

Current disc and track number

- In Program Play mode

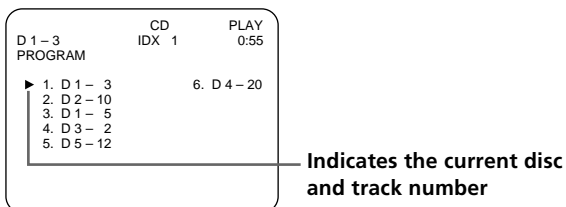

- Before you start playing (except for the Program Play mode)

ON SCREEN 1 mode

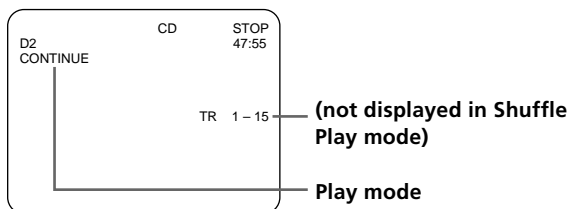

ON SCREEN 2 mode

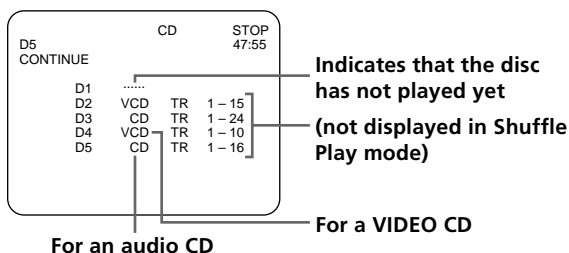

- Before you start playing in Program Play mode

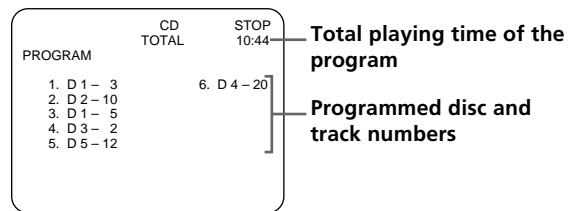

- Display information of ON SCREEN OFF mode

No information is displayed.

Notes

- See page 9 for the display information while using the microphone.
- Set the display mode other than ON SCREEN OFF. When you select ON SCREEN OFF, you cannot check the operating status while operating the player. In this case, check the information in the front panel display.
- When you record the playback picture of this player on another VCR, etc., be sure to select ON SCREEN OFF. Otherwise, the display information is also recorded on the VCR.

Selecting the language of the on-screen display (English or Chinese)

- 1 Press SPECIAL MENU before you start playing. The following menu appears on the TV screen.

TV screen



You cannot select the item with this mark.

- 2 Press button 6. Each time you press the button 6 the displays alternate.

Using the Front Panel Display

You can check information about the disc using the front panel display.

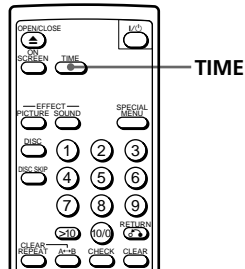

Checking the total number and playing time of the tracks

Press TIME before you start playing. The front panel display shows the current disc number, the total number of tracks, and total playing time.

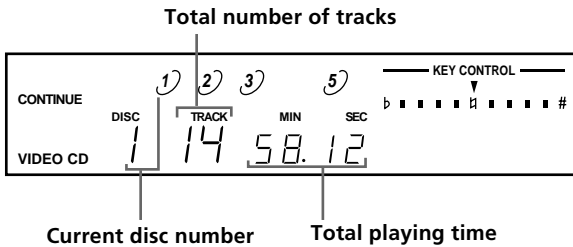

The information also appears when you press OPEN/CLOSE  to close the disc tray.

Notes on the disc number indications

- The red circle around a disc number indicates the disc is ready to be played.
- When all the tracks on a disc have been played, the semi-circle around the disc number disappears.
- When a disc compartment is recognized as empty, the semi-circled disc number disappears.

Display information while playing a disc

While playing an audio CD or a VIDEO CD without PBC functions, the front panel display shows the current disc number, track number, and playing time of the track.

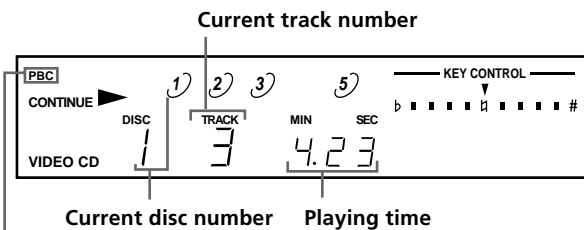

"PBC" is displayed while playing a VIDEO CD with PBC functions (page 25).

Checking the remaining time

Each time you press TIME while playing a disc, the display changes as shown in the chart below. Note that you cannot check the remaining time during PBC Playback (page 25).

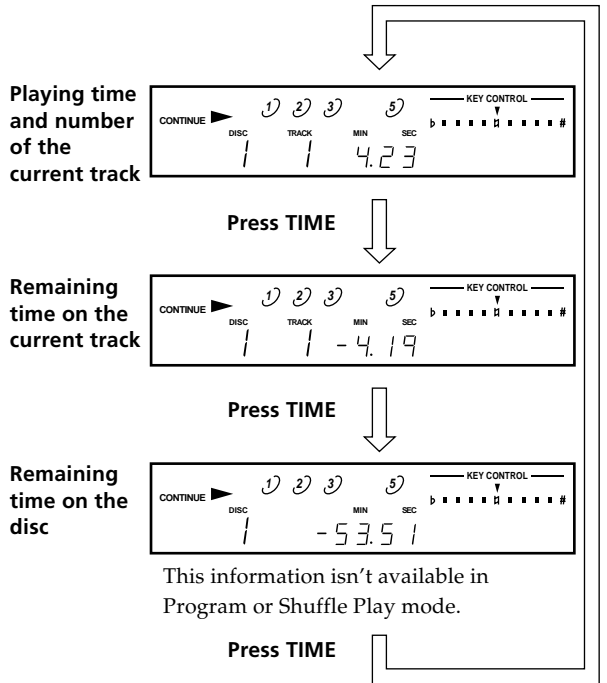

Replacing Discs While Playing a Disc

You can open the disc tray while playing a disc to check what discs are to be played next and replace discs without interrupting playback of the current disc.

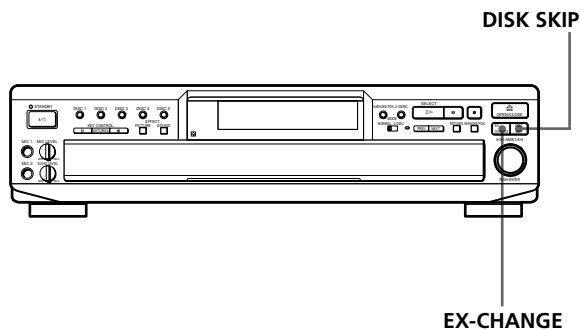

- 1 Press EX-CHANGE.
The disc tray opens and two disc compartments appear. Even if the player is playing a disc, it doesn't stop playing.
- 2 Replace discs in the compartments with new ones.
The player plays the disc in the left compartment after the current disc, and then the one in the right compartment.
- 3 Press DISK SKIP.
The disc tray turns and the other two disc compartments appear.
- 4 Replace discs in the compartments with new ones.
- 5 Press EX-CHANGE.
The disc tray closes.

Notes

- If the playback of the current disc ends while the disc tray is open, the player stops playing.
- In Shuffle Play mode (see page 20), tracks are reshuffled on the current disc, while the disc tray is open.
- In Program Play mode (see page 21), only the tracks on the current disc are played.
- Do not push the disc tray to close it in Step 5, as you may damage the player.

Locating a Specific Disc

You can locate any disc before or while playing a disc.

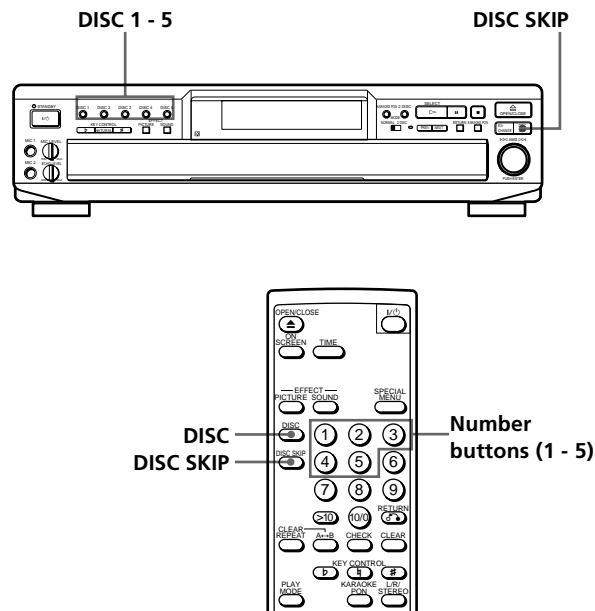

To locate	Press
The next disc	DISC SKIP
A specific disc directly	DISC 1 - 5 (or DISC and number button of the disc (1 - 5) on the remote)

Note

When you press DISC 1 - 5 (or DISC and number button of the disc (1 - 5) on the remote) before playing a disc, the player will automatically start playing the selected disc.

Playing Two Discs Consecutively

2 DISC mode can be used to playback two discs consecutively. In this mode, the player operates like a two-disc changer. This function is useful for playing pairs of CDs, such as those for movies.

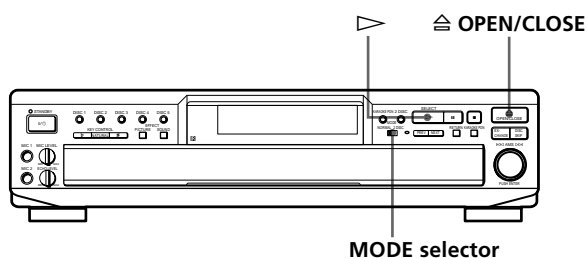

- 1 Set the MODE selector on the player to 2 DISC.
- 2 Press OPEN/CLOSE. The disc tray opens and two disc compartments (DISC 1 and DISC 2 only) appear.

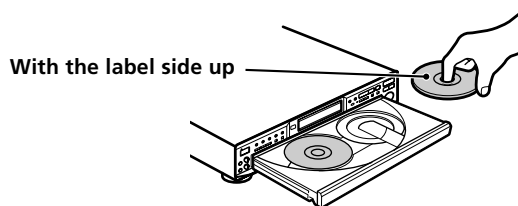

- 3 Place the discs into the trays. The disc on the left (DISC 1) is played first.
- 4 Press to start playback. When DISC 1 finishes, DISC 2 will automatically begin playing.

Notes

- If you select 2 DISC mode to play a video CD with the PBC functions, the player will automatically begin playing the disc with the PBC functions off (PBC OFF: see page 25).
- If you set the MODE selector to 2 DISC while a disc is playing in NORMAL mode, the player will stop playing the disc and will enter standby mode for DISC 1 operations. "no dISC" appears in the display when there is no disc in DISC 1 compartment.
- The DISC SKIP, EX-CHANGE and DISC 3 - 5 (or DISC and number button of the disc (3 - 5) on the remote) buttons do not operate in 2 DISC mode. Set the MODE selector on the player to NORMAL to play or remove discs in DISC 3 - 5 compartments.

Resuming Playback from the Point You Stopped a VIDEO CD (Resume Play)

The player memorizes the point you stopped a VIDEO CD and you can resume playback from that point. The player memorizes the point even when you turn off the player. You cannot start Resume Play if "RESUME" is not shown in the front panel display. Note that Resume Play is not available while playing an audio CD.

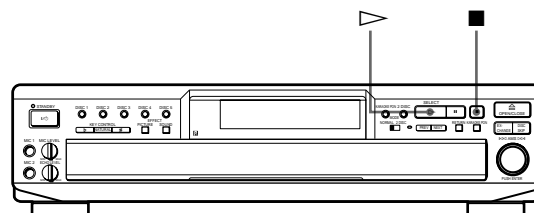

- 1 While playing a VIDEO CD, press to stop playback. "RESUME" appears in the front panel display. If "RESUME" doesn't appear, Resume Play is not available.
- 2 Press . The player starts playback from the point you stopped the VIDEO CD in Step 1.



To view from the beginning of the VIDEO CD

When "RESUME" appears in the front panel display, press , then press .

Notes

- Depending on where you stopped the VIDEO CD, the player may resume playback from a different point.
- The point at which you stopped playing is cleared when:
 - you press number buttons or PLAY MODE
 - you remove the VIDEO CD from the player
 - you unplug the AC power cord of the player
 - you press DISC 1 - 5 (or DISC and number button of the disc (1 - 5) on the remote)
 - you press DISC SKIP
 - you set the MODE selector to NORMAL or 2 DISC
- If you play a CD audio track in a VIDEO CD with PBC function (see page 25) and resume playback, the background picture may change to blue. However, this is not a malfunction.

Locating a Specific Track

You can quickly locate any scene or track while playing a disc using the JOG SELECTOR ◀◀/▶▶, PREV / NEXT buttons or number buttons.

Note that while playing a VIDEO CD with PBC functions, this function is available only during playback without PBC functions (PBC OFF, page 25).

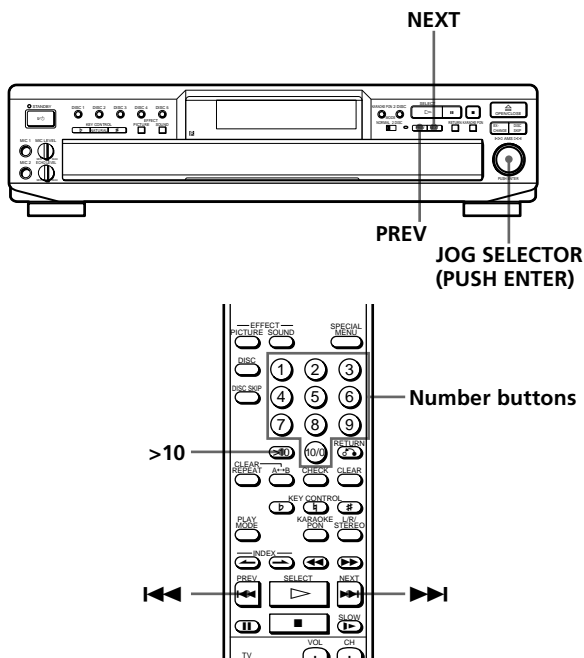

To locate	Press
The next or subsequent tracks (AMS)	NEXT or ▶▶ repeatedly, or turn JOG SELECTOR clockwise until you find the scene or track
The current or preceding tracks (AMS)	PREV or ◀◀ repeatedly, or turn JOG SELECTOR counterclockwise until you find the scene or track
A specific track directly	Number button of the track

💡 When you directly locate a track numbered over 10 with the remote

Press >10 on the remote first, then the corresponding number buttons. To enter "0," use button 10/0 on the remote.

Example: To play track number 30
Press >10 on the remote first, then 3 and 10/0 on the remote.

Note

During PBC Playback, JOG SELECTOR, PREV, NEXT, ◀◀ and ▶▶ buttons have different functions from the ones explained above.

Locating a Point by Elapsed Time (Time Search)



This function lets you use elapsed time as a guide to find a certain point on a VIDEO CD. To use Time Search function with VIDEO CDs with PBC function (Ver. 2.0 discs), see the explanation below. "Elapsed" means the time from the beginning of the disc and is not the playing time of the current track.

Time Search function is especially useful when playing discs that have only a few track divisions.

This function cannot be used during Digest Play (see page 17).

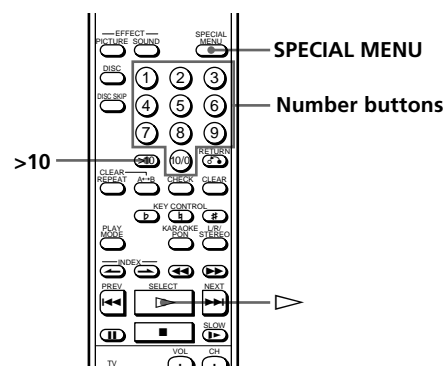

- 1 Press SPECIAL MENU while playing a disc or before you start playing.
The following menu appears on the TV screen.

TV screen



You cannot select the item with this mark.

- 2 Press button 2.
- 3 Press the number buttons to enter the time (in minutes) of the point that you want to locate. The entered time appears on the TV screen.
If you've made a mistake
Press CLEAR, then press the correct number button.
- 4 Press ▷.
Playback starts from the entered time.

To use Time Search function with VIDEO CDs with PBC function (Ver. 2.0 discs)

Do Steps 1 and 2 above before you start playing the VIDEO CD so that "PBC OFF" appears in the front panel display.

Locating a Particular Point in a Scene or Track



You can also locate a particular point in a scene or track while playing a disc.

During PBC Playback (page 25), this function is available only while playing moving pictures.

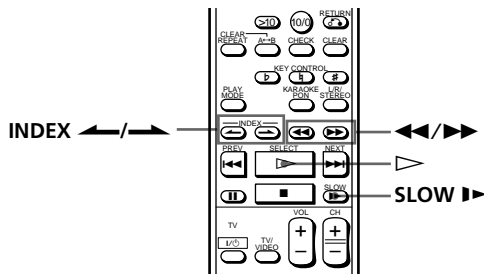
While playing an audio CD or a CD audio track in a VIDEO CD, changing the search speed while locating a point or Slow-motion Play is not available.



To locate a point	Press
While monitoring the picture or sound	▶▶ (forward) or ◀◀ (backward) repeatedly to select the speed (▶▶ or ◀◀ 1, ▶▶▶ or ◀◀◀ 2 or ▶▶▶▶ or ◀◀◀◀ 3). When you find the point, press ▷ to return to the normal speed. You will not hear the sound while playing a VIDEO CD. Note that you cannot change the search speed on audio CDs.
Slowly by observing the TV screen (Slow-motion Play)	SLOW ▶▶. You will not hear the sound during the operation. When you find the point, press ▷ to return to the normal speed.

 **If you want to change the playback speed during Slow-motion Play **

Press SLOW ▶▶ repeatedly until you find the playback speed you want. Three speeds are available: SLOW 1, SLOW 2 and SLOW 3. Each time you press the button, the indication changes as follows.



 **If "⌂" appears in the front panel display**

The disc has reached the end while you were pressing ▶▶. Press ◀◀ or ◀◀◀ to go back.

Note

While playing a VIDEO CD, the picture may be distorted during the search operation.

Locating a point using the index (Index Search)

There are two kinds of indexes: one is for audio CDs and the other is for VIDEO CDs. You can locate a point you want using the index.

Note that this function is available only for indexed discs. Also note that you cannot search indexes in different tracks.

While playing a track, press INDEX ◀ or ▶ repeatedly.

- To locate the current or preceding index numbers, press INDEX ◀.
- To locate the next or subsequent index numbers, press INDEX ▶.

Front panel display

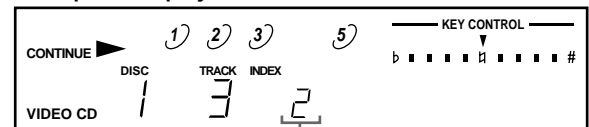

Index number

TV screen (when you press INDEX ◀ or ▶ while playing a VIDEO CD)

ON SCREEN 1 or 2 display mode

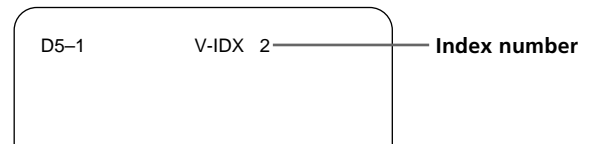

TV screen (while playing an audio CD)

ON SCREEN 1 or 2 display mode

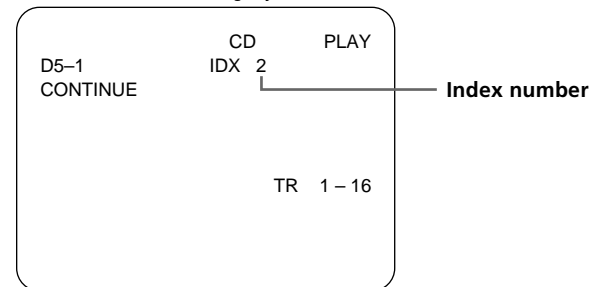

 **What is an index?**

It is the division of a track or disc into numbered sections. It allows you to easily locate a desired point on the disc. To determine whether or not a disc has an index, look at the disc's packaging.

Note

If there are no more indexes while playing a VIDEO CD, "CANNOT OPERATE NOW" appears on the TV screen and the player continues playing.

Locating by Observing Several Scenes at One Time (Digest Play)

This function is available only when the MODE selector is set to NORMAL and the disc tray is closed. You can locate the disc or scene you want by observing several still pictures at one time on the TV screen. Note that while playing a VIDEO CD with PBC functions, this function is available before you start playing or during playback without PBC functions (PBC OFF, page 25).

While playing a VIDEO CD, you will not hear the sound.

While playing an audio CD, you will only hear the sound.

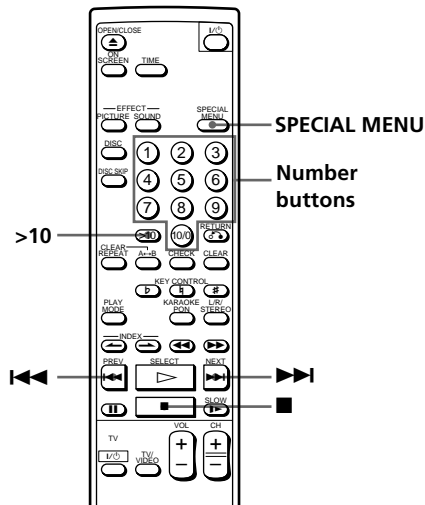

Specifying the number of still pictures

You can select either 9 or 12 of still pictures that appear on the TV screen during Disc Digest and Track Digest.

- 1 Press SPECIAL MENU while playing a disc or before you start playing. The following menu appears on the TV screen.

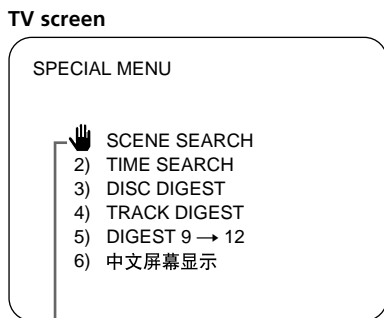

You cannot select the item with this mark.

- 2 Press button 5. Each time you press the button, the number toggles between 9 and 12. Select 9→12 for 9 still pictures; select 12→9 for 12 still pictures.

Locating the track you want on a disc (Disc Digest)

You can locate the track you want by observing the first picture of up to 9 or 12 tracks on the disc at one time on the TV screen.

- 1 Press SPECIAL MENU while playing a disc or before you start playing. The following menu appears on the TV screen.

TV screen



- 2 Press button 3. While playing a VIDEO CD, the TV screen shows still pictures of the first scenes of tracks 1 to 9 or 12 on the disc. While playing an audio CD, the beginnings of each track are played in sequence. → shows the track that the player is currently playing.

TV screen Current disc

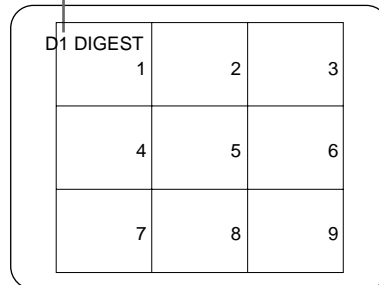

To view still pictures of the tracks numbered over 9 or 12

Press ►►. The TV screen shows still pictures of tracks 10 to 18 or 13 to 24.

If there are more tracks, "►►" is displayed on the upper right side of the TV screen.

To go back to the previous screen, press ◀◀.

(Continued)

- Press the number button to select the track.
The player starts playing from the selected track.
To select tracks numbered over 10 with the remote
Use the >10 button on the remote (see page 15).

To cancel Disc Digest

Press ■.

-  **During Disc Digest, you can start Disc Digest on another disc**

Press DISC SKIP.

Notes

- If you start Disc Digest before you start playing a VIDEO CD with PBC functions, the player automatically starts playing without PBC functions (PBC OFF, page 25).
- When you start Disc Digest in Shuffle or Program Play mode, the player automatically enters Continuous Play mode (page 7).

Locating the point you want in a track (Track Digest)

You can have the player divide a track into 9 or 12 sections. You can locate the point you want by viewing the first picture of each section at one time on the TV screen. This might be useful when you play a disc which is divided into few tracks, such as a movie.

- Press SPECIAL MENU while playing a disc or before you start playing.
The following menu appears on the TV screen.

TV screen



- Press button 4.
While playing a VIDEO CD, the player divides the track into 9 or 12 sections and the TV screen shows still pictures of each section in order.
While playing an audio CD, the player divides the track into 9 or 12 sections and plays the beginnings of each section in sequence. → shows the section that the player is currently playing.

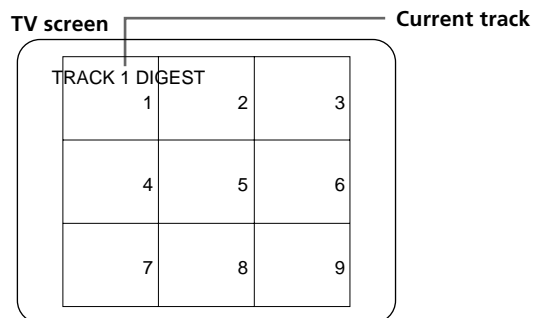

- Press the corresponding number button to select the point you want.
The player starts playing from the selected point.
The player may start playing from a point which is a little different from the one displayed during Track Digest.

To cancel Track Digest

Press ■.

 You can select a point which isn't displayed yet on the TV screen in Step 2

 During Track Digest, you can start Track Digest on another track

Press **◀◀** or **▶▶**.

Note that this function is not available in Shuffle or Program Play mode.

Notes

- If you start Track Digest before you start playing a VIDEO CD with PBC functions, the player automatically starts playing without PBC functions (PBC OFF, page 25).
- If you start Track Digest before you start playing in Shuffle or Program Play mode, " NO SELECTION" appears on the TV screen.
- When a track is shorter than about 40 seconds, the player may divide the track into less than 9 or 12 sections.

Playing Repeatedly

You can play all the tracks, a single track or a specific portion repeatedly.

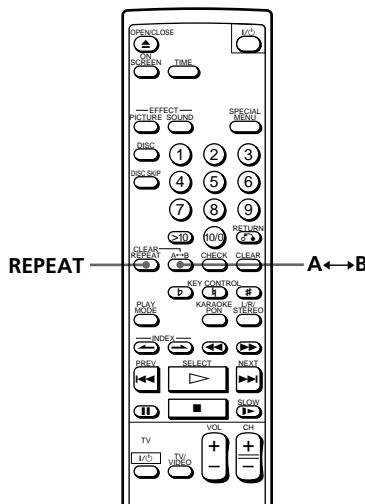

In Shuffle or Program Play mode, the player repeats the track in the shuffled or programmed order. During PBC Playback (page 25), this function is not available.

Press REPEAT while playing a disc.

"REPEAT" appears in the front panel display. The player repeats the discs/tracks as follows:

When the disc is played in	The player repeats
Continuous Play (page 7)	All the tracks on all discs
Shuffle Play (page 20)	All the tracks on all discs in random order
Select Shuffle Play (page 20)	All the tracks on the selected discs in random order
Program Play (page 21)	The same program

To cancel Repeat Play

Press REPEAT repeatedly until "REPEAT" disappears from the front panel display.

(Continued)

Repeating the current track

You can repeat only the current track in Continuous Play mode (page 7).

While the track you want is being played, press REPEAT repeatedly until "REPEAT 1" appears in the front panel display.

To cancel repeating the current track
Press REPEAT repeatedly until "REPEAT 1" disappears from the front panel display.

Repeating a specific portion (A↔B Repeat)

You can play a specific portion in a track repeatedly. This might be useful when you want to memorize lyrics. Note that you cannot repeat a portion extending to two tracks. During PBC Playback (page 25), A↔B Repeat may not be available depending on scenes.

- 1 While playing a disc, press A↔B when you find the starting point (point A) to be played repeatedly.
"A-" of "REPEAT A-" flashes in the front panel display.
- 2 When you reach the ending point (point B), press A↔B again.
"REPEAT A-B" appears. The player plays this specific portion repeatedly.

To cancel A↔B Repeat
Press REPEAT.

- 💡 When you want to restart from the starting point A
Press ▷ during A↔B Repeat.

Playing in Random Order (Shuffle Play)

You can have the player "shuffle" tracks and play in a random order. The player shuffles all the tracks on all discs.

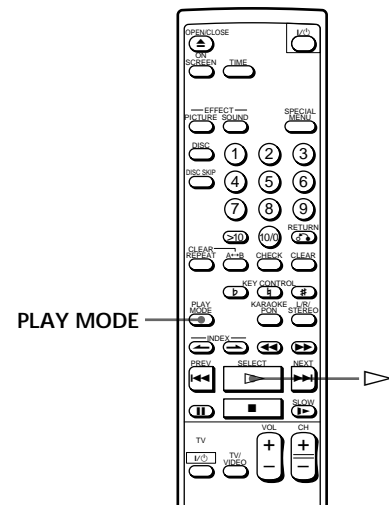

- 1 Press PLAY MODE repeatedly until "SHUFFLE" appears in the front panel display.
- 2 Press ▷ to start Shuffle Play.
The  indication appears while the player is "shuffling" the tracks.

To cancel Shuffle Play
Press PLAY MODE repeatedly until "CONTINUE" appears in the front panel display.

- 💡 You can start Shuffle Play while playing in Continuous Play mode
Press PLAY MODE repeatedly until "SHUFFLE" appears in the front panel display. Shuffle Play starts from the current track.

- 💡 You can specify discs during Shuffle Play (Select Shuffle Play)
You can specify discs before or during Shuffle Play, and the tracks on the specified discs are played in a random order.
Press DISC 1 - 5 (or DISC and number button of the disc (1 - 5) on the remote) to specify the discs after Step 1. Semi-circles appear around the specified disc numbers in the front panel display. To cancel the selected discs, press DISC 1 - 5 (or DISC and number button of the disc (1 - 5) on the remote) again. The semi-circles disappear.

Note
If you play a VIDEO CD with PBC functions in Shuffle Play mode, you cannot use the PBC functions.

Creating Your Own Program (Program Play)

You can arrange the order of the tracks on the discs and create your own program. The program can contain up to 24 tracks.

If you set the MODE selector to NORMAL or 2 DISC, the program is cleared.

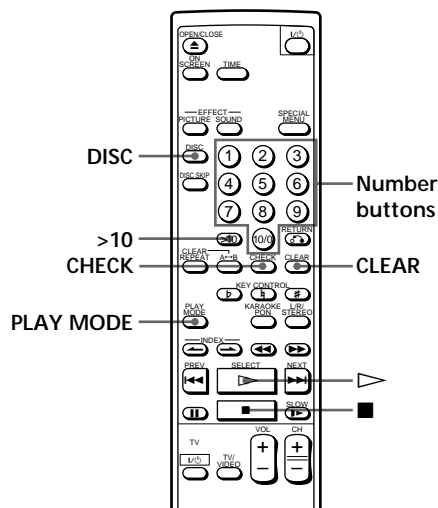
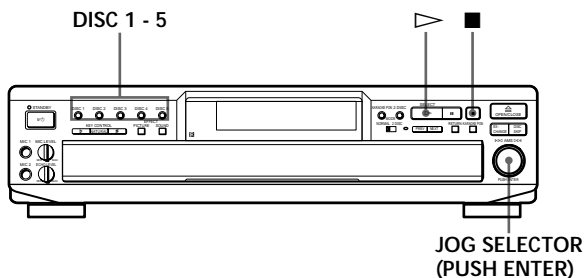

1 Press PLAY MODE on the remote repeatedly until "PROGRAM" appears in the front panel display.

2 Press DISC 1 - 5 (or DISC and number button of the disc (1 - 5) on the remote) to select the disc.

3 Select the tracks you want to program.
On the remote

Press the number buttons of the tracks you want to program in the order you want.

Example: To program the tracks in the order 2, 8, 5
Press the number buttons 2 → 8 → 5.

To program a track numbered over 10, use the >10 button (see page 15).

On the player

With playback stopped, turn JOG SELECTOR until the number of the track you want to program appears in the front panel display. Then press JOG SELECTOR.

Last programmed track Total playing time

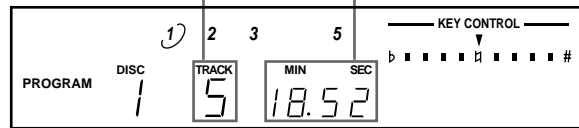

If you've made a mistake

Press CLEAR on the remote, then press the correct number button.

4 To program other discs or tracks, do the following:

To program	Repeat Step(s)
Other tracks on the same disc	3
Other tracks on other discs	2 and 3

5 Press ▷ to start Program Play.

To cancel Program Play

Press PLAY MODE on the remote repeatedly until "CONTINUE" appears in the front panel display. (When you want to play a VIDEO CD with PBC functions, be sure to press PLAY MODE repeatedly until "PROGRAM" disappears from the front panel display.)

You can insert a pause as one step

During programming, press || to insert a pause. The total playing time is reset to "0.00."

When playing a program which contains a pause, the player pauses at the step in which a pause is programmed, until you press || or ▷. This might be useful when you record a program on both sides of a tape.

You can check the contents of the program during programming on the TV screen

If you press ON SCREEN on the remote to select ON SCREEN OFF display mode, you won't see this information (pages 10 and 11).

You can create your program while checking the disc labels

While the disc tray is open, follow Steps 1 to 5 pressing DISC SKIP to check the disc labels.

The program remains even after the Program Play ends

When you press ▷, you can play the same program again.

(Continued)

Notes

- If you play a VIDEO CD with PBC functions in Program Play mode, you cannot use PBC functions (page 25).
- If the total playing time exceeds 100 minutes, "TOTAL - - : - -" appears on the TV screen.
- If you program more than 24 tracks, "FULL" appears on the TV screen.

Checking the track order



You can check your program before or after you start playing.

Press CHECK on the remote.

Each time you press this button, the front panel display shows the disc and track number of each step in the programmed order. After the last step in the program, the front panel display shows "End" and returns to the original display. If you check the order after you start playing, the front panel display shows the steps from the current play position.

Changing the track order

You can change your program before you start playing.

To	Press
Erase a step 	CHECK until the track or disc you don't want appears in the display, then press CLEAR.
Erase the last step in the program 	CLEAR. Each time you press this button, the last track and disc are cleared.
Add steps to the end of the program	DISC 1 - 5 (or DISC and number button of the disc (1 - 5) on the remote) and number buttons of the tracks to be added.
Change the whole program completely	■. Create a new program following the programming procedure.

Enjoying Picture Effects

You will get a clear-cut picture by emphasizing the outline of the pictures without increasing noise on the picture or you can enjoy a picture which luminance is reduced just like the picture on the movie theater screen.

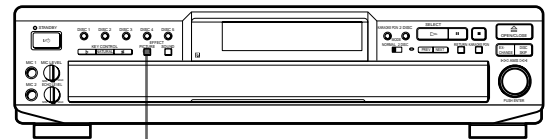

EFFECT PICTURE

Getting a clear-cut picture (Active Picture)

Press EFFECT PICTURE repeatedly until "ACTIVE" appears in the front panel display.

Getting a movie-theater-like picture (Theater Picture)

Press EFFECT PICTURE repeatedly until "THEATER" appears in the front panel display.

To cancel the picture effect

Press EFFECT PICTURE repeatedly until "ACTIVE" or "THEATER" disappears from the front panel display.

Note

The Active Picture and Theater Picture functions are not available while playing an audio CD.

Enjoying Sound Effects

You can play a disc with one of two acoustic atmospheres: M(ega).BASS or EX(tra).WIDE.

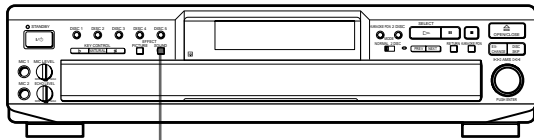

EFFECT SOUND

Press EFFECT SOUND repeatedly until the desired effect appears in the front panel display.

Effect mode	Atmosphere
M.BASS	Emphasizes the bass
EX.WIDE	Provides a greater sense of expanse

To cancel the sound effect

Press EFFECT SOUND repeatedly until "M. BASS" or "EX. WIDE" disappears from the front panel display.

Notes

- The Karaoke Pon function automatically turns off when the EX.WIDE sound effect is turned on.
- We recommend that you increase the volume when using the M.BASS sound effect.

Switching the Sound

You can select the sound from the right or left channel and listen to the sound of the selected channel through both the right and left speakers. In this case, the sound loses the stereo effect.

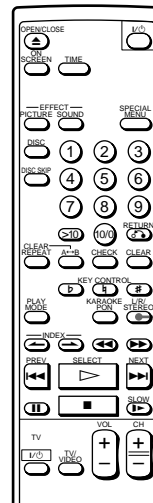

L/R/STEREO

Press L/R/STEREO while playing a disc.

Each time you press the button, the indication and the sound from the speakers change as follows:

Press	Indication*	You will hear
Once	MONO L	The sound of the left channel
Twice	MONO R	The sound of the right channel
Three times	STEREO**	The standard stereo sound

* When you select ON SCREEN OFF display mode, check the indication on the front panel display.

** This indication doesn't appear in the front panel display.

Controlling the TV with the Supplied Remote

You can control Sony TVs with the  mark using the supplied remote.

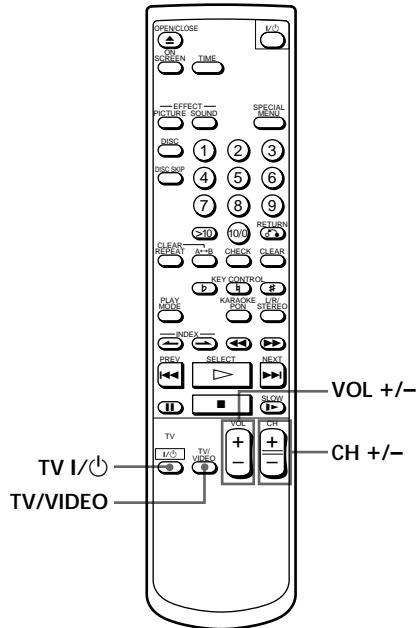

Press	You can
TV I/ON	Turn on or off the TV
TV/VIDEO	Select the input source to the TV
VOL +/-	Adjust the volume of the TV
CH +/-	Change the channel of the TV

Playing Karaoke with Any Stereo Discs (Karaoke Pon)

You can enjoy karaoke with a stereo-recorded disc, even if it is a non-karaoke disc, by reducing the singer's voice.

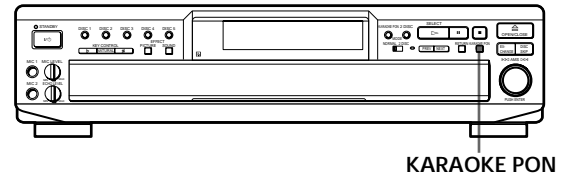

Press KARAOKE PON.

The indicator on the KARAOKE PON button lights and "K.PON" appears on the TV screen.

This reduces the singer's voice so that you can enjoy karaoke. However, this also reduces the stereo effect.

To cancel Karaoke Pon

Press KARAOKE PON again. The indicator goes off.

 **When you use Karaoke Pon**
Use stereo-recorded discs.

Notes

- Karaoke Pon may not work well for the following cases:
 - Monaural-recorded discs (The accompaniment is also reduced.)
 - Only a few instruments are playing in the stereo-recorded disc
 - A duet is being played
 - The disc has strong echoes or chorus
 - The singer's voice on the disc deviates from the center
 - Multiplex discs
- When you select ON SCREEN OFF display mode, no information is shown on the TV screen.
- When you turn on the Karaoke Pon function, EX.WIDE sound effect turns off automatically.
- Some CDs may generate some noise when the Karaoke Pon function is first turned on.

Playing VIDEO CDs with PBC Functions (PBC Playback)

When playing VIDEO CDs with PBC functions (Ver. 2.0 discs), you can enjoy playing simple interactive software, software with search functions, etc. PBC Playback allows you to play VIDEO CDs interactively, following the menu screen on the TV screen.

On this player, you can use the number buttons, JOG SELECTOR, PREV, NEXT and RETURN during PBC Playback.

Also refer to the instructions supplied with the disc, as the operating procedure may differ according to the VIDEO CD.

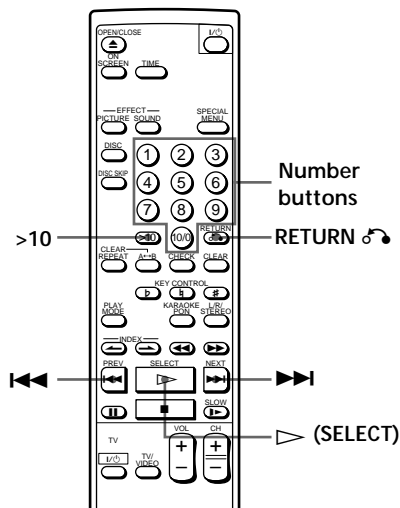
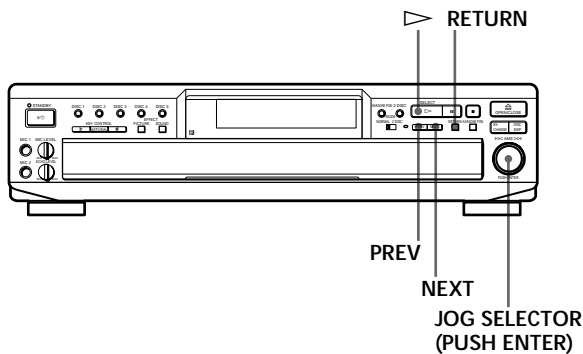

1 Start playing a VIDEO CD with PBC functions, following Steps 1 through 5 in “Playing a VIDEO CD” on page 7.

The menu screen appears on the TV screen and “SELECT” flashes.

2 Select the item number you want.

On the remote

Press the number button of the item you want. When you want to select an item number over 10, press >10 on the remote first, then the corresponding number buttons. To enter “0,” use button 10/0 on the remote.

Exmample: To select the item number 30

Press >10 on the remote first, then 3 and 10/0 on the remote.

On the player

Turn JOG SELECTOR to select the item number, then press JOG SELECTOR.

3 Follow the instructions on the menu screen for interactive operations.

When	Do the following
Selecting the item	Turn JOG SELECTOR on the player to select the item number, then press JOG SELECTOR. Press number button of the item you want on the remote.
“SELECT” is flashing on the TV screen while playing moving pictures	In this case, you can go to another scene even while playing moving pictures. Turn JOG SELECTOR then press JOG SELECTOR on the player, or press the number button of the item you want on the remote.
Going back to the menu screen	Press RETURN, PREV or NEXT. (Also refer to the instructions supplied with the disc, as the operating procedure may differ according to the VIDEO CD.)

When “ CANNOT OPERATE NOW” appears on the TV screen

You’ve pressed an invalid button. Press the correct button, following the instructions on the menu screen.

To cancel PBC Playback of a VIDEO CD with PBC functions and play the disc in Continuous Play mode There are two ways.

- Before you start playing, select the track you want with ◀◀ or ▶▶, then press ▷.
- Before you start playing, select the track number using the number buttons.

“PBC OFF” and “CONTINUE” appear in the front panel display and the player starts Continuous Play. You cannot play still pictures such as a menu screen.

Note

When you scan the still pictures in the Slide Show, the last picture may not appear.

(Continued)

Example of PBC Playback

This is an example of PBC Playback. Also refer to the instructions supplied with the disc, as the operating procedure may differ according to the VIDEO CD.

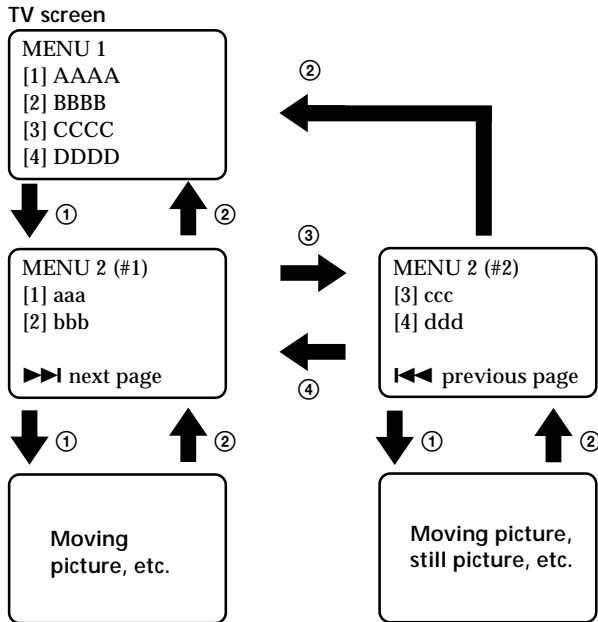

- ① To select the item:
Press the number button of the item you want.
- ② To go to the preceding menu:
Press \curvearrowright RETURN.
- ③ To go to the next page of the menu:
Press $\blacktriangleright\blacktriangleright$.
- ④ To go back to the preceding page of the menu:
Press $\blacktriangleleft\blacktriangleleft$.

Locating Scenes Directly Using the Scene Numbers (Scene Search)

On VIDEO CDs with PBC functions, the menu screens, moving pictures and still pictures are divided into "scenes" and each scene is assigned with a scene number.

You can check the current scene number by displaying it on the TV screen during playback (see page 10). Be sure to memorize the scene number from which you want to start playing.

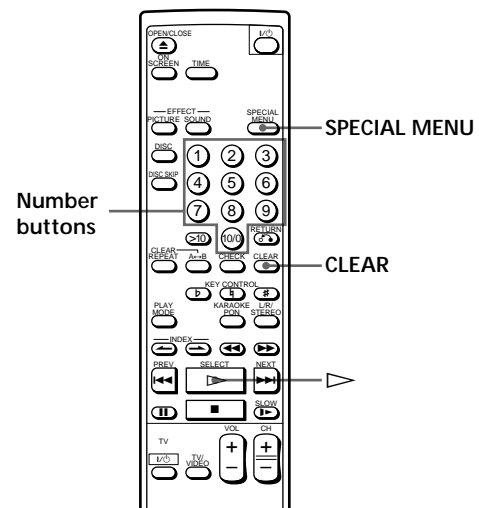

- 1 Press **SPECIAL MENU** before you start playing or while playing a disc.
The following menu appears on the TV screen.

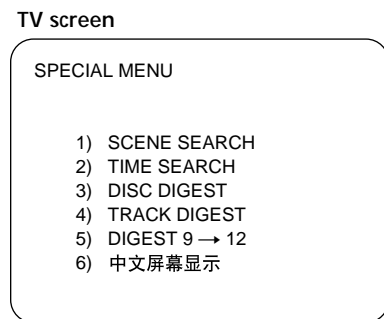

- 2 Press button 1.
"SCENE -" and the scene numbers appear on the TV screen.

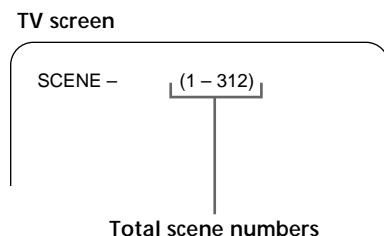

- 3** Press the number buttons (1 - 10/0) to select the scene.

To enter "0", use the button 10/0.

Example: To select scene number 103

Press 1, then 10/0 and 3.

The selected scene number appears on the TV screen.

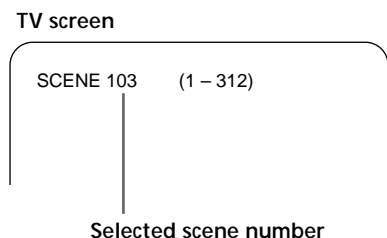

If you've made a mistake

Press CLEAR, then press the correct number button.

- 4** Press \triangleright to start playing from the selected scene. The player automatically starts PBC Playback (page 25).

-  You can check the scene number while playing a disc. Press ON SCREEN repeatedly to select ON SCREEN 2 display mode (see page 10). The scene numbers appear on the upper left side of the TV screen.

Notes

- Some discs don't allow you to start playing from a particular scene. In this case, when you do the task before you start playing, the player starts playing from scene 1. When you do the task while playing a disc, the player starts playing from the current scene.
- Some discs don't display the selected scene on the TV screen.
- When you select ON SCREEN OFF display mode, no information is shown on the TV screen.

Precautions

On safety

- Caution — The use of optical instruments with this product will increase eye hazard.
- Should any solid object or liquid fall into the cabinet, unplug the player and have it checked by qualified personnel before operating it any further.

On power sources

- Before operating the player, check that the operating voltage of the player is identical with your local power supply. The operating voltage is indicated on the nameplate at the rear of the player.
- The player is not disconnected from the AC power source (mains) as long as it is connected to the wall outlet, even if the player itself has been turned off.
- If you are not going to use the player for a long time, be sure to disconnect the player from the wall outlet. To disconnect the AC power cord (mains lead), grasp the plug itself; never pull the cord.
- AC power cord must be changed only at the qualified service shop.

On placement

- Place the player in a location with adequate ventilation to prevent heat build-up in the player.
- Do not place the player on a soft surface such as a rug that might block the ventilation holes on the bottom.
- Do not place the player in a location near heat sources, or in a place subject to direct sunlight, excessive dust or mechanical shock.

On operation

If the player is brought directly from a cold to a warm location, or is placed in a very damp room, moisture may condense on the lenses inside the player. Should this occur, the player may not operate properly. In this case, remove the disc and leave the player turned on for about an hour until the moisture evaporates.

On adjusting volume

Do not turn up the volume while listening to a portion with very low level inputs or no audio signals. If you do, the speakers may be damaged when a peak level portion is played.

On cleaning

Clean the cabinet, panel and controls with a soft cloth slightly moistened with a mild detergent solution. Do not use any type of abrasive pad, scouring powder or solvent such as alcohol or benzene.

On transportation

See page 6.

On disc tray

Do not pull or push the disc tray forcefully by hand. It may damage the player.

If you have any questions or problems concerning your player, please consult your nearest Sony dealer.

Notes on Discs

On handling discs

- To keep the disc clean, handle the disc by its edge. Do not touch the surface.
- Do not stick paper or tape on the disc.
If there is glue (or a similar substance) on the disc, remove the glue completely before using the disc.

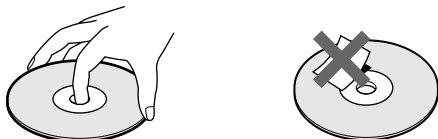

Do not stick

- Do not expose the disc to direct sunlight or heat sources such as hot air ducts, or leave it in a car parked in direct sunlight as there can be considerable rise in temperature inside the car.
- After playing, store the disc in its case.
- Only regular circular discs can be used in this VIDEO CD player. Irregularly shaped discs, such as star- or heart-shaped discs, may damage the player.

On cleaning

- Before playing, clean the disc with a cleaning cloth. Wipe the disc from the center out.

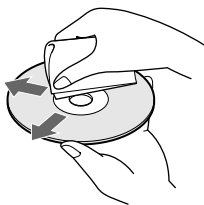

- Do not use solvents such as benzene, thinner, commercially available cleaners or anti-static spray intended for vinyl LPs.

Troubleshooting

If you experience any of the following difficulties while using the player, use this troubleshooting guide to help you remedy the problem. Should any problem persist, consult your nearest Sony dealer.

There's no sound.

- ➔ Check that the player is connected securely.
- ➔ Make sure you operate the TV or the amplifier correctly.
- ➔ Make sure you select the CD player position on the amplifier.

There's no picture.

- ➔ Check that the player is connected securely.
- ➔ Make sure you operate the TV correctly.
- ➔ Make sure you set the COLOR SYSTEM switch correctly, according to your TV.

The disc doesn't play.

- ➔ There's no disc inside ("no DISC" appears). Insert a disc.
- ➔ Insert the disc with the label side up on the disc tray correctly.
- ➔ Clean the disc (see this page).
- ➔ Moisture has condensed inside the player. Remove the disc and leave the player turned on for about an hour (see page 27).

The sound loses stereo effect.

- ➔ "MONO R" or "MONO L" appears in the front panel display (see page 23).

The remote doesn't function.

- ➔ Remove the obstacles in the path of the remote and the player.
- ➔ Point the remote at the remote sensor  on the player.
- ➔ Replace all the batteries in the remote with new ones if they are weak.

There's no sound from the microphone.

- ➔ Switch the microphone on.
- ➔ Turn the MIC LEVEL controls clockwise.

Howling occurs.

- ➔ Move the microphone away from the speakers.
- ➔ Lower the volume.
- ➔ Lower the microphone volume or echo level.

The player doesn't play from the first track when playing a VIDEO CD without PBC functions or an audio CD.

- ➔ Press PLAY MODE repeatedly until "CONTINUE" appears in the front panel display, then press .

"ERROR" is displayed.

- ➔ You have placed a disc into the compartment for the disc being played. Remove the disc and close the disc tray.

Specifications

VIDEO CD player

Laser	Semiconductor laser ($\lambda=780\text{nm}$) Emission duration: continuous
Laser output	MAX 44.6 μW * This output is the value measured at a distance of 200 mm from the objective lens surface on the Optical Pick-up Block with 7 mm aperture.
Wavelength	780 - 790 nm
Signal format system	NTSC, PAL
Frequency response	20 Hz to 20 kHz ± 1.0 dB

Outputs

	Jack type	Maximum output level	Load impedance
AUDIO OUT	Phono jacks	1.43 V (at 50 kilohms)	Over 10 kilohms
VIDEO OUT	Phono jack	1 Vp-p	75 ohms, unbalanced, sync negative

Inputs

	Jack type	Maximum input level	Load impedance
MIC 1, MIC 2	Phone jack	100 mVp-p	600 ohms

General

Power requirements	110 - 120 V or 220 - 240 V AC, adjustable, 50/60 Hz
Power consumption	24 W
Dimensions (approx.) (w/h/d)	430 \times 110 \times 398 mm incl. projecting parts
Mass (approx.)	5.3 kg

Supplied accessories

Audio and video connecting cord (1)
Remote commander (remote) RMT-C98V (1)
Sony R6 (size AA) batteries (2)

Design and specifications are subject to change without notice.

Glossary

Auto Pause

Automatic pause function that works according to the signal encoded on the disc during VIDEO CD playback. In this case, "AUTO **||**" appears in the front panel display. If the player doesn't resume play for a long time, press **||** or **▷** to resume play manually.

PBC Playback

Playback using the menu screens recorded on VIDEO CDs with PBC functions. You can enjoy simple interactive operations using the PBC Playback function.

Playback Control (PBC)

Signals encoded on VIDEO CDs (Version 2.0) to control playback.

By using menu screens recorded on VIDEO CDs with PBC functions, you can enjoy playing simple interactive software, software with search functions, and so on.

When you insert a VIDEO CD with PBC functions on this player, "PBC" appears in the front panel display.

Track

Sections of a picture or a music piece on a disc. Each track is assigned with a track number to locate the track you want.

VIDEO CD

A compact disc that contains moving pictures. The picture information uses the MPEG 1 format, one of the world wide standards of digital compact technology. The picture information is compressed about 120 times. Consequently, a 12 cm VIDEO CD can contain up to 74 minutes of moving pictures.

VIDEO CDs also contain compact audio information. Sounds outside the range of human hearing are compressed while the sounds we can hear aren't compressed. VIDEO CDs can hold 6 times the audio information of conventional audio CDs.

There are 2 versions of VIDEO CDs.

- Version 1.1: You can play only moving pictures and sounds.
- Version 2.0: You can play high-resolution still pictures and enjoy PBC functions.

This player conforms to both versions.

Index

A, B

- A-B repeat 20
- Adjusting
 - echo level 9
 - microphone volume 9
 - volume 7
- AMS 15
- Auto Pause 29
- Automatic Music Sensor. See AMS

C

- Color system switch 6
- Connecting 5
- Continuous play 7

D

- Digest Play 17
- Disc Digest 17
- Display
 - front panel display 12
 - on-screen display 10

E

- Echo 9

F, G

- Front panel display 12

H

- Handling CDs 28
- Hooking up 5

I, J

- Index 16
- Index Search 16

K

- Karaoke Pon 24
- Key control 9

L, M, N

- Locating
 - a specific disc 13
 - a specific point 16
 - a specific track 15
 - by monitoring 16
 - directly 15
 - using AMS 15
 - using index 16

O

- On-screen display 10

P, Q

- PBC functions 25, 29
- PBC Playback 25, 29
- Picture effects 22
- Playback
 - Continuous Play 7
 - Program Play 21
 - Repeat Play 19
 - Shuffle Play 20
 - two discs consecutively 14
- Program
 - changing 22
 - checking 22

R

- Remaining time 12
- Remote control 4, 24
- Repeating 19
- Replacing discs while playing a disc 13
- Resume Play 14

S

- Scene 26
- Scene Search 26
- Searching. See Locating
- Shuffle Play 20
- Slow-motion Play 16
- Sound effects 23
- Standby mode 8
- Switching the sound 23

T

- Total playing time 12
- Track Digest 18
- Troubleshooting 28

U

- Unpacking 4
- Using microphone 9

V, W, X, Y, Z

- VIDEO CDs 4, 7, 29
- Voltage selector 6

Names of controls

Buttons

- A↔B 20
- CHECK 22
- CLEAR 21, 22, 27
- DISC SKIP 7, 8, 13, 18, 21
- DISC 1 - 5 8 - 9, 13, 20 - 22
- EFFECT PICTURE 22
- EFFECT SOUND 23
- EX-CHANGE 13
- INDEX ◀/▶ 16
- KARAOKE PON 24
- KEY CONTROL
 - b, NATURAL, # 9
- L/R/STEREO 23
- Number 9, 15, 21, 22, 25, 27
- ON SCREEN 10, 27
- ⊞ OPEN/CLOSE 6 - 8, 14
- PLAY MODE 20, 21
- REPEAT 19, 20
- ↶ RETURN 25
- ▷ (SELECT) 25
- SLOW ▶▶ 16
- SPECIAL MENU 11, 15, 17, 18, 26
- TIME 12
- ▷ 7, 8, 14, 15, 20, 21, 25, 26, 29
- ⏸ 8, 21, 29
- 8, 14, 18, 22
- ◀◀/▶▶ 8, 15 - 17, 19, 25
- ◀◀/▶▶ 17
- >10 9, 15, 18, 21, 25

Switch and Selector

- MODE (NORMAL/2 DISC) 14
- I/⏻ 6, 7

Control

- ECHO LEVEL 9
- MIC LEVEL 9

Jack

- MIC 1, MIC 2 9

Others

- Disc tray 7, 13, 14
- Front panel display 12
- 4, 24

Sony  line

<http://www.world.sony.com/>

Sony Corporation Printed in China
