

Mini Hi-Fi Component System

Operating Instructions

Owner's Record

The model and serial numbers are located at the rear of the unit. Record these numbers in the spaces provided below. Refer to them whenever you call upon your Sony dealer regarding this product.

Model No. _____ Serial No. _____



MDLP

DHC-MD595

WARNING

To prevent fire or shock hazard, do not expose the unit to rain or moisture.

To avoid electrical shock, do not open the cabinet. Refer servicing to qualified personnel only.

Do not install the appliance in a confined space, such as a bookcase or built-in cabinet.

US and foreign patents licensed from Dolby Laboratories.

CLASS 1 LASER PRODUCT
LUOKAN 1 LASERLAITE
KLASS 1 LASERAPPARAT

This appliance is classified as a CLASS 1 LASER product. The CLASS 1 LASER PRODUCT MARKING is located on the rear exterior.

The following caution label is located inside of the unit.



AF46

IN NO EVENT SHALL SELLER BE LIABLE FOR ANY DIRECT, INCIDENTAL OR CONSEQUENTIAL DAMAGES OF ANY NATURE, OR LOSSES OR EXPENSES RESULTING FROM ANY DEFECTIVE PRODUCT OR THE USE OF ANY PRODUCT.

NOTICE FOR THE CUSTOMERS IN THE U.S.A.

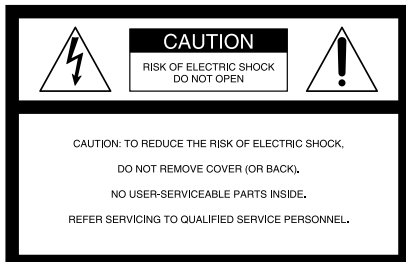

This symbol is intended to alert the user to the presence of uninsulated “dangerous voltage” within the product’s enclosure that may be of sufficient magnitude to constitute a risk of electric shock to persons.



This symbol is intended to alert the user to the presence of important operating and maintenance (servicing) instructions in the literature accompanying the appliance.

CAUTION

The use of optical instruments with this product will increase eye hazard.

INFORMATION

This equipment has been tested and found to comply with the limits for a Class B digital device, pursuant to Part 15 of the FCC Rules. These limits are designed to provide reasonable protection against harmful interference in a residential installation. This equipment generates, uses, and can radiate radio frequency energy and, if not installed and used in accordance with the instructions, may cause harmful interference to radio communications. However, there is no guarantee that interference will not occur in a particular installation. If this equipment does cause harmful interference to radio or television reception, which can be determined by turning the equipment off and on, the user is encouraged to try to correct the interference by one or more of the following measures:

- Reorient or relocate the receiving antenna.
- Increase the separation between the equipment and receiver.
- Connect the equipment into an outlet on a circuit different from that to which the receiver is connected.
- Consult the dealer or an experienced radio/TV technician for help.

CAUTION

You are cautioned that any changes or modifications not expressly approved in this manual could void your authority to operate this equipment.

Note to CATV system installer:

This reminder is provided to call the CATV system installer’s attention to Article 820-40 of the NEC that provides guidelines for proper grounding and, in particular, specifies that the cable ground shall be connected to the grounding system of the building, as close to the point of cable entry as practical.

NOTICE FOR THE CUSTOMERS IN CANADA

CAUTION

TO PREVENT ELECTRIC SHOCK, DO NOT USE THIS POLARIZED AC PLUG WITH AN EXTENSION CORD, RECEPTACLE OR OTHER OUTLET UNLESS THE BLADES CAN BE FULLY INSERTED TO PREVENT BLADE EXPOSURE.

Table of Contents

Getting Started

Step 1: Hooking up the system	4
Step 2: Setting the time	6
Step 3: Presetting radio stations	7

Basic Operations

Playing a CD	9
Recording a CD on an MD	
— CD-MD Synchro Recording	10
Playing an MD	11
Listening to the radio	
— Preset Tuning	12
Recording from the radio	
— Manual Recording	13

The CD Player

Playing CD tracks repeatedly	
— Repeat Play	15
Playing CD tracks in random order	
— Shuffle Play	15
Programming CD tracks	
— Program Play	16
Using the display	17
Labeling a CD — Disc Memo	18

The MD Deck — Play

Playing MD tracks repeatedly	
— Repeat Play	20
Playing MD tracks in random order	
— Shuffle Play	21
Programming MD tracks	
— Program Play	21
Using the display	23

The MD Deck — Recording

Before you start recording	24
Recording your favorite CD tracks	
on an MD	
— CD-MD Synchro Recording	25
Recording a CD on an MD at high speed	
— High-Speed CD-MD Synchro	
Recording	26
Recording the current track — Rec It	28
Recording for long times	28
Recording on an MD manually	
— Manual Recording	30

Starting recording with 6 seconds of	
prestored audio data	
— Time Machine Recording	31
Marking track numbers	32
Making a space between tracks 3 seconds	
long — Smart Space	34
Adjusting the recording level	36

The MD Deck — Editing

Before you start editing	37
Labeling an MD — Name Function	38
Erasing recordings — Erase Function	40
Moving recorded tracks	
— Move Function	43
Dividing recorded tracks	
— Divide Function	45
Combining recorded tracks	
— Combine Function	46
Undoing the last edit	
— Undo Function	48
Changing the recorded level after	
recording — S.F Edit Function	49

Sound Adjustment

Reinforcing the bass sound — DBFB	52
Selecting the Preset Equalizer menu	52

Other Features

Labeling the preset stations	
— Station Name	53
Using the Radio Data System (RDS)*	54
Falling asleep to music — Sleep Timer ..	55
Waking up to music — Daily Timer	55
Timer recording radio programs	57

Connecting optional components

Connecting optional A/V components	59
Connecting external antennas	60

Additional Information

Precautions	61
System limitations of MDs	62
Troubleshooting	64
Self-diagnosis Display	67
Specifications	70
Parts descriptions for the remote	71
Index	74

* European model only

Step 1: Hooking up the system

Perform the following procedure **1** to **4** to hook up your system using the supplied cords and accessories.

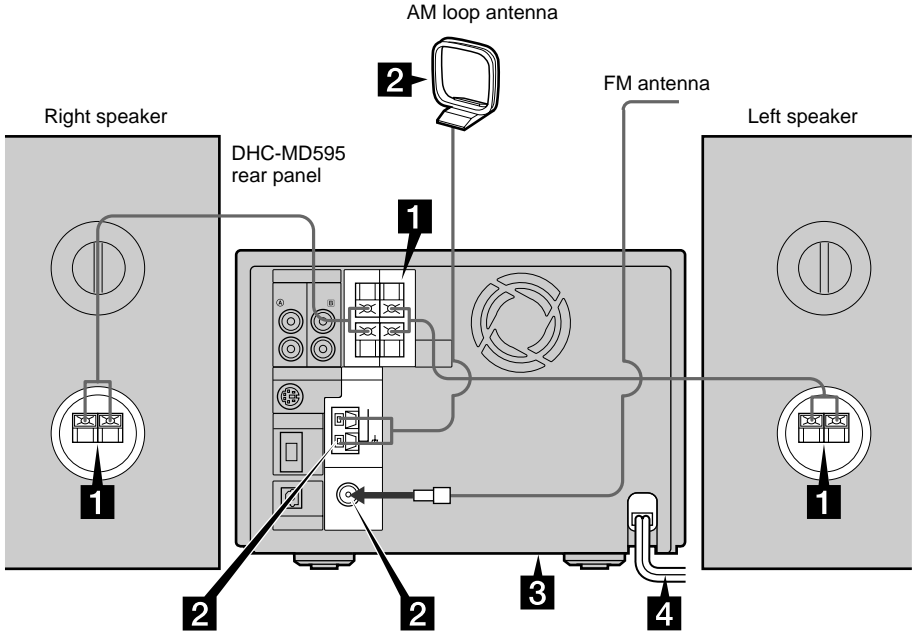

1 Connect the speakers.

Connect the speaker cords to the SPEAKER terminals on the unit and to the terminals on the speakers as below.

Keep the speaker cords away from the antennas to prevent noise.

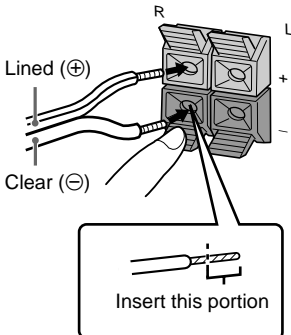

2 Connect the FM/AM antennas.

Set up the AM loop antenna, then connect it.

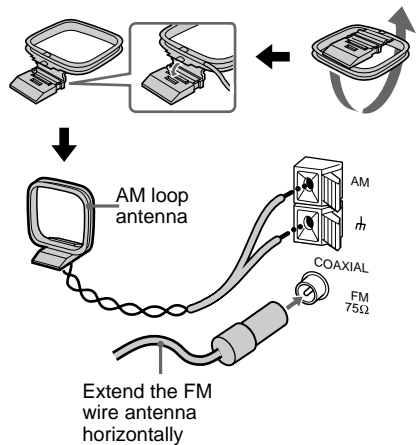

-
- 3** Set the VOLTAGE SELECTOR on the bottom of the system to the position of your local power line voltage (for models with a voltage selector).

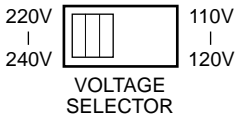

-
- 4** Connect the power cord to a wall outlet. If the plug of the power cord does not fit your wall outlet, attach the supplied adaptor on to the plug (for models with a plug adaptor).
-

Inserting two R6 (size AA) batteries into the remote

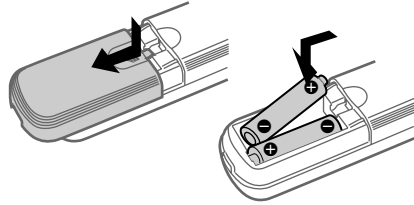

Tip

With normal use, the batteries should last for about six months. When the remote no longer operates the system, replace both batteries with new ones.

Notes

- If you do not use the remote for a long period of time, remove the batteries to avoid possible damage from battery leakage.
- Be sure to insert the batteries in correct direction.
- Do not mix new batteries with old ones.
- Do not use different types of batteries together.
- Do not use a battery that is leaking.
- If the battery leaks, clean the battery compartment and replace all the batteries with new ones.

Step 2: Setting the time

You must set the time beforehand to use the timer functions.

The clock is on a 24-hour system for the European model, and a 12-hour system for other models.

The 12-hour system is used for illustration purposes.

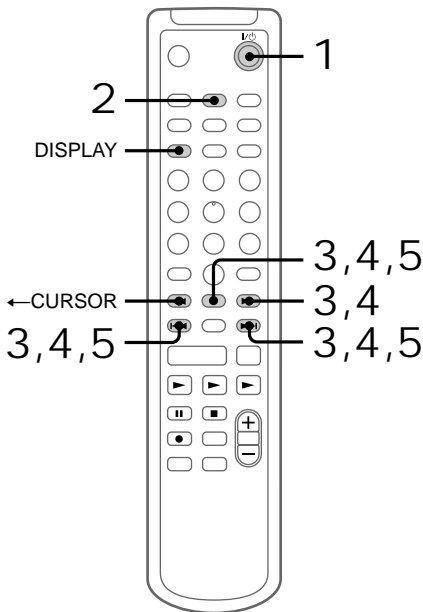

1 Turn on the system.

2 Press **CLOCK/TIMER SET**.

The time setting display appears, and the day indication "SUN" flashes.



3 Press **-** or **+** to set the day, then press **ENTER/YES** or **CURSOR→**.

The hour indication flashes.

(For models using a 12-hour system, noon is indicated as 0:00 PM, and midnight as 0:00 AM.)



4 Press **-** or **+** to set the hour, then press **ENTER/YES** or **CURSOR→**.

The minute indication flashes.

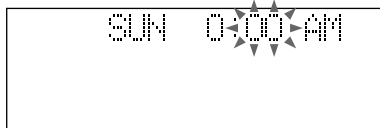

5 Press **-** or **+** to set the minute, then press **ENTER/YES**.

The clock starts.

If you made a mistake

Press **←CURSOR** or **CURSOR→** until the indication you wish to change (day, hour, minute) flashes, then change the setting.

Showing the time

In consideration of reducing standby power, this system can select whether or not to display the clock in standby mode. The system is set at the factory to not display the clock when the power is off (**Power Saving Mode**). To display the clock even when the power is off, press DISPLAY or TIME while the power is off. Press the button again to turn the clock display off and activate the Power Saving Mode.

While the system is on, the information that appears at the top of the display changes as follows each time you press DISPLAY.

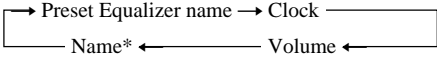

* Displayed only when disc title, track title, radio station name or other name information is labeled. No display when this information is not labeled.

Tip
The upper dot of the clock display flashes for the first half of a minute (0 to 29 seconds), and the lower dot flashes for the last half of a minute (30 to 59 seconds).

To change the preset time

You can change the preset time while the system is off.

- 1 Press CLOCK/TIMER SET.
- 2 Repeat steps 3 to 5 of "Setting the time".

Step 3: Presetting radio stations

You can preset the following number of stations, 20 for FM and 10 for AM.

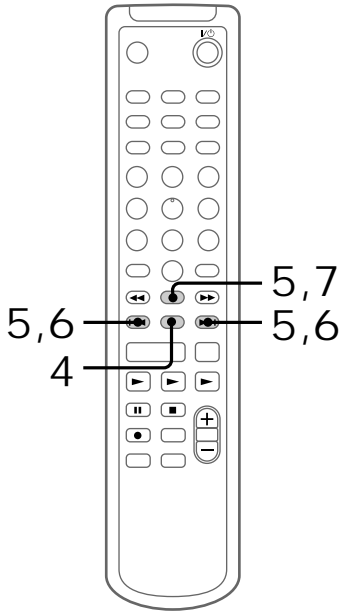
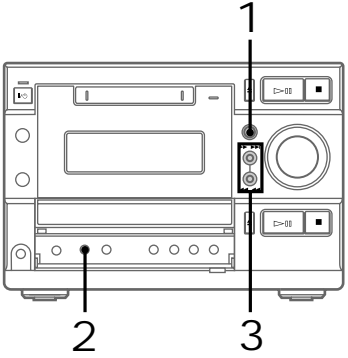

continued

Step 3: Presetting radio stations (continued)

- 1 Press TUNER/BAND to select “FM” or “AM”.
- 2 Press TUNING MODE repeatedly until “AUTO” appears.
- 3 Press TUNING + or –.
The frequency indication changes and the scanning stops when the system tunes in a station. “TUNED” and “STEREO” (for a stereo program) appear.
- 4 Press MENU/NO on the remote.
- 5 Press – or + on the remote repeatedly until “Memory?” appears, then press ENTER/YES on the remote.
The preset number starts flashing. Perform steps 6 and 7 while the preset number is flashing.
- 6 Press – or + on the remote repeatedly to select the desired preset number.
- 7 Press ENTER/YES.
“Complete!” appears, and then the station is stored.
- 8 Repeat steps 1 to 7 to preset other stations.

To stop scanning

Press TUNING MODE on the remote.

To tune in a station with a weak signal

Press TUNING MODE repeatedly until “MANUAL” appears in step 2, then press TUNING + or – repeatedly to tune in the station manually.

To change the preset number

Start over from step 1.

To change the AM tuning interval (except for the European model)

The AM tuning interval is factory-set to 9 kHz (10 kHz in some areas). To change the AM tuning interval, tune in any AM station first, then turn off the system. While holding down the FUNCTION, turn the system back on. When you change the interval, all the AM preset stations are erased. To reset the interval, repeat the same procedure.

Tips

- The preset stations are retained for about a day even if you disconnect the power cord or if a power failure occurs.
- You can label the preset stations (see page 53).
- When an FM program has static noise, press STEREO/MONO until “MONO” appears. There will be no stereo effect, but the reception will improve. Press the button again to restore the stereo effect.

Playing a CD

To turn on the system, press I/⏻ (power).

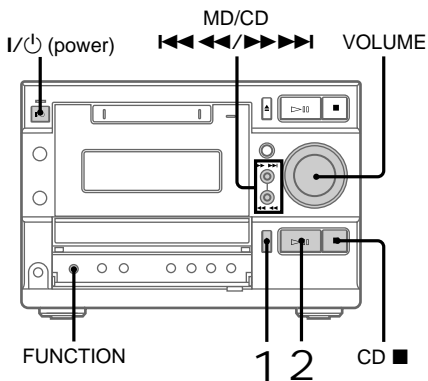

- 1 Press CD ▲ and place a CD on the disc tray.

With the label side up. When you play a single CD, place it on the inner circle of the tray.

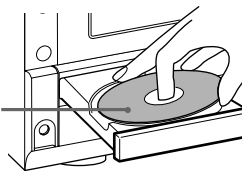

To close the disc tray, press CD ▲ again.

- 2 Press CD ▷◻◻.

The disc tray closes and play starts.

The ▷ indicator on the CD ▷◻◻ button lights green.

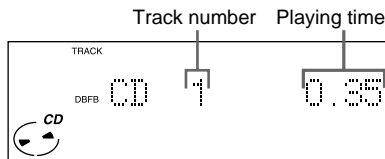

To	Do this
Stop play	Press CD ■.
Pause	Press CD ▷◻◻. The ◻◻ indicator on the CD ▷◻◻ button lights orange. Press again to resume play.
Select a track	Press MD/CD ◀◀◀◀ or ▶▶▶▶ repeatedly.
Find a point in a track	Keep pressing MD/CD ◀◀◀◀ or ▶▶▶▶ during play and release it at the desired point. “—OVER—” appears at the end of the CD.
Remove the CD	Press CD ▲.
Adjust the volume	Turn VOLUME.

Tips

- If there is no CD in the player, “No Disc” appears in the display.
- You can switch from another source to the CD player and start playing a CD just by pressing CD ▷◻◻ (**Automatic Source Selection**).
- You can start playing from the desired track in step 2.
 - 1 Press MD/CD ◀◀◀◀ or ▶▶▶▶ repeatedly until the desired track appears.
 - 2 Press CD ▷◻◻.
 Or, press the number buttons on the remote. The playback automatically starts. To enter track numbers 10 or over, press >10 and the track number. To enter 0, use the 10/0 button.

Notes

- Do not use a CD with tape, seals or paste on it as this may damage the CD player.
- Do not push the disc tray to close it, as this may damage the CD player. Press CD ▲ to close the disc tray.
- If you switch the function to TUNER, “CD” remains lit in the display even if you remove the CD. To turn off “CD”, press FUNCTION repeatedly until a function other than TUNER appears in the display.

Recording a CD on an MD — CD-MD Synchro Recording

You can make a digital recording of a CD on an MD, marking track numbers in the same sequence as the original CD.

In addition to normal-speed recording, you can also record at high speed (approximately four times the normal speed).

You can also select the recording method to suit your purpose (see page 24).

To turn on the system, press I/⏻ (power).

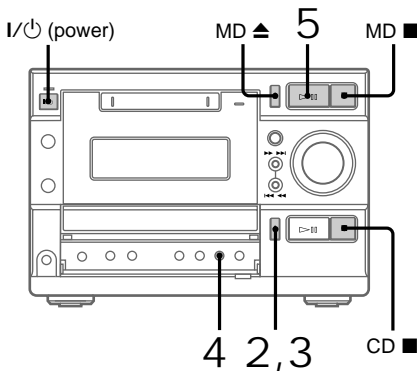

1 Insert a recordable MD.

With the arrow pointing toward the deck

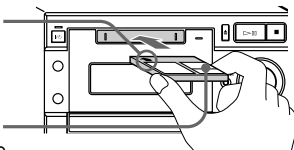

With the label side up, and the shutter on the righthand side

2 Press CD ▲ and place a CD on the disc tray.

With the label side up. When you play a single CD, place it on the inner circle of the tray.

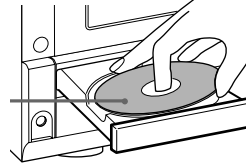

3 Press CD ▲ to close the disc tray.

4 Press CD-MD SYNC NORMAL.

To record at high speed, press CD-MD SYNC HIGH.

“NORMAL SPEED” (“HIGH SPEED” for high-speed recording) appears. The MD deck stands by for recording and the CD player pauses for play.



5 Press MD ▷▢.

Recording starts. **You cannot monitor the recorded signal during high-speed recording.** When the recording is completed, the CD player and the MD deck stop automatically.

To stop recording

Press MD ■.

If the MD becomes full during recording, the MD deck and the CD player automatically stop.

Tips

- If you use a partially recorded MD, recording starts after the recorded tracks.
- Depending on the disc, CD TEXT information may also be recorded. If “TEXT” flashes during recording, press NAME EDIT/SELECT on the remote, and then press ENTER/YES on the remote to record the title of the current track. (If “TEXT” is lit, it is automatically recorded.)
- You can switch the recording mode before step 4 and record for long times. For details, see “Recording for long times” on page 28.

Notes

- If the play mode is set to Repeat Play or Shuffle Play, it automatically switches to normal play at step 4.
- If the MD is record protected, “C11” and “Protected” appear alternately and the MD cannot be recorded. Remove the MD, then slide the record protection tab to the closed position (see page 24).
- If “Retry” flashes in the display, a reading failure has occurred, and the system is trying to read the data again (see page 27).

Playing an MD

To turn on the system, press I/⏻ (power). You can play an MD just like a CD.

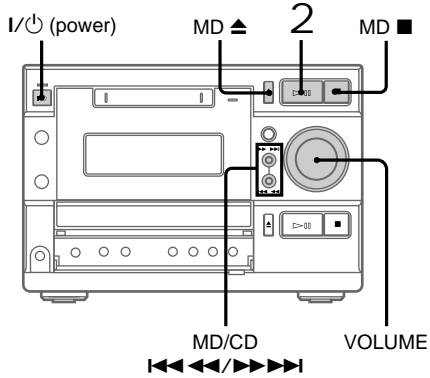

1 Insert an MD.

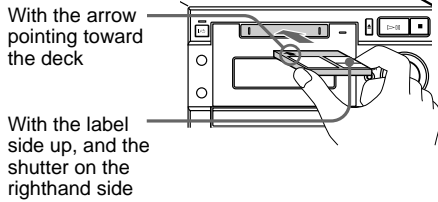

2 Press MD ▷||.

Play starts. The ▷ indicator on the MD ▷|| button lights green.

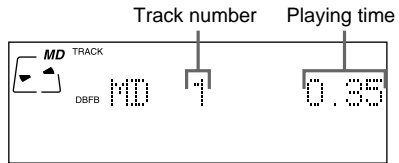

continued

Playing an MD (continued)

To	Do this
Stop play	Press MD ■.
Pause	Press MD ▷◁. The ◁◁ indicator on the MD ▷◁ button lights up orange. Press again to resume play.
Select a track	Press MD/CD ◀◀◀◀ or ▶▶▶▶ repeatedly.
Find a point in a track	Keep pressing MD/CD ◀◀◀◀ or ▶▶▶▶ during play and release it at the desired point.
Remove the MD	Press MD ▲.
Adjust the volume	Turn VOLUME.

Tips

- You can start playing from the desired track in step 2.
 - Press MD/CD ◀◀◀◀ or ▶▶▶▶ repeatedly until the desired track appears.
 - Press MD ▷◁.
 Or, press the number buttons on the remote. The playback automatically starts. To enter track numbers 10 or over, press >10 (press twice to enter 100 or over), then press the track number. To enter 0, use the 10/0 button.
- You can switch from another source to the MD deck and start playing an MD just by pressing MD ▷◁ (Automatic Source Selection).

Note

Do not use an MD on which the label sticks out from the edge or on which the label is not positioned correctly. Such labels can cause the MD deck to malfunction.

Listening to the radio

— Preset Tuning

Preset radio stations in the tuner's memory first (see page 7).

To turn on the system, press I/⏻ (power).

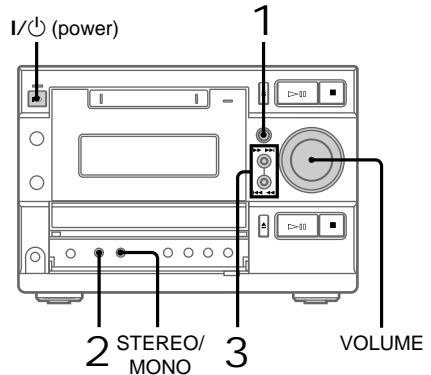

1 Press TUNER/BAND to select “FM” or “AM”.

2 Press TUNING MODE repeatedly until “PRESET” appears.

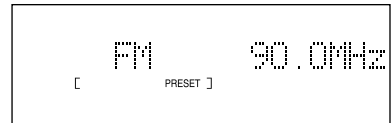

3 Press TUNING + or – to select the desired preset station.

Station name* or RDS station name**

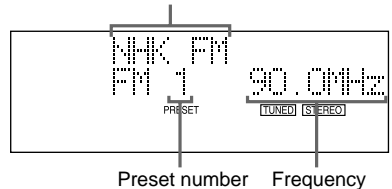

* The station name appears only if you have labeled the station (see page 53).

** European model only.

To	Do this
Turn off the radio	Press I/⏻ to turn off the system.
Adjust the volume	Turn VOLUME.

To select the preset number using the remote

Press the number buttons on the remote in step 3. To enter preset numbers 10 or over, press >10 and the preset number. To enter 0, use the 10/0 button.

Listening to non-preset radio stations

- Press TUNING MODE repeatedly until “MANUAL” appears in step 2, then press TUNING + or – to tune in the desired station (**Manual Tuning**).
- Press TUNING MODE repeatedly until “AUTO” appears in step 2, then press TUNING + or –. The frequency indication changes and the scanning stops when the system tunes in a station (**Automatic Tuning**).

To cancel Automatic Tuning

Press TUNING MODE.

Tips

- You can switch from another source to the tuner just by pressing TUNER/BAND (**Automatic Source Selection**).
- To improve broadcast reception, adjust the supplied antennas, or connect a commercially available external antenna (see page 60).
- When an FM stereo program has static noise, press STEREO/MONO until “MONO” appears. There will be no stereo effect, but the reception will improve. Press the button again to restore the stereo effect.

Recording from the radio — Manual Recording

You can analog record a radio program on an MD. If you use a partially recorded MD, recording starts after the recorded tracks. To erase the recorded contents, see “Erasing recordings” on page 40. To turn on the system, press I/⏻ (power).

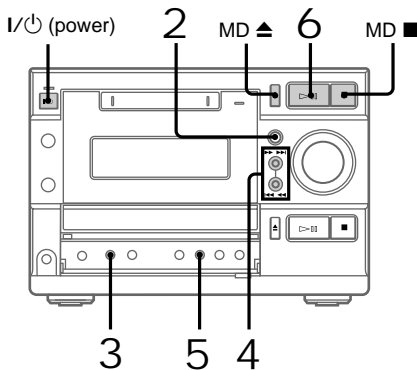

1 Insert a recordable MD.

With the arrow pointing toward the deck

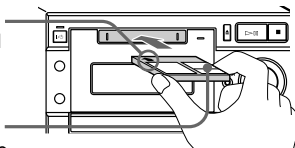

With the label side up, and the shutter on the righthand side

2 Press TUNER/BAND to select “FM” or “AM”.

3 Press TUNING MODE repeatedly until “PRESET” appears.

continued

Recording from the radio (continued)

-
- 4 Press TUNING + or – to select the desired preset station.

Station name* or RDS station name**

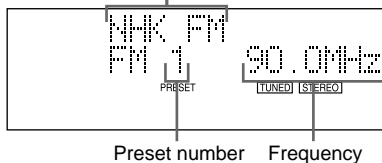

* The station name appears only if you have labeled the station (see page 53).

** European model only.

You can select the preset numbers with the numeric buttons on the remote.

-
- 5 Press REC/REC IT.
The MD deck stands by for recording.

-
- 6 Press MD ▷▶.
Recording starts.
-

To stop recording

Press MD ■.

Tips

- If noise is heard while recording an AM radio program, move the AM loop antenna to reduce the noise or connect a ground wire to the \hbar terminal (see page 60).
- You can switch the recording mode before step 5 and record for long times. For details, see “Recording for long times” (page 28).
- You can adjust the recording level to the desired volume after performing step 5 (see page 36).

Note

If the MD is record protected, “C11” and “Protected” appear alternately and the MD cannot be recorded. Remove the MD, then slide the record protection tab to the closed position (see page 24).

Playing CD tracks repeatedly — Repeat Play

You can repeat a CD in normal play, Shuffle Play and Program Play.

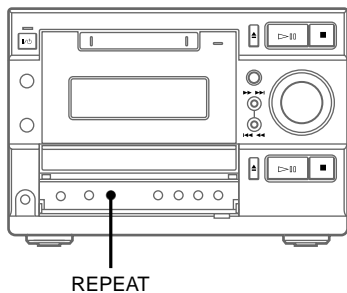

- ➔ Press REPEAT during play until “REPEAT” or “REPEAT 1” appears.

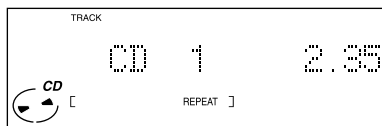

REPEAT*: For all the tracks on the CD.

REPEAT 1: For a single track only.

* The CD player repeats the tracks up to five times.

To cancel Repeat Play

Press REPEAT until “REPEAT” or “REPEAT 1” disappears.

Playing CD tracks in random order — Shuffle Play

You can play all the tracks on a CD in random order.

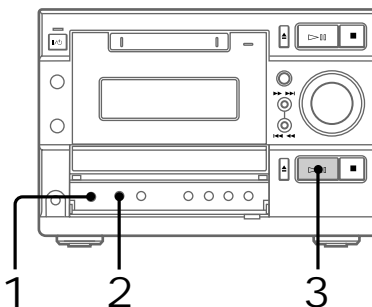

- 1 Press FUNCTION repeatedly to switch the function to CD.
- 2 Press PLAY MODE repeatedly until “SHUFFLE” appears in stop mode.

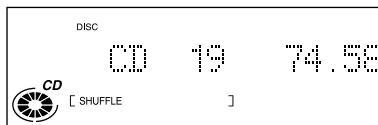

- 3 Press CD ▷◻◻. Shuffle Play starts.

To cancel Shuffle Play

Press CD ◼ to stop Shuffle Play, then press PLAY MODE repeatedly until “SHUFFLE” and “PROGRAM” disappear.

Tip

To skip a track, press MD/CD ►►►►.

Programming CD tracks

— Program Play

You can make a program of up to 25 steps in the order you want them to be played. You can also make a Synchro Recording of the program on the MD (see page 25).

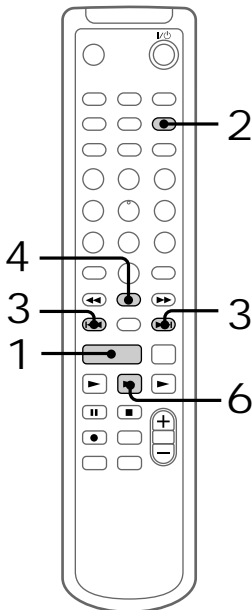

1 Press **FUNCTION** repeatedly to switch the function to CD.

2 Press **PLAY MODE** repeatedly until “PROGRAM” appears in stop mode.

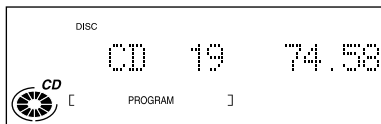

3 Press **◀◀** or **▶▶** repeatedly until the desired track appears in the display.

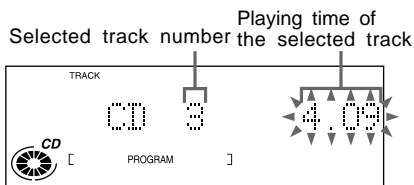

4 Press **ENTER/YES**.

The track is programmed.

“Step” appears, followed by the number of the track in the programmed sequence. The number of the last programmed track appears, followed by the total playing time of the program. If you have made a mistake, you can clear the last programmed track from the program by pressing **CLEAR**.

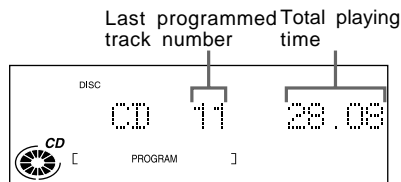

5 To program additional tracks, repeat steps 3 and 4.

6 Press **CD ▶**.

All the tracks play in the order you selected.

To check the total number of programmed tracks

Press **TIME** in stop mode. The total number of programmed steps appears, followed by the last programmed track number and the total playing time of the program.

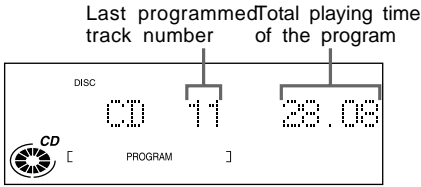

To check the program order

Press **◀** or **▶** repeatedly during Program Play.

To	Do this
Cancel Program Play	Press ■ , then press PLAY MODE repeatedly until "PROGRAM" and "SHUFFLE" disappear.
Add a track to the program (in stop mode)	Do steps 3 and 4.
Erase the last programmed track	Press CLEAR in stop mode. Each time you press the button, the last programmed track is erased.

To select the desired track using the number buttons

Press number buttons instead of performing steps 3 to 5.

To enter track numbers 10 or over, press **>10** and the track number. To enter 0, use the **10/0** button.

Tips

- The program you made remains after Program Play finishes. To play the same program again, press **▶**.
- "Step Full!" appears when you try to program 26 or more tracks (steps).
- "--:--" appears when the total CD program time exceeds 100 minutes, or when you select a CD track whose number is 21 or over.

Using the display

You can check the time remaining in a single track, or on an entire CD. You can also check the disc title or a track title of a CD. Use the **DISPLAY** button (top) and the **TIME** button (bottom) to switch the display.

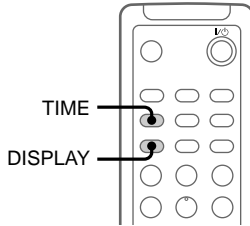

Use the **DISPLAY** button to switch the display.

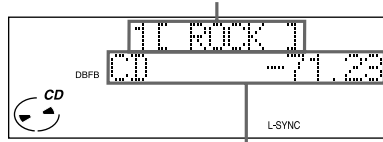

Use the **TIME** button to switch the display.

Checking the remaining time

➔ Press **TIME** during play.

Each time you press the button, the display changes as follows:

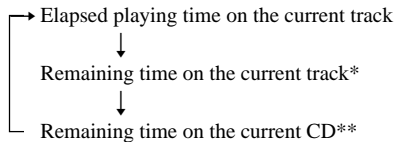

* "--:--" appears when you check the remaining time of a CD track whose number is 21 or over.

** "--:--" appears during Shuffle Play of a CD which has 21 or more tracks, or during Program Play when a CD track whose number is 21 or over is selected.

continued

Checking a track title or a disc title

➔ Press DISPLAY during play or in stop mode.

Each time you press the button, the display changes as follows:

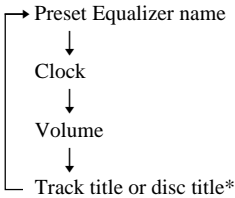

* The track title appears during play (only for a CD with CD text), and the disc title appears while stopped. If a CD that has no title is loaded, nothing appears.

To scroll a long name

Press SCROLL on the remote.
The title appears scrolling in the display.

Tips

- If you press TIME for a CD with CD text containing the artist name, the artist name appears scrolling in the display.
- To label a disc title to a CD, see “Labeling a CD” on this page.

Labeling a CD — Disc Memo

You can label up to 100 CDs with titles of up to 20 symbols and characters. Whenever you load a labeled CD, the title appears in the display.

Note

When labeling CDs for the first time, be sure to perform the operations in “Erasing all disc titles stored in the system memory” on page 20 beforehand.

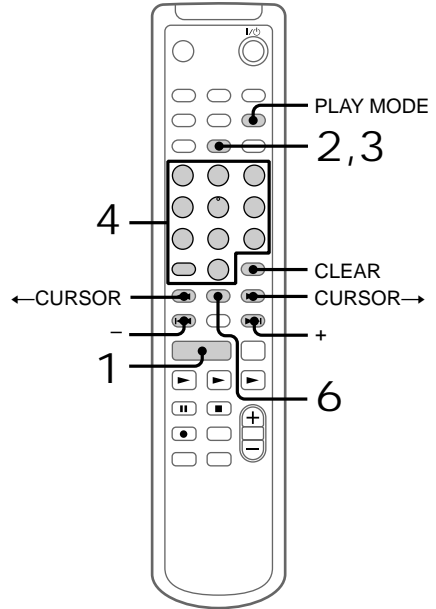

1 Press FUNCTION repeatedly to switch the function to CD.

Make sure the total number of tracks and the total playing time appear in the display in stop mode. If “SHUFFLE” or “PROGRAM” appears in the display, press PLAY MODE repeatedly until both disappear.

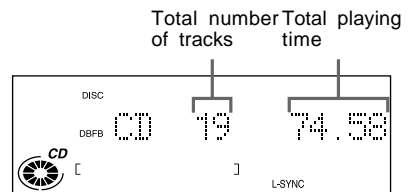

- 2 Press NAME EDIT/SELECT.
The text input screen appears, and the cursor flashes.

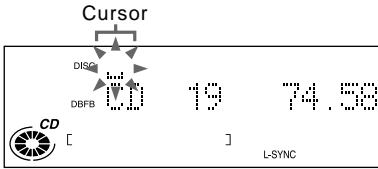

- 3 Press NAME EDIT/SELECT to select the desired type of character.

Each time you press the button, the display changes as follows:

Selected AB* (Upper cases) → Selected ab
(Lower cases) → Selected 12 (Numbers) →
Selected AB (Upper cases) → ...

* Press number 1 repeatedly to display the following symbols.

' - / , . () : ! ?

In addition, when the symbols above appear in the display, press - or + repeatedly to display the following symbols.

& + < > _ = " ; # \$ % @ * `

- 4 Enter a character.

If you've selected uppercase or lowercase letters

1 Press the corresponding letter/number button repeatedly until the character to be entered flashes.

Or, press the button once and press - or + repeatedly.

2 Press CURSOR→.

The flashing character is entered and the cursor shifts to the right.

If you've selected numbers

Press the corresponding number button.

The number is entered and the cursor shifts to the right.

- 5 Repeat steps 3 and 4 to enter the rest of the name.

To change a character

Press ←CURSOR or CURSOR→ repeatedly until the character to be changed flashes, press CLEAR to erase the character, then repeat steps 3 and 4.

- 6 Press ENTER/YES to complete the labeling procedure.

The disc title is stored in the system memory and then the original display appears.

To cancel labeling

Press MENU/NO.

Checking the disc titles

- 1 Press MENU/NO in stop mode.
- 2 Press - or + repeatedly until "Name Check?" appears, then press ENTER/YES.
- 3 Press - or + repeatedly to select the disc titles stored in the system memory between 001 and 100.

To check the current disc title

Press SCROLL in stop mode.

continued

Labeling a CD (continued)

Erasing a disc title

- 1 Press MENU/NO in stop mode.
- 2 Press – or + repeatedly until “Name Erase?” appears, then press ENTER/YES.
The disc title appears scrolling in the display.
“No Name” appears if no disc title is labeled.
- 3 Press ENTER/YES again.
“Complete!” appears and the disc title is erased.

To cancel erasing

Press MENU/NO during steps 1 and 2.

Erasing all disc titles stored in the system memory

- 1 Press MENU/NO in stop mode.
- 2 Press – or + repeatedly until “All Erase?” appears, then press ENTER/YES.
“All Erase??” appears.
- 3 Press ENTER/YES again to erase disc titles.
“Complete!” appears and all disc titles are erased.

To cancel erasing

Press MENU/NO during steps 1 and 2.

Note

Turn on the system power about once a week to ensure the stored disc titles are not erased.

Playing MD tracks repeatedly — Repeat Play

You can repeat an MD in normal play, Shuffle Play and Program Play.

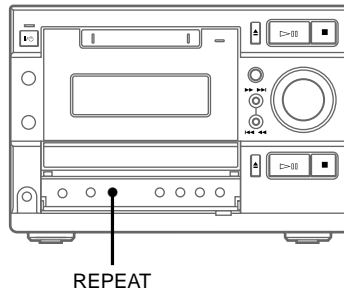

- ➔ Press REPEAT during play until “REPEAT” or “REPEAT 1” appears.

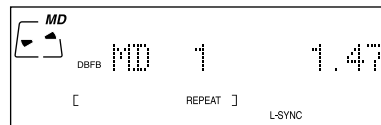

REPEAT*: For all the tracks on the MD.
REPEAT 1: For a single track only.

* The MD deck repeats the tracks up to five times.

To cancel Repeat Play

Press REPEAT until “REPEAT” or “REPEAT 1” disappears.

Playing MD tracks in random order — Shuffle Play

You can play all the tracks on an MD in random order.

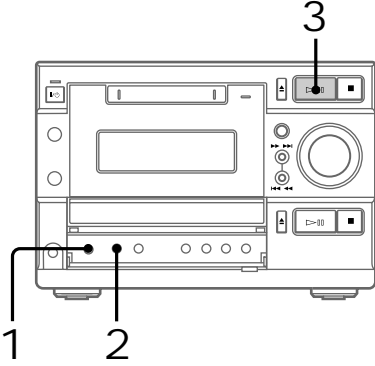

- 1 Press FUNCTION repeatedly to switch the function to MD.
- 2 Press PLAY MODE repeatedly until "SHUFFLE" appears in stop mode.

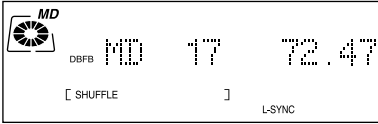

- 3 Press MD \blacktriangleright \square . Shuffle Play starts.

To cancel Shuffle Play

Press MD \blacksquare to stop Shuffle Play, then press PLAY MODE repeatedly until "SHUFFLE" and "PROGRAM" disappear.

Tip
To skip a track, press MD/CD $\blacktriangleright\blacktriangleright\blacktriangleright\blacktriangleright$.

Programming MD tracks — Program Play

You can make a program of up to 25 steps in the order you want them to be played.

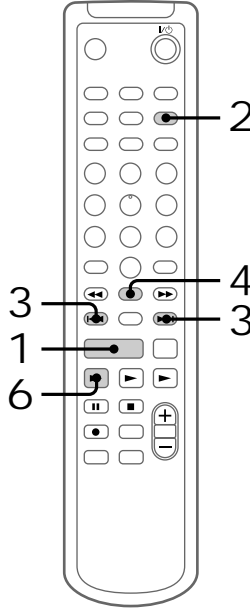

- 1 Press FUNCTION repeatedly to switch the function to MD.
- 2 Press PLAY MODE repeatedly until "PROGRAM" appears in stop mode.
- 3 Press $\blacktriangleleft\blacktriangleleft$ or $\blacktriangleright\blacktriangleright$ repeatedly until the desired track appears in the display.

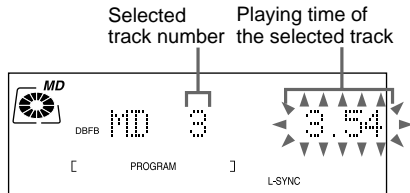

continued

Programming MD tracks (continued)

4 Press ENTER/YES.

The track is programmed.
“Step” appears, followed by the number of the track in the programmed sequence. The number of the last programmed track appears, followed by the total playing time of the program. If you have made a mistake, you can clear the last programmed track from the program by pressing CLEAR.

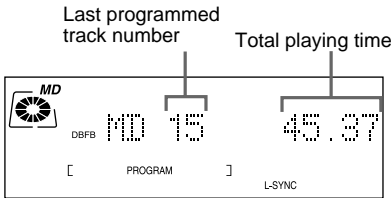

5 To program additional tracks, repeat steps 3 and 4.

6 Press MD ►.

All the tracks play in the order you selected.

To check the total number of programmed tracks

Press TIME in stop mode. The total number of programmed steps appears, followed by the last programmed track number and the total playing time of the program.

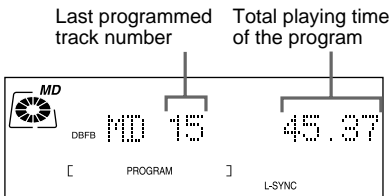

To check the program order

Press ◀◀ or ▶▶ repeatedly during Program Play.

To	Do this
Cancel Program Play	Press ■, then press PLAY MODE repeatedly until “PROGRAM” and “SHUFFLE” disappear.
Add a track to the program (in stop mode)	Do steps 3 and 4.
Erase the last programmed track	Press CLEAR in stop mode. Each time you press the button, the last programmed track is erased.

To select the desired track using the number buttons

Press number buttons instead of performing steps 3 to 5.

To enter track numbers 10 or over, press >10 (press twice to enter 100 or over) and the track number. To enter 0, use the 10/0 button.

Tips

- The program you made remains after Program Play finishes. To play the same program again, press MD ►.
- “Step Full!” appears when you try to program 26 or more tracks (steps).
- “---:--” appears when the total MD program time exceeds 1,000 minutes.

Using the display

You can check the time remaining in a single track, or on an entire MD. You can also check the disc title or a track title of an MD. Use the DISPLAY button (top) and the TIME button (bottom) to switch the display.

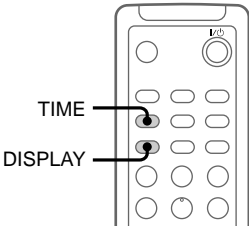

Use the DISPLAY button to switch the display.

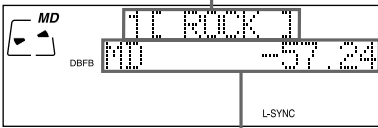

Use the TIME button to switch the display.

Checking the remaining time

➔ Press TIME during play. Each time you press the button, the display changes as follows:

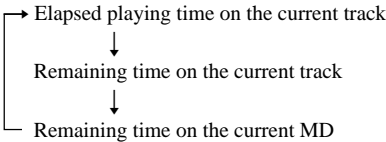

Checking the total playing time

➔ Press TIME in stop mode. Each time you press the button, the display changes as follows:

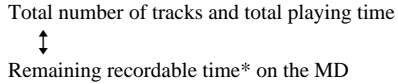

* The remaining recordable time on the MD changes according to the recording mode.

Checking a track title or a disc title

➔ Press DISPLAY during play or in stop mode. Each time you press the button, the display changes as follows:

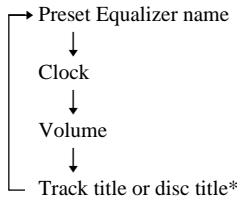

* The track title appears during play, and the disc title appears while stopped. If an MD that has no title is loaded, nothing appears.

To scroll a long name
Press SCROLL on the remote.
The title appears scrolling in the display.

Tip
To label a disc title or track titles to an MD, see "Labeling an MD" on page 38.

Before you start recording

MDs (Mini Disc) let you digitally record and play music with high quality sound. Another feature of MDs is track marking. The track marking feature lets you quickly locate a specific point or easily edit the recorded tracks. However, depending on the source you record, the recording method and the way the track numbers are recorded differ.

When the source you record from is:

- This system's CD player
 - The MD deck performs digital recording.*¹
 - Track numbers are automatically marked as on the original CD. However, track numbers may not be marked for some tracks (see page 63).
- Other digital components connected to the DIGITAL OPTICAL IN jack (e.g., CS/BS tuner)
 - The MD deck performs digital recording.*¹
 - Track numbers are marked differently depending on the source you record.
- This system's tuner and other analog components connected to the TAPE IN jacks or ANALOG IN jack (e.g., the optional tape deck TC-TX595)
 - The MD deck performs analog recording.
 - A track number is marked at the beginning of a recording, but when you turn on the Level Synchro Recording function (see page 32), track numbers are automatically marked in sync with the level of the input signal.

*¹ For details on the limitations of digital recording, see page 63.

Note on MD track numbers

On an MD, the track numbers (track sequence), track start and end point information, etc., are recorded in the TOC*² area independent of the sound information. You can edit recorded tracks quickly by modifying the TOC information.

*² TOC: Table Of Contents

After recording

- ➔ Press MD ▲ to remove the MD or press I/⏻ (power) to turn off the system. "TOC" lights up or starts flashing. The TOC is updated and recording is completed.

Before pulling out the power cord

MD recording is completed when the MD Table of Contents (TOC) is updated. The TOC is updated when you eject the MD or press I/⏻ to turn off the system. Do not pull out the power cord before updating the TOC (while "TOC" is lit) or while updating the TOC (while "TOC" is flashing) to ensure a complete recording.

Protecting a recorded MD

- To protect a recorded MD, slide the tab on the side of the MD to open the slot. In this position, the MD cannot be recorded. To record on the MD, slide the tab to close the slot.

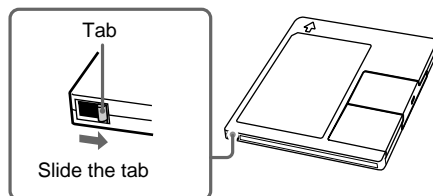

- If the MD is record protected, "C11" and "Protected" appear alternately and the MD cannot be recorded. Remove the MD, then slide the record protection tab to the closed position.

Recording your favorite CD tracks on an MD

— CD-MD Synchro Recording

You can select your favourite CD tracks with the Program Play feature, then record the program on an MD using the CD-MD Synchro Recording feature. If you use a partially recorded MD, recording starts after the recorded tracks.

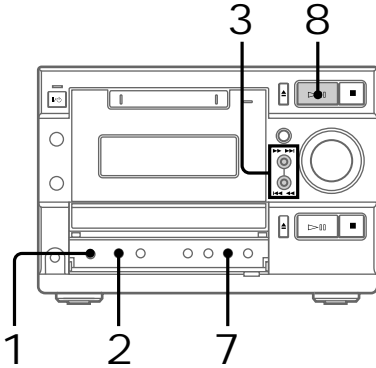

Selecting the tracks

- 1 Press **FUNCTION** repeatedly to switch the function to CD.
- 2 Press **PLAY MODE** repeatedly until "PROGRAM" appears in stop mode.
- 3 Press **MD/CD** **◀◀◀◀** **▶▶▶▶** repeatedly until the desired track number appears.

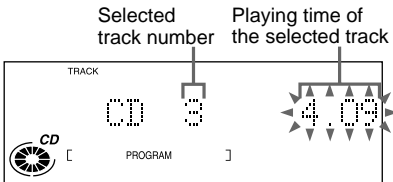

- 4 Press **ENTER/YES** on the remote.
The track is programmed. "Step" appears, followed by the number of the track in the programmed sequence. The number of the last programmed track appears, followed by the total playing time of the program.

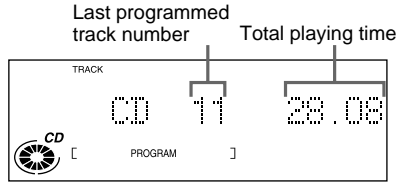

- 5 To program additional tracks, repeat steps 3 and 4.

Recording on an MD

- 6 Insert a recordable MD.
- 7 Press **CD-MD SYNC NORMAL**.
The MD deck stands by for recording and the CD player pauses for play.
- 8 Press **MD** **▶▶**
CD playing and MD recording start. The CD player and the MD deck stop automatically when the recording is completed.

To stop recording

Press **MD** **■**

If the MD becomes full during recording, the MD deck and the CD player automatically stop.

continued

Recording your favorite CD tracks on an MD (continued)

Notes

- If the play mode is set to Repeat Play or Shuffle Play, it automatically switches to normal play at step 7.
- If the MD is record protected, “C11” and “Protected” appear alternately and the MD cannot be recorded. Remove the MD, then slide the record protection tab to the closed position (see page 24).
- The following items are either inoperative or cannot be used during CD-MD Synchro Recording:
 - The Auto Cut function
 - The recording level specified in the Setup menu

Labeling titles during recording

If “TEXT” lights up or flashes during recording, you can record the CD TEXT information on to the MD as follows:

- Automatically during recording
When “TEXT” is lit, all track titles are automatically recorded.
- Manually during recording
When “TEXT” flashes, press NAME EDIT/SELECT on the remote, and then press ENTER/YES on the remote to record the title of the current track.

Note

Depending on the disc, the CD TEXT information may not be recorded automatically.

Recording a CD on an MD at high speed

— High-Speed CD-MD Synchro Recording

This function allows you to record from a CD to an MD at approximately four times the normal speed during CD-MD Synchro Recording and Program Recording.

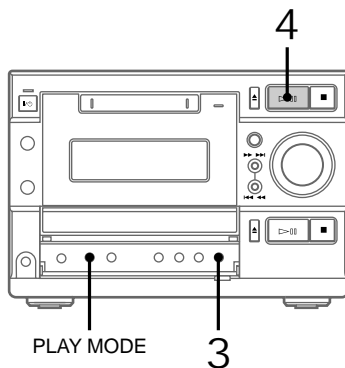

- 1 Insert a recordable MD.
- 2 Load a CD.
To record tracks in the order you programmed, press PLAY MODE repeatedly until “PROGRAM” appears. (If you have not made a program, see page 16.)
- 3 Press CD-MD SYNC HIGH.
“HIGH SPEED” appears and “HIGH” lights up in the display.
The MD deck stands by for recording and the CD player pauses for play.

4 Press MD ▷

High-speed recording starts. **You cannot monitor the recorded signal during recording.** When the recording is completed, the CD player and the MD deck stop automatically.

To stop recording

Press MD ■

If “Retry” flashes in the display after you press MD ▷ in step 4 A reading failure has occurred, and the system is trying to read the data again.

- If the retry was successful, the system continues with High-Speed CD-MD Synchro Recording.
- If the condition of the inserted CD or the system is poor, and retry fails, High-Speed CD-MD Synchro Recording is disabled. In this case, “NORM” flashes and the deck automatically starts recording in normal CD-MD Synchro Recording. Note that monitoring of the recorded signal is not possible when this occurs.

Notes

- You cannot record over existing material during High-Speed CD-MD Synchro Recording. The system automatically starts recording from the end of the existing material.
- Make sure that the remaining recordable time on the MD is longer than the playing time of the CD, especially if you want to record all the tracks on the CD.
- You cannot pause recording during High-Speed CD-MD Synchro Recording.
- If the play mode is set to Repeat Play or Shuffle Play, it automatically switches to normal play at step 3.
- When recording in LP2 or LP4 Stereo mode, recording takes approximately twice as long as normal high-speed recording.
- The following items are either inoperative or cannot be used during High-Speed CD-MD Synchro Recording:
 - The Auto Cut function
 - The recording level specified in the Setup menu
- With the following kinds of CDs, you may experience a reading failure or noise when recorded to an MD:
 - CDs with adhesive labels attached to them
 - Irregularly shaped CDs (for example, heart- or star-shaped)
 - CDs with printed text concentrated on one side only
 - Old CDs
 - Scratched CDs
 - Dirty CDs
 - Warped CDs
- If the following occurs during CD playback or recording, a reading error may occur or noise may be produced in the recorded results:
 - The CD tray or other part of the system is bumped.
 - The system is placed on an uneven or soft surface.
 - The system is located near a speaker, door, or other source of vibration.
- If the above reading errors occur, an extra track may be created.
- If you don't perform step 4 within about 1 minute after pressing CD-MD SYNC HIGH in step 3, the system returns to the original condition.
- The sound does not come from the TAPE OUT jacks during High-Speed CD-MD Synchro Recording.

Recording the current track — Rec It

You can record a track quickly while listening to a CD.

If the MD has been partially recorded, recording starts after the recorded tracks.

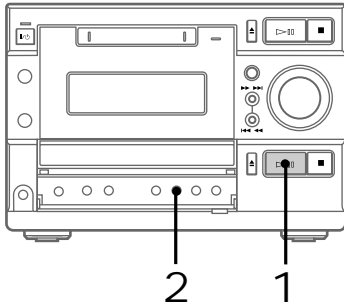

- 1 Press CD ▷▶ play starts.
- 2 Press REC/REC IT while listening to a track you want to record.
Play returns to the start of the track and recording starts. The MD deck stops automatically at the end of the track.

To stop recording

Press MD ■

Note

The following items are either inoperative or cannot be used during Rec It:

- The Auto Cut function
- The recording level specified in the Setup menu

Recording for long times

This system has two long time recording modes: LP2 and LP4 (MDLP recording). When recording in LP2 Stereo mode, you can record 2 times the normal recordable time, and in LP4 Stereo mode, you can record 4 times the normal recordable time. In addition, the recordable time for monaural recording is approximately double the stereo recording time.

Note

Tracks recorded in MDLP (LP2 or LP4) Stereo mode cannot be played back on a system that does not support MDLP mode. In addition, you cannot use S.F Edit and some other MD edit functions for tracks recorded in MDLP mode.

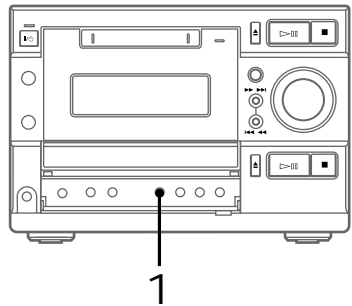

- 1 Press REC MODE repeatedly to select the recording mode before starting to record with CD-MD Synchro Recording, etc.
STEREO REC (Stereo) → LP2 REC (LP2 Stereo) → LP4 REC (LP4 Stereo) → MONO REC (Monaural) → STEREO REC (Stereo) → ...

- 2 Start the recording.

The source is recorded in the selected recording mode.

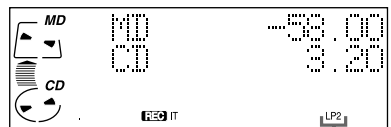

Selected recording mode
(No indicator in stereo mode)

To change the recording mode

The selected recording mode is kept even after recording has finished, so be sure to check the recording mode before recording. To change the recording mode, press REC MODE repeatedly to switch to the recording mode you want.

During High-Speed CD-MD Synchro Recording

The recording speed changes according to the recording mode.

Recording mode	Recording speed
Stereo	Quadruple speed
LP2 Stereo	Double speed
LP4 Stereo	Double speed
Monaural	Quadruple speed

Notes

- MDs recorded in MDLP (LP2 or LP4) mode should be played back on a system that supports MDLP mode. These MDs cannot be played back on other systems.
- Even if you press REC MODE during recording or recording pause, you cannot change the recording mode.
- Even if you press REC MODE repeatedly to select MONO, the monitor signal during recording does not become monaural.

To add "LP:" at the beginning of a track name during MDLP recording

"LP:" appears when you try to play the track on a system that does not support MDLP mode. This convenient function lets you know at a glance that the track cannot be played back. The factory setting is "On".

- 1 Press FUNCTION repeatedly to switch the function to MD.
- 2 Press MENU/NO on the remote repeatedly until "Setup Menu" appears.
- 3 Press - or + on the remote until "LP Stamp Off" (or "LP Stamp On") appears, then press ENTER/YES.
- 4 Press - or + on the remote until "LP Stamp On" appears, then press ENTER/YES.
- 5 Press MENU/NO.

Notes

- The recorded "LP:" is a stamp which appears to indicate that the track cannot be played back when you try to play the track on system that does not support MDLP mode. It does not appear for systems that support MDLP mode.
- When set to "On", "LP:" is recorded as the track name, so the number of characters that can be input to an MD is reduced. In addition, when you copy a track name with "LP:" added, "LP:" is automatically added to the copied track name. If you divide an "LP:" track using the Divide function, "LP:" is also added to the latter track.

Recording on an MD manually — Manual Recording

If you use a partially recorded MD, recording starts after the recorded tracks.

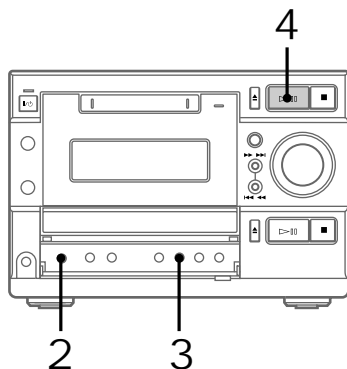

- 1 Insert a recordable MD.
- 2 Press FUNCTION repeatedly to select the desired source to record.
 - CD: Recording from the CD
 - TUNER: Recording from the radio
- 3 Press REC/REC IT.
The MD deck stands by for recording.
- 4 Press MD ▷|||
Recording starts.

- 5 Start playing the desired source (CD, etc.) to record.

When recording from this system's CD player, the track numbers are automatically marked. Press REC/REC IT during recording to mark the track numbers at the desired point. If you want to mark track numbers automatically during recording from the radio, see "Marking track numbers" on page 32.

To stop recording

Press MD ■

Tips

- You can adjust the recording level to the desired volume after performing step 3 (see page 36).
- You can check the remaining recordable time on the MD during recording by pressing TIME on the remote.

Note

If you pause recording during CD recording, a track number is recorded at that point. Also, note that the tracks might be recorded as the same single track with a single track number when the same single track of the same CD is recorded repeatedly.

Starting recording with 6 seconds of prestored audio data

— Time Machine Recording

When recording from an FM or satellite broadcast, the first few seconds of material are often lost due to the time it takes you to ascertain the contents and press the record button. To prevent the loss of this material, the Time Machine Recording feature constantly stores the most recent audio data in a buffer memory. This lets you record the sound from 6 seconds before starting recording, as shown in the illustration below:

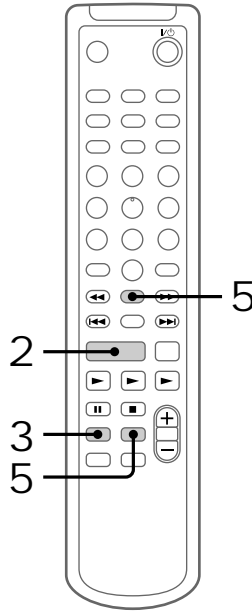
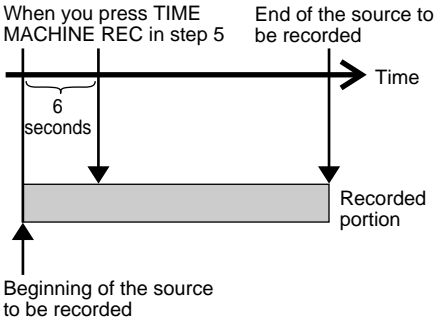

- 1 Insert a recordable MD.
- 2 Press FUNCTION repeatedly until the desired source to record appears.
- 3 Press MD ● REC.
The MD deck stands by for recording.

continued

Starting recording with 6 seconds of prestored audio data (continued)

- 4 Start playing the desired source to record.
- 5 Press TIME MACHINE REC at the desired point to start recording.
Recording of the source starts with the 6 seconds of audio data stored in the buffer memory.
If you use a partially recorded MD, recording starts after the recorded tracks.

To stop Time Machine Recording

Press ■

Note

The MD deck starts storing audio data when the deck stands by for recording in step 3 and you start playing the source. If less than 6 seconds have passed when you press TIME MACHINE REC, Time Machine Recording starts with less than 6 seconds of audio data.

Marking track numbers

You can mark track numbers:

• Automatically during recording

Track numbers are automatically marked as on the original source during recording from this system's CD player or components connected to the DIGITAL OPTICAL IN jack. However, track numbers may not be marked for some tracks (see page 63). Use the Level Synchro Recording function to automatically mark track numbers during recording from this system's tuner or components connected to the ANALOG IN jack or the TAPE IN jacks. However, you may not mark track numbers automatically if the sound source to be recorded is noisy (e.g., tapes or radio programs).

• At any point during recording

You can mark track numbers during recording any sources.

• After recording

Use the Divide Function (see page 45).

Marking track numbers automatically during recording — Level-Synchro Recording

The Level Synchro Recording function is factory set to on, so the track numbers are automatically marked. If "L-SYNC" does not appear during recording, turn on the Level Synchro Recording as follows. Track numbers are automatically marked when the input signal is continuously below a certain level for more than two seconds and then exceeds that level.

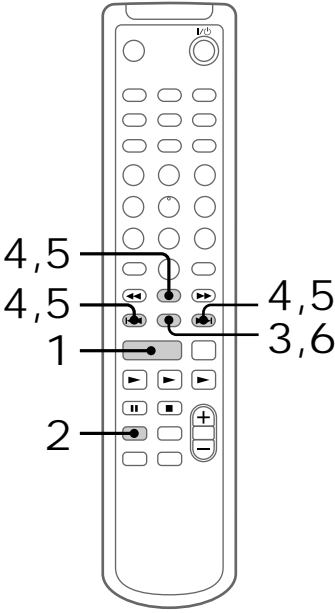

- 1 Press **FUNCTION** repeatedly until “AM” or “FM” appears.
To record from other components connected to this system, select “TAPE” or “ANALOG IN”.
- 2 Press **MD ● REC** to stand by for recording.
- 3 Press **MENU/NO** repeatedly until “Setup Menu” appears.
- 4 Press **–** or **+** repeatedly until “T.Mark Off” or “T.Mark LSync” appears, then press **ENTER/YES**.

5 Press **–** or **+** repeatedly until “T.Mark LSync” appears, then press **ENTER/YES**.
“L-SYNC” lights up.

6 Press **MENU/NO**.
To continue and record, follow the procedures described on the various recording pages.

To stop recording

Press ■

To change the trigger level for automatic track marking

Do the procedure below to change the signal level that triggers automatic track marking.

- 1 Press **MENU/NO** during recording pause.
“Setup ?” appears, then press **ENTER/YES**.
- 2 Press **–** or **+** repeatedly until “LS(T)” appears, then press **ENTER/YES**.
- 3 Press **–** or **+** repeatedly to select the level, then press **ENTER/YES**.
You can set the level at any value between –72 dB and 0 dB, in 2 dB steps.
- 4 Press **MENU/NO**.

To cancel automatic track marking

Press **–** or **+** repeatedly until “T.Mark Off” appears in step 5 above, then press **ENTER/YES**.

“L-SYNC” disappears. When “L-SYNC” is off, a track number is marked only at the beginning of each recording.

continued

Marking track numbers
(continued)

Marking track numbers at a specific point during recording — Track Mark

You can mark track numbers at any time during recording, regardless of the type of sound source.

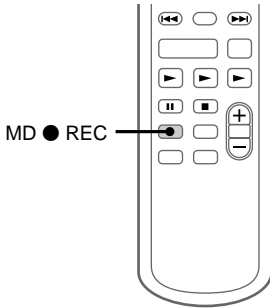

- ➔ Press MD ● REC during recording at the point you want to add a track mark. The tracks following the added one are renumbered.

Making a space between tracks 3 seconds long — Smart Space

The Smart Space function lets you make the blank spaces between tracks 3 seconds long automatically while making a digital recording from a CD. For other types of recording, if the Smart Space function is on and there is no sound input for about 3 seconds or more (but less than about 30 seconds) while recording, the MD deck replaces this silence with a blank of about 3 seconds and continues recording.

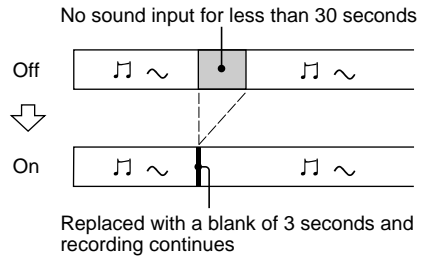

Auto Cut: When the Smart Space function is on, if there is no sound input for about 30 seconds or more, the MD deck replaces this silence with a blank of about 3 seconds and enters recording pause.

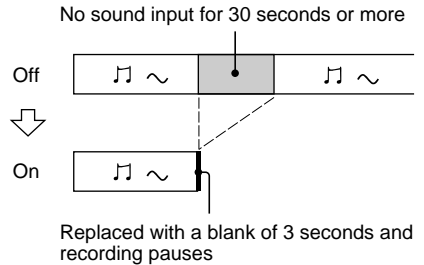

Setting Smart Space to on

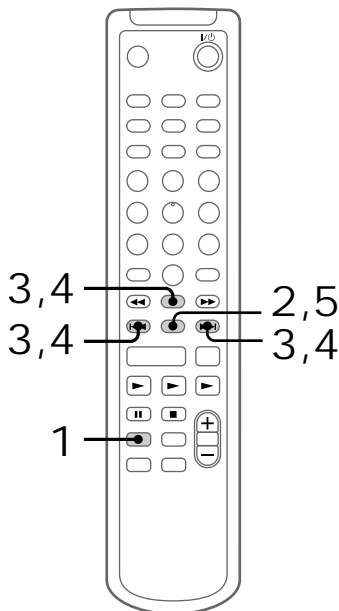

- 1 Press MD ● REC to stand by for recording.
- 2 Press MENU/NO repeatedly until “Setup Menu” appears.
- 3 Press – or + repeatedly until “S.Space Off” (or “S.Space On”) appears, then press ENTER/YES.

4 Press – or + repeatedly until “S.Space On” appears, then press ENTER/YES.

5 Press MENU/NO.

To continue and record, follow the procedures described on the various recording pages.

If there is an extended silence of less than about 30 seconds during recording, “Smart Space” appears, and the MD deck replaces the silence with a blank of about 3 seconds and continues recording.

If there is no sound input for about 30 seconds or more during recording, “Auto Cut” appears, and the MD deck replaces the silence with a blank of about 3 seconds and switches to recording pause. Press MD ► to restart the recording.

To turn off Smart Space and Auto Cut functions

Press – or + repeatedly until “S.Space Off” appears in step 4 above, then press ENTER/YES.

Tip

The Smart Space and Auto Cut functions are factory set to on. If you turn off the system or disconnect the power cord, the MD deck will retain the last setting (S.Space On or Off).

Adjusting the recording level

When recording on an MD, you can adjust the recording level to the desired volume. You can adjust the recording level not only when making an analog recording, but also when making a digital recording from a CD, etc.

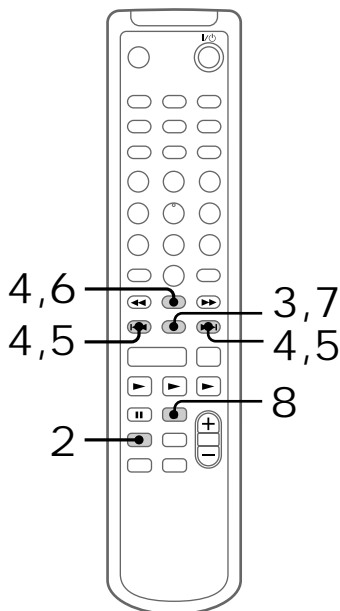

- 1 Prepare the desired sound source to record and start play.
- 2 Press MD ● REC to stand by for recording.

- 3 Press MENU/NO repeatedly until “Setup Menu” appears.
- 4 Press – or + repeatedly until “LevelAdjust?” appears, then press ENTER/YES.

- 5 Press – or + to adjust the recording level.

While monitoring the sound, adjust to the optimum level while making sure that “OVER” does not appear in the display at the loudest portion.

Adjust the level so that “OVER” does not appear

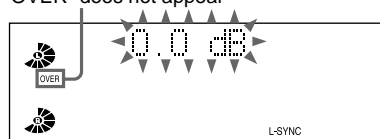

- 6 Press ENTER/YES.
- 7 Press MENU/NO.
- 8 Press ■ to cancel recording pause.
- 9 When a CD or other sound source is playing, stop playback.
To continue and record, follow the procedures described on the various recording pages.

Tips

- You can also adjust the recording level during recording.
- Once adjusted, the recording level is maintained until you adjust it again.

Before you start editing

You can edit the recorded tracks on an MD. By using the editing functions, you can create a new sequence to the recorded MD.

Editing functions

- **Name — Labeling MDs (page 38)**
Use this function to label discs and tracks. You can use upper case, lower case, numbers, and symbols for the titles.
- **Erase — Erasing recordings (page 40)**
Use this function to erase a single track one by one, all the tracks at once, or a portion of a track.
- **Move — Changing the order of tracks (page 43)**
Use this function to change the track numbering.
- **Divide — Adding track numbers (page 45)**
Use this function to add track numbers. This lets you locate your favorite phrases quickly.
- **Combine — Combining recorded tracks (page 46)**
By using this function, two tracks are combined to a single track. You can combine the tracks which are not numerically consecutive, i.e. the track 1 and track 4, etc.
- **Undo — Canceling the last edit (page 48)**
Use this function to cancel the last edit and restore the contents of the MD to the condition before the edit.
- **S.F Edit — Changing the recorded level (page 49)**
Use this function to change the recorded level. You can also select Fade-in or Fade-out recording.

Before editing

You can edit an MD only when:

- The MD is recordable.
- The MD play mode is normal play.

Check the following, before editing.

1 Check the tab of the MD to be edited.

If the MD is protected, “C11” and “Protected” appear alternately and the MD cannot be edited.

Slide the tab to close the slot.

2 Press PLAY MODE repeatedly until both “PROGRAM” and “SHUFFLE” disappear.

You can edit the MD only during normal play. You cannot edit the MD during Shuffle or Program Play.

After editing

- ➔ Press MD ▲ to remove the MD or press I /⏻ (power) to turn off the system. “TOC” lights up or starts flashing. The TOC is updated and editing is completed.

Before pulling out the power cord

MD editing is completed when the MD Table of Contents (TOC) is updated. The TOC is updated when you eject the MD or press I /⏻ to turn off the system. Do not pull out the power cord before updating the TOC (while “TOC” is lit) or while updating the TOC (while “TOC” is flashing) to ensure a complete editing.

Labeling an MD

— Name Function

You can create titles for your recorded MDs and tracks as follows.

During recording

If “TEXT” flashes in the display during recording a CD, you can record the track titles on the MD (see page 26).

After recording

Use Name Function on this page.

You can input a total of approximately 1700 characters for the disc title and track titles on a single MD.

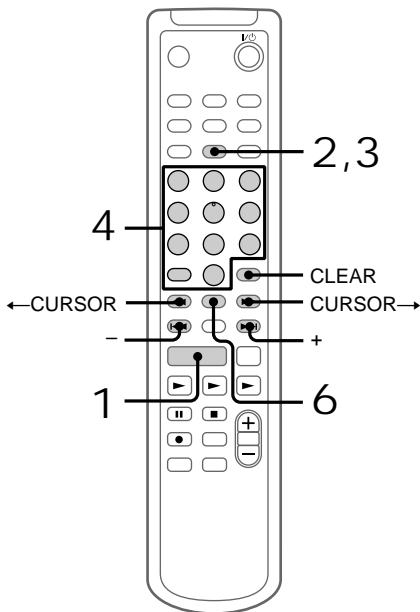

- 1 Press **FUNCTION** repeatedly to switch the function to MD.

To label a track, press **-** or **+** repeatedly until the desired track number appears.

- 2 Press **NAME EDIT/SELECT**.

The text input screen appears, and the cursor flashes.

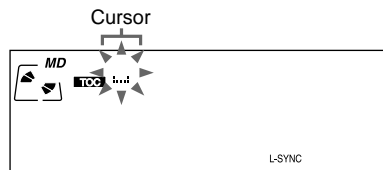

- 3 Press **NAME EDIT/SELECT** to select the desired type of character.

Each time you press the button, the display changes as follows:

Selected AB* (Upper cases) → Selected ab (Lower cases) → Selected 12 (Numbers) → Selected AB (Upper cases) → ...

* Press number 1 repeatedly to display the following symbols.

‘ - / , . () : ! ?

In addition, when the symbols above appear in the display, press **-** or **+** repeatedly to display the following symbols.

& + < > _ = ” ; # \$ % @ * `

- 4 Enter a character.

If you've selected uppercase or lowercase letters

- 1 Press the corresponding letter/number button repeatedly until the character to be entered flashes.

Or, press the button once and press **-** or **+** repeatedly.

- 2 Press **CURSOR**→.

The flashing character is entered and the cursor shifts to the right.

If you've selected numbers

Press the corresponding number button.

The number is entered and the cursor shifts to the right.

-
- 5 Repeat steps 3 and 4 to enter the rest of the name.

To change a character

Press ←CURSOR or CURSOR→ repeatedly until the character to be changed flashes, press CLEAR to erase the character, then repeat steps 3 and 4.

- 6 Press ENTER/YES to complete the labeling procedure.

The titles you labeled appear sequentially, and then the original display appears.

To cancel labeling

Press MENU/NO.

Notes

- You can label a track title during play. The playback repeats until you finish labeling.
- If the MD is record protected, “C11” and “Protected” appear alternately and the MD cannot be recorded. Remove the MD, then slide the record protection tab to the closed position (see page 24).

Copying a disc or track title

You can copy a labeled disc or track title to use it as a title of another track or the disc title within a disc.

- 1 Press MENU/NO in stop mode.
- 2 Press – or + repeatedly until “Name?” appears, then press ENTER/YES.
- 3 Press – or + repeatedly until “Nm Copy?” appears, then press ENTER/YES.
- 4 Press – or + repeatedly to select “Disc” (when copying the disc title) or the track number with the title you want to copy, then press ENTER/YES.
- 5 Press – or + repeatedly to select the copy destination track number or “Disc” (when copying as the disc title), then press ENTER/YES.

When “Overwrite??” appears

The copy destination already has a disc or track title. To continue and copy the title, press ENTER/YES.

To cancel copying

Press MENU/NO.

continued

Checking the titles

To check the disc titles, press **SCROLL** in stop mode. To check the track title, press **SCROLL** during play. The title appears scrolling in the display. To stop scrolling, press **SCROLL**. Press the button again to resume scrolling.

Erasing the titles

- 1 Press **MENU/NO** in stop mode.
- 2 Press **-** or **+** repeatedly until "Name?" appears, then press **ENTER/YES**.
- 3 Press **-** or **+** repeatedly until "Nm Erase?" appears, then press **ENTER/YES**.
- 4 Press **-** or **+** repeatedly until the desired title to erase appears, then press **ENTER/YES**.
"Complete!" appears and the title is erased.

To erase all the titles, press **-** or **+** repeatedly until "Nm All Ers?" appears, then press **ENTER/YES** twice after performing 1 and 2.

To cancel erasing

Press **MENU/NO**.

To return to the condition before labeling or erasing

You can return to the original condition immediately after labeling or erasing a title (see page 48).

Erasing recordings

— Erase Function

The MD deck lets you erase unwanted tracks quickly and easily. You can restore the contents to the condition before erasing (unerase) by using the Undo function. Note, however, you cannot undo an edit after performing any additional edits.

The three options for erasing recordings are:

- Erasing a single track. (Track Erase)
- Erasing all tracks. (All Erase)
- Erasing a portion of a track. (A-B Erase)

Erasing a single track (Track Erase Function)

You can erase a track simply by selecting its track number. When you erase a track, the total number of tracks on the MD decreases by one and all the tracks following the erased one are renumbered.

Eg.: Erasing track 2.

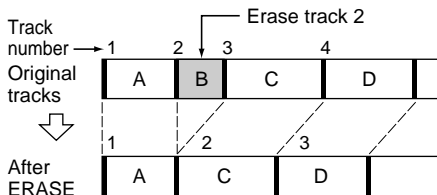

When erasing multiple tracks, you should proceed in order from high to low track number to prevent the renumbering of tracks that have not been erased yet.

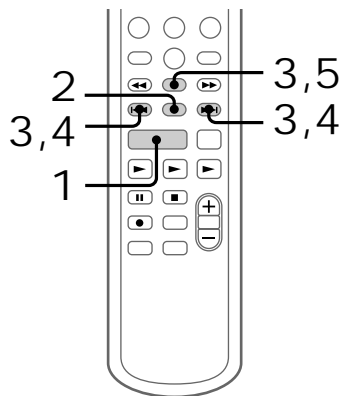

- 1 Press **FUNCTION** repeatedly to switch the function to MD.
- 2 Press **MENU/NO** to display “Edit Menu”.
- 3 Press **-** or **+** repeatedly until “Tr Erase?” appears, then press **ENTER/YES**.
- 4 Press **◀◀** or **▶▶** repeatedly until the desired track number appears.

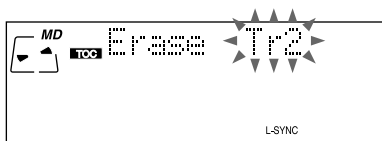

- 5 Press **ENTER/YES**.
“Complete!” appears for a few seconds and the selected track and title are erased.

To cancel erasing
Press **MENU/NO**.

Note
“Erase???” appears when the track was recorded or edited on another deck and is protected. To erase the track, press **ENTER/YES** while “Erase???” appears.

Erasing all tracks (All Erase Function)

You can erase the disc title, all recorded tracks and their titles at once.

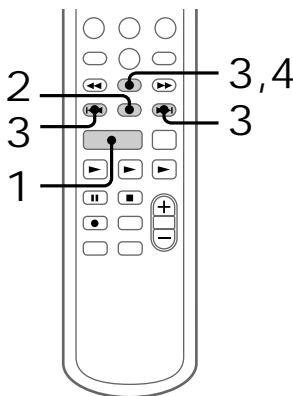

- 1 Press **FUNCTION** repeatedly to switch the function to MD.
- 2 Press **MENU/NO** to display “Edit Menu”.
- 3 Press **-** or **+** repeatedly until “All Erase?” appears, then press **ENTER/YES**.
“All Erase?” appears.
- 4 Press **ENTER/YES** again.
“Complete!” appears for a few seconds and the disc title, all recorded tracks and their titles are erased.

To cancel erasing
Press **MENU/NO**.

continued

Erasing a portion of a track (A-B Erase Function)

You can specify a portion within a track and erase the portion with ease. You can shift the desired portion by frame*, minute or second intervals. This function is convenient when erasing unnecessary sections after recording a satellite broadcast or FM broadcast.

* 1 frame is 1/86 second.

E.g.: Erasing a portion of track 2.

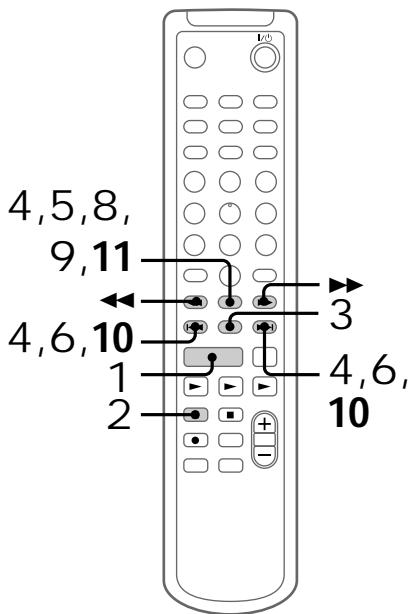
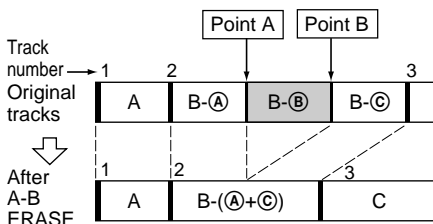

- 1 Press FUNCTION repeatedly to switch the function to MD.
- 2 While playing an MD, press **II** at the starting point of the portion to be erased (point A).
The MD pauses.
- 3 Press MENU/NO to display “Edit Menu”.
- 4 Press – or + repeatedly until “A-B Erase?” appears, then press ENTER/YES.
- 5 Press ENTER/YES again.
“—Rehearsal—” and “Point A ok?” appear alternately while the deck plays the selected track from the beginning to point A.
- 6 While monitoring the sound, press **IIII** or **IIII** repeatedly to find the starting point of the portion to be erased (point A).
You can shift the starting point by 1-frame* intervals (1 frame = 1/86 second).
To shift the point by second or minute intervals, press **◀** or **▶** so that second or minute flashes, then press **IIII** or **IIII**.
* You can shift the starting point by 2-frame intervals (tracks recorded in Monaural or LP2 Stereo mode) or by 4-frame intervals (tracks recorded in LP4 Stereo mode).
- 7 Repeat step 6 until point A is played correctly.

8 Press ENTER/YES if point A is correct. "Point B set" appears and playback for setting the ending point of the portion to be erased (point B) starts.

9 Continue playback until the deck reaches point B, then press ENTER/YES. "A-B Ers" and "Point B ok?" appear alternately and the deck repeats a portion of the few seconds before point A and after point B successively.

10 Press **⏮** or **⏭** repeatedly to find point B. The procedure is the same as step 6.

11 Press ENTER/YES if point B is correct. "Complete!" appears for a few seconds and the portion between point A and B is erased.

To cancel A-B Erase
Press MENU/NO.

Note
If "Impossible" appears, the specified portion cannot be erased. This happens when you have edited the same track many times. This is due to a technical limitation of the MD system and is not a mechanical error.

Moving recorded tracks

— Move Function

You can use this function to change the order of any track on the disc. When you move tracks, the tracks are automatically renumbered.

E.g.: Moving track 3 to position 2.

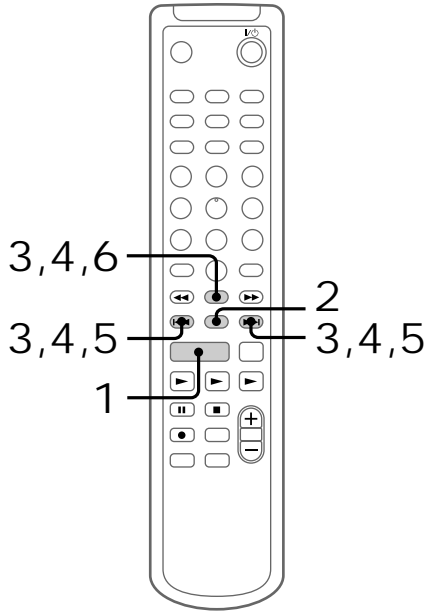
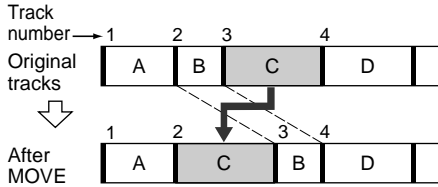

continued

Moving recorded tracks (continued)

- 1 Press FUNCTION repeatedly to switch the function to MD.
- 2 Press MENU/NO to display “Edit Menu”.
- 3 Press – or + repeatedly until “Move?” appears, then press ENTER/YES.
- 4 Press ◀◀ or ▶▶ repeatedly until the desired track number to move appears, then press ENTER/YES.
- 5 Press ◀◀ or ▶▶ repeatedly until the new track position appears.

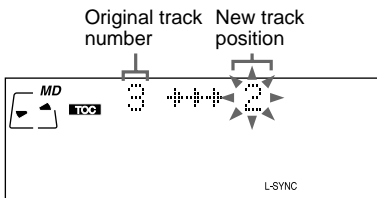

- 6 Press ENTER/YES.
“Complete!” appears for a few seconds and the selected track moves to the appointed position.

To cancel moving
Press MENU/NO.

To return to the track order
before MOVE

You can return to the original track order immediately after moving recorded tracks (see page 48).

Dividing recorded tracks

— Divide Function

You can use this function to mark track numbers after recording. The total number of tracks increases by one and all the tracks following the divided ones are renumbered.

E.g.: Dividing track 2 into two tracks.

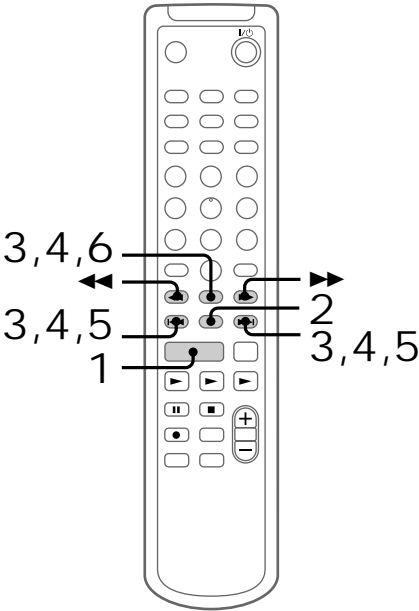
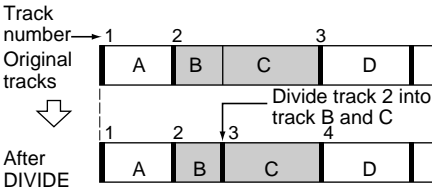

- 1 Press FUNCTION repeatedly to switch the function to MD.
- 2 Press MENU/NO to display “Edit Menu”.
- 3 Press – or + repeatedly until “Divide?” appears, then press ENTER/YES.
- 4 Press ◀◀ or ▶▶ repeatedly until the desired track number to divide appears, then press ENTER/YES.
“—Rehearsal—” appears and the portion to be divided is played repeatedly.
- 5 While monitoring the sound, press ◀◀ or ▶▶ repeatedly to adjust the point to be divided.
You can shift the point by 1-frame* intervals (1 frame = 1/86 second).
To shift the point by second or minute intervals, press ◀◀r ▶▶ so that second or minute flashes, then press ◀◀ or ▶▶.
* You can shift the point by 2-frame intervals (tracks recorded in Monaural or LP2 Stereo mode) or by 4-frame intervals (tracks recorded in LP4 Stereo mode).
- 6 Press ENTER/YES.
“Complete!” appears for a few seconds and the newly created track starts playing.

To cancel dividing
Press MENU/NO.

continued

Dividing recorded tracks (continued)

To return to the condition before DIVIDE

You can return to the original condition immediately after dividing the tracks (see page 48). You can also return to the original condition by using the Combine Function (see this page).

Notes

- If you divide a labeled track (page 38) into two tracks, only the first track retains the track title.

E.g.:

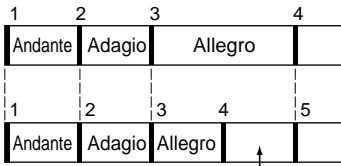

The new track is not labeled

- “Impossible” appears, when you specify the division point at the beginning or end of a track. Press – or + to shift the position.

Combining recorded tracks — Combine Function

You can use this function to combine 2 tracks into a single track. The total number of tracks decreases by one and all tracks following the combined ones are renumbered.

E.g.: Combining track 3 to track 1.

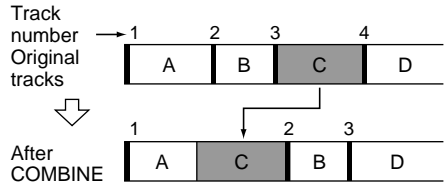

E.g.: Combining track 1 to track 4.

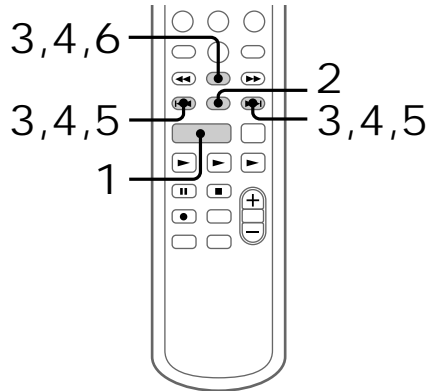
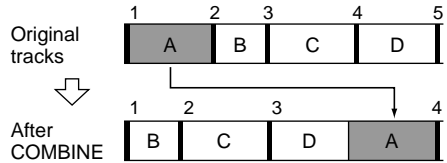

1 Press **FUNCTION** repeatedly to switch the function to MD.

2 Press **MENU/NO** to display “Edit Menu”.

3 Press **-** or **+** repeatedly until “Combine?” appears, then press **ENTER/YES**.

4 Press **◀◀** or **▶▶** repeatedly until the first track number of the two to be combined appears, then press **ENTER/YES**.

For example, to combine tracks 4 and 5, select 4.

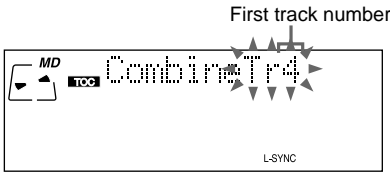

5 Press **◀◀** or **▶▶** repeatedly until the second track number of the two to be combined appears.

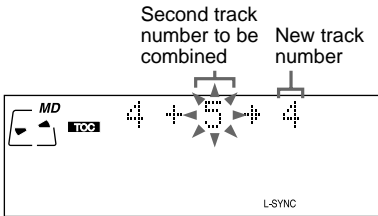

6 Press **ENTER/YES**.
“Complete!” appears for a few seconds and the tracks are combined. Play starts.

To cancel combining
Press **MENU/NO**.

To return to the condition before **COMBINE**

You can return to the original condition immediately after combining the tracks (see the next page). You can also return to the original condition by using the Divide function.

Notes

- Tracks recorded in different recording modes (stereo, LP2, LP4 or MONO) cannot be combined.
- If both of the combined tracks have track titles, the title of the second track is erased.
- If “Impossible” appears, the tracks cannot be combined. This happens when you have edited the same track many times. This is due to a technical limitation of the MD system and is not a mechanical error.

Undoing the last edit

— Undo Function

You can use this function to cancel the last edit and restore the contents of the MD to the condition before the edit.

Note, however, that you cannot undo an edit if you do any of the following after the edit:

- Do another edit.
- Start recording.
- Update the TOC by turning off the system or ejecting the MD.
- Disconnect the power cord.

You cannot undo the S.F Edit Function even if you use the Undo Function.

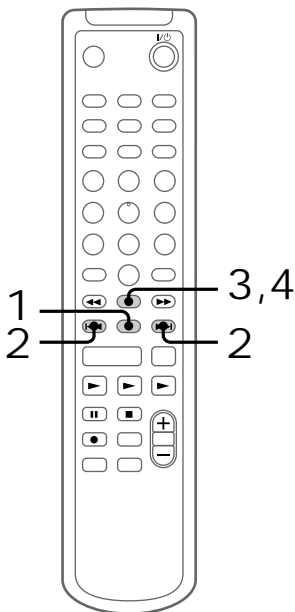

- 1 Press MENU/NO in stop mode to display “Edit Menu”.

- 2 Press – or + repeatedly until “Undo?” appears.

“Undo?” does not appear, when there is no editing function that can be canceled.

- 3 Press ENTER/YES.

One of the following messages appears, depending on the last edit.

Editing done	Message
Labeling a track or an MD	
Copying a disc or track title	“Name Undo?”
Erasing labeled titles	
Erasing a single track	
Erasing all tracks	“Erase Undo?”
Erasing a portion of a track	
Moving a track	“Move Undo?”
Dividing a track	“Divide Undo?”
Combining tracks	“Combine Undo?”

- 4 Press ENTER/YES again.

“Complete!” appears for a few seconds and the contents of the MD are restored to the condition before the edit.

To cancel Undo function

Press MENU/NO.

Changing the recorded level after recording

— S.F Edit Function

You can change the volume of recorded tracks using S.F (Scale Factor) Edit. The original track is recorded over at the new recording level. When changing the recording level, you can select Fade-in Recording to gradually increase the signal level at the start of recording, or Fade-out Recording to gradually decrease the signal level at the end of the recording.

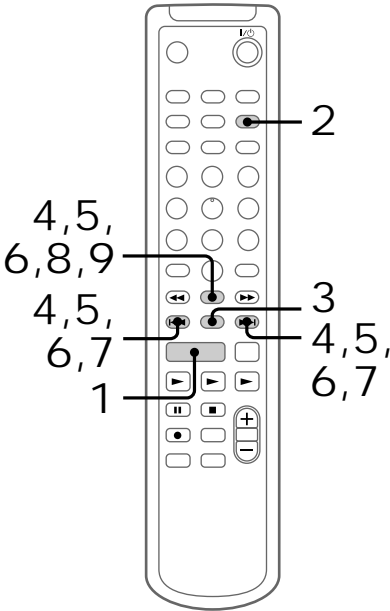

Changing the overall recording level

- 1 Press FUNCTION repeatedly to switch the function to MD.
- 2 Press PLAY MODE repeatedly until both “SHUFFLE” and “PROGRAM” disappear.
- 3 Press MENU/NO to display “Edit Menu”.
- 4 Press – or + repeatedly until “S.F Edit?” appears, then press ENTER/YES.
- 5 Press – or + repeatedly until “Tr Level?” appears, then press ENTER/YES.
- 6 Press – or + repeatedly until the track number you want to change the recording level appears, then press ENTER/YES.
“Level 0dB” appears in the display.

continued

Changing the recorded level after recording (continued)

- 7 Press – or + repeatedly to change the recorded level.

The recording level can be changed from –12 dB to +12 dB, in 2 dB increments. While monitoring the sound, change to the optimum level while making sure that “OVER” does not appear in the display at the loudest portion.

Adjust the level so that “OVER” does not appear

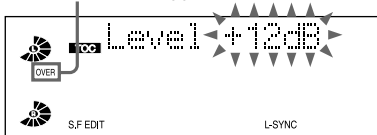

- 8 Press ENTER/YES.
“S.F Edit OK?” appears in the display.

- 9 Press ENTER/YES.
The deck starts recording over the existing track. “S.F Edit: ** %” appears while the track is being recorded. An amount of time that is roughly equal to or longer than the playback time of the track is required when recording over the track. When the recording finishes, “Complete!” appears in the display for a few seconds.

Fade-in and Fade-out Recording

- 1 Press FUNCTION repeatedly to switch the function to MD.
- 2 Press PLAY MODE repeatedly until both “SHUFFLE” and “PROGRAM” disappear.
- 3 Press MENU/NO to display “Edit Menu”.
- 4 Press – or + repeatedly until “S.F Edit?” appears, then press ENTER/YES.
- 5 Press – or + repeatedly until “Fade In?” or “Fade Out?” appears, then press ENTER/YES.
- 6 Press ◀◀ or ▶▶ repeatedly until the track number you want to change the recording level appears, then press ENTER/YES.
“Time 5.0s” appears in the display.

-
- 7** Press – or + repeatedly to change the Fade-in or Fade-out recording time. The system plays the portion that will be recorded over using Fade-in or Fade-out Recording. You can set the time at any value between 1.0 second and 15.0 seconds, in 0.1 second increments. You cannot set the time longer than the track.

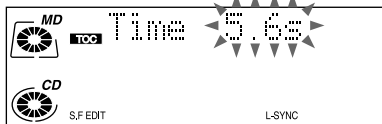

-
- 8** Press ENTER/YES. “S.F Edit OK?” appears in the display.

-
- 9** Press ENTER/YES. The deck starts recording over the existing track. “S.F Edit: ** %” appears while the track is being recorded. When the recording finishes, “Complete!” appears in the display for a few seconds.
-

To cancel the operation

Press MENU/NO in steps 4 to 8. If you press ENTER/YES in step 9 and recording starts, you cannot interrupt the operation.

Notes

- You cannot change the recorded level of a track recorded in LP2 or LP4 mode.
- Do not disconnect the power cord or move the system while recording is in progress. This may damage the recording data preventing recording from being performed properly.
- Do not use an MD that is damaged or dirty. This may prevent recording data from being recorded properly.
- Repeatedly changing the recording level results in poor sound quality.
- The recording level will not return to the exact original level once the recording level has been changed even if it returned to the original level.
- The recording level cannot be changed while the timer is activated.
- You cannot undo the S.F Edit Function even if you use the Undo Function.

Reinforcing the bass sound — DBFB

You can listen to music with stronger bass tones or a more powerful sound.

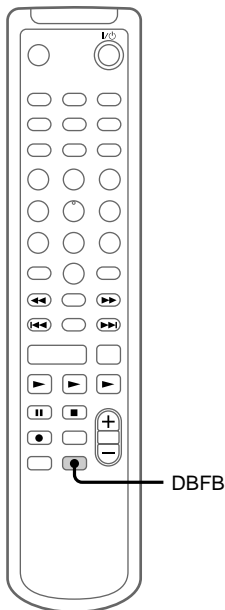

- ➔ Press DBFB*.
“DBFB” appears in the display.
Press again to cancel DBFB.

* DBFB: Dynamic Bass Feedback

Tip

DBFB is factory set to on.

Selecting the Preset Equalizer menu

The Preset Equalizer enables you to select the sound characteristic among 5 sound effects according to the type of music you are listening to.

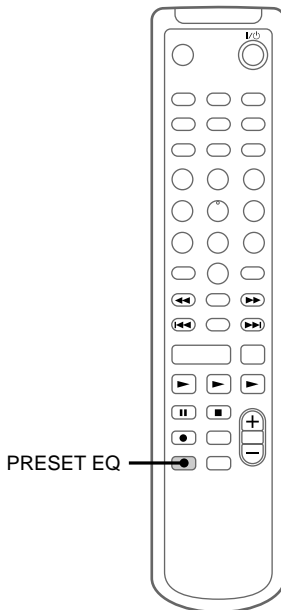

- ➔ Press PRESET EQ repeatedly.
Each time you press the button, the display changes as follows:

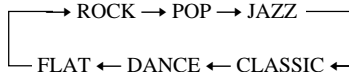

To cancel the Preset Equalizer
Press PRESET EQ repeatedly until “FLAT” appears.

Tips

- The Preset Equalizer menu is factory set to “ROCK.”
- The Preset Equalizer effect is not recorded on an MD or a tape.

Labeling the preset stations — Station Name

You can label each preset station with up to 10 characters (Station Name). The Station Name appears when you tune in the station.

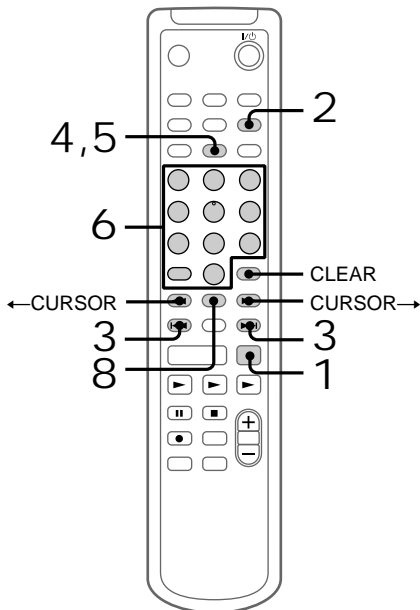

- 1 Press TUNER/BAND to select “FM” or “AM”.
- 2 Press TUNING MODE repeatedly until “PRESET” appears.
- 3 Press – or + repeatedly until the desired preset station to label appears.

- 4 Press NAME EDIT/SELECT on the remote.
The text input screen appears, and the cursor flashes.

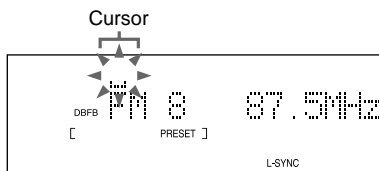

- 5 Press NAME EDIT/SELECT on the remote repeatedly to select the desired type of character.
Each time you press the button, the display changes as follow:
Selected AB* (Upper cases) → Selected ab (Lower cases) → Selected 12 (Numbers) → Selected AB (Upper cases) → ...
* Press number 1 repeatedly to display the following symbols.
' - / , . () : ! ?
In addition, when the symbols above appear in the display, press – or + repeatedly to display the following symbols.
& + < > _ = " ; # \$ % @ * ` `

- 6 Enter a character.
If you've selected uppercase or lowercase letters
1 Press the corresponding letter/number button repeatedly until the character to be entered flashes.
Or, press the button once and press – or + repeatedly.
2 Press CURSOR→.
The flashing character is entered and the cursor shifts to the right.

If you've selected numbers
Press the corresponding number button.
The number is entered and the cursor shifts to the right.

continued

Labeling the preset stations (continued)

- 7 Repeat steps 5 and 6 to enter the rest of the name.

To change a character

Press ←CURSOR or CURSOR→ repeatedly until the character to be changed flashes, press CLEAR to erase the character, then repeat steps 5 and 6.

- 8 Press ENTER/YES to complete the labeling procedure.

To cancel labeling

Press MENU/NO.

To check the station name

Each time you press DISPLAY, the display changes as follows:

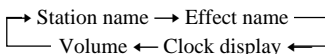

To erase the name

- 1 Repeat steps 1 to 4.
- 2 Press CLEAR repeatedly to erase the name.
- 3 Press ENTER/YES.

Using the Radio Data System (RDS)

(European model only)

What is the Radio Data System?

Radio Data System (RDS) is a broadcasting service that allows radio stations to send additional information along with the regular programme signal. RDS is available only on FM stations*.

Note

RDS may not work properly if the station you are tuned in is not transmitting the RDS signal properly or if the signal is weak.

* Not all FM stations provide RDS service, nor do they provide the same types of services. If you are not familiar with the RDS system, check with your local radio stations for details on RDS services in your area.

Receiving RDS broadcasts

- ➔ Simply select a station from the FM band.

When you tune in a station that provides RDS services, the station name appears in the display.

To check the RDS information

Each time you press DISPLAY, the display changes as follows:

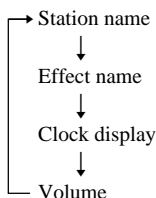

Falling asleep to music

— Sleep Timer

You can set the system to turn off after a certain time, so that you can fall asleep to music. You can preset the time to turn off in 10 minutes increments.

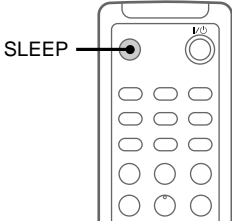

➔ Press SLEEP.

Each time you press the button, the minute display (the turn-off time) changes as follows:

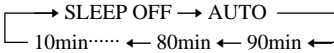

If you select "AUTO"

The system turns off after about 4 hours.
The system also turns off automatically when the current CD or MD finishes playing.

To check the remaining time

Press SLEEP once.

To change the time to turn off

Select the time you want by pressing SLEEP.

To cancel the Sleep Timer function

Press SLEEP repeatedly until "SLEEP OFF" appears.

Tip

You can use the Sleep Timer, even if you have not set the clock.

Note

Do not set to "AUTO" during CD-MD Synchro Recording.

Waking up to music

— Daily Timer

You can wake up to music at a preset time. Make sure you have set the clock (see page 6).

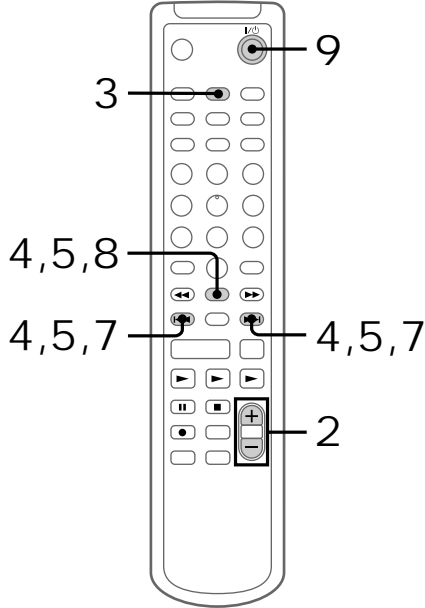

1 Prepare the sound source you want to play.

- CD: Place a CD. To start from a specific track, make a program (see page 16).
- MD: Insert an MD. To start from a specific track, make a program (see page 21).
- Radio: Tune in a station (see page 7).
- Tape: Insert a tape in the optional tape deck TC-TX595.

2 Press VOLUME +/- to adjust the volume.

3 Press CLOCK/TIMER SET.

continued

Waking up to music (continued)

-
- 4 Press – or + repeatedly until “DAILY SET?” appears, then press ENTER/YES.

The hour indication flashes.

-
- 5 Set the time to start play.
Press – or + repeatedly to set the hour, then press ENTER/YES.

The minute indication flashes.



Press – or + repeatedly to set the minute, then press ENTER/YES.

The hour indication flashes again.

-
- 6 Set the time to stop play following the above procedure.

-
- 7 Press – or + repeatedly to select the desired sound source.

The indication changes as follows:

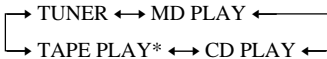

* Select this to use another component (the optional tape deck TC-TX595) as the sound source.

-
- 8 Press ENTER/YES.

The start time, the stop time, the sound source and volume appear in turn, before the original display returns.

-
- 9 Press I/⏻ to turn off the system.
-

To change the setting

Start over from step 1.

If you made a mistake, press ←CURSOR and return to the point you want to change during steps 5 to 7, then change the setting.

To check the setting/activate the timer

- 1 Press CLOCK/TIMER SELECT, then press – or + repeatedly until “DAILY SELECT?” appears.
- 2 Press ENTER/YES.

To cancel the timer

Press CLOCK/TIMER SELECT, then press – or + repeatedly until “TIMER OFF?” appears. Then press ENTER/YES.

Tip

When you connect the optional tape deck TC-TX595 to the system, you can activate the tape deck using the Daily Timer function without setting the timer on the tape deck.

Notes

- You cannot activate Daily Timer and recording timer at the same time.
- When you use the Daily Timer at the same time as the Sleep Timer, the Sleep Timer setting has priority.
- Do not operate the system from the time the system turns on until the play starts (about 30 seconds before the preset time).
- If you use another component (except for the optional tape deck TC-TX595), you must set the timer on both systems to the same time.
- You cannot use the components connected to the DIGITAL OPTICAL IN jack or ANALOG IN jack as the sound source for Daily Timer.

Timer recording radio programs

To timer record, you must first preset the radio station (see page 7) and set the clock (see page 6).

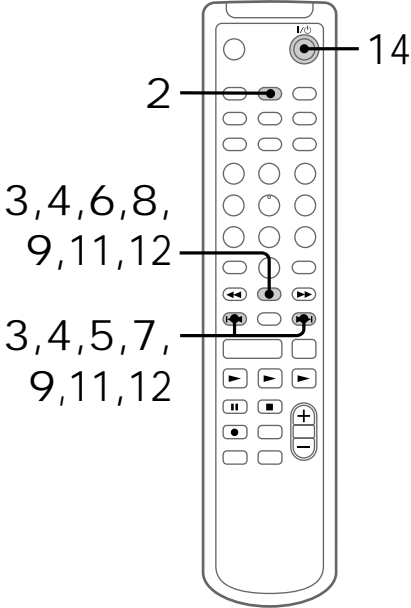

- 1 Tune in the preset radio station (see page 12).
- 2 Press **CLOCK/TIMER SET**.
- 3 Press **-** or **+** repeatedly until “REC SET?” appears, then press **ENTER/YES**.
- 4 Press **-** or **+** repeatedly to select one of “REC 1” to “REC 3”, then press **ENTER/YES**.

- 5 Press **-** or **+** repeatedly until “ONCE?”, “DAILY?” or “WEEKLY?” appears.
If you select “ONCE?”, the recording timer activates only once. If you select “DAILY?”, the timer activates at the same time every day. If you select “WEEKLY?”, the timer activates at the same time on the set day of every week.

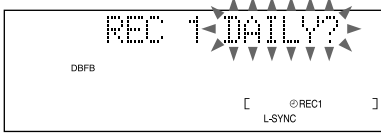

- 6 Press **ENTER/YES**.
If you select “ONCE?” or “WEEKLY?”, the day indication starts flashing. If you select “DAILY?”, the hour indication starts flashing.

- 7 Press **-** or **+** repeatedly to select the desired day.
If you select “DAILY?” in step 5, proceed to step 9.



- 8 Press **ENTER/YES**.
The hour indication flashes.

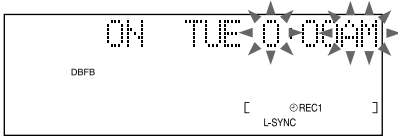

For models using a 12-hour system, noon is indicated as 0:00 PM, and midnight as 0:00 AM.

continued

Timer recording radio programs (continued)

9 Set the time to start recording.

Press – or + repeatedly to set the hour, then press ENTER/YES.

The minute indication flashes.

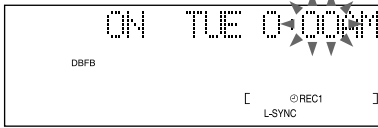

Press – or + repeatedly to set the minute, then press ENTER/YES.

The hour indication flashes again.

10 Set the time to stop recording following the procedure in step 9.

11 Select the recording destination.

Press – or + repeatedly to select “TUNER → MD” or “TUNER → TAPE”.

12 When you record onto an MD, select the recording mode (e.g., LP2) by pressing – or +, then press ENTER/YES.

The timer recording settings appear, then the original display returns.

13 Insert a recordable MD or tape.

If you use a partially recorded MD, recording starts after the recorded tracks.

14 Press I/⏻ to turn off the system.

To change the setting

Start over from step 1.

To activate/cancel the timer

- 1 Press CLOCK/TIMER SELECT, then press – or + repeatedly until “REC SELECT?” appears and press ENTER/YES.
- 2 Press ◀ or ▶ repeatedly to select the timer number (REC 1 to 3), then press – or + repeatedly to select the timer number (set) or “–” (cancel) and press ENTER/YES. If you have not set the recording timer, “–” appears instead of the timer number or “–”.

To check the timer

Select the timer number (REC 1 to 3) in step 2 of “To activate/cancel the timer”, then press ENTER/YES.

The last setting appears.

Tip

When you record from the radio, the station name (see page 53, or frequency when the station is not labeled), the start time and the stop time are automatically recorded on the MD.

Notes

- You cannot activate Daily Timer and the recording timer at the same time.
- Do not operate the system from the time the system turns on until the recording starts (about 30 seconds before the preset time).
- When you record on a brand new MD, the first 15 seconds are not recorded.
- If the system is on about 30 seconds before the preset time, the timer-recording will not be activated.
- The volume is reduced to minimum during recording.
- If you use another component (except for the optional tape deck TC-TX595), you must set the timer on both systems to the same time. You cannot activate the component with this system’s timer.

Connecting optional components

Connecting optional A/V components

To enhance your system, you can connect optional components. Refer to the operating instructions of each component.

Connecting the audio cords (not supplied)

When using audio cords (not supplied) to connect other A/V components to the system, make sure to insert the plugs firmly, pushing them in all the way. No sound will be produced if the plugs are not inserted securely.

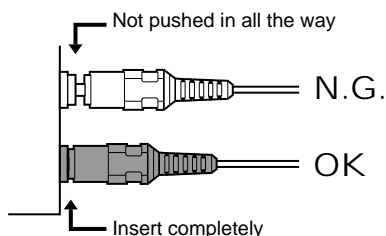

Connecting a portable MD, etc.

Connect a portable MD, etc., to the ANALOG IN jack on the front panel of the unit, using an audio connecting cord (not supplied).

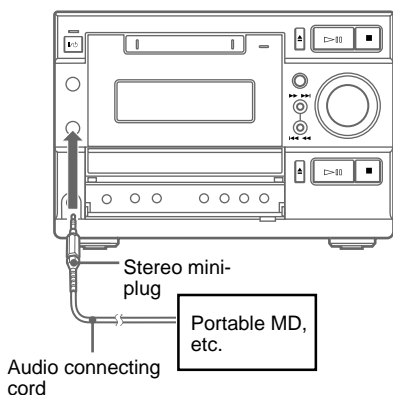

Connecting the optional TC-TX595 tape deck (European model only)

CD-TAPE Synchro Recording and Timer Recording are possible when the TAPE CONTROL jack is connected. Refer to the operating instructions included with the TC-TX595 tape deck for details.

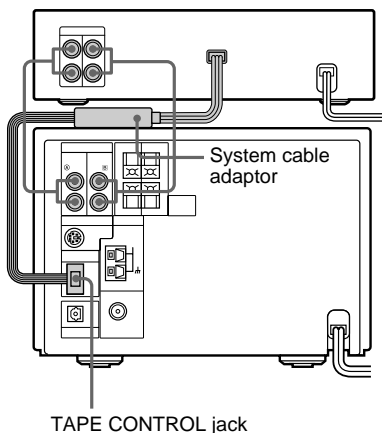

Tip

The **A** and **B** markings of the TAPE IN/OUT jacks guide you to connect the optional TC-TX595 tape deck.

Connecting another tape deck

Connect a tape deck to the TAPE IN and OUT jacks on the rear panel of the unit, using audio connecting cords (not supplied).

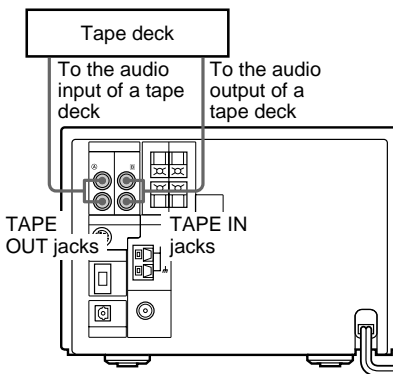

continued

Connecting optional A/V components (continued)

Connecting a CS/BS digital tuner, etc.

Connect the component to the DIGITAL OPTICAL IN jack on the rear panel of the unit, using a digital connecting cable (square, not supplied).

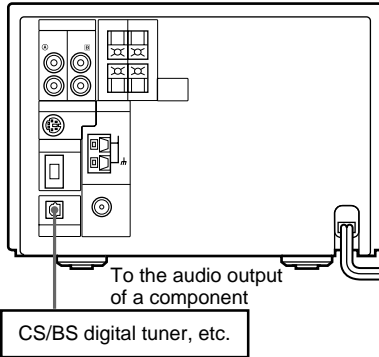

Connecting external antennas

Connect an outdoor antenna to improve reception.

FM antenna

Connect an commercially available FM outdoor antenna, or you can use a TV antenna instead.

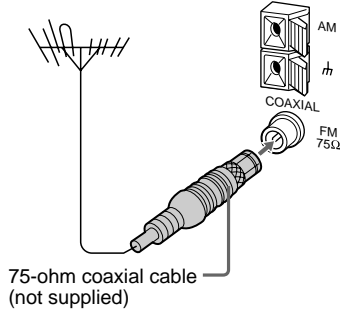

AM antenna

Connect a 6- to 15- meter (20- to 50- feet) insulated wire to the AM antenna terminal. Leave the supplied AM loop antenna connected.

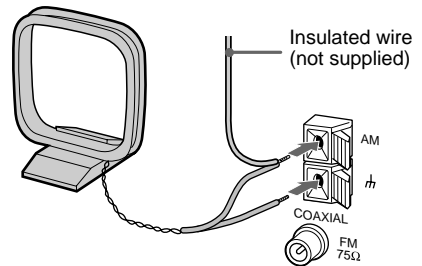

Important

If you connect an outdoor antenna, connect a ground wire to the \hbar terminal. To prevent a gas explosion, do not connect the ground wire to a gas pipe.

Precautions

On operating voltage

- Before operating the system, check that the operating voltage of your system is identical with the voltage of your local power supply.
- The voltage selector is located at the bottom of the apparatus.

On safety

- The unit is not disconnected from the AC power source (mains) as long as it is connected to the wall outlet, even if the unit itself has been turned off.
- Unplug the system from the wall outlet (mains) if it is not to be used for an extended period of time. To disconnect the cord (mains lead), pull it out by the plug. Never pull the cord itself.
- Should any solid object or liquid fall into the system, unplug the system and have it checked by qualified personnel before operating it any further.
- AC power cord (mains lead) must be changed only at the qualified service shop.
- When you connect the power cord to the wall outlet, even if the power is off, the system begins charging for remote and timer functions. Therefore the surface of this unit become warm, this is normal.

On placement

- Make sure the system fan is on during use. Place the system in a location with adequate air circulation, and do not place anything on top of the system.
- Place the system in a location with adequate ventilation to prevent heat build up.
- Do not place the system in an inclined position.
- Do not place the system in locations where it is;
 - Extremely hot or cold
 - Dusty or dirty
 - Very humid
 - Subject to vibrations
 - Subject to direct sunlight.

On installing

When you move the system, remove the CD or MD.

On operation

- If the system is brought directly from a cold to a warm location, or is placed in a very damp room, moisture may condense on the lens inside the CD player or the MD deck. Should this occur, the system will not operate properly. Remove the CD or MD and leave the system turned on for about an hour until the moisture evaporates.
- When you move the system, take out any discs.

If you have any questions or problems concerning your system, please consult your nearest Sony dealer.

On the speaker system

This speaker system is not magnetically shielded and the picture on TV sets may become magnetically distorted. In such a case, turn off the power of the TV set once, and after 15 to 30 minutes turn it on again.

If there seems to be no improvement, locate the speaker system further away from the TV set. Also, be sure not to place objects in which magnets are attached or used near the speaker system, such as audio racks, TV stands, and toys. These may cause magnetic distortion to the picture due to their interaction with the system.

Notes on MDs

- If you try to force the shutter open, the disc may be damaged. If the shutter opens, close it immediately without touching the disc inside.
- Affix the label supplied with the disc only to the specified label indentation. Do not affix the label around the shutter or in other locations. Note that the shape of the indentation depends on the disc.

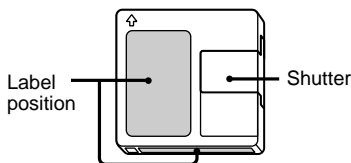

- Wipe the disc cartridge with a dry cloth to remove dirt.
- Do not expose the MD to direct sunlight or heat sources such as hot air ducts, nor leave it in a car parked in direct sunlight.

continued

Precautions (continued)

Notes on CDs

- Before playing, clean the CD with a cleaning cloth. Wipe the CD from the centre out.
- Do not use a CD with tape, seals, or paste on it as this may damage the player.
- Do not use solvents such as benzine, thinner, commercially available cleaners, or antistatic spray intended for vinyl LPs.
- Do not expose the CD to direct sunlight or heat sources such as hot air ducts, nor leave it in a car parked in direct sunlight.

Cleaning the cabinet

Use a soft cloth slightly moistened with mild detergent solution.

System limitations of MDs

The recording system in your MD deck has the limitations described below.

Note, however, that these limitations are due to the inherent nature of the MD recording system itself, not to mechanical causes.

“Disc Full!” appears before the MD has reached the maximum recording time

When 255 tracks have been recorded on the MD, “Disc Full!” appears regardless of the total recorded time. More than 255 tracks cannot be recorded on the MD. To continue recording, erase unnecessary tracks or use another recordable MD.

“Disc Full!” appears before the maximum number of tracks (255) is reached

Fluctuations in emphasis within tracks are sometimes interpreted as track intervals, increasing the track count and causing “Disc Full!” to appear.

The remaining recording time does not increase even after erasing numerous short tracks

Tracks shorter than 12 seconds* are not counted, so erasing them may not increase the recording time.

* During stereo recording, (approximately 24 seconds during monaural and LP2 stereo recording, or 48 seconds during LP4 stereo recording)

Some tracks cannot be combined with others

Tracks may not be combined if they have been edited.

The total recorded time and the remaining time on the MD do not add up to the maximum recording time

Recording is done in minimum units of 2 seconds* each, no matter how short the material. The recorded contents may be shorter than the maximum recording capacity. Disc space may also be reduced by scratches.

* During stereo recording, (approximately 4 seconds during monaural and LP2 stereo recording, or 8 seconds during LP4 stereo recording)

The sound may drop-out while searching the edited tracks

Tracks created through editing may exhibit sound dropout during searching because high-speed playback requires time to search for the position on the disc when the tracks are not in order.

Track numbers cannot be marked

When "L-SYNC" (page 32) lights up in the display window during analog recording, the track numbers may not be marked at the beginning of the track:

- if the input signal is below a certain fixed level for less than 2 seconds between tracks.
- if the input signal is below a certain fixed level for more than 2 seconds in the middle of the track.
- if you record a track that is 4 seconds or less*.

* During Stereo, Monaural or LP2 Stereo recording mode. (In LP4 Stereo recording mode: 8 seconds or less)

Extra tracks are created

When there is a long silence between CD tracks, an extra track may be created.

Guide to the Serial Copy Management System

Digital audio components, such as CDs, MDs, and DATs let you copy music easily with high quality by processing music as a digital signal.

To protect the copyrighted music programs, this system uses the Serial Copy Management System that allows you to make only a single copy of a digitally recorded source through digital-to-digital connections.

You can make only a first generation copy* through a digital-to-digital connection.

For example:

1 You can make a copy of a commercially available digital sound program (for example, a CD or MD), but you cannot make a second copy from the first-generation copy.

2 You can make a copy of a digital signal from a digitally recorded analog sound program (for example, an analog record or a music cassette tape) or from a digital satellite broadcast program, but you cannot make a second copy.

* A first-generation copy means a digital recording of a digital signal made on digital audio equipment. For example, if you record from this system's CD player to the MD deck, you make a first-generation copy.

Note

This copy management system doesn't apply when you make a recording through analog-to-analog connections.

Troubleshooting

If you have any problem using this system, use the following checklist.

First, check that the power cord is connected firmly and that the speakers are connected correctly and firmly.

Should any problem persist, consult your nearest Sony dealer.

General

There is no sound.

- Turn VOLUME clockwise.
 - Make sure the headphones are not connected.
 - Check the speaker connections (see page 4).
 - High-Speed CD-MD Synchro Recording is underway.
-

Sound comes from one channel, or unbalanced left and right volume.

- Connect the speaker cords properly (see page 4).
 - Place the speakers as symmetrically as possible.
 - Connect only one of the supplied speakers to each set of speaker terminals.
 - Connect the supplied speakers.
-

There is severe hum or noise.

- Move the system away from the source of noise.
 - Connect the system to a different wall outlet.
 - Install a noise filter (commercially available) to the power line.
-

“--:--” (for the European model) or
“--:-- AM” (for other models) appears in
the display.

- Set the clock again (see page 6).
-

The timer cannot be set.

- Set the clock again (see page 6).
-

The timer does not function.

- Press CLOCK/TIMER SELECT to set the timer and light up “DAILY” or “REC 1 (to 3)” in the display (see pages 55 and 57).
 - Check the set contents and set the correct time (see pages 55 – 57).
 - Connect the system cable adapter to the optional TC-TX595 tape deck properly (see page 59).
 - Refer to the operating instructions included with the connected component, and set the timer to the same time as the system’s timer.
-

The remote does not function.

- Remove the obstacle.
 - Move the remote closer to the system.
 - Point the remote at the system’s sensor.
 - Replace the batteries (R6/size AA).
 - Locate the system away from the fluorescent light.
-

CD Player

The CD tray does not close.

- Place the CD correctly in the center of the tray.
 - Always close the tray by pressing CD ▲. Trying to press the tray closed with your fingers may cause problems with the CD player.
-

The CD does not eject.

- Consult your nearest Sony dealer.
-

Play does not start.

- Open the CD tray and check whether a CD is loaded.
- Wipe the CD clean (see page 62).
- Replace the CD.
- Place the CD correctly in the center of the tray.
- Place the CD in the tray with the label side up.
- Remove the CD and wipe away the moisture on the CD, then leave the system turned on for a few hours until the moisture evaporates.
- Press CD ▷▶▶ to start play.

The sound skips.

- Wipe the CD clean (see page 62).
- Replace the CD.
- Try moving the system to a place without vibration (e.g., on top of a stable stand).
- Try moving the speakers away from the system, or placing them on separate stands. When you listen to a track with bass sounds at high volume, the speaker vibration may cause the sound to skip.

Play does not start from the first track.

- Press PLAY MODE repeatedly until “PROGRAM” or “SHUFFLE” disappears to return to normal play.

“—OVER—” appears.

- Keep pressing MD/CD ◀◀◀◀ to return to the desired playing position.

MD Deck

An MD cannot be inserted.

- Insert the MD with the arrow side up and the arrow pointing toward the deck.

The controls do not work.

- Replace the MD with a new one.
- Retry the operations after “TOC” turns off.

Play does not start.

- Replace the MD.
- Insert the MD and leave the system turned on for a few hours until the moisture evaporates.
- Press MD ▷▶▶ to start play.

The sound skips.

- Replace the MD.
- Try moving the system to a place without vibration (e.g., on top of a stable stand).
- Try moving the speakers away from the system, or placing them on separate stands. When you listen to a track with bass sounds at high volume, the speaker vibration may cause the sound to skip.
- Insert the disc and wait for 10 to 20 minutes with the system turned on.

Play does not start from the first track.

- Press PLAY MODE repeatedly until “PROGRAM” or “SHUFFLE” disappears to return to normal play.

“—OVER—” appears.

- Keep pressing MD/CD ◀◀◀◀ to return to the desired playing position.

“OVER” lights up during recording.

- Set the volume of the connected component lower.

Recording or editing was done, but the TOC is not updated.

- MD recording and editing contents are recorded to the MD when the MD is removed, so make sure you remove the MD after recording or editing (see pages 24 and 37).

Recording is not possible.

- Remove the MD and slide the tab to close the slot (see page 24).
- Connect the optional A/V component properly (see pages 59 and 60).
- Switch to another sound source.
- Replace the MD with a recordable MD, or use the Erase Function to erase unnecessary tracks (see pages 40 – 43).
- Start recording over from the beginning.

continued

The sound from an MD you recorded is too low (or too high).

- Set the volume of the connected component lower (or higher).
-

Optional components

There is no sound.

- Refer to General item “There is no sound.” on page 64 and check the condition of the system.
 - Connect the component properly (see pages 59 and 60) while checking:
 - if the cords/cables are connected properly.
 - if the cord/cable connectors are firmly inserted all the way.
 - Turn on the connected component.
 - Refer to the operating instructions included with the connected component and start playing.
-

The sound from the component connected to the DIGITAL OPTICAL IN jack is not heard.

- Press FUNCTION repeatedly until “OPTICAL IN” appears.
-

Tuner

Severe hum or noise/stations cannot be received.

- Set the proper band and frequency (see page 7).
 - Connect the antenna properly (see page 4).
 - Find a place and an orientation that provide good reception, then set up the antenna again. If you cannot obtain good reception, we recommend you connect a commercially available external antenna.
 - The supplied FM lead antenna receives signals along its entire length, so make sure you extend it fully.
 - Locate the antennas as far away from the speaker cords as possible.
 - Consult your nearest Sony dealer if the supplied AM antenna has come off the plastic stand.
 - Try turning off surrounding electrical equipments.
-





A stereo FM program cannot be received in stereo.

- Press STEREO/MONO until “STEREO” appears in the display.
 - See “Severe hum or noise/stations cannot be received.”, and check the antenna condition.
-

Cyclical static noise is heard while recording on an MD.

- Adjust the antenna orientation and position until the noise stops.
-

If the system still does not operate properly after performing the above measures, reset the system as follows:

With the system turned on, press MD/CD   , REC MODE and CD  at the same time.

“COLD RESET” appears, and the system turns off.

The system is reset to the factory settings. All the settings you made such as the preset stations, clock, timer and CD disc titles are cleared and must be set again.

Self-diagnosis Display

This system has a Self-diagnosis display function to let you know if there is a system malfunction. The display shows a code made up of three or five letters and a message alternately to show you the problem. To solve the problem refer to the following list. If any problem persists, consult your nearest Sony dealer.

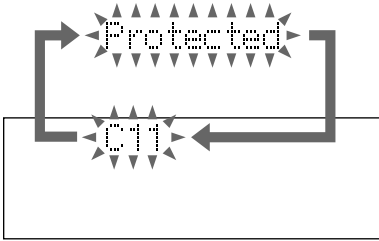

C11/Protected

The MD is protected against erasure.

- Remove the MD and slide the tab to close the slot (see page 24).

C12/Cannot Copy

You tried to record a CD or MD with a format that the system does not support, such as a CD-ROM.

- Remove the disc and turn off the system once, then turn it on again.

C13/REC Error

Recording could not be performed properly.

- Move the system to a stable place, and start recording over from the beginning.

The MD is dirty or scratched, or the MD does not meet the standards.

- Replace the MD and start recording over from the beginning.

C13/Read Error

The MD deck cannot read the disc information properly.

- Remove the MD once, then insert it again.

C14/Toc Error

The MD deck cannot read the disc information properly.

- Replace the MD.
- Erase all the recorded contents of the MD using the All Erase function on page 41.

C41/Cannot Copy

The sound source is a copy of a commercially available music software, or you tried to record a CD-R (Recordable CD).

- The Serial Copy Management System prevents making a digital copy (see page 63). You cannot record a CD-R.

C71/Check OPT-IN

This appears momentarily because of the signal of the digital broadcast during recording.

- There is no affect on the recorded contents.

No component is connected to the DIGITAL OPTICAL IN jack, or a digital component is not connected properly.

- Connect a digital component to the DIGITAL OPTICAL IN jack properly using a digital connecting cable (not supplied, see page 60).

The connected digital component is not turned on.

- See the operating instructions supplied with the connected component and confirm whether the component is turned on.

The digital connecting cable connected to the DIGITAL OPTICAL IN jack is pulled out, or the connected digital component is turned off during digital recording.

- Connect the cable, or turn on the digital component.

E0001/MEMORY NG

There is an error in the internal data that the system needs in order to operate.

- Consult your nearest Sony dealer.

E0101/LASER NG

There is a problem with the optical pickup.

- The optical pickup may have failed. Consult your nearest Sony dealer.

continued

Self-diagnosis Display (continued)

Messages

One of the following messages may appear or flash in the display during operation.

MD

Auto Cut

The MD deck is pausing the recording because silence continued for about 30 seconds or more during digital recording.

Blank Disc

The inserted recordable MD is new, or all tracks on the MD have been erased.

Cannot Edit

- A pre-mastered MD is in the deck.
- You tried to edit during Program or Shuffle Play.

Cannot REC

- A pre-mastered MD is in the deck.
- The function is switched to MD.

Complete!

The editing operation of MDs is completed.

Disc Full!

There is no time remaining on the MD.

Eject

The MD deck is ejecting the MD.

Impossible

- You tried to make an impossible editing operation.
- You cannot combine the tracks due to the system limitations of MDs.

Incomplete!

The S.F Edit (changing the recording level after recording, Fade-in, Fade-out) operation was not performed properly because the deck was moved while recording was in progress or the MD is damaged or dirty.

Initialize (flashing)

The Setup Menu settings have been lost. Or the contents recorded by the timer have disappeared over time and are not be available for saving to disc, or Program Play could not be activated since the program has disappeared over time.

(The message flashes for about four seconds when you turn on the deck by pressing I/⏪.)

Name Full!

There is no more space to store track or disc titles.

No Change

While attempting to change the recording level after recording, you pressed ENTER/YES without actually changing the recording level, so no change was made.

No Disc

There is no disc in the MD deck.

No Name

You tried to show the title of a non-labeled disc or track.

—OVER—

You have reached the end of the MD while keep pressing MD/CD ►►►► during playing pause.

Push STOP!

You pressed PLAY MODE during play.

—Rehearsal—

The MD is playing the specified dividing point for confirmation during the Divide function.

S.F Edit!

You attempted to perform another operation while in S.F Edit (changing the recording level after recording, Fade-in, Fade-out) mode.

You cannot perform any other operations while in S.F Edit mode.

S.F Edit NOW

You pressed I/⏻ while in S.F Edit (changing the recording level after recording, Fade-in, Fade-out) mode.

If you turn off the deck while in S.F Edit mode, any changes that you have made will not be made properly. Finish the changes and leave S.F Edit mode before turning off the deck. If you accidentally turn off the deck while changes are being made, press I/⏻ while the message is displayed.

Smart Space

The signal was input again after silence continued for about 3 or more but less than about 30 seconds during digital recording.

Text Protect

There is CD TEXT information which cannot be recorded on the MD.

TOC Reading

The MD deck is reading the TOC information of the MD.

TOC Writing

The MD deck is writing the information of recorded or edited contents.

Track End

You have reached the end of the track while adjusting the dividing point during the Divide Function.

CD

Check and CD Position appear alternately

The disc could not be read properly.

Complete!

CD editing (Disc Memo) finished normally.

File Full

There are already 100 disc titles stored in the system.

No Disc

There is no disc in the CD player.

—OVER—

You have reached the end of the CD while keeping pressing MD/CD ►►►► during pause.

Push STOP!

You pressed PLAY MODE during play.

Specifications

Main Unit (HCD-MD595)

Amplifier section

For the U.S. and Canadian models

AUDIO POWER SPECIFICATIONS

POWER OUTPUT AND TOTAL

HARMONIC DISTORTION:

With 6 ohm loads, both channels driven, from 120 – 10,000 Hz; rated 20 watts per channel minimum RMS power, with no more than 0.9% total harmonic distortion from 250 milliwatts to rated output.

Continuous RMS power output:

25 + 25 watts (6 ohms at 1 kHz,
10% THD, 120 V) (Reference)

European model:

DIN power output (Rated): 25 + 25 watts (6 ohms at 1 kHz,
DIN, 230 V)

Continuous RMS power output (Reference):

30 + 30 watts (6 ohms at 1 kHz,
10% THD, 230 V)

Music power output (Reference):

50 + 50 watts

Other models:

DIN power output (Rated): 20 + 20 watts (6 ohms at 1 kHz,
DIN, 240 V)

18 + 18 watts (6 ohms at 1 kHz,
DIN, 220 V)

Continuous RMS power output (Reference):

25 + 25 watts (6 ohms at 1 kHz,
10% THD, 240 V)
23 + 23 watts (6 ohms at 1 kHz,
10% THD, 220 V)

Peak Music Power Output: 400 watts

Inputs

TAPE IN (phono jacks): voltage 250 mV, impedance
47 kilohms

DIGITAL OPTICAL IN (Supported sampling frequencies:
32 kHz, 44.1 kHz and 48 kHz)

ANALOG IN (stereo minijack):

voltage 250 mV, impedance
47 kilohms

Outputs

TAPE OUT (phono jacks): voltage 250 mV, impedance
1 kilohm

PHONES (stereo minijack):

accepts headphones of 8 ohms or
more.

SPEAKER:

accepts impedance of 6 to 16
ohms.

CD player section

System	Compact disc and digital audio system
Laser	Semiconductor laser ($\lambda=800$ nm) Emission duration: continuous
Laser output	Max. 44.6 μ W* * This output is the value measured at a distance of 200 mm from the objective lens surface on the Optical Pick-up Block with a 7 mm aperture.
Frequency response	2 Hz – 20 kHz

MD deck section

System	MiniDisc digital audio system
Laser	Semiconductor laser ($\lambda=780$ nm) Emission duration: continuous
Laser output	Max. 44.6 μ W* * This output is the value measured at a distance of 200 mm from the objective lens surface on the Optical Pick-up Block with a 7 mm aperture.
Sampling frequency	44.1 kHz
Frequency response	5 Hz – 20 kHz

Tuner section

FM stereo, FM/AM superheterodyne tuner

FM tuner section

Tuning range	
Tourist model:	76.0 – 108.0 MHz (50 kHz step)
European model:	87.5 – 108.0 MHz (50 kHz step)
Other models:	87.5 – 108.0 MHz (100 kHz step)

Antenna	FM lead antenna
Antenna terminals	75 ohms unbalanced
Intermediate frequency	10.7 MHz

AM tuner section

Tuning range	
European model:	531 – 1,602 kHz (with the interval set at 9 kHz)
Other models:	531 – 1,602 kHz (with the interval set at 9 kHz) 530 – 1,710 kHz (with the interval set at 10 kHz)
Antenna	AM loop antenna External antenna terminals
Intermediate frequency	450 kHz

Speaker (SS-CMD595)

Speaker system	2-way, bass-reflex type
Speaker units	
Woofer:	12 cm dia., cone type
Tweeter:	2.8 cm dia., balanced drive type
Nominal impedance	6 ohms

General

Power requirements

U.S.A. and Canadian models:

120 V AC, 60 Hz

Australian model: 220 – 240 V AC, 50/60 Hz

Chinese model: 220 V AC, 50/60 Hz

European model: 230 V AC, 50/60 Hz

Other models: 110 – 120 V or 220 – 240 V AC, 50/60 Hz

Power consumption

U.S.A. and Canadian models:

60 watts during normal operation

Other models: 70 watts during normal operation

Dimensions (w/h/d) incl. projecting parts and controls

Amplifier/Tuner/MD/CD section:

Approx. 215 × 147 × 326 mm

Speaker: Approx. 160 × 260 × 235 mm

Mass

Amplifier/Tuner/MD/CD section:

Approx. 5.0 kg

Speakers: Approx. 2.7 kg net per speaker

Supplied accessories

R6 (size AA) batteries (2)

AM loop antenna (1)

FM lead antenna (1)

Speaker cords (2)

Design and specifications are subject to change without notice.

Parts descriptions for the remote

You can use the supplied remote to control the system.

Note

You cannot perform the following operations with the remote;

- Removing discs
- Selecting the recording mode
- CD-MD Synchro Recording

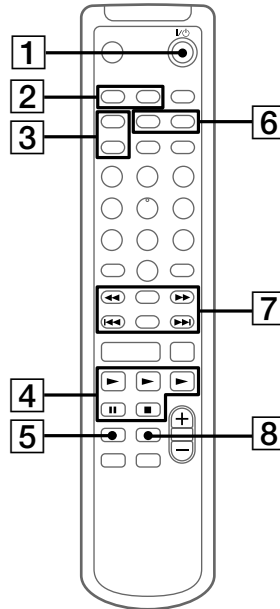

1 I/O (power) switch

2 CLOCK/TIMER SELECT button

Press to check timer settings, or to set the timer on/off. (pages 56, 58)

CLOCK/TIMER SET button

Press to set the clock and timer functions. (pages 6, 55, 57)

continued

Parts descriptions for the remote (continued)

3 **DISPLAY button**

Press to switch the contents appearing on the upper level of the display (preset equalizer name, clock, disc name/track name/radio station name, volume, etc.). (pages 9, 17, 23)

TIME button

Press to switch the contents appearing on the lower level of the display (CD/MD play time mode, etc.). (pages 9, 17, 23)

4 **▶ (play) button**

|| (pause) button

■ (stop) button

5 **MD ● REC button**

6 **PLAY MODE/TUNING MODE button**

This functions as the PLAY MODE button when playing a CD or MD. Press to select normal play, Shuffle Play or Program Play.

This functions as the TUNING MODE button when listening to the radio. Press to select MANUAL, AUTO or PRESET tuning. (pages 15, 16, 21)

REPEAT button

Press to play a track or all the tracks repeatedly. (pages 15, 20)

7 **CURSOR ←/→, ◀▶ buttons**

Press to skip to the beginning of the next track or the previous track when playing a CD or MD.

Press to tune the frequency when listening to the radio.

These buttons are also used to set the clock, make the Program Play setting, adjust the recording level, and select characters to be entered, etc.

+/-, ◀▶ (AMS: Automatic Music Sensor) buttons

ENTER/YES button

Press to set the clock, Program Play and to label a CD, MD and preset station, or to enter the settings in “Edit Menu” or “Setup Menu”.

MENU/NO button

Press to label a CD, MD and preset station.

8 **TIME MACHINE REC button**

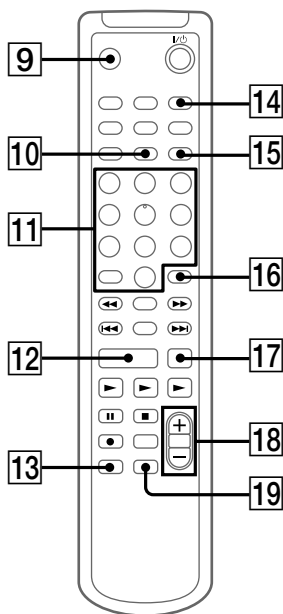

9 SLEEP button

Press to set Sleep Timer. (page 55)

10 NAME EDIT/SELECT button

Press to display the text input screen and to select the type of characters to be input. (pages 18, 38, 53)

11 Letter/Number buttons

Press to select track numbers of a CD, MD, or preset station.

Press to enter the corresponding letter or number at the character input screen.

12 FUNCTION button

Press to switch the sound source.

Each time you press this button, the sound source changes as follows;

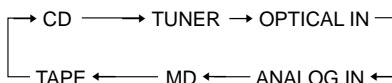

13 PRESET EQ button

Press to select the type of the preset equalizer. (page 52)

14 STEREO/MONO button

Press to switch between stereo and monaural when receiving a stereo broadcast, etc.

15 SCROLL button

Press to display the disc title or track title scrolling. (pages 18, 19, 23, 40)

16 CLEAR button

Press to cancel the selection. (pages 16, 19, 22, 39, 54)

17 TUNER/BAND button

Press to select the tuner for the sound source, or to select the FM or AM band.

18 VOLUME +/- buttons

Press to adjust the volume.

19 DBFB button

Press to reinforce the bass sound. (page 52)

Index

A

- A-B Erase Function 42
- Adjusting
 - the operating voltage 5
 - the recording level 36, 49
 - the sound 52
 - the volume 9, 12, 13
- After
 - editing 37
 - recording 24
- All Erase Function 41
- Analogue recording 24
- Auto Cut 34
- Automatic Source Selection 9, 12, 13
- Automatic tuning 13

B

- Batteries 5
- Before
 - editing 37
 - recording 24

C

- CD-MD Synchro Recording 10, 25
- CD TEXT information 18
- Clock setting 6
- Combine Function 46
- Connecting. *See* Hooking up

D

- Daily Timer 55
- DBFB 52
- Digital recording 24
- Disc Memo 18
- Display 17, 23
- Divide Function 45

E

- Erase Function 40
- Erasing
 - a portion of a track 42
 - a single track 40
 - a track number 46
 - all tracks on an MD 41

F, G

- Fade-in 50
- Fade-out 50

H, I, J, K

- High-Speed CD-MD Synchro Recording 26
- Hooking up
 - optional components 59
 - the antennas 4
 - the power 5
 - the speakers 4

L

- Labeling
 - a CD 18
 - a preset station 53
 - an MD 38
- Level Synchro Recording 32
- Listening to the radio 12

M

- Manual tuning 13
- Messages 67
- Move Function 43

N

- Name Function 38
- Normal Play 9, 11

O

- Optional equipments 59

P, Q

- Playing
 - a CD 9, 15
 - an MD 11, 20
 - tracks in random order (Shuffle Play) 15, 21
 - tracks in the desired order (Program Play) 16, 21
 - tracks repeatedly (Repeat Play) 15, 20
- Power Saving Mode 7
- Preset Equalizer menu 52
- Preset Tuning 12
- Presetting radio stations 7
- Program Play 16, 21
- Protecting recordings 24

R

- Radio stations
 - presetting 7
 - tuning in 13
- RDS 54
- Recording
 - a CD 10, 25
 - a radio program 13
 - long time recording 28
 - manual recording 30
 - monaural recording 28
 - on an MD 10, 24
 - timer recording 57
- Repeat Play 15, 20
- Resetting the system 66

S

- Saving recordings 24
- Self-diagnosis display 67
- Serial copy management system
63
- Setting the time 6
- S.F Edit Function 49
- Showing the time 7
- Shuffle Play 15, 21
- Sleep Timer 55
- Smart Space 34
- Sound adjustment 52
- Speakers 4
- Station Name 53
- System limitations 62

T

- Time Machine Recording 31
- Timer
 - falling asleep to music 55
 - timer recording 57
 - waking up to music 55
- Track marking 32, 45
- Track numbers 32, 45
- Troubleshooting 64
- Tuning interval 8

U, V, W, X, Y, Z

- Undo Function 48

