



SONY[®]

4-232-651-13 (1)

Mini Hi-Fi Component System

Operating Instructions



***MHC-VX777
MHC-VX555/VX555J***

© 2001 Sony Corporation





WARNING

To prevent fire or shock hazard, do not expose the unit to rain or moisture.

To avoid electrical shock, do not open the cabinet. Refer servicing to qualified personnel only.

Do not install the appliance in a confined space, such as a bookcase or built-in cabinet.

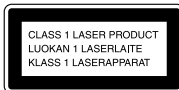

This appliance is classified as a CLASS 1 LASER product. The CLASS 1 LASER PRODUCT MARKING is located on the rear exterior.



This stereo system is equipped with the Dolby B-type noise reduction system*. (MHC-VX777 only).

* Manufactured under license from Dolby Laboratories Licensing Corporation. DOLBY and the double-D symbol  are trademarks of Dolby Laboratories Licensing Corporation.



Don't throw a battery, dispose it as the injurious wastes.

This system can play the following discs

	VIDEO CDs	Audio CDs
Disc logo		
Contents	Audio + Video (moving pictures)	Audio
Disc size	12 cm/8 cm	12 cm/8 cm
Play time	74 min./20 min.	74 min./20 min.

Note on VIDEO CDs

This system conforms to VIDEO CDs without PBC* functions (Ver. 1.1) and VIDEO CDs with PBC functions (Ver. 2.0) of VIDEO CD standards. You can enjoy two kinds of playback according to the disc type.

Disc type	You can
VIDEO CDs without PBC functions (Ver. 1.1 discs)	Enjoy video playback (moving pictures) as well as audio CDs.
VIDEO CDs with PBC functions (Ver. 2.0 discs)	Play interactive software using menu screens displayed on the TV screen (menu playback), in addition to the video playback function of VIDEO CDs without PBC functions. Moreover, you can play high or standard quality still picture.

* PBC = Play Back Control

About this manual

The instructions in this manual are for MHC-VX777 and VX555/VX555J. MHC-VX777 is the model used for illustration purposes only. The location of some buttons on MHC-VX555/VX555J is different, but the name of the buttons is the same.



Table of Contents

Parts Identification

Main unit	4
Remote Control	5

Getting Started

Hooking up the system	6
Inserting the batteries into the remote control	8
Setting the time	8
Saving the power in standby mode	9

VIDEO CD/CD

Loading the VIDEO CD/CD	10
Playing the VIDEO CD	
— Normal Play/Shuffle Play/Repeat Play	10
Playing a VIDEO CD with PBC functions (Ver. 2.0)	
— PBC Play	11
Playing a CD	
— Normal Play/Shuffle Play/Repeat Play	12
Programming the VIDEO CD/CD tracks	
— Program Play	13
Using the VIDEO CD/CD display	14
Using the on-screen display	14
Locating a specific part of a disc	15
Resuming playback from the point you stopped a VIDEO CD	
— Resume Play	16
Adjusting the picture	
— Picture Effect	16

Tuner

Presetting radio stations	17
Listening to the radio	
— Preset Tuning	18

Tape

Loading a tape	19
Playing a tape	19
Recording to a tape	
— CD Synchro Recording/High Speed Dubbing/Recording Manually/Program Edit	20
Timer-recording radio programs	21

Sound Adjustment

Adjusting the sound	23
Selecting the sound system	23
Selecting the audio emphasis effect	23
Adjusting the graphic equalizer	24
Selecting the surround effect	24
Making a personal audio emphasis file	
— Personal file	24

Other features

Changing the spectrum analyzer display	25
Singing along: Karaoke	25
Mixing and recording sounds	26
Falling asleep to music	
— Sleep Timer	26
Waking up to music	
— Daily Timer	27

Optional components

Connecting MD deck/VCR	28
Connecting a Video Game Player	28
Connecting external antennas	29

Additional Information

Precautions	30
Troubleshooting	31
Specifications	33
Glossary	35

Parts Identification

Main unit

The items are arranged in alphabetical order. Refer to the pages indicated in parentheses () for details.

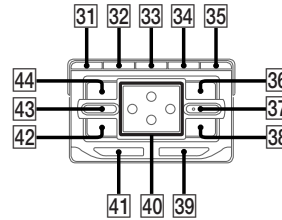
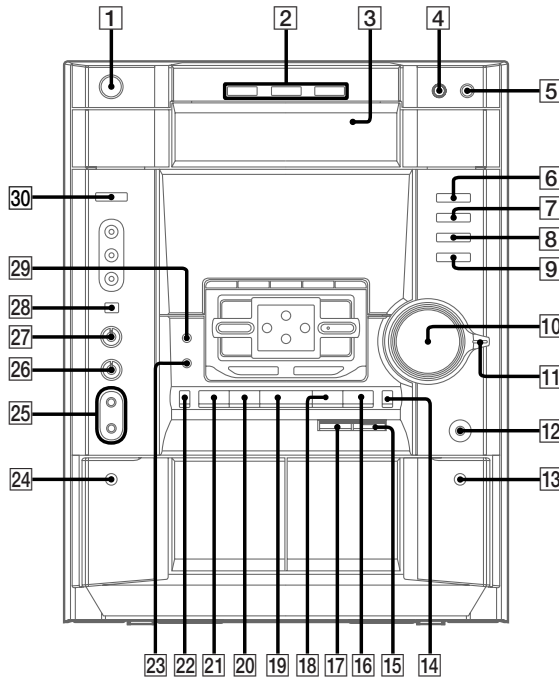

SHUTTLE **11** (11, 12)
SPECTRUM **32** (25)
SURROUND SPEAKER MODE
(MHC-VX777 only) **28** (23)

TAPE A/B **8** (19, 20, 26)
TUNER/BAND **7** (17, 18)
TUNER MEMORY **35** (17)

VOLUME control **10** (25, 27)
: Adjusts the volume.

CD **6** (8, 10~12, 20, 21)
CD SYNC HI-DUB **17** (20, 21)
CINEMA SPACE **39** (24)

GAME **30** (29)
GAME EQ **42** (7, 23, 29)
GROOVE **41** (23)

DECK A **▲** **24** (19, 20)
DECK B **▲** **13** (19, 20)
DIRECTION **33** (19~21, 26)
DISC 1~3 **2** (10, 11, 12, 13, 21)
DISC SKIP EX-CHANGE **4**
(10~13, 16)
Disc tray **3** (10)
DISPLAY **31** (9, 14, 31)
DOLBY NR (MHC-VX777 only)
34 (19~21)

KARAOKE PON **29** (25)
MD (VIDEO) **9** (28, 31)
MIC 1/2 **25** (25)
MIC LEVEL **26** (25)
MOVIE EQ **36** (7, 23, 29)
MUSIC EQ **44** (7, 23, 29)

ECHO LEVEL **27** (25)
EDIT **33** (21)
EFFECT ON/OFF **43** (23, 25)
ENTER **37** (8, 11~13, 16, 17, 21,
22, 24, 32)

P FILE **38** (24)
PICTURE EFFECT **23** (16)
PHONES jack **12**
: Connect the headphones
PLAY MODE **35** (10, 12, 13, 21,
32)

REC PAUSE/START **15** (20, 21,
26)
REPEAT **34** (11, 13)

FM MODE **34** (18, 32)

BUTTON DESCRIPTIONS

I/⏻ (power) **1** (7, 8, 9, 18, 28,
31, 32)
▲ OPEN/CLOSE (disc tray)
5 (10, 11, 13)
■ (stop) **20** (10~12, 15, 16, 19,
20, 26, 32)
▶▶ (play) **19** (10~13, 15, 16,
20, 26, 35)
▶▶▶ (go forward) **16** (10~13,
15~21)
|| (pause) **18** (10, 12, 19, 20)
◀◀ (go back) **21** (10~13, 15~21)
◀◀◀ (rewind) **22** (11, 12,
17~19, 32)
▶▶▶ (fast forward) **14** (11, 12,
17~19)
▲/▼/◀/▶ (cursor) **40** (8, 16, 21,
22, 24, 27)

4



Remote Control

The items are arranged in alphabetical order. Refer to the pages indicated in parentheses () for details.

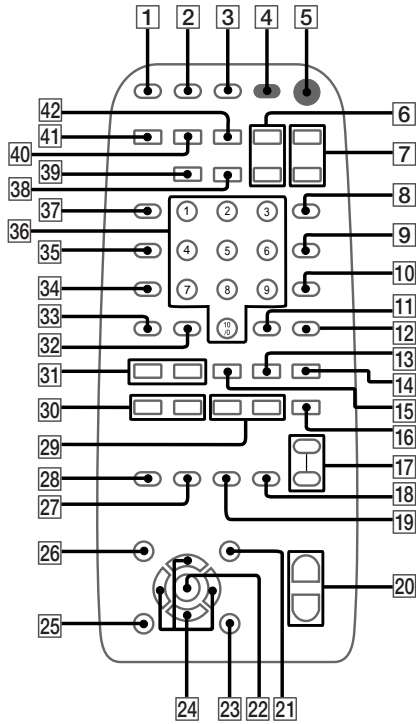

- CD **41** (10~12, 20, 21)
- CINEMA SPACE **19** (24)
- CLEAR **33** (13, 15)
- CLOCK/TIMER SELECT **2** (22, 27)
- CLOCK/TIMER SET **3** (8, 21, 27)
- D.SKIP **12** (10~13, 16)
- DISPLAY **37** (9, 14, 31)
- EFFECT ON/OFF **18** (23, 25)
- ENTER **22** (8, 11~13, 16, 17, 21, 22, 24, 32)
- GAME **39** (29)
- GAME EQ **25** (7, 23, 29)
- KARAOKE PON **34** (25)
- KEY CONTROL **17** (25)
- MD (VIDEO) **38** (28, 31)

- MOVIE EQ **21** (7, 23, 29)
- MUSIC EQ **26** (7, 23, 29)
- NEXT **31** (11, 15, 16)
- Numeric buttons **36** (11, 12, 15)
- ON SCREEN **11** (14)
- PREV **31** (11, 12, 15, 16)
- PICTURE EFFECT **27** (16)
- P FILE **23** (24)
- REPEAT **9** (11, 13)
- RETURN **15** (11)
- SLEEP **1** (26)
- SURROUND SPEAKER MODE (MHC-VX777 only) **28** (23)
- SPECIAL MENU **10** (14~16)
- SPECTRUM **35** (25)
- SELECT **13** (11)

- TAPE A/B **42** (19, 20, 26)
- TUNER/BAND **40** (17, 18)
- TV I/⏻ **4** (8)
- TV VIDEO **8** (8)
- TV VOL +/- **6** (8)
- TV CH +/- **7** (8)

VOL +/- **20** (25, 27)
: Adjusts the volume.

BUTTON DESCRIPTIONS

- I/⏻ (power) **5** (7, 8, 9, 18, 28, 31, 32)
- ◀▶ (play) **13** (10~13, 15, 16, 20, 26, 35)
- ⏸ (pause) **14** (10, 12, 19)
- (stop) **16** (10~12, 15, 16, 19, 20, 26, 32)
- ◀◀ (go back)/PRESET - **30** (10~13, 15~21)
- ▶▶ (go forward)/PRESET + **30** (10~13, 15~21)
- ◀◀ (rewind)/TUNING - **29** (11, 12, 17~19, 32)
- ▶▶ (fast forward)/TUNING + **29** (11, 12, 17~19)
- ▲▼/◀▶ (cursor) **24** (8, 16, 21, 24, 27)



Getting Started

Hooking up the system

Do the following procedure **1** to **7** to hook up your system using the supplied cords and accessories.

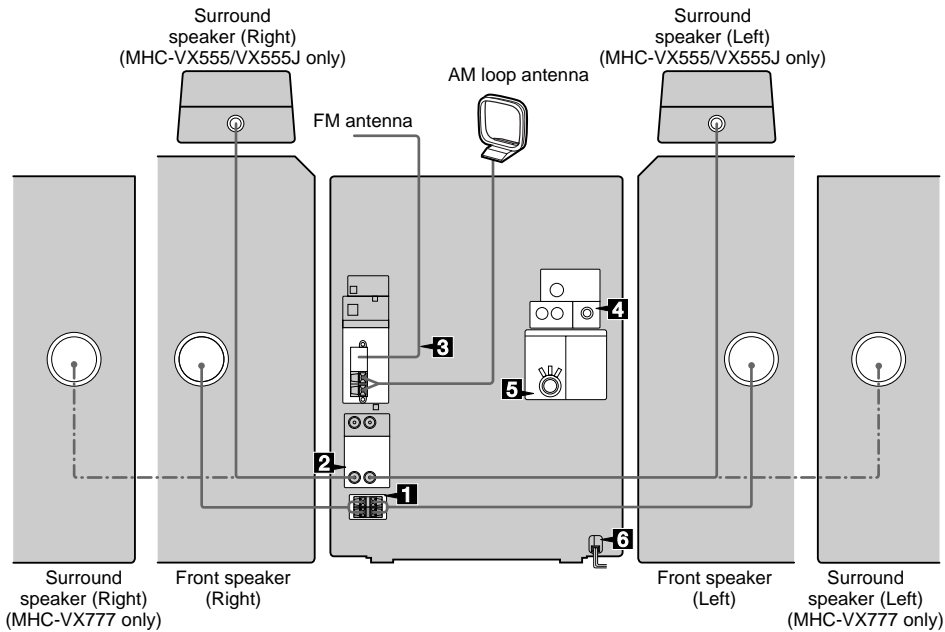

1 Connect the speakers.

Connect the speaker cords of front speakers to the SPEAKER jacks as below.

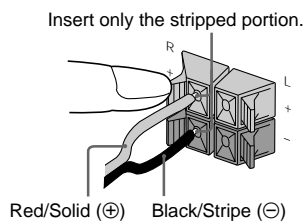

2 Connect the surround speaker.

Connect the speaker cords to SURROUND SPEAKER jacks.

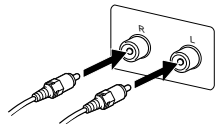

Note

Keep the speaker cords away from the antennas to prevent noise.

6

3 Connect the FM/AM antennas.

Set up the AM loop antenna, then connect it.

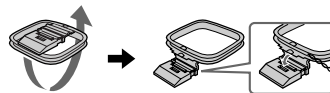

Jack type **A**
AM loop antenna Extend the FM lead antenna horizontally.

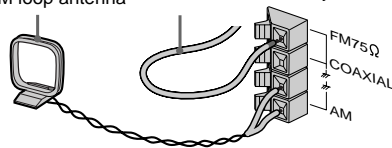

Jack type **B**
AM loop antenna Extend the FM lead antenna horizontally.

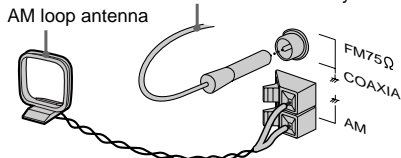



4 Connect the video input jack of your TV to the VIDEO OUT jack using the supplied cable.

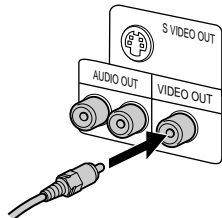

Tip

For even higher quality video images, you can use an optional S. Video cable to connect the S. VIDEO input jack on your TV to the S. VIDEO OUT jack. S. VIDEO is available for Video CD output only.

5 For models with a voltage selector, set **VOLTAGE SELECTOR** to the position of your local power line voltage.

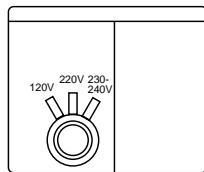

6 Connect the power cord to a wall outlet.

The demonstration appears in the display. When you press I/⏻, the system turns on and the demonstration automatically ends. If the supplied adaptor on the plug does not fit your wall outlet, detach it from the plug (only for models equipped with the adaptor).

7 Set the color system according to your TV while the power is off.

The color system of your TV	Do this
NTSC	Press I/⏻ while holding down GAME EQ. The color system is set to NTSC.
PAL	Press I/⏻ while holding down MUSIC EQ. The color system is set to PAL.
AUTO*	Press I/⏻ while holding down MOVIE EQ. The color system is set to AUTO.

* When your TV automatically changes the color system according to the input signal.

Tip

Color system is available for Video CD output only.

To attach the front speaker pads Attach the supplied front speaker pads to the bottom of the speakers to stabilize the speakers and prevent them from slipping.

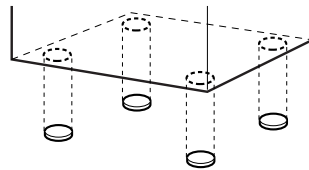

Positioning the speakers

Place the front speakers at an angle of 45 degrees from your listening position.

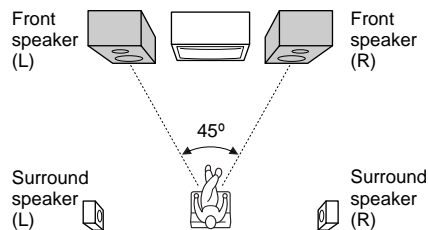

continued

Getting Started

Hooking up the system (continued)

When carrying this system
Do the following to protect the CD mechanism.

- 1 Make sure that all discs are removed from the unit.
- 2 Hold down CD and then press I/⏻ until "LOCK" appears.
- 3 Release I/⏻ first, then release CD.
- 4 Unplug the AC power cord.

Inserting the batteries into the remote control

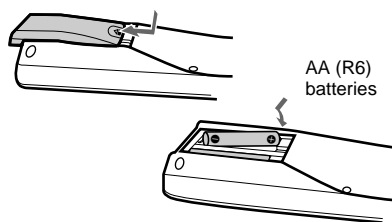

Using the remote

To	Press
Turn the TV on or off	TV I/⏻.
Switch the TV's video input	TV/VIDEO
Change the TV Channel	TV CH +/-
Adjust the volume of the TV speaker	TV VOL +/-

Tip

When the remote no longer operates the system, replace both batteries with new ones.

Note

If you do not use the remote for a long period of time, remove the batteries to avoid possible damage from battery leakage.

Setting the time

- 1 Turn on the system.
- 2 Press **CLOCK/TIMER SET** on the remote.
When you set the time for the first time, proceed to step 5.
- 3 Press cursor ▼/▲ repeatedly to select **CLOCK SET**.
- 4 Press **ENTER**.
- 5 Press cursor ▼/▲ repeatedly to set the hour.
- 6 Press **ENTER**.
- 7 Press cursor ▼/▲ repeatedly to set the minute.

- 8 Press **ENTER**.

The clock starts working.

Tip

If you have made a mistake or want to change the time, start over from step 2.

Note

The clock settings are canceled when you disconnect the power cord or if a power failure occurs.



Saving the power in standby mode

Press DISPLAY repeatedly when the power is off.

Each time you press the button, the system switches cyclically as follows:

Demonstration → Clock → Power Saving Mode

Tips

- The I/⏻ indicator light up even in the Power Saving Mode.
- The timer works in the Power Saving Mode.

Note

You cannot set the time in the Power Saving Mode.

To cancel the Power Saving Mode

Press DISPLAY once to show the demonstration, twice to show the clock display.

Getting Started



VIDEO CD/CD

Loading the VIDEO CD/CD

- 1 Press **▲ OPEN/CLOSE**.
The CD compartment slides out.
- 2 Place a **VIDEO CD/CD** with the label side up on the disc tray.

When you play a VIDEO CD/CD single, place it on the inner circle of the tray.

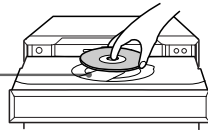

To insert additional discs, press **DISC SKIP EX-CHANGE** to rotate the disc tray.

- 3 Press **▲ OPEN/CLOSE** to close the CD compartment.

Playing the VIDEO CD

—Normal Play/Shuffle Play/Repeat Play

You can play both VIDEO CDs without PBC functions (Ver. 1.1) and VIDEO CDs with PBC functions (Ver. 2.0).

This unit lets you play the VIDEO CD in different play modes.

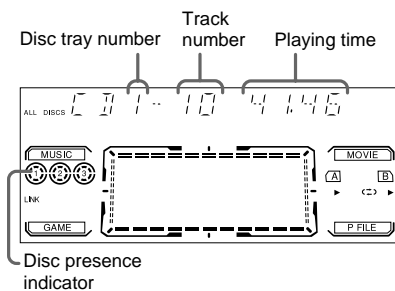

- 1 Turn on your TV and select the video input.
Refer to the operating instructions supplied with your TV if you need help.



- 2 Press **PLAY MODE** repeatedly until the mode you want appears in the display.

Select	To play
ALL DISCS	All VIDEO CDs in the disc tray continuously.
1 DISC	The VIDEO CDs you have selected in the original order.
SHUFFLE ALL DISCS	The tracks on all VIDEO CDs in random order.
SHUFFLE 1 DISC	The tracks on the VIDEO CD you have selected in random order.
PROGRAM	The tracks on all VIDEO CDs in the order you want (see "Programming the VIDEO CD tracks").

- 3 Press one of the **DISC 1-3** buttons.

If you press **◀▶** when CD is selected as the function (press CD) and the disc tray is closed, play starts from the VIDEO CD loaded on tray whose disc tray number appears in the display.

Tip

You cannot change the play mode during playback.

Other Operations

To	Do this
Stop playback	Press ■ .
Pause	Press ⏸ *1. Press again to resume play.
Select a track or scene*2	Press ▶▶ to go forward, ◀◀ to go back. When you play VIDEO CDs with PBC functions (Ver 2.0), see page 11.



To	Do this
Find a point in a track or scene	There are two types of searching: ① (Manual Search) Turn SHUTTLE clockwise (to go forward) or counter clockwise (to go back) until it clicks during playback and hold. Release SHUTTLE when you reach the desired point. ② (Lock Search function) Press ►► or ◀◀ during playback. Each time you press the button, speed changes as follows: 1 (slow) → 2 (normal) → 3 (high) → 1 (slow) ... Press ◀◀ to stop searching and start playback at the desired point.
Select a VIDEO CD in stop mode	Press one of the DISC 1~3 buttons or DISC SKIP EX-CHANGE (or D. SKIP on the remote).
Switch to CD function from another source	Press CD or DISC 1~3 (Automatic Source Selection).
Remove the VIDEO CD	Press ▲ OPEN/CLOSE.
Exchange other VIDEO CDs while playing	Press DISC SKIP EX-CHANGE.
Play repeatedly (Repeat Play)	Press REPEAT repeatedly to select "REPEAT"* ³ or "REPEAT 1"* ^{2*4} .
Cancel Repeat play	Press REPEAT until "REPEAT" or "REPEAT 1" disappears from the display.

^{*1} There may be some disturbance in the VIDEO Image.

^{*2} Only when PBC function is set to off or when playing VIDEO CDs without PBC functions. (Version 1.1)

^{*3} All the tracks repeated up to five times. You cannot use this function during SHUFFLE ALL DISCS.

^{*4} To repeat the current track you are playing.

Tip

Pressing the CD while the power is off automatically turns the power on and CD is selected as a function. When the system is in the power saving mode, this function does not work.

Playing a VIDEO CD with PBC functions (Ver. 2.0)

— PBC Play

You can use menus on your TV screen to enjoy the disc's interactive software. The menu format and structure may differ with each disc.

1 Press CD.

2 Press ◀◀ to start playing a VIDEO CD with PBC functions (Ver. 2.0).

The VIDEO CD and PBC indicators light up and a PBC menu appears on your TV.

- Video CD : Indicator lights during playback of a VIDEO CD.
- PBC : Indicator lights during PBC playback of a PBC compatible VIDEO CD (Ver. 2.0).
- PBC OFF : Indicator lights when a PBC compatible VIDEO CD (Ver. 2.0) is played without using the PBC functions.

3 Press I◀◀ or ►► repeatedly to select a number from the menu, then press ENTER/SELECT (press the numeric button on the remote).

4 Continue according to the instructions on the menus to enjoy interactive playback.

To	Do this
Stop play	Press ■.
Go to the next menu page or scene	Press NEXT on the remote.
Go back to the previous menu page or scene	Press PREV on the remote.
Go back to the previous menu	Press RETURN ↶ on the remote.

continued

VIDEO CD/CD

Playing a VIDEO CD with PBC functions (Ver. 2.0) (continued)

To	Do this
Cancel playback with PBC function (Ver 2.0)	Press ◀◀ or ▶▶ repeatedly in the stop mode to select the track you want, then press ENTER (or press numeric button on the remote). The PBC OFF indicator lights up and playback begins from selected track. Still images, which is as the menu screen will not be shown.
Select a menu number using the remote	Press numeric button in the order you want. To enter 11 or over, first press > 10, then press numeric buttons. To enter 0, use the 10/0.

Tips

- When  appears on the TV screen, you have pressed an invalid button. Press a button indicated by the instructions on the menu screen.
- When you press NEXT on the remote during menu playback or while playing moving pictures, the next scene on the disc appears. Also refer to the instructions supplied with the disc.

Playing a CD

—Normal Play/Shuffle Play/Repeat Play

This unit lets you play the CD in different play modes.

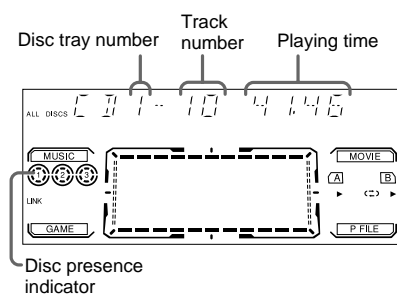

1 Press PLAY MODE repeatedly until the mode you want appears in the display.

Select	To play
ALL DISCS	All CDs in the disc tray continuously.
1 DISC	The CDs you have selected in the original order.
SHUFFLE ALL DISCS	The tracks on all CDs in random order.
SHUFFLE 1 DISC	The tracks on the CD you have selected in random order.
PROGRAM	The tracks on all CDs in the order you want (see "Programming the CD tracks").

2 Press one of the DISC 1-3 buttons.

If you press ◀▶ when CD is selected as the function (press CD) and the disc tray is closed, play starts from the CD loaded on tray whose disc tray number appears in the display.

Tip

You cannot change the play mode during playback.

Other Operations

To	Do this
Stop playback	Press ■.
Pause	Press ■■. Press again to resume play.
Select a track	During play or pause, press ▶▶ (to go forward) or ◀◀ (to go back).
Find a point in a track	There are two types of searching: ① (Manual Search) Turn SHUTTLE clockwise (to go forward) or counter clockwise (to go back) until it clicks during playback and hold. Release SHUTTLE when you reach the desired point. ② (Lock Search function) Press ▶▶ or ◀◀. Press ◀▶ to stop searching and start playback at the desired point.
Select a CD in stop mode	Press one of the DISC 1-3 buttons or DISC SKIP EXCHANGE (or D. SKIP on the remote).



To	Do this
Switch to CD function from another source	Press CD or DISC 1~3 (Automatic Source Selection).
Play repeatedly (Repeat Play)	Press REPEAT repeatedly to select "REPEAT"* ¹ or "REPEAT 1"* ² .
Cancel Repeat play	Press REPEAT until "REPEAT" or "REPEAT 1" disappears from the display.
Exchange other CDs while playing	Press DISC SKIP EX-CHANGE.
Remove the CD	Press ▲ OPEN/CLOSE.

*¹ All the tracks repeated up to five times.
You cannot use this function during SHUFFLE ALL DISCS.

*² To repeat the current track you are playing.

Tip

Pressing the CD while the power is off automatically turns the power on and CD is selected as a function. When the system is in the power saving mode, this function does not work.

Programming the VIDEO CD/CD tracks

— Program Play

You can make a program of up to 25 tracks from all the VIDEO CD/CDs in the order you want them to be played.

- 1 Load a VIDEO CD/CD.
- 2 Press PLAY MODE repeatedly until "PROGRAM" appears in the display.
- 3 Press one of the DISC 1~3 buttons to select a VIDEO CD/CD.

To program all the tracks on a CD at once, proceed to step 5 while "AL" appears on the display.

- 4 Press ◀◀ or ▶▶ repeatedly until the track you want appears in the display.

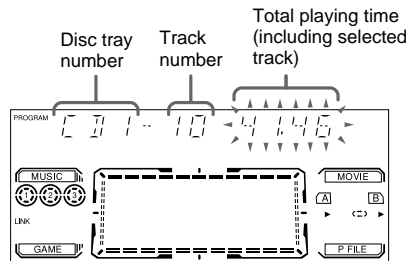

VIDEO CD/CD

- 5 Press ENTER.
The track(s) is (are) programmed. The program step number appears, followed by the total playing time.
- 6 To program additional tracks, repeat steps 3 to 5.
Skip step 3 to select tracks from the same disc.

- 7 Press ◀▶.

To	Press
Cancel Program Play	PLAY MODE repeatedly until "PROGRAM" or "SHUFFLE" disappears from the display.
Clear a track from the end	CLEAR on the remote in stop mode.
Add a track to the program in stop mode	1 Select the disc tray with DISC 1~3 button. 2 Select the track by pressing ◀◀ or ▶▶. 3 Press ENTER.

Tips

- The program you made remains in the CD player even after it has been played back. Press ◀▶ to play the same program again.
- If "--.--" appears instead of the total playing time during programming, this means:
 - you have programmed a track number which exceeds 20.
 - the total playing time has exceeded 100 minutes.



Using the VIDEO CD/CD display

You can check the remaining time of the current track or that of the VIDEO CD/CD.

When a CD TEXT disc is loaded, you can check the information stored on the disc, such as the titles or artist names. When the unit detects CD TEXT discs, the "CD-TEXT" indication appears in the display.

Press DISPLAY.

Each time you press the button, the display changes cyclically as follows:

During normal playback
 Playing time on the current track →
 Remaining time on the current track →
 Remaining time on current CD (1 DISC mode) or "--:--" display (ALL DISCS mode) → Title name of the current track*¹ → Clock display (for eight seconds) → Effect status

(VIDEO CDs with PBC functions (Ver 2.0)):
 Playing time on the current track*² → clock display (for eight seconds) → Effect status

In the stop mode

When the CD player is in program mode and there is a program:

The last track number of the program and the total playing time → Total number of programmed track (for eight seconds) → Title name and the artist name of the CD*¹ → Clock display (for eight seconds) → Effect status

In other conditions:

Total number of tracks and total playing time → Title name and the artist name of the CD*¹ → Clock display (for eight seconds) → Effect status

*¹ With CD TEXT disc only (certain characters cannot be displayed). Depending on the disc, some CD TEXT information may not appear.

*² May not appear with still images, etc.

Using the on-screen display

You can check the current operating status and disc information of VIDEO CDs or audio CDs during playback or in stop mode.

Press ON SCREEN or press SPECIAL MENU and select 4 on the remote.

Each time you press this button, the on-screen display changes as follow:

ON SCREEN ON → ON SCREEN OFF

ON SCREEN display

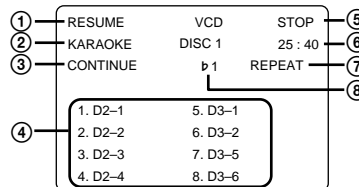

① VIDEO CD/CD status	Displayed item
In stop mode	"RESUME" or no display
During playback	Current disc and track number.

- ② KARAOKE effect status
- ③ Play mode or "AUTO PBC"*
* "AUTO PBC" appears for a VIDEO CD with PBC functions.

④ VIDEO CD/CD status	Displayed item
In program mode	Programmed disc and track numbers.
Other conditions	No display.

⑤ VIDEO CD/CD status	Displayed item
In the stop mode	"STOP".
During playback	Elapsed time of the current track.*

* AUDIO CD only.





- ⑥ Total playing time of the current disc*
* In program mode, total playing time of the program appears.
- ⑦ “REPEAT”, “REPEAT 1” or no display
- ⑧ Key control level or no display

Tip
Depending on the condition, some items are displayed and others are not.

To switch language of on-screen display (Chinese model only)
You can switch the messages in the on-screen display from Chinese to English.

- 1 Press SPECIAL MENU.
- 2 Press 5.
The messages switch from Chinese to English.
To switch back to Chinese messages, repeat the above operation.

Locating a specific part of a disc

Before using, make sure to turn on your TV screen.
These function cannot be used during playback of VIDEO CDs with PBC functions (Ver. 2.0).
Use the remote for the operation.
To use special menu with VIDEO CDs with PBC functions (Ver. 2.0)
Cancel the PBC function (see “Cancel PBC playback with PBC function” on page 12).

To enter the time or track number with the remote
Press the numeric buttons (see “To enter track number 11 or over” on page 12).
To stop playback
Press ■.

Locating by elapsed time

— Time Search

- 1 Press SPECIAL MENU.
- 2 Press 1 to select “1) TIME SEARCH.”
- 3 Press the numeric buttons (1 – 10/0) to enter the time (in minutes) for the section you want.
The selected elapsed time appears on the TV screen.
To reenter the time: Press CLEAR, and then press numeric buttons again.
- 4 Press ◀▶.
Playback starts from the selected time.



VIDEO CD/CD

Locating the track you want

— Disc Digest

You can select the track you want by viewing the first frame of each track. Nine different tracks can be displayed on the TV screen at one time.

- 1 Press SPECIAL MENU.
- 2 Press 2 to select “2) DISC DIGEST.”
The first frame of tracks 1 through 9 on the current disc are displayed.
The sound of the first three seconds of each track on an audio CD plays, but there is no sound when using a VIDEO CD.
- 3 Press the numeric buttons (1 – 9) to select the track you want.

To display the next 9 tracks
Press NEXT or ▶▶. The first frame of tracks 10 through 18 are displayed.
When there are more tracks in the disc, “▶▶▶” appears in the upper right corner of the TV screen.
To display previous tracks, press PREV or ◀◀.
To switch to the digest of another disc during disc digest
Press D. SKIP during disc digest.





Locating a section within a track

— *Track Digest*

You can divide a VIDEO CD track into nine different sections and display the first scene of each section on the TV screen.

- 1 Press **SPECIAL MENU**.
- 2 Press 3 to select **"3) TRACK DIGEST."**
The current track is divided into nine sections and the first frame of each section is displayed.
The sound of the first three seconds of each section on an audio CD plays, but there is no sound when using a VIDEO CD.
- 3 Press the numeric buttons to select the section you want.
Playback starts from a point near the selected frame.

To switch to the digest of another track during track digest
Press **PREV/◀◀** or **NEXT/▶▶** during track digest.

- Notes
- Tracks less than 40 seconds long may be divided into fewer than nine sections.
 - You cannot use this function during Shuffle Play or Program Play.

Resuming playback from the point you stopped a VIDEO CD

— *Resume Play*

The unit memorizes the point where you stopped the VIDEO CD so you can resume from that point. Resume play is not cancelled when you turn off the system.

Resume Play is not available for an audio CD.

- 1 While playing a VIDEO CD, press **■** to stop playback.
"RESUME" appears on your TV screen. If "RESUME" does not appear, Resume Play is not available.

- 2 Press **◀▶**.

The player starts playback from the point you stopped the VIDEO CD in step 1.

To view from the beginning of the VIDEO CD

When "RESUME" appears in the display, press **■**, then press **◀▶**.

Notes

- Resume Play is not available in the Digest, Shuffle, or Program Play modes.
- Depending on where you stopped the VIDEO CD, the player may resume playback from a different point.
- Resume play is cancelled when:
 - you press numeric buttons, **PLAY MODE**, **■**, **DISC SKIP EX-CHANGE** (or **D. SKIP** on the remote), **SPECIAL MENU** or **◀◀/▶▶**.
 - you remove the VIDEO CD.
 - you unplug the unit's AC power cord.

Adjusting the picture

— *Picture Effect*

You can adjust the hue and sharpness of the picture.

- 1 Press **PICTURE EFFECT** during playback.
- 2 Press cursor **◀** or **▶** repeatedly to adjust the hue.
- 3 Press cursor **▲** or **▼** repeatedly to adjust the sharpness.
- 4 Press **ENTER** or **PICTURE EFFECT**.

Tip

The hue and sharpness can be adjusted in 11 steps (from -5 to +5).



Presetting radio stations

You can preset 20 stations for FM and 10 stations for AM.

- 1 Press **TUNER/BAND** repeatedly to select **FM** or **AM**.
- 2 Press and hold **▶▶** or **◀◀** (or **TUNING +/-** on the remote) until the frequency indication starts to change, then release.

Scanning stops when the system tunes in a station. "TUNED" and "STEREO" (for a stereo program) appear.

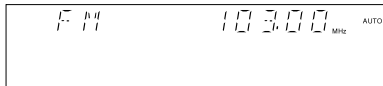

- 3 Press **TUNER MEMORY**.

A preset number appears in the display.

Preset number

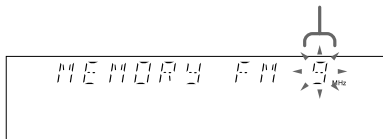

- 4 Press **◀◀** or **▶▶** to select the preset number you want to store.
- 5 Press **ENTER**.
"COMPLETE" appears in the display.
The station is stored.
- 6 Repeat steps 1 to 5 to store other stations.

To tune in a station with a weak signal

Press **▶▶** or **◀◀** (**TUNING +/-** on the remote) repeatedly to tune in the station manually.

To change the AM tuning interval

The AM tuning interval is factory set to 9 kHz (10 kHz in some areas). To change the AM tuning interval, select any AM station first, then turn off the power. While holding down the **ENTER** button, turn the power back on. When you change the interval, AM preset stations will be erased. To reset the interval, repeat the same procedure.

Tips

- The preset stations are retained for half a day even if you unplug the power cord or if a power failure occurs.
- Pressing **TUNER/BAND** while the power is off automatically turns the power on and **TUNER** is selected as a function. When the system is in the power saving mode, this function does not work.

Tuner

Listening to the radio

— Preset Tuning

Preset radio stations in the tuner's memory first (see "Presetting radio stations").

- 1 Press **TUNER/BAND** repeatedly to select **FM** or **AM**.
- 2 Press **◀◀** or **▶▶** (or press **PRESET +/-** on the remote) to tune in the preset station you want.

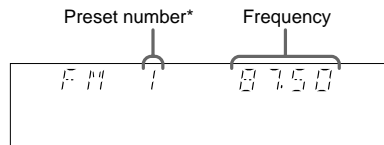

To Turn off the radio

Press **I/⏻**.

To listen to non-preset radio stations

Press **▶▶** or **◀◀** (or **TUNING +/-** on the remote) repeatedly for manual tuning or press and hold **▶▶** or **◀◀** (or **TUNING +/-** on the remote) for automatic tuning.

Tips

- When an FM program is noisy, press **FM MODE** so that "MONO" appears in the display. There will be no stereo effect, but the reception will improve.
- To improve broadcast reception, reorient the antennas.



Tape

Loading a tape

- 1 Press **TAPE A/B** repeatedly to select **Deck A or B**.
- 2 Press **▲** on the selected deck.
- 3 Insert a recorded tape in deck **A or B** with the side you want to play facing forward.

Insert with the side you want to play/record facing forward.

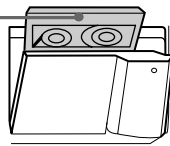

Playing a tape

You can use **TYPE I** (normal) or **TYPE II** (CrO₂)* tapes.

* MHC-VX777 only

- 1 **Load a tape.**
- 2 Press **DIRECTION** repeatedly to select **↔** to play one side. Select **↔↔** to play both sides. Select **RELAY*** (relay play) to play both decks in succession.
- 3 Press **◀▶**. Press **◀▶** again to play the reverse side. The tape starts playing.

Tape presence indicator

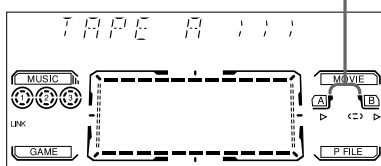

* Relay Play always follow this cyclic sequence:
Deck A (front side) → Deck A (reverse side) → Deck B (front side) → Deck B (reverse side)

To	Do this
Stop play	Press ■ .
Pause	Press ⏸ . Press again to resume play.
Fast-forward	Press ⏩ while playing the front side, or press ⏪ while playing the reverse side.
Rewind	Press ⏪ while playing the front side, or press ⏩ while playing the reverse side.

Tips

- During Cycle or Relay Play, the deck stops automatically after repeating the sequence five times.
- Pressing **TAPE A/B** while the power is off automatically turns the power on and **TAPE** is selected as a function. When the system is in the power saving mode, this function does not work.
- When you want to reduce the hiss noise in low-level high-frequency signals, press **DOLBY NR** so that "DOLBY NR" appears (MHC-VX777 only).
- When a tape (tapes) is (are) inserted, corresponding presence indicators light up.

Searching for the beginning of a track (AMS*)

During playback, press **⏪** or **⏩** repeatedly for the number of songs you want to skip forward (or backward).

The search direction, + (forward) or - (back), and number of songs being skipped (1-9) appear in the display.

Example: searching forward 2 songs

T A P E A > > + 2

* AMS (Automatic Music Sensor)

Note

The AMS function may not operate correctly under the following circumstances:

- When the unrecorded space between songs is less than 4 seconds long.
- When the unit is placed near a television.

Tape



Recording to a tape

— CD Synchro Recording/High Speed Dubbing/Recording Manually/ Program Edit

You can record from a CD, tape or radio. You can use TYPE I (normal) or TYPE II (CrO₂)* tapes. The recording level is adjusted automatically.*

* MHC-VX777 only

Steps	Recording from a CD (CD Synchro Recording)	Recording from a tape (High-Speed Dubbing)	Recording Manually
1	Insert a recordable tape into deck B.		
2	Press CD.	Press TAPE A/B to select TAPE A.	Press CD, TAPE A/B or TUNER/BAND.
3	Load the CD you want to record.	Load the tape you want to record into deck A.	Load the CD/tape, or tune to the station you want to record.
4	Press CD SYNC HI-DUB. DECK B stands by for recording. Press DOLBY NR to reduce the hiss noise in low level high frequency signals (for MHC-VX777 only) (except recording from a tape). REC PAUSE/START button flashes.		Press REC PAUSE/START.
5	Press DIRECTION repeatedly to select ⇄ to record on one side. Select ⇄ (or RELAY) to record on both sides.		
6	Press REC PAUSE/START. If you are recording manually, press ◀▶ to start playing the source. Recording starts.		
7	Press ■ to stop recording.		

Tips

- When you record on both sides, be sure to start from the front side. If you start from the reverse side, recording stops at the end of the reverse side.
- If you want to record from the reverse side, press TAPE A/B to select deck B after step 1. Press ▶◀ to start playback of the reverse side, then press ■ when you want to start recording. The TAPE B reverse side indicator lights up.
- If you set direction to ⇄ when the tapes you use have different lengths, the tapes in each deck reverses independently. If you select RELAY, the tapes in both decks reverse together.
- For recording from the radio:
If noise is heard while recording from the radio, move the respective antenna to reduce the noise.

- For recording from a CD to a tape manually, you can press ◀◀ or ▶▶ to select tracks during recording pause mode (after step 4 and before step 6).

Note

You cannot listen to other sources while recording.





Recording a CD by specifying track order

— Program Edit

You can record tracks from all the CDs in the order you want. When programming, make sure the playing times for each side do not exceed the length of one side of the tape.

- 1 **Load a CD and a recordable tape into deck B, then press CD.**
- 2 **Press PLAY MODE repeatedly until “PROGRAM” appears in the display.**
- 3 **Press one of the DISC 1–3 to select a CD.**
To program all the tracks on a CD at once, proceed to step 6 while “AL” appears in the display.
- 4 **Press ◀◀ or ▶▶ repeatedly until the tracks you want appears in the display.**
- 5 **Press ENTER.**
The track(s) is (are) programmed. The program step number appears, followed by the total playing time.
- 6 **To program additional tracks, repeat steps 3 to 5.**
Skip step 3 to select tracks from the same disc.
- 7 **Press CD SYNC HI-DUB.**
Deck B stands for recording. To reduce hiss noise in low-level high frequency signals, press DOLBY NR so that “DOLBY NR” appears in the display. The REC PAUSE/START button flashes.
- 8 **Press DIRECTION to select ⇄ to record on one side or ⇅ (or RELAY) to record on both sides.**
- 9 **Press REC PAUSE/START.**
Recording starts.

To	Press
Cancel Program Edit	PLAY MODE repeatedly until “PROGRAM” or “SHUFFLE” disappears from the display.
Clear a track from the end	CLEAR on the remote in stop mode.

Tip

To check the required tape length for recording a CD, press EDIT until “EDIT” flashes after you have loaded a CD and pressed CD. The required tape length for the currently selected CD appears, followed by the total playing time for side A and side B respectively (Tape Select Edit).

Note

You cannot use Tape Select Edit for discs containing over 20 tracks.

Tape

Timer-recording radio programs

To timer-record, you must preset the radio station (see “Presetting radio stations” on page 17) and set the clock (see “Setting the time” on page 8) beforehand.

- 1 **Tune in the preset radio station (see “Listening to the radio” on page 18).**
- 2 **Press CLOCK/TIMER SET on the remote.**
“DAILY 1 SET” appears.
- 3 **Press cursor ▼/▲ repeatedly to select “REC SET”, then press ENTER.**
“ON” appears and the hour indication flashes in the display.
- 4 **Set the time to start recording.**
Press cursor ▼/▲ repeatedly to set the hour, then press ENTER.
The minute indication starts flashing.
Press cursor ▼/▲ repeatedly to set the minute, then press ENTER.
The hour indication flashes again.

continued



**Timer-recording radio programs
(continued)**

5 Set the time to stop recording following the above procedure.

The start time appears, followed by the stop time, the preset radio station to be recorded (e.g., "TUNER FM 5"), then the original display appears.

6 Insert a recordable tape into deck B.

Make sure the tape is in forward direction.

7 Turn off the power.

When the recording starts, the volume level is set to the minimum.

To	Do this
Check the setting	Press CLOCK/TIMER SELECT on the remote and press cursor ▼/▲ repeatedly to select "REC SEL". Then, press ENTER. To change the setting, start over from step 1.
Cancel timer operation	Press CLOCK/TIMER SELECT on the remote and press cursor ▼/▲ repeatedly to select "TIMER OFF". Then, press ENTER.

Notes

- You cannot activate the Timer-recording and Daily Timer at the same time.
- When you used the Sleep Timer, Daily Timer and Timer recording will not turn on the system until the Sleep Timer turns it off.
- If the power is on at the preset time, the Timer recording does not work.
- The power turns on 15 seconds before the preset time.



Sound Adjustment

Adjusting the sound

You can reinforce the bass and create a more powerful sound.

Press GROOVE.

Each time you press this button, the display changes cyclically as follows:

V-GROOVE → GROOVE → GROOVE OFF

GROOVE

The volume switches to power mode and the equalizer curve changes.

V-GROOVE

The lower bass frequency of the music you are listening to is powerfully reinforced, the equalizer curve changes and loudness is increased.

Selecting the sound system

(MHC-VX777 only)

You can enjoy different sounds by selecting the sound mode you want.

Press SURROUND SPEAKER MODE to select the sound mode you want.

LINK : Reproduces the same sound with the different output level.

MATRIX SURR : Reproduces a wide range of sound that actually can sense the size of the room.



Selecting the audio emphasis effect

The audio emphasis menu lets you select the sound characteristics according to the sound you are listening to.

Selecting the preset effect from the music menu

Press MUSIC EQ, MOVIE EQ or GAME EQ (or PRESET EQ on the remote) repeatedly to select the preset effect you want.

The preset effect name appears in the display. See the chart "Music menu options".

To Cancel the effect

Press EFFECT ON/OFF repeatedly until "EFFECT OFF" appears.

Music menu options

"SURR" appears if you select an effect with surround effects.

MENU button	Effect	For
MUSIC EQ	ROCK POP JAZZ DANCE SOUL ORIENTAL*	standard music sources.
MOVIE EQ	ACTION DRAMA MUSICAL	soundtracks and special listening situations.
GAME EQ	ARCADE RACING ADVENTURE	Video games.

* CLASSIC for Latin American models only.



Adjusting the graphic equalizer

You can adjust the sound by raising or lowering the levels of specific frequency ranges.

Before operation, first select the audio emphasis you want for your basic sound.

1 Press one of the cursor ◀/▶/▲/▼.

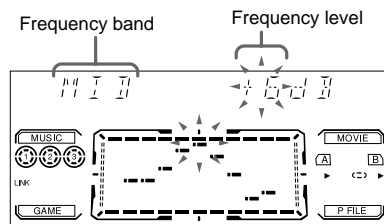

2 Press cursor ◀/▶ to select the frequencies or surround, then press cursor ▲/▼ to adjust the frequencies level or to select the surround effect.

3 Press ENTER to exit.

Selecting the surround effect

You can enjoy this system's surround effect.

Press CINEMA SPACE repeatedly to select the surround effect you want.

Each time you press the button, the display changes cyclically as follows:

SURR OFF → C. SPACE LOW →
C. SPACE MID → C. SPACE HIGH →
SURR ON

Note

When you choose other sound effects, the surround effect will be canceled.

Making a personal audio emphasis file

— Personal file

You can create a personal file of sound effect settings (surround effect and graphic equalizer) and store them in the memory of the unit. You can create up to three personal files.

Before operation, first select the audio emphasis you want for your basic sound.

1 Obtain the sound effect you want by changing the graphics equalizer and surround effect.

2 Press and hold down P File.

The personal file number appears in the display.

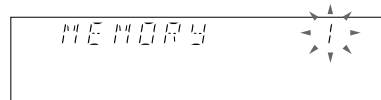

3 Use cursor ◀/▶/▲/▼ to select the personal file number (P FILE) which you want to store the sound effect settings.

4 Press ENTER.

The adjusted sound effect are stored under the selected personal file. The settings previously stored at this memory location are erased and replaced by a new settings.

To call up the personal file

Press P FILE repeatedly until the personal file number you want appears in the display.

Other features

Changing the spectrum analyzer display

You can enjoy changing the display while listening to the music.

Press SPECTRUM.

Each time you press the button, the display changes cyclically as follows:

SPECTRUM 1 → SPECTRUM 2 →
SPECTRUM 3 → PATTERN 1 →
PATTERN 2 → PATTERN 3 →
PATTERN OFF*

* The display slightly dims

Singing along: Karaoke

You can sing along with any stereo CD or tape by turning down the singer's voice. You need to connect an optional microphone.

1 Turn MIC LEVEL to MIN to turn down the microphone control level.

2 Connect an optional microphone to MIC 1 or MIC 2.

3 Press KARAOKE PON.

Each time you press the button, the display changes cyclically as follows:

KARAOKE PON → MPX R* →
MPX L* → KARAOKE OFF

* Only for CD.

The "🎤" indicator appears in the display when a karaoke mode is activated.

To sing karaoke by decreasing the vocal level of the music source, select "KARAOKE PON".

To sing karaoke of multiplex CD select "MPX R" or "MPX L".

4 Start playing the music and adjust the volume.

5 Adjust the microphone volume by turning MIC LEVEL.

To	Do this
Use VIDEO CDs	Turn on your TV and select the video input.
Cancel karaoke mode	Turn MIC LEVEL to MIN and disconnect the microphone from MIC 1 or MIC 2, then press KARAOKE PON repeatedly until "🎤" disappears.
Adjust the microphone echo	Turn ECHO LEVEL to adjust the echo effect. To cancel the echoing, turn ECHO LEVEL to the MIN.
Adjust the key	Press KEY CONTROL # or ♯ on the remote to suit your vocal range. You can adjust the key higher or lower in 13 halftone steps (♭6 ~ #6). This function can be used on the CD function only.

Tip

You can use two microphones connecting to MIC 1 or MIC 2 at the same time.

Notes

- With some songs, vocals may not be canceled when you select "KARAOKE PON".
- During KARAOKE PON, equalizer and surround settings cannot be changed.
- If you press EFFECT ON/OFF or recall a sound effect, the karaoke mode is canceled.



Mixing and recording sounds

You can “mix” sounds by playing one of the components and singing or speaking into a microphone (not supplied).

The mixed sound can be recorded on a tape.

- 1 **Do the procedure for singing along (steps 1 through 5 on page 25). Then, insert a recordable tape in deck B.**
- 2 **Press one of the function buttons you want to record from (e.g., CD).**
When you want to record from TAPE A, press TAPE A/B repeatedly until TAPE A is selected.
- 3 **Press REC PAUSE/START.**
Deck B stands by for recording. The REC PAUSE/START button flashes.
- 4 **Press DIRECTION repeatedly to select \rightleftarrows to record on one side. Select \leftrightarrow (or RELAY) to record on both sides.**
- 5 **Press REC PAUSE/START.**
Recording starts.
- 6 **Press $\blacktriangleleft\blacktriangleright$ to start playing the source to be recorded.**
Start singing along with the music.

To stop recording
Press \blacksquare .

Tips

- If acoustic feedback (howling) occurs, move the microphone away from the speakers or change the direction of the microphone.
- If you want to record your voice through the microphone only, you can do so by selecting the CD function and not playing a CD.
- When high level sound signals are input, the unit automatically adjusts the recording level to prevent distortion of the recorded sound signal (Auto Level Control function).

Notes

- The instrumental sound may be reduced as well as the singer’s voice when the sound is recorded in monaural.
- The singer’s voice may not be reduced when:
 - only a few instruments are playing.
 - a duet is being played.
 - the source has strong echoes or chorus.
 - the singer’s voice deviates from the center.
 - the voice on the source is singing in high soprano or tenor.

Falling asleep to music

— Sleep Timer

You can let the system turn off at the preset time, so you can sleep to the music.

Press SLEEP on the remote.

Each time you press the button, the minute display (the turn-off time) changes as follows:

AUTO \rightarrow 90 \rightarrow 80 \rightarrow 70 \rightarrow ... \rightarrow 10 \rightarrow OFF \rightarrow AUTO* ...

* The power turns off when the current CD or tape finishes playback (for up to 100 minutes).

To	Press
Check the remaining time	SLEEP once.
Change the time to turn off	SLEEP to select the time you want.
Cancel the Sleep Timer function	SLEEP repeatedly until “SLEEP OFF” appears.





Waking up to music

— Daily Timer

You can wake up to music at a preset time every day. Make sure you have set the clock (see “Setting the time” on page 8).

- 1 Prepare the music source you want to play.**
 - CD: Load a CD. To start from a specific track, make a program (see “Programming the CD tracks” on page 13).
 - Tape: Load a tape with the side you want to play facing forward.
 - Radio: Tune in the preset station you want (see “Presetting radio stations” on page 17).
- 2 Adjust the volume.**
- 3 Press CLOCK/TIMER SET on the remote.**
“DAILY 1 SET” appears.
- 4 Press cursor ▼/▲ repeatedly to select “DAILY 1 (2) SET”, then press ENTER.**
“ON” appears and the hour digits flash in the display.
- 5 Set the time to start playback.**
Press cursor ▼/▲ repeatedly to set the hour, then press ENTER.
The minute indication starts flashing.
Press cursor ▼/▲ repeatedly on the remote to set the minute, then press ENTER.
The hour indication flashes again.
- 6 Set the time to stop playback following steps 4 and 5 above.**

- 7 Press cursor ▼/▲ repeatedly until the music source you want appears.**

The indications change as follows:

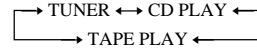

- 8 Press ENTER.**

The type of timer (DAILY 1 or DAILY 2), followed by the start time, stop time and the music source appears, then the original display appears.

- 9 Turn off the power.**

To	Do this
Check the setting	Press CLOCK/TIMER SELECT on the remote and press cursor ▼/▲ repeatedly to select the respective mode (DAILY 1 or DAILY 2), then press ENTER.
Change the setting	Start from step 1.
Cancel the timer operation	Press CLOCK/TIMER SELECT on the remote and press cursor ▼/▲ repeatedly to select “TIMER OFF”, then press ENTER.

Tip

The power turns on 15 seconds before the preset time.

Notes

- When you use the Sleep Timer, Daily Timer will not turn on the system until the Sleep Timer turns it off.
- If the power is on at the preset time, the Daily Timer does not work.

Optional components

Connecting MD deck/VCR

You can connect your MD deck or VCR to this system. Be sure to match the color of the plugs and the connectors.

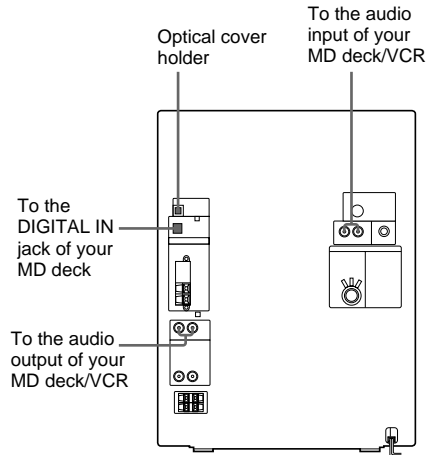

To	Do This
Make a digital recording from CD to MD	Connect the optical cable.
Make an analog recording from CD, TAPE or TUNER	Connect the AUDIO OUT jacks to the audio input of the MD deck.
Record the audio and video signals from VIDEO CD on to VIDEO TAPE	Connect the AUDIO OUT jacks to the audio input of VCR. Connect the VIDEO OUT jack to the video input of the VCR.
Listen to the connected MD deck	Press MD (VIDEO).
Listen to the connected VCR	Hold down MD (VIDEO) and press I/⏻ when the power is on. This switches the "MD" function to "VIDEO". Once you enable the "VIDEO" function, just press MD (VIDEO).



Tip

When you remove the optical cover, keep it at the optical cover holder provided.

Note

If the sound is distorted or too loud when selecting "VIDEO", or you want to switch back to "MD", repeat the operation described above to switch to "MD".

Connecting a Video Game Player

You can enjoy the video games with audio emphasis by connecting a video game player.

To the audio/video output of a video game player.

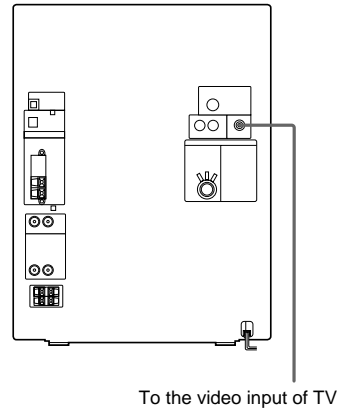
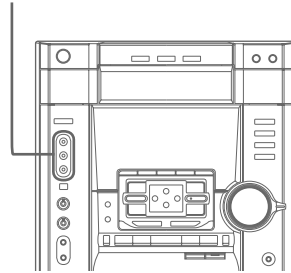



To	Press
Listen or watch the game	GAME (or GAME on the remote).
Select the music menu.	GAME EQ/MUSIC EQ/MOVIE EQ (or PRESET EQ on the remote). (See "Selecting the audio emphasis effect" page 23)

Notes

- Pressing the GAME while the power is off automatically turns the power on and GAME is selected as a function. When the system is in the power saving mode, this function does not work.
- If you press GAME, your last selected GAME EQ preset effect (ARCADE, RACING or ADVENTURE) will be restored.

Connecting external antennas

Connect an external antenna to improve the reception.

FM antenna

Connect an optional FM external antenna. You can also use the TV antenna instead.

Jack type Ⓐ

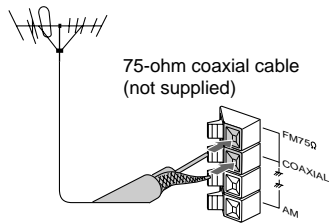

Jack type Ⓑ

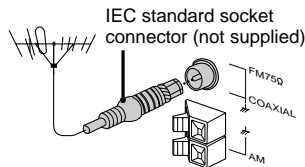

AM antenna

Connect a 6- to 15- meter (20- to 50- feet) insulated wire to the AM antenna terminal. Leave the supplied AM loop antenna connected.

Jack type Ⓐ

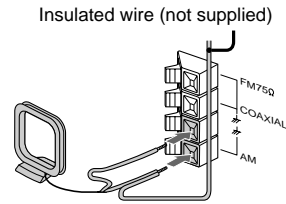

Jack type Ⓑ

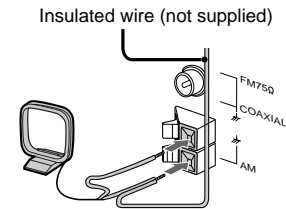

Optional components



Additional Information

Precautions

On operating voltage

Before operating the unit, check that the operating voltage of your unit is identical with the voltage of your local power supply.

On safety

- The unit is not disconnected from the AC power source (mains) as long as it is connected to the wall outlet, even if the unit itself has been turned off.
- Unplug the unit from the wall outlet (mains) if it is not to be used for an extended period of time. To disconnect the cord (mains lead), pull it out by the plug. Never pull the cord itself.
- Should any solid object or liquid fall into the component, unplug the unit and have the component checked by qualified personnel before operating it any further.
- The AC power cord must be changed only at the qualified service shop.

On placement

- Do not place the unit in an inclined position.
- Do not place the unit in locations where it is:
 - extremely hot or cold
 - dusty or dirty
 - very humid
 - vibrating
 - subject to direct sunlight

On heat build up

- Although the unit heats up during operation, this is not a malfunction.
- Place the unit in a location with adequate ventilation to prevent heat built-up in the unit.

If you continuously use this unit at a large volume, the cabinet temperature of the top, side and bottom rises considerably. To avoid burning yourself, do not touch the cabinet. To prevent a malfunction, do not cover the ventilation hole for the cooling fan.

On operation

- If the unit is brought directly from a cold to a warm location, or is placed in a very damp room, moisture may condense on the lens inside the CD player. Should this occur, the unit will not operate properly. Remove the CD and leave the unit turned on for about an hour until the moisture evaporates.
 - When you move the unit, take out any discs.
- If you have any questions or problems concerning your unit, please consult your nearest Sony dealer.

Notes on CDs

- Before playing, clean the CD with a cleaning cloth. Wipe the CD from the center out.
- Do not use solvents.
- Do not expose the CD to direct sunlight or heat sources.

Note on CD-R/CD-RW playback

Discs recorded on CD-R/CD-RW drives may not be played back because of scratches, dirt, recording conditions or the drive's characteristics. Besides, the discs, which are not yet finalized at the end of recording, cannot be played back.

To save a tape permanently

To prevent a tape from being accidentally recorded over, break off the cassette tab, refer to attached instruction with the tape.

Cleaning the cabinet

Use a soft cloth slightly moistened with mild detergent solution.

Before placing a cassette in the tape deck

Take up any slack in the tape. Otherwise the tape may get entangled in the parts of the tape deck and become damaged.

When using a tape longer than 90 minutes

The tape is very elastic. Do not change the tape operations such as play, stop, and fast-winding etc. frequently. The tape may get entangled in the tape deck.

Cleaning the tape heads

Clean the tape heads after every 10 hours of use.

When the tape heads become dirty:

- the sound is distorted
- there is a decrease in sound level
- the sound drops out
- the tape does not erase completely
- the tape does not record

Make sure to clean the tape heads before you start an important recording or after playing an old tape. Use separately sold dry-type or wet-type cleaning cassette. For details, refer to the instructions of the cleaning cassette.

Demagnetizing the tape heads

Demagnetize the tape heads and the metal parts that have contact with the tape every 20 to 30 hours of use with a separately sold demagnetizing cassette. For details, refer to the instructions of the demagnetizing cassette.

In case color irregularity is observed on nearby a TV screen

With the magnetically shielded type of speaker system, the speakers can be installed near a TV set. However, color irregularity may still be observed on the TV screen depending on the type of your TV set.



If color irregularity is observed...
Turn off the TV set once, then turn it on after 15 to 30 minutes.

If color irregularity is observed again...
Place the speakers farther away from the TV set.

Troubleshooting

If you run into any problem using this unit, use the following check list.

First, check that the power cord is connected firmly and the speakers are connected correctly and firmly.

Should any problem persist, consult your nearest Sony dealer.

General

The display starts flashing as soon as you plug in the power cord even though you haven't turned on the power (demonstration mode).

Press DISPLAY when the power is turned off.

The demonstration mode appears automatically the first time you plug in the power cord or if there is a power outage.

The clock setting is canceled.

- The power cord is disconnected or a power failure occurs. Redo "Setting the time" (on page 8). If you have set the timer, redo "Waking up to music" (on page 27) and "Timer-recording radio programs" (on page 21).

The radio presetting/timer setting is canceled.

- The power cord is disconnected or a power failure occurs for longer than half a day. Redo "Presetting radio stations" (on page 17).

There is no sound.

- Turn VOLUME clockwise.
- The headphones are connected.
- Insert only the stripped portion of the speaker cord into the SPEAKER jack. Inserting the vinyl portion of the speaker cord will obstruct the speaker connections.
- The protective device on the amplifier has been activated because of short circuit. ("PROTECT" and "PUSH POWER" flash alternately.) Turn off the unit, eliminate the short-circuit problem and turn on the power again.
- There is no audio output during timer recording.

There is severe hum or noise.

- A TV or VCR is placed too close to the stereo system. Move the stereo system away from the TV or VCR.

The sound from the connected source is distorted.

- If "VIDEO" appears in the display when you press MD (VIDEO), switch the display to "MD" (see "Note: Connecting MD deck/VCR" on page 28).

"-- --:-- --" flashes in the display.

- A power interruption occurred. Set the clock and timer settings again.

The timer does not function.

- Set the clock correctly.

DAILY 1 SET, DAILY 2 SET and REC SET do not appear when you press the CLOCK/TIMER SET button.

- Set the timer correctly.
- Set the clock.

The remote does not function.

- There is an obstacle between the remote and the system.
- The remote is not pointing in the direction of the system's sensor.
- The batteries have run down. Replace the batteries.

There is acoustic feedback.

- Decrease the volume level.
- Move the microphone away from the speakers or change the direction of the microphone.

The color irregularity on a TV screen persists.

- Turn off the TV set once, then turn it on after 15 to 30 minutes. If the color irregularity still persists, place the speakers farther away from the TV set.

"PROTECT" and "PUSH POWER" appear alternately.

- A strong signal was input. Press I/⏻ to turn off the power, leave the system turned off for a while, then press I/⏻ again to turn on the power.
- Check the speaker cables in case "PROTECT" and "PUSH POWER" appear alternately again after you turn the system on.



Speakers

Sound comes from one channel or unbalanced left and right volume.

- Check the speaker connection and speaker placement.

Sound lacks bass.

- Check that the speaker's + and – jacks are connected correctly.

VIDEO CD/CD Player

There is no picture.

- Check that the player is connected securely.
- Make sure you operate the TV correctly.
- Make sure you set the color system correctly, according to your TV (color) system.
- Press CD.

The CD tray does not close.

- The CD is not placed properly.

The CD will not play.

- The CD is not lying flat in the disc tray.
- The CD is dirty.
- The CD is inserted label side down.
- Moisture condensation has built up. Remove the CD and leave the system turned on for about an hour until the moisture evaporates.

Play does not start from the first track.

- The player is in program or shuffle mode. Press PLAY MODE repeatedly until "PROGRAM" or "SHUFFLE" disappears.

"OVER" is displayed.

- You have reached the end of the CD. Press ◀◀.

Tape Deck

The tape does not record.

- The tab has been removed from the cassette (see "To save a tape permanently" on page 30).
- The tape has reeled to the end.

The tape does not record nor play or there is a decrease in sound level.

- The heads are dirty. Clean them (see "Cleaning the tape heads" on page 30).
- The record/playback heads are magnetized. Demagnetize them (see "Demagnetizing the tape heads" on page 30).

The tape does not erase completely.

- The record/playback heads are magnetized. Demagnetize them (see "Demagnetizing the tape heads" on page 30).

There is excessive wow or flutter, or the sound drops out.

- The capstans or pinch rollers are dirty. Clean them (see "Cleaning the tape heads" on page 30).

Noise increases or the high frequencies are erased.

- The record/playback heads are magnetized. Demagnetize them (see "Demagnetizing the tape heads" on page 30).

Tuner

Severe hum or noise ("TUNED" or "STEREO" flashes in the display).

- Adjust the antenna.
- The signal strength is too weak. Connect the external antenna.

A stereo FM program cannot be received in stereo.

- Press FM MODE so that "MONO" disappears.

If other troubles not described above occur, reset the system as follows:

1 Press ■, ENTER and I/⏻ at the same time.

2 Unplug the power cord.

3 Plug the power cord back in.

4 Press I/⏻ to turn on the power.

The unit is reset to factory settings. All the settings you made are cleared.



Specifications

Amplifier section

MHC-VX777

The following measured at AC 120, 220, 240V, 50/60 Hz

DIN power output (rated) 160 + 160 watts
(6 ohms at 1 kHz, DIN)

Continuous RMS power output (reference)
200 + 200 watts
(6 ohms at 1 kHz, 10% THD)

MHC-VX555/VX555J

The following measured at AC 120, 220, 240V, 50/60 Hz

DIN power output (rated) 100 + 100 watts
(6 ohms at 1 kHz, DIN)

Continuous RMS power output (reference)
140 + 140 watts
(6 ohms at 1 kHz, 10% THD)

Inputs

GAME (VIDEO): 1 Vp-p, 75 ohms
(phono jack)

GAME (AUDIO): Voltage 250 mV,
impedance 47 kilohms
(phono jacks)

MD/VIDEO (AUDIO) IN: voltage 450 mV/250 mV,
impedance 47 kilohms
(phono jacks)

MIC 1/2: sensitivity 1 mV,
impedance 10 kilohms
(phone jack)

Outputs

VIDEO OUT: max. output level 1 Vp-p,
(phono jacks) unbalanced, Sync.
negative load impedance
75 ohms

S. VIDEO OUT: Y: 1 Vp-p, unbalanced
(4 pin/mini-DIN jack) Sync negative

C: 0.286 Vp-p, load
impedance 75 ohms

AUDIO OUT: Voltage 140 mV,
(phono jack) impedance 47 kilohms.

PHONES: accepts headphones of 8
(stereo mini jack) ohms or more

FRONT SPEAKER: accepts impedance of 6 to
16 ohms

SURROUND SPEAKER: accepts impedance of
24 ohms or more

VIDEO CD/CD player section

System Compact disc and digital
audio system

Laser Semiconductor laser
($\lambda=795\text{nm}$)

Laser Output Max. 44.6 μW *
*This output is the value
measured at a distance of
200 mm from the
objective lens surface on
the Optical Pick-up Block
with 7 mm aperture.

Frequency response 2 Hz – 20 kHz (± 0.5 dB)

Wave length 780 – 790 nm

Signal-to-noise ratio More than 90 dB

Dynamic range More than 90 dB

Video color system format

NTSC, PAL

CD OPTICAL DIGITAL OUT

(Square optical connector jack, rear panel)

Wave length 660 nm

Output level -18 dBm

Tape player section

Recording system 4-track 2-channel stereo

Frequency response 40 – 13,000 Hz (± 3 dB),
(DOLBY NR OFF*)

using Sony TYPE I
cassette

40 – 14,000 Hz (± 3 dB),
using Sony TYPE II
cassette*

Wow and flutter $\pm 0.15\%$ W.Peak (IEC)
0.1% W.RMS (NAB)
 $\pm 0.2\%$ W.Peak (DIN)

* MHC-VX777 only

Tuner section

FM stereo, FM/AM superheterodyne tuner

FM tuner section

Tuning range 87.5 – 108.0 MHz

Antenna FM lead antenna

Antenna terminals 75 ohm unbalanced

Intermediate frequency 10.7 MHz

AM tuner section

Tuning range

Latin American models: 530 – 1,710 kHz
(with the interval set at
10 kHz)

531 – 1,710 kHz
(with the interval set at
9 kHz)

Middle Eastern models: 531 – 1,602 kHz
(with the interval set at
9 kHz)

Other models: 531 – 1,602 kHz
(with the interval set at
9 kHz)

530 – 1,710 kHz
(with the interval set at
10 kHz)

Antenna AM loop antenna

Antenna terminals External antenna terminal

Intermediate frequency 450 kHz

Speaker

Front speaker SS-VX888 for MHC-VX777

Front speaker SS-VX555 for MHC-VX555

Front speaker SS-VX555J for MHC-VX555J

Speaker system 3-way, 3-unit,
bass-reflex type,
magnetically shielded

Speaker units

Super Woofer: 15 cm, cone type

Woofer: 15 cm, cone type

Tweeter: 5 cm, cone type

Nominal impedance 6 ohms

Dimensions (w/h/d) Approx. 250 x 385.4 x

326 mm

Mass Approx. 6.7 kg net per
speaker



Surround speaker SS-RS70V for MHC-VX777

Speaker system	2 way, 2 unit, bass-reflex type, magnetically shielded
Speaker units	
Woofer	13 cm, cone type
Tweeter	4 cm, cone type
Nominal impedance	24 ohms
Dimensions (w/h/d)	Approx. 174 x 360 x 260 mm
Mass	Approx. 3.4 kg net per speaker

Surround speaker SS-RS50V for MHC-VX555/ VX555J

Speaker system	Full range, bass-reflex type, magnetically shielded
Speaker units	
Woofer	8 cm, cone type
Nominal impedance	24 ohms
Dimensions (w/h/d)	Approx. 180 x 102.2 x 198 mm
Mass	Approx. 0.8 kg net per speaker

General

Power requirements	
Australian models:	230 – 240 V AC, 50/60 Hz
Mexican models:	120 V AC, 60 Hz
Thailand models:	220 V AC, 50/60 Hz
Other models:	120 V, 220 V or 230 – 240 V AC, 50/60 Hz Adjustable with voltage selector

Power consumption	
MHC-VX777	250 watts
MHC-VX555/VX555J	270 watts

Dimensions (w/h/d)	
HCD-VX777/VX555/ VX555J	Approx. 280 x 360 x 425 mm

Mass :	
HCD-VX777	Approx. 11 kg
HCD-VX555/VX555J	Approx. 10.5 kg

Supplied accessories:	AM loop antenna (1) Remote commander (1) Batteries (2) Video cable (1) FM lead antenna (1) Front speaker pads (8) Surround speaker pads (8) (MHC-VX777 only)
-----------------------	---

Design and specifications are subject to change
without notice.



Glossary

Auto Pause

An automatically pauses according to the signal encoded on the disc while playing a VIDEO CD. If the CD player does not resume play for a long time, press ◀▶ to resume play manually.

Menu Playback

Playback using the menu screens recorded on VIDEO CDs with PBC functions. You can enjoy simple interactive software using the menu playback function.

Playback Control (PBC)

Signals encoded on VIDEO CDs (Version 2.0) to control playback.

By using menu screens recorded on VIDEO CDs with PBC functions, you can enjoy playing simple interactive software, software with search functions, and so on.

When you select a VIDEO CD with PBC functions on this player, the PBC indicator lights up.

Track

Sections of a picture or a music piece on disc. Each track is assigned a track number to help you locate the track you want.

VIDEO CD

A compact disc which contains moving pictures.

VIDEO CDs contain compact picture information using the MPEG 1 format, one of the world wide standards of digital compact technology. The picture information is compressed about 120 times. Consequently, a 12 cm VIDEO CD can contain up to 74 minutes of moving pictures.

VIDEO CDs also contain compact audio information. Sounds outside the range of human hearing are compressed while the sounds we can hear are not compressed. VIDEO CDs can hold six times the audio information of conventional audio CDs.

There are two versions for VIDEO CDs:

Version 1.1 (VIDEO CDs without PBC functions):

You can play only moving pictures and sounds.

Version 2.0 (VIDEO CDs with PBC functions):

You can play still pictures and enjoy PBC functions.

This player can play to both versions.



Sony Corporation Printed in Malaysia

<http://www.world.sony.com/>

10ADD_MHC-VX777/VX555.p65 GB

36

13/03/2001, 5:00 PM

MHC-VX777/VX555/VX555J 4-232-651-12 (1)