

Micro Hi-Fi Component System

Operating Instructions



MDLP

CMT-DC500MD

WARNING

To prevent fire or shock hazard, do not expose the unit to rain or moisture.

To avoid electrical shock, do not open the cabinet. Refer servicing to qualified personnel only.

Do not install the appliance in a confined space, such as a bookcase or built-in cabinet.

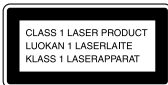

This appliance is classified as a CLASS 1 LASER product. The CLASS 1 LASER PRODUCT MARKING is located on the rear exterior.

The following caution label is located inside the apparatus.



To prevent fire, do not cover the ventilation of the apparatus with news papers, table-cloths, curtains, etc. And don't place lighted candles on the apparatus.

To prevent fire or shock hazard, do not place objects filled with liquids, such as vases, on the apparatus.

IN NO EVENT SHALL SELLER BE LIABLE FOR ANY DIRECT, INCIDENTAL OR CONSEQUENTIAL DAMAGES OF ANY NATURE, OR LOSSES OR EXPENSES RESULTING FROM ANY DEFECTIVE PRODUCT OR THE USE OF ANY PRODUCT.



Don't throw a battery, dispose it as the injurious wastes.

Table of Contents

Parts Identification

Main unit	4
Remote control	5

Getting Started

Hooking up the system	6
Inserting two size-AA (R6) batteries into the remote control	7
Replacing accessories	7
Setting the time	9
Conserving power in standby mode	9

CD

Loading the CD	10
Playing the CD	
— Normal Play/Shuffle Play/ Repeat Play	10
Programing the CD tracks	
— Program Play	12
Using the CD display	13
Labeling a CD	
— Disc Memo	13

MD — Play

Loading the MD	15
Playing the MD	
— Normal Play/Shuffle Play/ Repeat Play	15
Programing the MD tracks	
— Program Play	16
Using the MD display	17

MD — Recording

Before you start recording	18
After recording	18
Recording a CD on an MD	
— CD-MD Synchro Recording	19
Recording a tape on an MD	
— TAPE-MD Synchro Recording	20
Recording on an MD manually	
— Manual Recording	21
Starting recording with 6 seconds of prestored audio data	
— Time Machine Recording	21
Recording tips	
— Recording for long times/Marking track numbers/Smart space/Adjusting the recording level	22

MD — Editing

Before you start editing	26
Labeling an MD	
— Name Function	26

Erasing recordings	
— Erase Function	29
Moving recorded tracks	
— Move Function	31
Dividing recorded tracks	
— Divide Function	31
Combining recorded tracks	
— Combine Function	32
Undoing the last edit	
— Undo Function	33
Changing the recording level after recording	
— S.F Edit	34

Tuner

Presetting radio stations	36
Listening to the radio	
— Preset Tuning	37
Labeling the preset stations	
— Station Name	38
Using the Radio Data System (RDS)*	38

Tape — Play

Loading a tape	39
Playing a tape	39

Tape — Recording

Recording a CD on a tape	
— CD-TAPE Synchro Recording	40
Recording an MD on a tape	
— MD-TAPE Synchro Recording	40
Recording on a tape manually	
— Manual Recording	41

Sound Adjustment

Adjusting the sound	42
---------------------------	----

Timer

Falling asleep to music	
— Sleep Timer	42
Waking up to music	
— Daily Timer	43
Timer recording radio programs	44

Optional Components

Hooking up the optional components	45
--	----

Additional Information

Precautions	46
System limitations of MDs	48
Troubleshooting	49
Self-diagnosis display	53
Specifications	55

* European model only

The items are arranged in alphabetical order.

Refer to the pages indicated in parentheses () for details.

Main unit

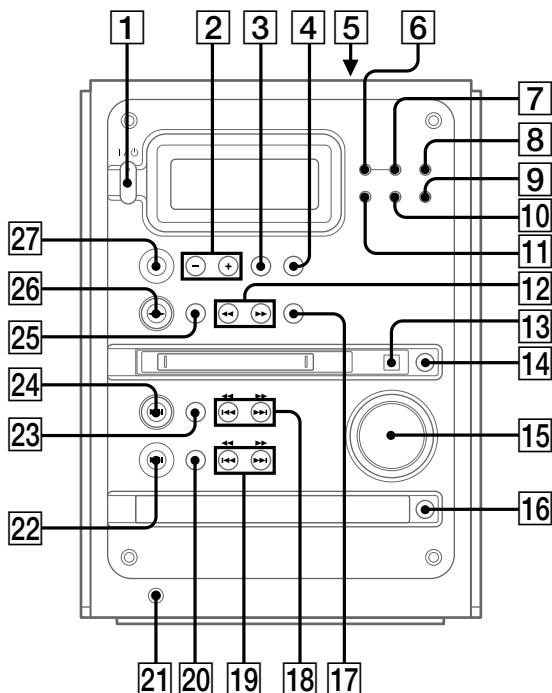

BAND **27** (36, 37)
 CD ▲ **16** (10, 11)
 CD ◀▶▶▶ **19** (11, 12)
 CD ▶▶▶▶ **19** (11)
 CD ■ **20** (11, 12, 19, 40)
 CD ▶▶ **22** (10–12)
 ENTER/START **7** (19, 20, 40, 41)
 FUNCTION **9** (10, 12, 15, 16, 21–24, 39, 41, 45)
 MD ▲ **14** (15, 16, 18, 26)
 MD ◀▶▶▶▶ **18** (15–17, 52)
 MD ◀▶▶▶▶ **18** (15)
 MD ■ **23** (15, 17, 19–22, 40, 41)
 MD ▶▶ **24** (15–17, 21)

PHONES jack **21**
 PLAY MODE/DIRECTION **3**
 (10, 12, 13, 15–17, 26, 34, 39–41)
 REC MODE **8** (22)
 Remote sensor **13**
 REPEAT **4** (11, 15, 36)
 STEREO/MONO **4** (37)
 SYNCHRO REC **6** (19, 20, 40)
 TAPE ◀▶▶▶▶ **12** (39)
 TAPE **17** (39, 41)
 TAPE ■ **25** (20, 39–41, 52)
 TAPE ◀▶ **26** (39–41)
 TUNING MODE **3** (36, 37)
 TUNING +/- **2** (36, 37)
 VOLUME **15**

BUTTON DESCRIPTIONS

- ⏻ (power) **1** (7, 18, 26, 37, 43, 45, 52)
- MD **11** (21, 24, 25, 52)
- ▲ PUSH **5** (39)
- TAPE **10** (41)

Remote control

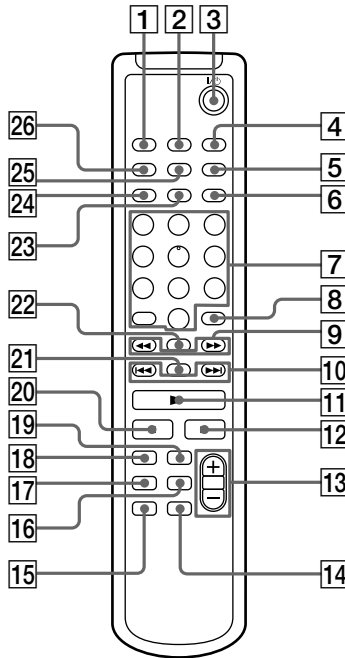

BASS/TRE **5** (42)
 CD **17** (10, 12, 13)
 CLEAR **8** (12, 14, 16, 17, 27, 38)
 CLOCK/TIMER SELECT **2** (44, 45)
 CLOCK/TIMER SET **4** (9, 43, 44)
 CURSOR ←/→ **9** (9, 14, 27)
 DISPLAY **21** (9, 12, 13, 17, 21, 38)
 DSG **14** (42)
 ENTER/YES **6** (9, 12, 14, 16, 21–36, 38, 43–45)
 FUNCTION **15** (10, 12, 15, 16, 21–24, 39, 41, 45)

MD **18** (15, 16, 30–32, 34)
 MENU/NO **24** (14, 22–36)
 NAME EDIT/SELECT **23** (13, 14, 26, 27, 38)
 Number buttons **7** (11–16, 17, 27, 37)
 PLAY MODE **26** (10, 12, 13, 15–17, 26, 34)
 REPEAT **25** (11, 15)
 SCROLL **22** (14, 17, 28)
 SLEEP **1** (42)
 TAPE **16**
 TUNER BAND **19** (36, 37)
 VOLUME +/- **13**

BUTTON DESCRIPTIONS

⏻ (power) **3** (7, 18, 26, 37, 43, 45)
 ⏪ ⏩ **9** (11, 15, 30, 32)
 ⏮ ⏭ **10** (9, 11–17, 22–25, 27–36, 42–45)
 ▶ **11** (10, 12, 15, 17, 25)
 ■ **12** (11, 12, 15, 17, 19, 20, 25)
 ■ **20** (11, 15)

Hooking up the system

Follow steps **1** through **4** of the procedure below to hook up your system using the supplied cords and accessories.

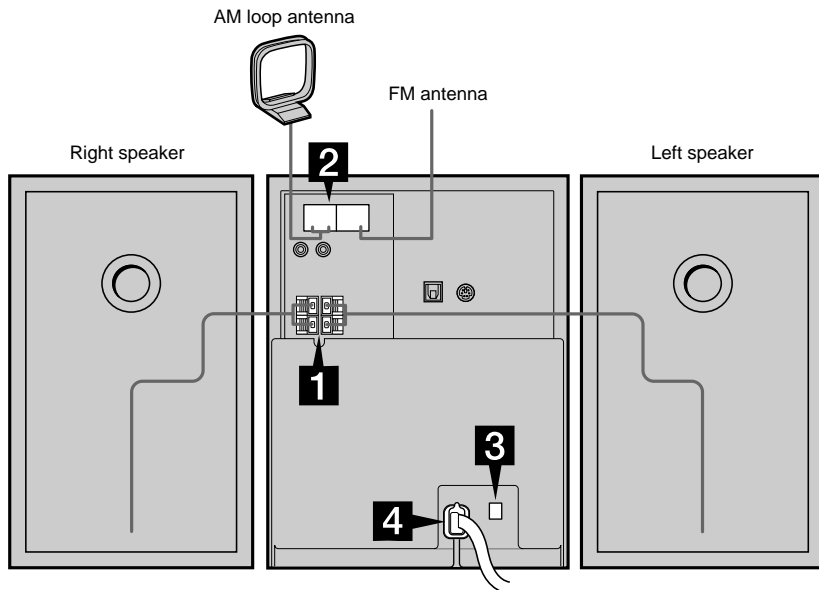

1 Connect the speakers.

Connect the right and left speaker cords to the SPEAKER terminals as shown below.

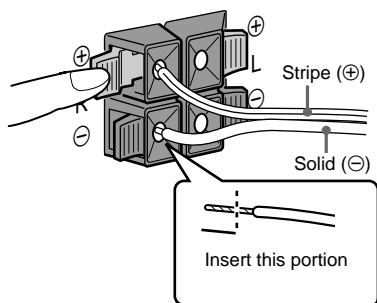

2 Connect the FM and AM antennas.

Set the AM loop antenna up before connecting it.

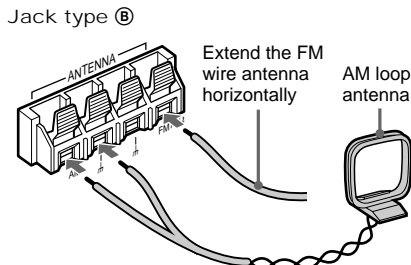
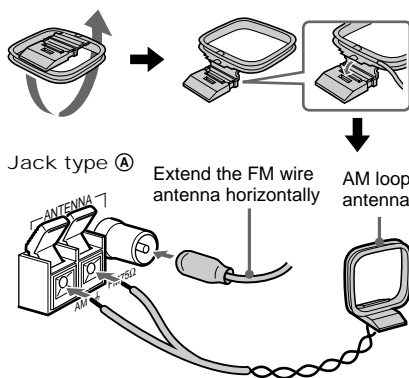

- 3** For models with a voltage selector, set **VOLTAGE SELECTOR** to the local power line voltage.



- 4** Connect the power cord to a wall outlet.

If the plug does not fit the wall socket, detach the supplied plug adaptor (only for models equipped with an adaptor).

To turn on the system, press **I/⏻**.

Inserting two size-AA (R6) batteries into the remote control

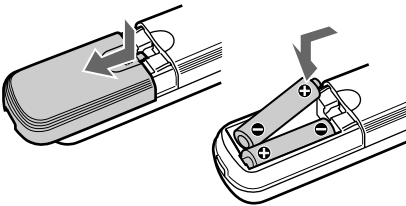

Tip

When the remote no longer operates the system, replace both batteries with new ones.

Note

If you do not use the remote for a long period of time, remove the batteries to prevent possible damage from battery leakage and corrosion.

Replacing accessories

You can replace the color trim, color window, and the speaker grille net cover.* Before replacing accessories, be sure to turn off the unit.

* Not supplied with the CMT-DC500MD/X

To remove the color trim

- 1** While pressing the release key down, lift up the trim on both sides.

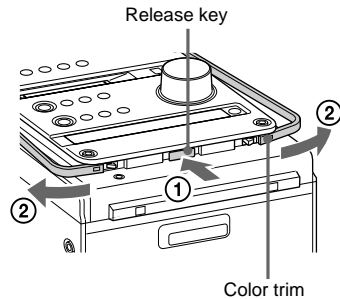

- 2** Lift the trim outward.

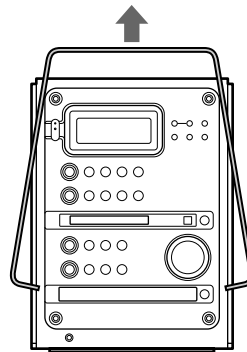

continued

Replacing accessories (continued)

To attach the color trim

While pressing the release key down, press the trim inward on both sides until the trim is locked by the spring.

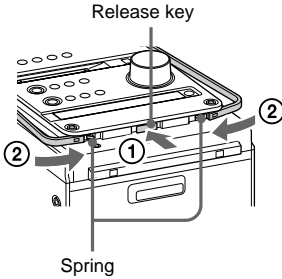

To remove the color window

- 1 After removing the color trim, press the tip of a toothpick or some other sharp instrument into the hole in the groove. The display window opens.

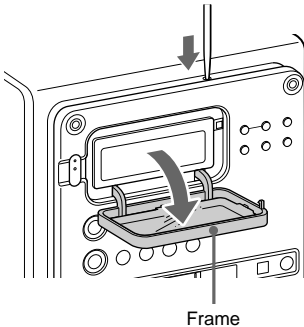

- 2 Push upward the color window to remove it from the frame.

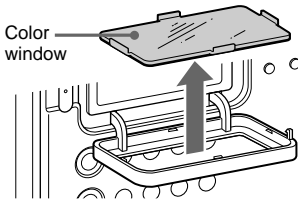

To remove the speaker grille net cover

The figure below shows the CMT-DC500MD/S.

- 1 Put your finger into the hollow space at the bottom of the baffle board, and pry the speaker grille net outward.

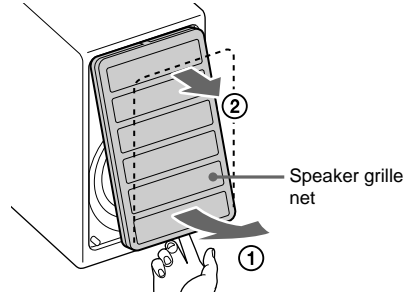

- 2 Remove the cover.

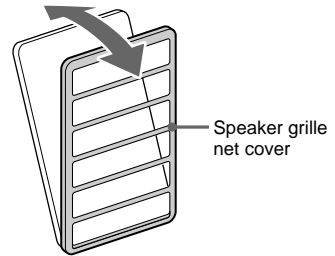

Setting the time

- 1 Turn on the system.
- 2 Press **CLOCK/TIMER SET** on the remote.
If you are setting the clock for the first time, go to step 5.
- 3 Press **◀** or **▶** on the remote repeatedly until **"CLOCK SET"** appears in the display.
- 4 Press **ENTER/YES** on the remote.
The hour indication flashes.
- 5 Press **◀** or **▶** on the remote repeatedly to set the hour.
- 6 Press **ENTER/YES** or **CURSOR→** on the remote.
The minute indication flashes.
- 7 Press **◀** or **▶** on the remote repeatedly to set the minute.
- 8 Press **ENTER/YES** on the remote.
The clock will begin operating.

To reset the system clock
Start over from step 1.

Conserving power in standby mode

Even if the system is off, the unit consumes power to power the clock and to stay responsive to commands from the remote. Power saving mode was introduced to reduce the amount of power consumed during standby. In this mode, the clock is not displayed.

To change to power saving mode, press DISPLAY on the remote repeatedly while the system is off until demonstration mode and the clock disappear from the display.

To change the display

Press **DISPLAY** on the remote repeatedly while the system is off.

The display changes as follows:

Demonstration mode → Clock display →
Power saving mode → Demonstration mode
→ ...

Tip

The timer continues to operate during power saving mode.

To cancel power saving mode

Press **DISPLAY** on the remote repeatedly while the system is off until demonstration mode or the clock display appears in the display.

Loading the CD

1 Press CD .

The disc tray slides out.

2 Load a CD onto the disc tray.

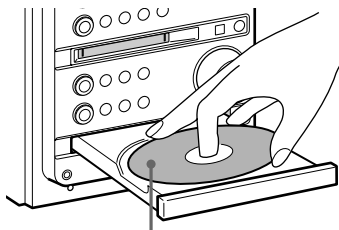

Load with the label side up. When you play a CD single (8 cm CD), load it onto the inner circle of the tray.

3 Press CD again to close the disc tray.

Note

If you press CD  to open or close the disc tray while listening to another sound source, the CD icon lights even if there is no CD in the tray.

To turn off the CD icon, press FUNCTION repeatedly to switch the function to CD.

Tip

You can stand a CD case upright in the groove on top of the system.

Playing the CD

— Normal Play/Shuffle Play/Repeat Play

This system lets you play CDs in different play modes.

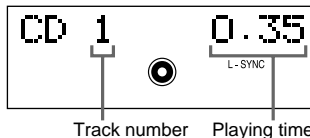

1 Press FUNCTION repeatedly until “CD” appears in the display.

You can switch the function to CD by pressing the CD button on the remote.

The indicator of CD  lights up.

2 Press PLAY MODE/DIRECTION (or PLAY MODE on the remote) in stop mode repeatedly until the mode you want appears in the display.

Select	To play
No display	The CD in original order.
SHUFFLE	The tracks on the CD in random order.
PGM	The tracks on the CD in any order that you want (see “Programming the CD tracks” on page 12).

3 Press CD (or on the remote).

Other operations

To	Do this
Stop playback	Press CD ■.
Pause	Press CD ► (or on the remote). Press again to resume playback.
Select a track	Press CD ◀◀ or ▶▶ repeatedly until you find the desired track.
Find a point in a track	During playback, press and hold CD ◀◀ or ▶▶ until you find the desired point.
Play repeatedly (Repeat Play)	Press REPEAT repeatedly during playback until "REPEAT" or "REPEAT 1" appears in the display. REPEAT: For all the tracks on the CD up to 5 times. REPEAT 1: For only the currently playing track up to 5 times. To cancel playing repeatedly, press REPEAT repeatedly until "REPEAT" and "REPEAT 1" disappear from the display.
Remove the CD	Press CD ▲.

Tip

You can start playing from the desired track in Normal Play or Program Play.

Press CD ◀◀ or ▶▶ repeatedly until the desired track appears in step 2.

Or, press the number buttons on the remote. The playback automatically starts.

To enter track number over 10 (on the remote only)

1 Press >10.

2 Enter the corresponding digits.

To enter 0, press 10/0 instead.

Example:

To enter track number 30, press >10, then 3 and 10/0.

Programming the CD tracks

— Program Play

You can make a program of up to 25 tracks on a CD in any order that you want.

1 Press FUNCTION repeatedly until “CD” appears in the display.

You can switch the function to CD by pressing the CD button on the remote.

2 Press PLAY MODE/DIRECTION (or PLAY MODE on the remote) in stop mode repeatedly until “PGM” appears in the display.

3 Press CD ◀◀ or ▶▶ repeatedly until the desired track number appears in the display.

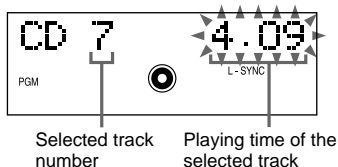

4 Press ENTER/YES on the remote.

The track is programmed.

“Step” appears, followed by the number of the track in the programmed sequence. Then the number of the last programmed track appears, followed by the total playing time of the program. If you have made a mistake, you can clear the last programmed track from the program by pressing CLEAR on the remote.

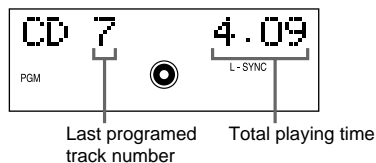

5 To program additional tracks, repeat steps 3 and 4.

6 Press CD ▶▶ (or ▶ on the remote).

To	Do this
Check the program order	Press CD ◀◀ or ▶▶ repeatedly during Program Play.
Check the total number of programmed tracks	Press DISPLAY on the remote in stop mode. The total number of programmed steps appears, and then the last programmed track number and the total playing time of the program.
Cancel Program Play	Press CD ■, then press PLAY MODE/DIRECTION (or PLAY MODE on the remote) repeatedly until “PGM” and “SHUFFLE” disappear from the display.
Add a track to the end of the program	Do steps 3 and 4 with Program Play stopped.
Erase the last programmed track	Press CLEAR on the remote in stop mode. Each time you press the button, the last programmed track is erased.
Select the desired track using the number buttons on the remote	Press number buttons instead of performing steps 3 to 5. To use number buttons, see page 11.

Tips

- The program you made remains after Program Play finishes. To play the program again, switch the function to CD, and then press CD ▶▶ (or ▶ on the remote).
- “-.-” appears when the total CD program time exceeds 100 minutes, or when you select a CD track whose number is 21 or over.

Using the CD display

Press DISPLAY on the remote repeatedly.

When a CD TEXT disc is loaded, you can check the information recorded on the disc, such as the titles.

The display changes as follows:

During normal playback

Current track number and elapsed playing time of the track → Current track number and remaining playing time of the track → Remaining playing time of the entire CD → Track title of the current track* → Clock display → BASS level → TREBLE level → Current track number and elapsed playing time of the track → ...

While the CD is stopped

Total number of tracks and total playing time → CD disc title* → Clock display → BASS level → TREBLE level → Total number of tracks and total playing time → ...

* If a CD that has no title is loaded, nothing appears. When the CD contains 21 tracks or more, CD TEXT is not displayed from track 21 on.

Labeling a CD

— Disc Memo

You can label up to 50 CDs with titles of up to 20 symbols and characters. Whenever you load a labeled CD, the title appears in the display.

Notes

- You cannot label a CD for which “TEXT” appears in the display.
- **When labeling CDs for the first time, be sure to first erase all disc titles using the procedure “Erasing a disc title” on page 14.**

1 Press CD on the remote to switch the function to CD.

If “SHUFFLE” or “PGM” appears in the display, press PLAY MODE/DIRECTION (or PLAY MODE on the remote) repeatedly until both disappear.

2 Press NAME EDIT/SELECT on the remote.

The cursor starts flashing.

3 Press NAME EDIT/SELECT on the remote repeatedly to select the desired type of character.

The display changes as follows:

Selected AB* (Upper cases) → Selected

ab* (Lower cases) → Selected 12

(Numbers) → Selected AB* (Upper cases)

→ ...

* Press number 1 repeatedly to display the following symbols.

‘ - / , . () : ! ?

In addition, when the symbols above appear in the display, press ◀◀ or ▶▶ on the remote repeatedly to display the following symbols.

& + < > _ = ” ; # \$ % @ * ` `

continued

Labeling a CD (continued)

4 Enter a character.

If you have selected uppercase or lowercase letters

- 1 Press the corresponding letter button repeatedly until the character to be entered flashes.

Or, press the button once and press **◀◀** or **▶▶** on the remote repeatedly.

- 2 Press **CURSOR→** on the remote.

The flashing character is entered and the cursor shifts to the right.

If you have selected numbers

Press the corresponding number button.

The number is entered and the cursor shifts to the right.

To enter a blank space

- 1 Press **NAME EDIT/SELECT** on the remote to select upper case or lower case letters.

- 2 Press **10/0** on the remote.

A blank space is entered and the cursor shifts to the right.

5 Repeat steps 3 and 4 to enter the rest of the name.

To change a character

Press **←CURSOR** or **CURSOR→** on the remote repeatedly until the character to be changed flashes, press **CLEAR** on the remote to erase the character, then repeat steps 3 and 4.

6 Press **ENTER/YES** on the remote to complete the labelling procedure.

To cancel labeling

Press **MENU/NO** on the remote.

Checking the disc titles

- 1 Press **MENU/NO** on the remote in stop mode.

- 2 Press **◀◀** or **▶▶** on the remote repeatedly until "Name Check ?" appears, then press **ENTER/YES** on the remote.

- 3 Press **◀◀** or **▶▶** on the remote repeatedly to select the disc titles stored in the system memory between 01 and 50.

To check the current disc title

Press **SCROLL** on the remote in stop mode.

Erasing a disc title

- 1 Press **MENU/NO** on the remote in stop mode.

- 2 Press **◀◀** or **▶▶** on the remote repeatedly until "Name Erase ?" appears, then press **ENTER/YES** on the remote.

- 3 Press **◀◀** or **▶▶** on the remote repeatedly to select the disc name to be erased.

- 4 Press **ENTER/YES** on the remote again.

"Complete !" appears.

To erase all disc titles, press **◀◀** or **▶▶** on the remote repeatedly until "All Erase ?" appears in step 2, then press **ENTER/YES** on the remote twice.

To cancel erasing

Press **MENU/NO** on the remote.

Note

The disc titles are saved in the systems memory for about a day even if you disconnect the power cord or a power failure occurs.

Loading the MD

Load an MD.

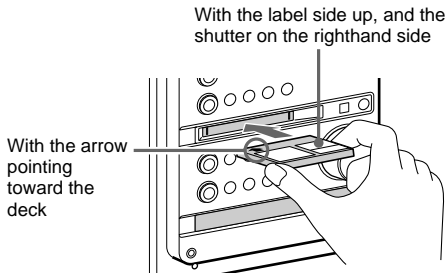

Playing the MD

— Normal Play/Shuffle Play/Repeat Play

This system lets you play MDs in different play modes.

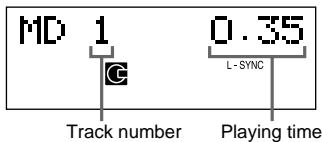

1 Press FUNCTION repeatedly until “MD” appears in the display.

You can switch the function to MD by pressing the MD button on the remote. The indicator of MD ►|| lights up.

2 Press PLAY MODE/DIRECTION (or PLAY MODE on the remote) in stop mode repeatedly until the mode you want appears in the display.

Select	To play
No display	The MD in original order.
SHUFFLE	The tracks on the MD in random order.
PGM	The tracks on the MD in any order that you want (see “Programing the MD tracks” on page 16).

3 Press MD ►|| (or ► on the remote).

Other operations

To	Do this
Stop play	Press MD ■.
Pause	Press MD ► (or on the remote). Press again to resume playback.
Select a track	Press MD ◀◀ or ▶▶ repeatedly until you find the desired track.
Find a point in a track	During playback, press and hold MD ◀◀ or ▶▶ until you find the desired point.
Play repeatedly (Repeat Play)	Press REPEAT repeatedly during playback until “REPEAT” or “REPEAT 1” appears in the display. REPEAT: For all the tracks on the MD up to 5 times. REPEAT 1: For only the currently playing track up to 5 times. To cancel playing repeatedly, press REPEAT repeatedly until “REPEAT” and “REPEAT 1” disappear from the display.
Remove the MD	Press MD ▲.

continued

Playing the MD (continued)

Before inserting an MD

When the system is on, make sure the MD icon does not appear in the display. If it does, it means an MD is already loaded. Press MD ▲ to remove the MD.

Tip

You can start playing from the desired track in Normal Play or Program Play.

Press MD ◀◀ or ▶▶ repeatedly until the desired track appears after step 2.

Or, press the number buttons on the remote. The playback automatically starts.

To enter track number over 10 (on the remote only)

1 Press >10 (Press twice to enter 100 or over).

2 Enter the corresponding digits.

To enter 0, press 10/0 instead.

Examples:

- To enter track number 30, press >10, then 3 and 10/0.
- To enter track number 108, press >10 twice, then 1, 10/0 and 8.

Programming the MD tracks

— Program Play

You can make a program of up to 25 tracks on an MD in any order that you want.

1 Press FUNCTION repeatedly until “MD” appears in the display.

You can switch the function to MD by pressing the MD button on the remote.

2 Press PLAY MODE/DIRECTION (or PLAY MODE on the remote) in stop mode repeatedly until “PGM” appears in the display.

3 Press MD ◀◀ or ▶▶ repeatedly until the desired track number appears in the display.

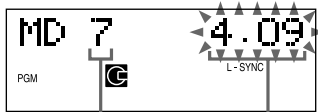

Selected track number

Playing time of the selected track

4 Press ENTER/YES on the remote.

The track is programmed.

“Step” appears, followed by the number of the track in the programmed sequence. Then the number of the last programmed track appears, followed by the total playing time of the program. If you have made a mistake, you can clear the last programmed track from the program by pressing CLEAR on the remote.

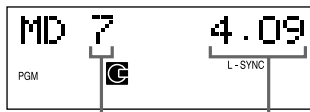

Last programmed track number

Total playing time

5 To program additional tracks, repeat steps 3 and 4.

6 Press MD ►II (or ► on the remote).

To	Do this
Check the program order	Press MD ◀◀ or ▶▶ repeatedly during Program Play.
Check the total number of programmed tracks	Press DISPLAY on the remote in stop mode. The last programmed track number appears, followed by the total number of programmed steps.
Cancel Program Play	Press MD ■, then press PLAY MODE/DIRECTION (or PLAY MODE on the remote) repeatedly until "PGM" and "SHUFFLE" disappear from the display.
Add a track to the end of the program	Do steps 3 and 4 with program play stopped.
Erase the last programmed track	Press CLEAR on the remote in stop mode. Each time you press the button, the last programmed track is erased.
Select the desired track using the number buttons on the remote	Press number buttons instead of performing steps 3 to 5. To use number buttons, see page 16.

Tips

- The program you made remains after Program Play finishes. To play the same program again, switch the function to MD, and press MD ►II (or ► on the remote).
- "----" appears when the total MD program time exceeds 1000 minutes.

Using the MD display

Press DISPLAY on the remote repeatedly.

The display changes as follows:

During normal playback

Current track number and elapsed playing time of the track → Current track number and remaining playing time of the track → Remaining playing time of the entire MD → MD track title*¹ → Clock display → BASS level → TREBLE level → Current track number and elapsed playing time of the track → ...

While the MD is stopped

Total number of tracks and total playing time*² → Remaining recordable time (only for a recordable MD) → MD disc title*¹ → Clock display → BASS level → TREBLE level → Total number of tracks and total playing time*² → ...

*¹ Nothing appears when no disc or track title is labeled.

*² "----" appears when the total MD program time exceeds 1000 minutes.

Tip

You can check a track title at any time during play. If you press SCROLL on the remote, a track title appears scrolling in the display.

Press SCROLL on the remote at any point during the scroll display to stop the scrolling. Press SCROLL on the remote again to restart the scrolling.

Before you start recording

MDs (Mini Disc) let you digitally record and play music with high quality sound. Another feature of MDs is track marking. The track marking feature lets you quickly locate a specific point or easily edit the recorded tracks. However, depending on the source you record, the recording method and the way the track numbers are recorded differ.

When the source you record from is:

- This system's CD player
 - The MD deck performs digital recording.*¹
 - Track numbers are automatically marked as on the original CD.
- Other digital components connected to the DIGITAL OPTICAL IN jack
 - The MD deck performs digital recording.*¹
 - Track numbers are marked differently depending on the source you record.
- This system's tuner and other components connected to the ANALOG IN jack (e.g., a VCR)
 - The MD deck performs analog recording.
 - A track number is marked at the beginning of a recording, but when you turn on the Level-Synchro Recording function (see page 23), track numbers are automatically marked in sync with the level of the input signal.

*¹ For details on the limitations of digital recording, see page 48.

When you use a partially recorded MD

Recording starts after the recorded tracks.

Note on MD track numbers

On an MD, the track numbers (track sequence), track start and end point information, etc., are recorded in the TOC*² area independent of the sound information. You can edit recorded tracks quickly by modifying the TOC information.

*² TOC: Table Of Contents

After recording

Press MD ▲ to remove the MD or press I/⏻ (power) to turn off the system.

“TOC” or “STANDBY” lights up or starts flashing. The TOC is updated and recording is completed.

Before pulling out the power cord MD recording is completed when the MD Table of Contents (TOC) is updated. The TOC is updated when you eject the MD or press I/⏻ to turn off the system. Do not pull out the power cord before updating the TOC (while “TOC” or “STANDBY” is lit) or while updating the TOC (while “TOC” or “STANDBY” is flashing) to ensure a complete recording.

Protecting a recorded MD

To protect a recorded MD, slide the tab on the side of the MD to open the slot. In this position, the MD cannot be recorded. To record on the MD, slide the tab to close the slot.

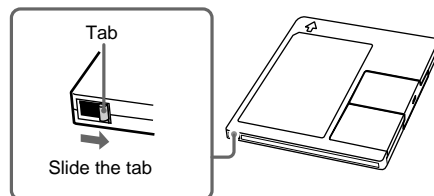

Recording a CD on an MD

— CD-MD Synchro Recording

- 1 Load a recordable MD.
- 2 Load a CD on the disc tray.
- 3 Press **SYNCHRO REC** repeatedly until **“CD-MD SYNC”** appears in the display.
- 4 Press **ENTER/START**.
“Press START” flashes in the display.
The MD deck stands by for recording and the CD player pauses for play.
- 5 Verify that **“Press START”** flashes in the display. Then press **ENTER/START**.
Recording starts.

To stop recording
Press **CD ■** or **MD ■**.

Tips

- You can record only your favorite CD tracks with CD Program Play. After step 2, follow the same procedures as from step 1 to 5 in CD Program Play (see page 12). Then go to step 3.
- Depending on the disc, CD TEXT information may also be recorded (except when you record on an MD and a tape at the same time). If “TEXT” flashes during recording, see page 26.

Note

If the MD becomes full during recording, the CD player and the MD deck stop automatically.

Recording a CD on an MD
with high speed

— CD-MD High-Speed Synchro Recording

You can make a digital recording of a CD on an MD at twice the speed of normal CD-MD Synchro Recording.

In step 3 of “Recording a CD on an MD”, press SYNCHRO REC repeatedly until “HISPEED SYNC” appears in the display.

In step 4, “×2” appears in the display.

During high speed recording, you cannot listen to the playback sound.

If “Retry” flashes in the display after you press **ENTER/START** in step 5

A reading failure has occurred, and the MD deck is trying to read the data again.

- If the retry was successful, the MD deck continues with CD-MD High-Speed Synchro Recording.
- If the condition of the loaded CD or the system is poor, and retry fails, CD-MD High-Speed Synchro Recording is disabled. In this case, “×1” flashes in the display and the MD deck automatically starts recording in normal CD-MD Synchro Recording. Note that monitoring of the recorded signal is not possible when this occurs.

continued

Recording a CD on an MD (continued)

Notes

- You cannot pause recording during CD-MD High-Speed Synchro Recording.
- If the play mode is set to the Repeat or Shuffle Play, it automatically switches to normal play at step 3 of “Recording a CD on an MD”.
- The following items are either inoperative or cannot be used during CD-MD High-Speed Synchro Recording:
 - Auto Cut function.
 - Recorded signal monitoring.

Recording a CD on an MD and a tape at the same time

Load the CD you want to record. Then load a blank tape and recordable MD. Press SYNCHRO REC repeatedly until “DUAL SYNC” appears, and then perform step 4 through 6 of “Recording a CD on a tape” (see page 40).

Recording a tape on an MD

— TAPE-MD Synchro Recording

You can make an analog recording of a tape on an MD.

You can use Type I (normal) tape.

- 1 Load a recordable MD.
- 2 Load a tape.
- 3 Press **SYNCHRO REC** repeatedly until “TAPE-MD SYNC” appears in the display.
- 4 Press **ENTER/START**.

The MD deck stands by for recording and the tape deck pauses for play.

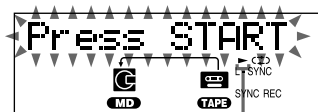

Tape playback side

▶ appears for the front side, and ◀ for the reverse side. To play the side not indicated, press **TAP** ■ and remove the tape to reverse the tape side, then perform steps 3 and 4 again.

- 5 Verify that “Press START” flashes in the display. Then press **ENTER/START**. Recording starts.

To stop recording

Press **TAP** ■ or **MD** ■.

Note

If the MD becomes full during recording, the tape deck and the MD deck stop automatically.

Recording on an MD manually

— Manual Recording

With manual recording, you can record just the portions you like from a CD, or start recording from the middle of the tape. You can also record a radio program.

- 1 **Load a recordable MD.**
- 2 **Press FUNCTION repeatedly to select the desired source to record.**
- 3 **Press ● MD.**
The MD deck stands by for recording.
- 4 **Press MD ►|| and start playing the desired source to record.**

To stop recording

Press MD ■.

Tip

You can check the remaining recordable time on the MD during recording by pressing DISPLAY on the remote repeatedly.

Starting recording with 6 seconds of prestored audio data

— Time Machine Recording

When recording from an FM or satellite broadcast, the first few seconds of material are often lost due to the time it takes you to ascertain the contents and press the record button. To prevent the loss of this material, the Time Machine Recording feature constantly stores the most recent audio data in a buffer memory. This lets you record the sound from 6 seconds before starting recording, as shown in the illustration below:

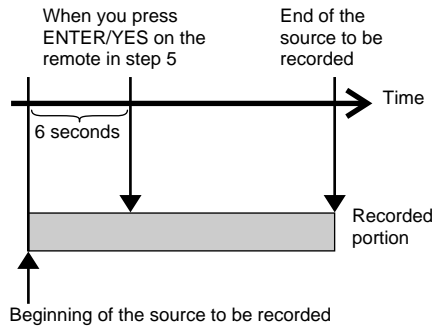

- 1 **Load a recordable MD.**
- 2 **Press FUNCTION repeatedly to select the desired source to record.**
- 3 **Press ● MD.**
The MD deck stands by for recording.
- 4 **Start playing the desired source to record.**
- 5 **Press ENTER/YES on the remote at the desired point to start recording.**

continued

Starting recording with 6 seconds of prestored audio data (continued)

To stop Time Machine Recording
Press MD ■.

Note

The MD deck starts storing audio data when the deck stands by for recording in step 3 and you start playing the source. If less than 6 seconds have passed when you press ENTER/YES on the remote, Time Machine Recording starts with less than 6 seconds of audio data.

Recording tips

— Recording for long times/Marking track numbers/Smart space/Adjusting the recording level

Recording for long times

In addition to normal stereo recording, this system has two long time modes: LP2 and LP4. When recording in LP2 mode, you can record 2 times the normal recordable time, and in LP4 mode, you can record 4 times the normal recordable time. In addition, the recordable time for monaural recording is approximately double the stereo recording time. LP4 Stereo mode (4× long time recording mode) achieves a long stereo recording time by use of a special compression system. When placing emphasis on sound quality, Stereo recording or LP2 Stereo recording (2× long time recording mode) is recommended.

1 Before recording (CD-MD Synchro Recording, etc.), press REC MODE repeatedly to select the recording mode you want.

The display changes as follows:
STEREO REC → LP2 REC → LP4 REC
→ MONO REC (Monaural) → STEREO REC → ...

2 Start recording.

Tip

The selected recording mode is kept even after recording has finished, so be sure to check the recording mode before recording.

Notes

- MDs recorded in MDLP (LP2 or LP4) mode cannot be played back on a system that does not support MDLP mode. In addition, you cannot perform S.F Edit, etc., for MDs recorded in MDLP mode.
- Even if you press REC MODE during recording or recording pause, you cannot change the recording mode.
- Even if you press REC MODE repeatedly to select MONO, the monitor signal during recording does not become monaural.

To add "LP:" at the beginning of a track name during MDLP recording "LP:" appears when you try to play the track on a system that does not support MDLP mode. This convenient function lets you know at a glance that the track cannot be played back. The factory setting is "On".

- 1** Press FUNCTION repeatedly until "MD" appears in the display.
- 2** Press MENU/NO on the remote repeatedly until "Setup Menu" appears.
- 3** Press ◀◀ or ▶▶ on the remote until "LP Stamp On" (or "LP Stamp Off") appears, then press ENTER/YES on the remote.

4 Press **◀◀** or **▶▶** on the remote to select the setting, then press **ENTER/YES** on the remote.

To	Select
Add "LP"	LP Stamp On (factory setting)
Cancel adding "LP"	LP Stamp Off

5 Press **MENU/NO** on the remote.

Notes

- The recorded "LP:" is a stamp which appears to indicate that the track cannot be played back when you try to play the track on system that does not support MDLP mode. It does not appear for systems that support MDLP mode.
- When set to "On", "LP:" is recorded as the track name, so the number of characters that can be input to an MD is reduced. In addition, when you copy a track name with "LP:" added, "LP:" is automatically added to the copied track name. If you divide an "LP:" track using the Divide function, "LP:" is also added to the latter track.

Marking track numbers

• Automatically during recording

Track numbers are automatically marked as on the original source during recording from this system's CD player. Use the Level-Synchro Recording function to automatically mark track numbers during recording from this system's tuner or components connected to the ANALOG IN jack.

• At any point during recording

You can mark track numbers during recording of any source (see page 24).

• After recording

Use the Divide Function (see page 31).

Marking track numbers automatically during recording — Level-Synchro Recording

The Level-Synchro Recording function is factory set to on, so the track numbers are automatically marked. If "L-SYNC" does not appear during recording, turn on the Level-Synchro Recording as follows. Track numbers are automatically marked when the input signal is continuously below a certain level for more than 2 seconds and then exceeds that level.

Notes

- You cannot mark track numbers automatically if the sound source to be recorded is noisy (e.g., tapes or radio programs).
- Only one track number might be assigned when the same single track of the same CD is recorded repeatedly.

1 Press **FUNCTION** repeatedly until "MD" appears in the display.

2 Press **MENU/NO** on the remote repeatedly until "Setup Menu" appears in the display.

3 Press **◀◀** or **▶▶** on the remote repeatedly until "T.Mark Off" (or "T.Mark LSync") appears, then press **ENTER/YES** on the remote.

4 Press **◀◀** or **▶▶** on the remote repeatedly to select the setting, then press **ENTER/YES** on the remote.

To	Select
Turn on the Level Synchro Recording function	T.Mark LSync (factory setting)
Turn off the Level Synchro Recording function	T.Mark Off

When you set the Level Synchro Recording function, "L-SYNC" lights up.

5 Press **MENU/NO** on the remote.

To continue and record, follow the procedures described on the various recording pages.

To change the trigger level for Level Synchro Recording

Perform the following procedure to change the signal level that triggers Level Synchro Recording.

1 Press **FUNCTION** repeatedly to switch the function to MD.

2 Press **MENU/NO** on the remote repeatedly until "Setup Menu" appears.

3 Press **◀◀** or **▶▶** for the MD until "LS(T)" appears, then press **ENTER/YES** on the remote.

4 Press **◀◀** or **▶▶** for the MD to select the level, then press **ENTER/YES** on the remote.

You can set the level at any value between -72 dB and 0 dB, in 2 dB steps.

5 Press **MENU/NO** on the remote.

Recording tips (continued)

Marking track numbers at a specific point during recording

— Track Mark

You can mark track numbers at any time during manual recording, regardless of the type of sound source.

Press ● MD during manual recording at the point you want to add a track mark.

The tracks following the added one are renumbered.

Making a space between tracks 3 seconds long

— Smart Space

Smart Space: Lets you make the blank spaces between tracks 3 seconds long automatically while recording. If the Smart Space function is on and there is no sound input for about 3 seconds or more (but less than 30 seconds) while recording, the MD deck replaces this silence with a blank of about 3 seconds and continues recording.

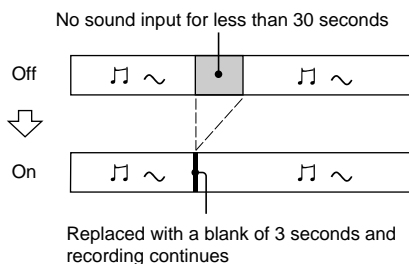

Auto Cut: When the Smart Space function is on, if there is no sound input for 30 seconds or more, the MD deck replaces this silence with a blank of about 3 seconds and enters recording pause.

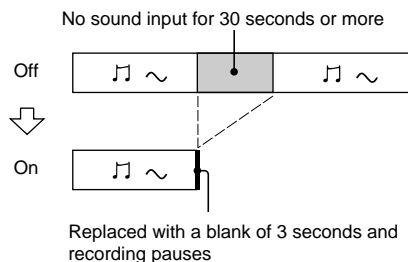

- 1 Press **FUNCTION** repeatedly until “MD” appears in the display.
- 2 Press **MENU/NO** on the remote repeatedly until “Setup Menu” appears in the display.
- 3 Press **◀◀** or **▶▶** on the remote repeatedly until “S.Space Off” (or “S.Space On”) appears, then press **ENTER/YES** on the remote.
- 4 Press **◀◀** or **▶▶** on the remote repeatedly to select the setting, then press **ENTER/YES** on the remote.

To	Select
Turn on the Smart Space function	S.Space On (factory setting)
Turn off the Smart Space function	S.Space Off

- 5 Press **MENU/NO** on the remote. To continue and record, follow the procedures described on the various recording pages.

Tip

To restart the recording when “Auto Cut” appears in the display, press **▶** on the remote.

Adjusting the recording level

When recording on an MD, you can adjust the recording level to the desired volume. You can adjust the recording level not only when making an analog recording, but also when making a digital recording from a CD, etc.

- 1 Prepare the desired sound source to record and start play.**
- 2 Confirm that the MD deck is in recording standby.**
If not, press **●** MD.
- 3 Press MENU/NO on the remote repeatedly until “Setup Menu” appears in the display.**
- 4 Press **◀◀** or **▶▶** on the remote repeatedly until “LevelAdjust?” appears, then press ENTER/YES on the remote.**
- 5 Press **◀◀** or **▶▶** on the remote to adjust the recording level.**
Make sure that “OVER” does not appear in the display at the loudest portion.
- 6 Press ENTER/YES on the remote.**
- 7 Press MENU/NO on the remote.**
- 8 Press **■** on the remote.**
To continue and record, follow the procedures described on the various recording pages.

Tips

- You can also adjust the recording level during recording.
- Once adjusted, the recording level is maintained until you adjust it again.

Before you start editing

Before editing

You can edit an MD only when:

- The MD is recordable.
- The MD play mode is normal play.

Check the following, before editing.

1 Check the tab of the MD to be edited.

If the MD is record protected, “C11” and “Protected” appear alternately and the MD cannot be edited.

Slide the tab to close the slot.

2 Press **PLAY MODE/DIRECTION** (or **PLAY MODE** on the remote) in stop mode repeatedly until both “PGM” and “SHUFFLE” disappear.

You can edit the MD only in normal play mode. You cannot edit the MD in Shuffle or Program Play.

To cancel the last edit (page 33)

Use undo function to cancel the last edit and restore the contents of the MD to the condition before the edit.

To quit while editing

Press MENU/NO on the remote.

After editing

Press MD ▲ to remove the MD or press I/⏻ (power) to turn off the system.

“TOC” or “STANDBY” lights up or starts flashing. The TOC is updated and editing is completed.

Before pulling out the power cord

MD editing is completed when the MD Table of Contents (TOC) is updated. The TOC is updated when you eject the MD or press I/⏻ to turn off the system. Do not pull out the power cord before updating the TOC (while “TOC” or “STANDBY” is lit) or while updating the TOC (while “TOC” or “STANDBY” is flashing) to ensure a complete editing.

Labeling an MD

— Name Function

You can create titles for your recorded MDs and tracks as follows.

During recording

If “TEXT” lights up or flashes during recording, you can record the CD TEXT information onto the MD as follows:

- Automatically during recording
If you record on an unrecorded or completely erased (see page 29) MD when “TEXT” is lit, the CD TEXT information is automatically recorded.
- Manually during recording
When “TEXT” flashes, press NAME EDIT/SELECT on the remote, and then press ENTER/YES on the remote to record the title of the current track.

Notes

- Depending on the disc, the CD TEXT information may not be recorded automatically.
- However, the CD disc title is not recorded when recording a CD on an MD and a tape at the same time.

After recording

Use Name Function on page 26. You can input a total of approximately 1700 characters for the disc title and track titles on a single MD.

1 Press MD on the remote to switch the function to MD.

To label a track, press **◀◀** or **▶▶** on the remote repeatedly until the desired track number appears.

2 Press NAME EDIT/SELECT on the remote.

The cursor starts flashing.

3 Press NAME EDIT/SELECT on the remote repeatedly to select the desired type of character.

The display changes as follows:

Selected AB* (Upper cases) → Selected ab* (Lower cases) → Selected 12 (Numbers) → Selected AB* (Upper cases) → ...

* Press number 1 repeatedly to display the following symbols.

' - / , . () : ! ?

In addition, when the symbols above appear in the display, press **◀◀** or **▶▶** on the remote repeatedly to display the following symbols.

& + < > _ = " ; # \$ % @ * `

4 Verify that a cursor flashes in the display. Then enter a character.

If you have selected uppercase or lowercase letters

1 Press the corresponding letter button repeatedly until the character to be entered flashes.

Or, press the button once and press **◀◀** or **▶▶** on the remote repeatedly.

2 Press **CURSOR→** on the remote.

The flashing character is entered and the cursor shifts to the right.

If you have selected numbers

Press the corresponding number button.

The number is entered and the cursor shifts to the right.

To enter a blank space

1 Press **NAME EDIT/SELECT** on the remote to select upper case or lower case letters.

2 Press **10/0** on the remote.

A blank space is entered and the cursor shifts to the right.

5 Repeat steps 3 and 4 to enter the rest of the name.

To change a character

Press **←CURSOR** or **CURSOR→** on the remote repeatedly until the character to be changed flashes, press **CLEAR** on the remote to erase the character, then repeat steps 3 and 4.

6 Press ENTER/YES on the remote to complete the labeling procedure.

The titles you labeled appear sequentially, and then the original display appears.

Note

You can label a track title during play. The playback repeats until you finish labeling.

continued

Labeling an MD (continued)

Copying a disc or track title

You can copy a labeled disc or track title to use it as a title of another track or the disc title within a disc.

- 1 Press **MENU/NO** on the remote in stop mode.
- 2 Press **◀◀** or **▶▶** on the remote repeatedly until “Name ?” appears, then press **ENTER/YES** on the remote.
- 3 Press **◀◀** or **▶▶** on the remote repeatedly until “Nm Copy ?” appears, then press **ENTER/YES** on the remote.
- 4 Press **◀◀** or **▶▶** on the remote repeatedly to select “Disc” (when copying the disc title) or the track number with the title you want to copy, then press **ENTER/YES** on the remote.
- 5 Press **◀◀** or **▶▶** on the remote repeatedly to select the copy destination track number or “Disc” (when copying as the disc title), then press **ENTER/YES** on the remote.

When “Overwrite ??” appears

The copy destination already has a disc or track title. To continue and copy the title, press **ENTER/YES** on the remote.

Checking the titles

To check the disc titles, press **SCROLL** on the remote in stop mode. To check the track title, press **SCROLL** on the remote during play. The title appears scrolling in the display. To stop scrolling, press **SCROLL** on the remote. Press the button again to resume scrolling.

Erasing the titles

- 1 Press **MENU/NO** on the remote in stop mode.
- 2 Press **◀◀** or **▶▶** on the remote repeatedly until “Name ?” appears, then press **ENTER/YES** on the remote.
- 3 Press **◀◀** or **▶▶** on the remote repeatedly until “Nm Erase?” appears, then press **ENTER/YES** on the remote.
- 4 Press **◀◀** or **▶▶** on the remote repeatedly until the desired track number or “Disc” when you want to erase the disc title to erase appears, then press **ENTER/YES** on the remote.

To erase all the titles

Press **◀◀** or **▶▶** on the remote repeatedly until “Nm All Ers?” appears in step 3, then press **ENTER/YES** on the remote twice.

Erasing recordings

— Erase Function

The MD deck lets you erase unwanted tracks quickly and easily.

The three options for erasing recordings are:

- Erasing a single track (Track Erase Function)
- Erasing all tracks (All Erase Function)
- Erasing a portion of a track (A-B Erase Function)

Erasing a single track — Track Erase Function

You can erase a track simply by selecting its track number. When you erase a track, the total number of tracks on the MD decreases by one and all the tracks following the erased one are renumbered.

Example: Erasing track 2.

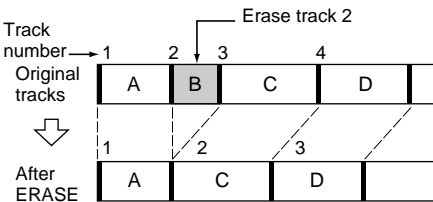

- 1 Press MD on the remote to switch the function to MD.
- 2 Press MENU/NO on the remote to display “Edit Menu”.
- 3 Press I◀◀ or ▶▶I on the remote repeatedly until “Tr Erase?” appears, then press ENTER/YES on the remote.

4 Press I◀◀ or ▶▶I on the remote repeatedly until the desired track number appears.

5 Press ENTER/YES on the remote. “Complete !” appears.

Note

“Erase???” appears when the track was recorded or edited on another deck and then protected. To erase the track, press ENTER/YES on the remote while “Erase???” appears.

Erasing all tracks — All Erase Function

You can erase the disc title, all recorded tracks and their titles at once.

- 1 Press MD on the remote to switch the function to MD.
- 2 Press MENU/NO on the remote to display “Edit Menu”.
- 3 Press I◀◀ or ▶▶I on the remote repeatedly until “All Erase ?” appears, then press ENTER/YES on the remote. “All Erase ???” appears.
- 4 Press ENTER/YES on the remote again. “Complete !” appears.

continued

Erasing recordings (continued)

Erasing a portion of a track — A-B Erase Function

You can specify a portion within a track and erase the portion with ease. You can shift the desired portion by frame*, minute or second intervals.

* 1 frame is 1/86 second.

Example: Erasing a portion of track 2.

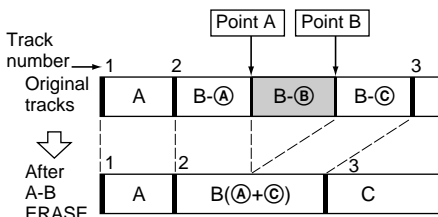

- 1 Press MD on the remote to switch the function to MD.
- 2 Press MENU/NO on the remote to display "Edit Menu."
- 3 Press ◀◀ or ▶▶ on the remote repeatedly until "A-B Erase ?" appears, then press ENTER/YES on the remote.
- 4 Press ◀◀ or ▶▶ on the remote repeatedly to select the track you want to erase a portion of it, then press ENTER/YES on the remote.
"—Rehearsal—" and "Point A ok?" appear alternately while the deck plays the selected track from the beginning to point A.
- 5 While monitoring the sound, press ◀◀ or ▶▶ on the remote repeatedly to find the starting point of the portion to be erased (point A).

You can shift the starting point by 1/86 second (1 frame) intervals*.

To shift the point by second or minute intervals, press ◀◀ or ▶▶ on the remote so that second or minute flashes, then press ◀◀ or ▶▶ on the remote.

* You can shift the starting point by 2-frame intervals (in Monaural mode and LP2 Stereo mode) or by 4-frame intervals (in LP4 Stereo mode).

- 6 Repeat step 5 until point A is played correctly.
- 7 Press ENTER/YES on the remote if point A is correct.
"Point B set" appears and playback for setting the ending point of the portion to be erased (point B) starts.
- 8 Continue playback until the deck reaches point B, then press ENTER/YES on the remote.
"A-B Ers" and "Point B ok?" appear alternately and the deck repeats a portion of the few seconds before point A and after point B successively.
- 9 Press ◀◀ or ▶▶ on the remote repeatedly to find point B.
The procedure is the same as step 5.
- 10 Press ENTER/YES on the remote if point B is correct.
"Complete !" appears.

Moving recorded tracks

— Move Function

You can use this function to change the order of any track on the disc. When you move tracks, the tracks are automatically renumbered.

Example: Moving track 3 to position 2.

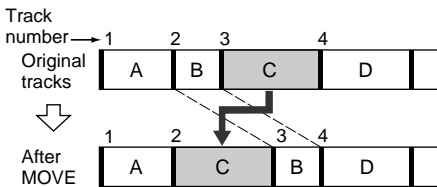

- 1 Press MD on the remote to switch the function to MD.
- 2 Press MENU/NO on the remote to display “Edit Menu.”
- 3 Press **◀** or **▶** on the remote repeatedly until “Move ?” appears, then press ENTER/YES on the remote.
- 4 Press **◀** or **▶** on the remote repeatedly until the desired track number to move appears, then press ENTER/YES on the remote.
- 5 Press **◀** or **▶** on the remote repeatedly until the new track position appears.

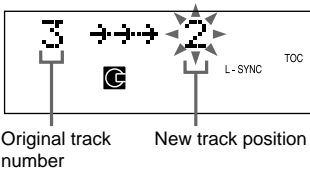

- 6 Press ENTER/YES on the remote.
“Complete !” appears.

Dividing recorded tracks

— Divide Function

You can use this function to mark track numbers after recording. The total number of tracks increases by one and all the tracks following the divided ones are renumbered.

Example: Dividing track 2 into two tracks.

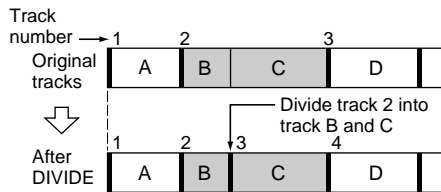

- 1 Press MD on the remote to switch the function to MD.
- 2 Press MENU/NO on the remote to display “Edit Menu.”
- 3 Press **◀** or **▶** on the remote repeatedly until “Divide ?” appears, then press ENTER/YES on the remote.
- 4 Press **◀** or **▶** on the remote repeatedly until the desired track number to divide appears. Then, while listening to rehearsal play, press ENTER/YES on the remote at the point where you want to divide the track.
“—Rehearsal—” appears and the portion to be divided is played repeatedly.

continued

Dividing recorded tracks (continued)

- 5 While monitoring the sound, press **I◀◀** or **▶▶I** on the remote repeatedly to adjust the point to be divided.

You can shift the point by 1/86 second (1 frame) intervals*.

To shift the point by second or minute intervals, press **◀◀** or **▶▶** on the remote so that second or minute flashes, then press **I◀◀** or **▶▶I** on the remote.

* You can shift the starting point by 2-frame intervals (in Monaural mode and LP2 Stereo mode) or by 4-frame intervals (in LP4 Stereo mode).

- 6 Press **ENTER/YES** on the remote.

“Complete !” appears.

Note

If you divide a labeled track (see page 26) into two tracks, only the first track retains the track title.

Example:



Combining recorded tracks

— Combine Function

You can use this function to combine 2 tracks into a single track. The total number of tracks decreases by one and all tracks following the combined ones are renumbered.

You can also use this function to erase unnecessary track numbers.

Example: Combining track 3 to track 1.

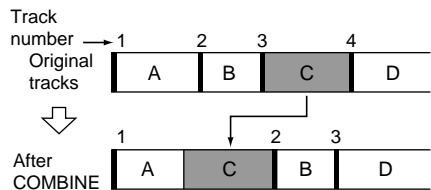

Example: Combining track 1 to track 4.

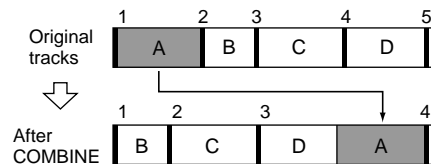

- 1 Press **MD** on the remote to switch the function to MD.
- 2 Press **MENU/NO** on the remote to display “Edit Menu.”
- 3 Press **I◀◀** or **▶▶I** on the remote repeatedly until “Combine ?” appears, then press **ENTER/YES** on the remote.

- 4 Press **◀◀** or **▶▶** on the remote repeatedly until the first track number of the two to be combined appears, then press **ENTER/YES** on the remote. For example, to combine track 1 to 4, select 4.

- 5 Press **◀◀** or **▶▶** on the remote repeatedly until the second track number of the two to be combined appears.

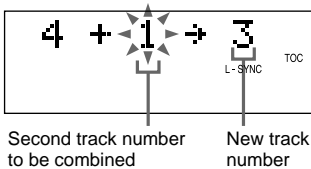

- 6 Press **ENTER/YES** on the remote. “Complete !” appears.

Notes

- Tracks recorded in different recording modes (stereo, LP2, LP4 or MONO) cannot be combined.
- If both of the combined tracks have track titles, the title of the second track is erased.

Undoing the last edit

— Undo Function

You can use this function to cancel the last edit and restore the contents of the MD to the condition before the edit.

Note, however, that you cannot undo an edit if you do any of the following after the edit:

- Do another edit.
- Press the **●** MD or **ENTER/START** button.
- Update the TOC by turning off the system or ejecting the MD.
- Disconnect the power cord.

- 1 Press **MENU/NO** on the remote in stop mode to display “Edit Menu.”

- 2 Press **◀◀** or **▶▶** on the remote repeatedly until “Undo ?” appears in the display.

“Undo ?” does not appear, when there is no editing function that can be canceled.

- 3 Press **ENTER/YES** on the remote.

A message appears, depending on the last edit.

- 4 Press **ENTER/YES** on the remote again. “Complete !” appears.

Changing the recording level after recording

— S.F Edit

You can change the volume of the recorded tracks using S.F (Scale Factor) Edit. The original track is recorded over at the new recording level. When changing the recording level, you can select Fade-in Recording to gradually increase the signal level at the start of recording, or Fade-out Recording to gradually decrease the signal level at the end of the recording.

Changing the overall recording level of a track

- 1 Press **MD** on the remote to switch the function to **MD**.
- 2 Press **PLAY MODE** on the remote repeatedly until both “**PGM**” and “**SHUFFLE**” disappear.
- 3 Press **MENU/NO** on the remote to display “**Edit Menu.**”
- 4 Press **◀◀** or **▶▶** on the remote repeatedly until “**S.F Edit ?**” appears in the display, then press **ENTER/YES** on the remote.
- 5 Press **◀◀** or **▶▶** on the remote repeatedly until “**Tr Level?**” appears in the display, then press **ENTER/YES** on the remote.

- 6 Press **◀◀** or **▶▶** on the remote repeatedly to select the track number you want to change the recording level of, then press **ENTER/YES** on the remote.

“Level 0dB” appears.

- 7 While monitoring the sound, press **◀◀** or **▶▶** on the remote repeatedly to change the recording level.

The recording level can be adjusted from -12 dB to +12 dB in 2 dB increments.

Adjust the recording level so as not to light up “**OVER**” at the strongest sound.

- 8 Press **ENTER/YES** on the remote.

“S.F Edit OK?” appears.

- 9 Press **ENTER/YES** on the remote.

“S.F Edit: **%” appears while the track is being recorded. An amount of time that is roughly equal to or longer than the playback time of the track is required when recording over the track. When the recording finishes, “**Complete !**” appears for a few seconds.

To cancel the operation

Press **MENU/NO** on the remote during step 2 through 8. If you press **ENTER/YES** on the remote in step 9 and start recording, you cannot interrupt the operation.

Fade-in and Fade-out Recording

- 1 Press **MD** on the remote to switch the function to **MD**.
- 2 Press **PLAY MODE** on the remote repeatedly until both “**PGM**” and “**SHUFFLE**” disappear.
- 3 Press **MENU/NO** on the remote to display “**Edit Menu.**”

4 Press \lll or \ggg on the remote repeatedly until “S.F Edit ?” appears in the display, then press ENTER/YES on the remote.

5 Press \lll or \ggg on the remote repeatedly until “Fade In?” or “Fade Out?” appears in the display, then press ENTER/YES on the remote.

6 Press \lll or \ggg on the remote repeatedly to select the track number you want to Fade-in or Fade-out, then press ENTER/YES on the remote.
“Time 5.0s” appears.

7 While monitoring the sound, press \lll or \ggg on the remote repeatedly to change the Fade-in, or Fade-out recording time.

The system plays the portion that will be recorded over using the Fade-in or Fade-out Recording. You can set the time at any value between 1.0 second and 15.0 seconds in 0.1-second increments. You cannot set the time longer than the track.

8 Press ENTER/YES on the remote.
“S.F Edit OK?” appears.

9 Press ENTER/YES on the remote.
“S.F Edit: **%” appears while the track is being recorded. When the recording finishes, “Complete !” appears for a few seconds.

To cancel the operation

Press MENU/NO on the remote during step 2 through 8. After recording starts in step 9, you cannot interrupt the operation.

Notes

- You cannot use the S.F Edit Function for tracks recorded in MDLP mode.
- You cannot undo the S.F Edit Function even if you use the Undo Function.
- Do not disconnect the power cord or move the system while recording is in progress. This may damage the recording data, preventing recording from being performed properly.
- Do not use an MD that is damaged or dirty, this may prevent data from being recorded properly.
- Repeatedly changing the recording level results in poor sound quality.
- The recording level will not return to the exact original level once the recording level has been changed even if it is returned to the original level.
- While the timer is activated, you cannot change the recording level.
- You cannot return to the original condition after changing the recording level.

Presetting radio stations

The system can store a total of 30 preset stations (20 for FM and 10 for AM).

- 1 Press **BAND** to select **FM** or **AM**.
- 2 Press **TUNING MODE** repeatedly until **"AUTO"** appears in the display.
- 3 Press **TUNING +** or **-**.

The frequency changes as the system scans for a station. Scanning stops automatically when a station is tuned in. At that time, **"TUNED"** and **"STEREO"** (for stereo program only) appear.

- 4 Press **MENU/NO** on the remote.

A preset number flashes.

- 5 Press **◀◀** or **▶▶** on the remote repeatedly until **"Memory?"** appears, then press **ENTER/YES** on the remote.

A preset number appears in the display. The stations are stored from preset number 1.



Preset number

- 6 Press **ENTER/YES** on the remote.
"Complete !" appears, and then the station is stored.
- 7 Repeat steps 1 through 6 to preset other stations.

To stop scanning
Press **TUNING MODE**.

To tune in a weak station
In step 3, press **TUNING MODE** repeatedly until **"AUTO"** and **"PRESET"** disappear from the display, then press **TUNING +** or **-** repeatedly to tune in the station.

To change the preset number
Start over from step 1.

To change the AM tuning interval (not applicable on the European model)

The AM tuning interval is factory-preset to 9 kHz (or 10 kHz for some areas). To switch the AM tuning interval, tune in any AM station first, then turn off the system. Pressing and holding down **REPEAT**, turn the system back on. When you change the interval, all the AM preset stations are erased. To change back to the original interval, repeat the same procedure.

Note

You cannot change the AM tuning interval in the Power saving mode.

Tip

The preset stations are saved in the system's memory for about a day even if you disconnect the power cord or a power failure occurs.

Listening to the radio

— Preset Tuning

Presetting radio stations in the system's memory in advance make it easy to tune in those stations later (see "Presetting radio stations" on page 36).

- 1 Press BAND to select FM or AM.**
- 2 Press TUNING MODE repeatedly until "PRESET" appears in the display.**
- 3 Press TUNING + or – repeatedly to display the preset number of the desired station.**

The preset number scrolls in the display, followed by the frequency (or station name* or RDS station name**).

* The station name appears only if you have labeled the station (see page 38).

** European model only

To turn off the radio

Press I/⏻.

To enter preset number over 10 (on the remote only)

- 1 Press >10.**
- 2 Enter the corresponding digits.**

To enter 0, press 10/0 instead.

Example:

To enter preset number 20, press >10, then 2 and 10/0.

To tune in a non-preset radio station

- In step 2, press TUNING MODE repeatedly until "AUTO" and "PRESET" disappear from the display, then press TUNING + or – repeatedly to tune in the desired station (Manual Tuning).
- In step 2, press TUNING MODE repeatedly until "AUTO" appears in the display, then press TUNING + or –. The frequency indication changes and the scanning stops when the system tunes in a station (Automatic Tuning).

To cancel Automatic Tuning

Press TUNING MODE.

Tips

- If there is static during an FM broadcast, press STEREO/MONO until "MONO" appears in the display. The broadcast will no longer be in stereo, but the reception will improve.
- To improve the reception, adjust the supplied antennas or connect an external antenna.

Labeling the preset stations

— Station Name

You can label each preset station with up to 12 characters (Station Name).

- 1 Tune the desired station you want to label (see page 37).**
- 2 Follow the same procedures as from step 2 to 6 on “Labeling a CD” (see page 13).**

To check the preset number and frequency

The station name appears when you tuned the labeled station.

To check the preset number and frequency, press DISPLAY on the remote. The preset number and frequency appear, followed by the station name.

To erase the station name

- 1 Tune the station.**
- 2 Press NAME EDIT/SELECT on the remote.**
- 3 Press CLEAR on the remote repeatedly to erase the name.**
- 4 Press ENTER/YES on the remote.**

Using the Radio Data System (RDS)

(European model only)

What is the Radio Data System?

Radio Data System (RDS)* is a broadcasting service that allows radio stations to send additional information along with the regular program signal.

Note

RDS may not work properly if the station you have tuned in is not transmitting the RDS signal properly or if the signal is weak.

* Not all FM stations provide RDS service, nor do they all provide the same type of services. If you are not familiar with the RDS system, check with your local radio stations for details on RDS services in your area.

Receiving RDS broadcasts

Simply select a station from the FM band.

When you tune in a station that provides RDS services, the station name appears in the display.

To check the RDS information

Each time you press DISPLAY on the remote, the display changes as follows:

Station name* → Frequency → Clock display
→ BASS → TREBLE → Station name* →
...

* If the RDS broadcast is not properly received, the station name may not appear in the display.

Loading a tape

- 1 Press **▲ PUSH**.
- 2 Load a recorded/recordable tape into the cassette holder.

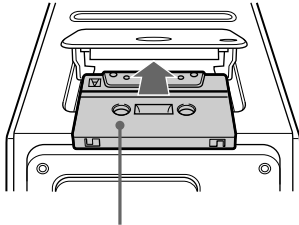

With the side you want to play/
record on facing towards you

Playing a tape

You can use Type I (normal) tape.

- 1 Load a recorded tape into the cassette holder.
- 2 Press **FUNCTION** until “TAPE” appears in the display.
The indicator of TAPE **◀▶** lights up.
- 3 Press **PLAY MODE/DIRECTION** repeatedly to select “**↔**” to play one side of the tape, “**↔↔**” to play both sides, or “**(↔)**”* to play both sides repeatedly.

* The tape automatically stops after playing back five times.

- 4 Press **TAPE ▶◀**.
Press **TAPE ▶◀** again to play the reverse side. The tape starts playing back.

Other Operations

To	Do this
Stop playback	Press TAPE ■ .
Pause	Press TAPE . Press again to resume playback.
Fast-forward or rewind	With the tape stopped, press TAPE ◀◀ or ▶▶ .
Remove the tape	Press ▲ PUSH .

Recording a CD on a tape

— CD-TAPE Synchro Recording

You can use Type I (normal) tape.

- 1 **Load a recordable tape.**
- 2 **Load a CD.**
- 3 **Press SYNCHRO REC repeatedly until “CD-TAPE SYNC” appears in the display.**
- 4 **Press ENTER/START.**
The tape deck stands by for recording and the CD player pauses for play.
When you want to record on the reverse side, press TAPE ◀▶ so that “◀” appears in the display.
- 5 **Press PLAY MODE/DIRECTION repeatedly until “↔” appears to record on one side or “↔↔” (or “(↔↔)”) to record on both sides.**
- 6 **Verify that “Press START” flashes in the display. Then press ENTER/START.**
Recording starts.

To stop recording

Press CD ■ or TAPE ■.

Tips

- When you record on both sides, be sure to start from the front side. If you start from the reverse side, recording stops at the end of the reverse side.
- If you select both sides recording and the tape reaches the end of the front side part-way through a track, the entire track is recorded again from the beginning of the reverse side.
- You can record only your favorite CD tracks with CD Program Play. After step 2, follow the same procedures as from step 1 to 5 in CD Program Play (see page 12). Then go to step 3.

Recording a CD on an MD and a tape at the same time

Load the CD you want to record. Then load a recordable tape and MD. Press SYNCHRO REC repeatedly until “DUAL SYNC” appears and then perform step 4 through 6 of “Recording a CD on a tape”.

To stop recording

Press CD ■, MD ■ or TAPE ■.

Tips

- Even if the MD or the tape ends part-way through the recording, the other continues recording.
- If you select both sides recording and the tape reaches the end of the front side part-way through a track, the entire track is recorded again from the beginning of the reverse side. In this case, the entire track may also be recorded again on the MD.
- You can record only your favorite CD tracks with CD Program Play. After step 2, follow the same procedures as from step 1 to 5 in CD Program Play (see page 12). Then go to step 3.

Recording an MD on a tape

— MD-TAPE Synchro Recording

You can use Type I (normal) tape.

- 1 **Load a recordable tape.**
- 2 **Load an MD.**
- 3 **Press SYNCHRO REC repeatedly until “MD-TAPE SYNC” appears in the display.**

4 Press ENTER/START.

The tape deck stands by for recording and the MD deck pauses for play.

When you want to record on the reverse side, press TAPE ◀▶ so that “◀” appears in the display.

5 Press PLAY MODE/DIRECTION repeatedly until “↔” appears to record on one side or “↔↔” (or “↔↔”) to record on both sides.**6 Verify that “Press START” flashes in the display. Then press ENTER/START.**
MD playing and tape recording start.

To stop recording

Press MD ■ or TAPE ■.

Note

If the tape becomes full during recording, the MD deck and the tape deck stop automatically.

Tips

- You can record only your favorite MD tracks with MD Program Play. After step 2, follow the same procedures as from step 1 to 5 in MD Program Play (see page 16). Then go to step 3.
- When you record on both sides, be sure to start from the front side. If you start from the reverse side, recording stops at the end of the reverse side.
- If you select both sides recording and the tape reaches the end of the front side part-way through a track, the entire track is recorded again from the beginning of the reverse side.

Recording on a tape manually

— Manual Recording

With manual recording, you can record just the portions you like from a CD or an MD on a tape. You can also record a radio program.

You can use Type I (normal) tape.

- 1 Load a recordable tape.**
- 2 Press FUNCTION repeatedly to select the desired source to record.**
- 3 Press ● TAPE.**

The tape deck stands by for recording.

When you want to record on the reverse side, press TAPE ◀▶ so that “◀” appears in the display.

4 Press PLAY MODE/DIRECTION repeatedly until “↔” appears to record on one side or “↔↔” (or “↔↔”) to record on both sides.**5 Press TAPE ■ and then start playing the desired source to record.**

To stop recording

Press TAPE ■.

Tips

- When you record on both sides, be sure to start from the front side. If you start from the reverse side, recording stops at the end of the reverse side.
- If you select both sides recording and the tape reaches the end of the front side part-way through a track, the entire track is recorded again from the beginning of the reverse side.

Adjusting the sound

Generating a more dynamic sound (Dynamic Sound Generator)

Press DSG on the remote.

To cancel the DSG, press DSG on the remote again.

Adjusting the bass and treble

1 Press BASS/TRE on the remote repeatedly to select BASS or TREBLE.

2 While “BASS” or “TREBLE” appears in the display, press ◀◀ or ▶▶ on the remote repeatedly until the level you want appears. You can adjust the bass or treble in 7 steps.

Falling asleep to music

— Sleep Timer

The Sleep Timer Function lets you specify a sleep time, after which the system stops playing and turns off automatically. You can thus fall asleep to music.

Press SLEEP on the remote repeatedly.

The sleep time changes as follows:

AUTO* → 90min → 80min → 70min → ...
→ 10min → OFF → AUTO* → ...

* The system turns off after the current CD or tape finishes playing (up to 100 minutes). The system also turns off when you manually stop the CD or tape.

To	Press
Check the remaining sleep time	SLEEP on the remote once.
Change the sleep time	SLEEP on the remote repeatedly until the time you want appears.
Cancel the Sleep Timer Function	SLEEP on the remote repeatedly until “OFF” appears.

Note

Do not set to “AUTO” during Synchro Recording on an MD or a tape.

Waking up to music

— Daily Timer

By setting the Daily Timer, you can make the system automatically turn on and off at specified times. To use this function, make sure that you have set the system clock correctly (see “Setting the time” on page 9).

1 Prepare the music source you want to listen to when the system turns on.

- CD: Load a CD. To start playing from a specific track, make a program (see “Programming the CD tracks” on page 12).
- MD: Load an MD. To start from a specific track, make a program (see “Programming the MD tracks” on page 16).
- Tape: Load a tape with the side you want to play facing towards you.
- Radio: Tune in the preset radio station that you want (see “Listening to the radio” on page 37).

2 Adjust the volume.

3 Press CLOCK/TIMER SET on the remote.

“DAILY SET” and “⊖ DAILY” appears in the display.

4 Press ENTER/YES on the remote.

“ON” appears, then the hour indication flashes.

5 Set the starting time.

Press ◀◀ or ▶▶ on the remote repeatedly to set the hour, then press ENTER/YES on the remote.

The minute indication begins flashing next.

Press ◀◀ or ▶▶ on the remote repeatedly to set the minute, then press ENTER/YES on the remote.

“OFF” appears, then the hour indication flashes again.

6 Set the stopping time by repeating step 5.

7 Press ◀◀ or ▶▶ on the remote repeatedly until the music source you want appears.

The display changes as follows:

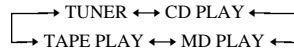

8 Press ENTER/YES on the remote.

The starting time, the stopping time, and the music source appear in turn, then the original display returns.

9 Press I/P to turn off the system.

continued

Waking up to music (continued)

To	Do this
Check the settings/ activate the timer	Press CLOCK/TIMER SELECT on the remote and press ◀◀ or ▶▶ on the remote repeatedly until “DAILY SELECT” appears in the display, then press ENTER/YES on the remote.
Change the setting	Start over from step 1.
Turn off the timer	Press CLOCK/TIMER SELECT on the remote and press ◀◀ or ▶▶ on the remote repeatedly until “TIMER OFF?” appears in the display, then press ENTER/YES on the remote.

Notes

- The system will turn on 30 seconds before the specified starting time. Do not operate the system from the time the system turns on until the daily timer starts. Otherwise the timer will not be activated correctly.
- You cannot use the optional components connected to ANALOG IN jack as the sound source for Daily Timer.

Timer recording radio programs

To timer-record, make sure that you have set the system clock correctly (see “Setting the time” on page 9) and preset the radio station (see “Presetting radio stations” on page 36).

- 1 Tune in the desired preset radio station (see “Listening to the radio” on page 37).**
- 2 Load a recordable tape or MD.**
- 3 Press CLOCK/TIMER SET on the remote.**
“DAILY SET” appears.
- 4 Press **◀◀** or **▶▶** on the remote repeatedly until “MD REC SET” or “TAPE REC SET” appears in the display, then press ENTER/YES on the remote.**
“ON” and “⊖ REC” appear in the display, then the hour indication flashes.
- 5 Set the starting time.**
Press **◀◀** or **▶▶** on the remote repeatedly to set the hour, then press ENTER/YES on the remote.
The minute indication begins flashing next. Press **◀◀** or **▶▶** on the remote repeatedly to set the minute, then press ENTER/YES on the remote.
“OFF” appears, then the hour indication flashes again.
- 6 Set the stopping time by repeating step 5.**
- 7 When you record on an MD, select the recording mode (e.g., LP2) by pressing **◀◀** or **▶▶** on the remote, then press ENTER/YES on the remote.**
The timer recording settings appear, then the original display returns.

8 Press I/O to turn off the system.

To	Do this
Check the settings/ activate the timer	Press CLOCK/TIMER SELECT on the remote and press ◀◀ or ▶▶ on the remote repeatedly until "MD REC?" or "TAPE REC?" appears in the display, then press ENTER/YES on the remote.
Change the setting	Start over from step 1.
Turn off the timer	Press CLOCK/TIMER SELECT on the remote and press ◀◀ or ▶▶ on the remote repeatedly until "TIMER OFF?" appears in the display, then press ENTER/YES on the remote.

Tip

When you record from the radio, the station name (see page 38, or frequency when the station is not labeled), the start time and the stop time are automatically recorded on the MD.

Notes

- The system will turn on 30 seconds before the specified starting time.
- If the system is turned on at the specified starting time, recording will not occur. Do not operate the system from the time the system turns on until the recording starts. Otherwise the timer will not be activated correctly.
- When you record on a brand-new MD, the first 15 seconds are not recorded.
- If the system is on about 30 seconds before the preset time, the timer-recording will not be activated.
- The volume is reduced to minimum during recording.

Hooking up the optional components

You can connect a variety of components to your system in order to enhance it. Make sure that the color of the plugs matches that of the connectors. You can also connect a personal computer to the PC LINK connector and operate the system from the personal computer.

To the audio output jacks on your record player/VCR

To the optical digital output jack of a digital component*

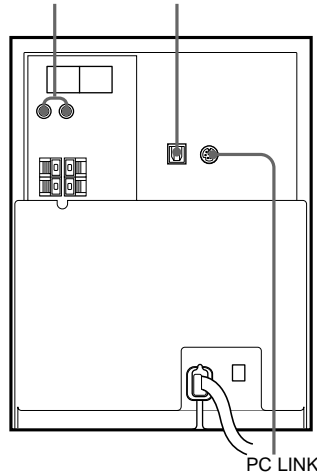

* If the jack is covered with a cap, remove it before use.

To	Do This
Listen to the connected digital component	Press FUNCTION repeatedly until "OPTICAL IN" appears in the display.
Listen to the connected record player/VCR	Press FUNCTION repeatedly until "ANALOG IN" appears in the display.
Operate the system from a personal computer	Connect the personal computer to the PC LINK connector using a Sony PC connection kit (option) that supports this system.

Precautions

On operating voltage

Before operating the system, check that the operating voltage of your system is identical with the voltage of your local power supply.

On safety

- The unit is not disconnected from the AC power source (mains) as long as it is connected to the wall outlet, even if the unit itself has been turned off.
- Unplug the system from the wall outlet (mains) if it will not be used for an extended period of time. To disconnect the power cord (mains lead), pull it out by the plug. Never pull the cord itself.
- Should any solid object or liquid fall into the system, unplug the system and have it checked by qualified personnel before operating it any further.
- AC power cord must be changed only at the qualified service shop.

On placement

- Do not place the system in an inclined position.
- Do not place the system in locations where it is:
 - Extremely hot or cold
 - Dusty or dirty
 - Very humid
 - Subject to vibrations
 - Subject to direct sunlight

On heat buildup

- Although the unit heats up during operation, this is not a malfunction.
- Place the system in a location with adequate ventilation to prevent heat build-up in the system.

If you continuously use this system at a large volume, the cabinet temperature of the top, side and bottom rises considerably. To avoid burning yourself, do not touch the cabinet.

To prevent a malfunction, do not cover the ventilation hole for the cooling fan.

On operation

- If the system is brought directly from a cold place to a warm place, or is placed in a very damp room, moisture may condense on the lens inside the CD player. Should this occur, the system will not operate properly. Remove the CD and leave the system turned on for about an hour until the moisture evaporates.
- When moving the unit, remove any disc that may be on the disc tray.

If you have any questions or problems concerning your system, please consult your nearest Sony dealer.

On the speaker system

This speaker system is not magnetically shielded and the picture on TV sets may become magnetically distorted. In such a case, turn off the power of the TV set once, and after 15 to 30 minutes turn it on again.

If there seems to be no improvement, locate the speaker system further away from the TV set. Also, be sure not to place objects in which magnets are attached or used near the speaker system, such as audio racks, TV stands, and toys. These may cause magnetic distortion to the picture due to their interaction with the system.

Notes on MDs

- If you try to force the shutter open, the disc may be damaged. If the shutter opens, close it immediately without touching the disc inside.
- Affix the label supplied with the disc only to the specified label indentation. Do not affix the label around the shutter or in other locations. Note that the shape of the indentation depends on the disc.

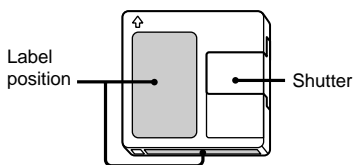

- Wipe the disc cartridge with a dry cloth to remove dirt.
- Do not expose the MD to direct sunlight or heat sources such as hot air ducts, nor leave it in a car parked in direct sunlight.

- With the following kinds of CDs, you may experience a reading failure or noise when recorded on an MD:
 - CDs with adhesive labels attached to them.
 - Irregularly shaped CDs (for example, heart- or star-shaped).
 - CDs with printed text concentrated on one side only.
 - Old CDs.
 - Scratched CDs.
 - Dirty CDs.
 - Warped CDs.
- If the following occurs during CD playback or recording, a reading error may occur or noise may be produced in the recorded results:
 - The CD tray or other part of the system is bumped.
 - The system is placed on an uneven or soft surface.
 - The system is located near a speaker, door, or other source of vibration.
- If a reading error occurs, an extra track with no sound may be created. This extra track can be erased by using the editing function (see page 29).

Notes on CDs

- Before playing a CD, clean the CD surface with a cleaning cloth. Wipe the CD from the center out.
- Do not play a CD with tape, stickers, or adhesives on any of its surfaces as this may damage the system.
- Do not use solvents.
- Do not expose the CDs to direct sunlight or heat sources.
- Discs with non-standard shapes (e.g., heart, square, star) cannot be played on this system. Attempting to do so may damage the system. Do not use such discs.

Note on CD-R/CD-RW playback

Discs recorded on CD-R/CD-RW drives may not be played back because of scratches, dirt, recording condition or the drive's characteristics. Besides, the discs, which are not yet finalized at the end of recording, cannot be played back.

Cleaning the cabinet

Clean the cabinet, panel and controls with a soft cloth slightly moistened with mild detergent solution. Do not use any type of abrasive pad, scouring powder or solvent such as thinner, benzene or alcohol.

To save a tape permanently

To prevent a tape from being accidentally recorded over, break off the cassette tabs from side A or side B as illustrated.

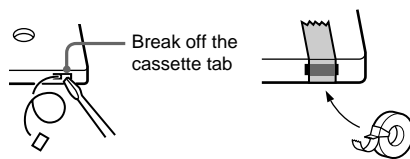

If you later want to reuse the tape for recording, cover the broken tab with adhesive tape.

Before placing a cassette in the tape deck

Take up any slack in the tape. Otherwise the tape may get entangled in the tape deck's playing mechanism and become damaged.

When using a tape longer than 90 minutes

The tape is very elastic. Do not change the tape operations such as play, stop, and fast-winding etc. too frequently. The tape may get entangled in the tape deck's playing mechanism.

Cleaning the tape heads

Clean the tape heads after every 10 hours of use. Make sure to clean the tape heads before making an important recording or after playing an old tape. Use a commercially available dry-type or wet-type cleaning cassette. For details, refer to the instructions of the cleaning cassette.

Demagnetizing the tape heads

Demagnetize the tape heads and the metal parts that have contact with the tape after every 20 to 30 hours of use with a commercially available demagnetizing cassette. For details, refer to the instructions of the demagnetizing cassette.

System limitations of MDs

The recording system in your MD deck has the limitations described below.

Note, however, that these limitations are due to the inherent nature of the MD recording system itself, not to mechanical causes.

“Disc Full!” appears before the MD has reached the maximum recording time

When 255 tracks have been recorded on the MD, “Disc Full!” appears regardless of the total recorded time. More than 255 tracks cannot be recorded on the MD. To continue recording, erase unnecessary tracks or use another recordable MD.

“Disc Full!” appears before the maximum number of tracks (255) is reached

Fluctuations in emphasis within tracks are sometimes interpreted as track intervals, increasing the track count and causing “Disc Full!” to appear.

The remaining recording time does not increase even after erasing numerous short tracks

Tracks shorter than 12 seconds* are not counted, so erasing them may not increase the recording time.

* During stereo recording. (approximately 24 seconds during monaural and LP2 stereo recording, or 48 seconds during LP4 stereo recording)

Some tracks cannot be combined with others

Tracks may not be combined if they have been edited.

The total recorded time and the remaining time on the MD do not add up to the maximum recording time

Recording is done in minimum units of 2 seconds* each, no matter how short the material. The recorded contents may be shorter than the maximum recording capacity. Disc space may also be reduced by scratches.

* During stereo recording. (approximately 4 seconds during monaural and LP2 stereo recording, or 8 seconds during LP4 stereo recording)

The sound may drop-out while searching the edited tracks

Tracks created through editing may exhibit sound dropout during searching because high-speed playback requires time to search for the position on the disc when the tracks are not in order.

Track numbers cannot be marked

When “L-SYNC” (page 23) lights up in the display window during analog recording, the track numbers may not be marked at the beginning of the track:

- if the input signal is below a certain fixed level for less than 2 seconds between tracks.
- if the input signal is below a certain fixed level for more than 2 seconds in the middle of the track.
- if you record a track that is 4 seconds or less*.
 - * During Stereo, Monaural or LP2 Stereo recording mode. (In LP4 Stereo recording mode: 8 seconds or less)

Extra tracks are created

When there is a long silence between CD tracks, an extra track may be created.

Guide to the Serial Copy Management System

Digital audio components, such as CDs, MDs, and DATs let you copy music easily with high quality by processing music as a digital signal.

To protect the copyrighted music programs, this system uses the Serial Copy Management System that allows you to make only a single copy of a digitally recorded source through digital-to-digital connections.

You can make only a first generation copy* through a digital-to-digital connection.

That is:

- 1 You can make a copy of a commercially available digital sound program (for example, a CD or MD), but you cannot make a second copy from the first-generation copy.
- 2 You can make a copy of a digital signal from a digitally recorded analog sound program (for example, an analog record or a music cassette tape) or from a digital satellite broadcast program, but you cannot make a second copy.

* A first-generation copy means a digital recording of a digital signal made on digital audio equipment. For example, if you record from this system's CD player to the MD deck, you make a first-generation copy.

Troubleshooting

If you have any problem using this system, use the following checklist.

First, check that the power cord is connected firmly and that the speakers are connected correctly and firmly.

Should any problem persist, consult your nearest Sony dealer.

General

There is no sound.

- Turn VOLUME clockwise.
 - Make sure the headphones are not connected.
 - Check the speaker connections (see page 6).
 - There is no sound output during CD-MD High-Speed Synchro Recording.
-

Sound comes from one channel, or unbalanced left and right volume.

- Connect the speaker cords properly (see page 6).
 - Place the speakers as symmetrically as possible.
 - Connect only one of the supplied speakers to each set of speaker terminals.
 - Connect the supplied speakers.
-

There is severe hum or noise.

- Move the system away from the source of noise.
 - Connect the system to a different wall outlet.
 - Install a noise filter (commercially available) to the power line.
-

"- -: -" appears in the display.

- Set the clock and timer again (see page 9).
-

The timer cannot be set.

- Set the clock again (see page 9).
-

continued

Troubleshooting (continued)

The timer does not function.

- Press CLOCK/TIMER SELECT on the remote and light up “DAILY” or “REC” in the display (see pages 44 and 45).
 - Check the set contents and set the correct time (see pages 43 to 45).
 - Cancel the Sleep Timer function (see page 42).
 - You cannot activate Daily Timer and recording timer at the same time.
-

The remote does not function.

- Remove the obstacle.
 - Move the remote closer to the system.
 - Point the remote at the system’s sensor.
 - Replace the batteries (size-AA/R6).
 - Locate the system away from the fluorescent light.
-

CD Player

The CD tray does not close.

- Place the CD correctly in the center of the tray.
 - Always close the tray by pressing CD . Trying to push the tray closed with your fingers may cause problems with the CD player.
-

The CD does not eject.

- Consult your nearest Sony dealer.
-

Play does not start.

- Open the CD tray and check whether a CD is loaded.
 - Wipe the CD clean (see page 47).
 - Replace the CD.
 - The CD is loaded with the label side down. Place the CD correctly in the center of the tray.
 - Remove the CD and wipe away the moisture on the CD, then leave the system turned on for a few hours until the moisture evaporates.
 - Press CD  to start play.
-



The sound skips.

- Wipe the CD clean (see page 47).
 - Replace the CD.
 - Try moving the system to a place without vibration (e.g., on top of a stable stand).
 - Try moving the speakers away from the system, or placing them on separate stands.
When you listen to a track with bass sounds at high volume, the speaker vibration may cause the sound to skip.
-

Play does not start from the first track.

- Press PLAY MODE/DIRECTION (or PLAY MODE on the remote) repeatedly until “PGM” or “SHUFFLE” disappears to return to normal play.
-

“OVER” appears.

- Press and hold CD  or press CD  to return to the desired playing position.
-

MD Deck

An MD cannot be loaded.

- Load the MD with the arrow side up and the arrow pointing toward the deck.
-

The controls do not work.

- Replace the MD with a new one.
 - Retry the operations after “TOC” or “STANDBY” turns off.
-

Play does not start.

- Replace the MD.
 - Insert the MD and leave the system turned on for a few hours until the moisture evaporates.
 - Press MD  to start play.
-

The sound skips.

- Replace the MD.
 - Try moving the system to a place without vibration (e.g., on top of a stable stand).
 - Try moving the speakers away from the system, or placing them on separate stands.
When you listen to a track with bass sounds at high volume, the speaker vibration may cause the sound to skip.
 - Load the disc and wait for 10 to 20 minutes with the system turned on.
-

Play does not start from the first track.

- Press PLAY MODE/DIRECTION (or PLAY MODE on the remote) in stop mode repeatedly until “PGM” or “SHUFFLE” disappears to return to normal play.

“OVER” appears.

- Press and hold MD ◀◀ or press MD ◀◀ to return to the desired playing position.

“OVER” lights up during recording.

- Set the volume of the connected component lower.
- Adjust the recording level lower (see page 25).

Recording or editing was done, but the TOC is not updated.

- MD recording and editing contents are recorded to the MD when the MD is removed, so make sure you remove the MD after recording or editing (see pages 18 and 26).

Recording is not possible.

- Remove the MD and slide the tab to close the slot (see page 18).
- Connect the optional A/V component properly (see page 45).
- Switch to another sound source.
- Replace the MD with a recordable MD, or use Erase Function to erase unnecessary tracks (see page 29).

The sound from an MD you recorded is too low (or too high).

- Readjust the recording level (see page 25).
-

Tape Deck

The tape does not record.

- No cassette is loaded. Load a cassette.
- The tab has been removed from the cassette. Cover the broken tab with adhesive tape (see page 47).
- The tape has wound to the end.

The tape does not record or play, or there is a decrease in sound level.

- The heads are dirty. Clean them.
- The record/playback heads are magnetized. Demagnetize them (see page 47).

The tape does not erase completely.

- The record/playback heads are magnetized. Demagnetize them (see page 47).

There is excessive wow or flutter, or the sound drops out.

- The capstans or pinch rollers in the tape deck are dirty. Clean them using a cleaning cassette (see page 47).

Noise increases or the high frequencies are erased.

- The record/playback heads are magnetized. Demagnetize them (see page 47).
-

continued

Troubleshooting (continued)

Optional components

There is no sound.

- Refer to General item “There is no sound” on page 49 and check the condition of the system.
 - Connect the component properly (see page 45) while checking:
 - if the cords are connected properly.
 - if the cord plugs are firmly inserted all the way.
 - Turn on the connected component.
 - Refer to the operating instructions included with the connected component and start playing.
-

The sound is distorted.

- Set the volume of the connected component lower.
-

Tuner

There is severe hum or noise (“TUNED” or “STEREO” flashes).

- Set the proper band and frequency (see page 36).
- Connect the antenna properly (see page 6).
- Find a place and an orientation that provide good reception, then set up the antenna again.

If you cannot obtain good reception, we recommend you connect a commercially available external antenna.

- The supplied FM lead antenna receives signals along its entire length, so make sure you extend it fully.
 - Locate the antennas as far away from the speaker cords as possible.
 - Consult your nearest Sony dealer if the supplied AM antenna wire has come off the plastic stand.
 - Try turning off surrounding electrical equipment.
-

A stereo FM program cannot be received in stereo.

- Press STEREO/MONO until “STEREO” appears in the display.
 - See “There is severe hum or noise (“TUNED” or “STEREO” flashes)”, and check the antenna condition.
-

Cyclical static noise is heard while recording on an MD.

- Adjust the antenna orientation and position until the noise stops.
-

If the system still does not operate properly after performing the above measures, reset the system as follows:

- 1** Disconnect the power cord from the wall outlet.
- 2** Reconnect the power cord to a wall outlet.
- 3** Press I/⏻.
- 4** Press TAPE ■, ● MD, and MD ►► at the same time.

Self-diagnosis display

This system has a Self-diagnosis display function to let you know if there is a system malfunction. The display shows a code made up of three letters and a message alternately to show you the problem. To solve the problem refer to the following list. If any problem persists, consult your nearest Sony dealer.

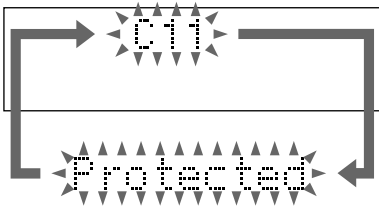

C11/Protected

The MD is protected against erasure.

- Remove the MD and slide the tab to close the slot (see page 18).

C12/Cannot Copy

You tried to record a CD or MD with a format that the system does not support, such as a CD-ROM.

- Remove the disc and turn off the system once, then turn it on again.

C13/REC Error

Recording could not be performed properly.

- Move the system to a stable place, and start recording over from the beginning.

The MD is dirty or scratched, or the MD does not meet the standards.

- Replace the MD and start recording over from the beginning.

C14/Read Error

The MD deck cannot read the disc information properly.

- Remove the MD once, then load it again.
-

C14/Toc Error

The MD deck cannot read the disc information properly.

- Replace the MD.
 - Erase all the recorded contents of the MD using All Erase Function (see page 29).
-

C41/Cannot Copy

The sound source is a copy of commercially available music software.

- The Serial Copy Management System prevents making a digital copy (see page 49).
-

Messages

One of the following messages may appear or flash in the display during operations.

MD

Auto Cut

The MD deck is pausing the recording because silence continued for 30 seconds or more during recording.

Blank Disc

The inserted recordable MD is new, or all tracks on the MD have been erased.

Cannot Edit

- A pre-mastered MD is in the deck.
- You tried to edit in Program or Shuffle Play mode.

Cannot REC

- A pre-mastered MD is in the deck.
- The function is switched to MD.

Cannot SYNC

- There is no disc in the MD deck, or the MD is protected against erasure.
- There is no time remaining on the MD.

Complete !

The editing operation of MDs is completed.

continued

Self-diagnosis display (continued)

Disc Full!

There is no time remaining on the MD.

Eject

The MD deck is ejecting the MD.

Impossible

- You tried to make an impossible editing operation.
 - You cannot combine or erase the tracks due to the system limitations of MDs.
 - “Impossible” appears, when you specify the division point at the beginning or end of a track. Press MD **◀◀** or **▶▶** to shift the position.
-

Incomplete!

Adjustment of the recording level after recording or Fade-in and Fade-out procedures have failed since the unit was either subject to vibration or there is a damaged or dirty disc in the tray. Place the unit in a stable place to minimize shock and vibration. Do not use damaged or dirty discs.

MD No Disc

There is no disc in the MD deck.

Name Full

There is no more space to store track or disc titles.

No Change

When changing the recording level after recording, the recording level did not change since you pressed ENTER/YES without making the adjustment.

No Name

You tried to show the title of a non-labeled disc or track.

OVER

You have reached the end of the MD while press and hold MD **▶▶** during playing pause.

Push STOP!

You pressed PLAY MODE/DIRECTION (or PLAY MODE on the remote) during play.

—Rehearsal—

The MD is playing the specified dividing point for confirmation during the A-B Erase function or the Divide function.

S.F Edit!

You attempted to perform other operations during S.F Edit (adjusting the recording level after recording, Fade-in and Fade-out). You cannot perform other operations during S.F Edit.

S.F Edit NOW

You pressed **I/⏪** during S.F Edit (adjusting the recording level after recording, Fade-in and Fade-out). If you turn off the power before S.F Edit is finished, the editing will not be properly overwritten. Turn the power off after editing is complete.

If you want to turn off the power during editing, press **I/⏪** again while the message is displayed.

Smart Space

The signal was input again after silence continued for 3 or more but less than 30 seconds during digital recording.

Standby (flashing)

The timer-recorded material has disappeared over time and is not available for saving to disc, or Program Play could not be activated since the program has disappeared over time.

Step Full!

You try to program 26 or more tracks (steps).

Text Protect

There is CD TEXT information which cannot be recorded on the MD.

TOC Reading

The MD deck is reading the TOC information of the MD.

TOC Writing

The MD deck is writing the information of recorded or edited contents.

Track End

You have reached the end of the track while adjusting the dividing point during the Divide Function.

TUNER

Cannot Edit

You tried to label or erase a non-preset station.

CD

Cannot Edit

You tried to label a CD TEXT disc.

CD No Disc

There is no CD in the player.

Name Full

There are already 50 disc titles stored in the system.

OVER

You have reached the end of the CD while keeping pressing CD ►► during play or pause.

Step Full!

You try to program 26 or more tracks (steps).

TAPE

Cannot SYNC

There is no tape in the tape deck, or the tab has been removed from the cassette.

No Tab

You cannot record the tape because the tab has been removed from the cassette.

No Tape

There is no tape in the tape deck.

Specifications

Amplifier section

European model:

DIN power output (rated): 30 + 30 W
(6 ohms at 1 kHz, DIN)

Continuous RMS power output (reference):

35 + 35 W
(6 ohms at 1 kHz, 10% THD)

Music power output (reference):

85 + 85 W

Other models:

The following measured at 230 V AC, 60 Hz

DIN power output (rated): 30 + 30 W
(6 ohms at 1 kHz, DIN)

Continuous RMS power output (reference):

35 + 35 W
(6 ohms at 1 kHz, 10% THD)

The following measured at 220 V AC, 60 Hz

DIN power output (rated): 24 + 24 W
(6 ohms at 1 kHz, DIN)

Continuous RMS power output (reference):

27 + 27 W
(6 ohms at 1 kHz, 10% THD)

Inputs

ANALOG IN (phono jacks):

Sensitivity 250 mV,
impedance 47 kilohms

DIGITAL OPTICAL IN (Supported sampling frequencies: 32 kHz, 44.1 kHz and 48 kHz)

Outputs

PHONES (stereo minijack):

Accepts headphones with an impedance of 8 ohms or more

SPEAKER:

Accepts impedance of 6 to 16 ohms

continued

Specifications (continued)

CD player section

System	Compact disc and digital audio system
Laser	Semiconductor laser ($\lambda = 780$ nm) Emission duration: continuous
Wavelength	780 – 790 nm
Frequency response	2 Hz – 20 kHz (± 0.5 dB)

Tape player section

Recording system	4-track 2-channel stereo
Frequency response	50 – 13,000 Hz (± 3 dB), using a Sony TYPE I cassette
Wow and flutter	$\pm 0.15\%$ W. Peak (IEC) 0.1% W. RMS (NAB) $\pm 0.2\%$ W. Peak (DIN)

MD deck section

System	MiniDisc digital audio system
Laser	Semiconductor laser ($\lambda = 780$ nm) Emission duration: continuous
Sampling frequency	44.1 kHz
Frequency response	5 Hz – 20 kHz

Tuner section

FM stereo, FM/AM superheterodyne tuner

FM tuner section

Tuning range	76.0 – 108.0 MHz
Tourist model:	(50 kHz step) 87.5 – 108.0 MHz
Other models:	(50 kHz step) FM wire antenna
Antenna	75 ohm unbalanced
Antenna terminals	10.7 MHz
Intermediate frequency	

AM tuner section

Tuning range	531 – 1,602 kHz
European model:	(with the tuning interval set at 9 kHz)
Other models:	530 – 1,710 kHz (with the tuning interval set at 10 kHz)
	531 – 1,602 kHz (with the tuning interval set at 9 kHz)
Antenna	AM loop antenna, external antenna terminal
Intermediate frequency	450 kHz

Speakers

Speaker system	Two-way, bass reflex system
Speaker units	12 cm dia., cone type woofer 2.5 cm dia., semi-dome-type tweeter
Rated impedance	6 ohms
Dimensions (w/h/d)	Approx. 150 × 253 × 260 mm
Mass	Approx. 3.0 kg net per speaker

General

Power requirements
European model: 230 V AC, 50/60 Hz
Hong Kong model: 220 – 240 V AC,
50/60 Hz
Other models: 110 – 120 V or 220 –
240 V AC , 50/60 Hz
Adjustable with voltage
selector

Power consumption
European model: See the nameplate
0.5 W (in the standby
mode)

Other models: See the nameplate

Dimensions (w/h/d) Approx. 190 × 253 ×
345 mm incl. projecting
parts and controls

Mass Approx. 7.0 kg

Supplied accessories Remote commander (1)
AM loop antenna (1)
FM wire antenna (1)
Batteries (2)
Color trim (brown) (1)
Color window (brown) (1)
Speaker grille net (brown)
(2)
CMT-DC500MD/S: Speaker grille net cover
(silver) (2)
CMT-DC500MD/X: Color trim (orange) (1)
Color window (orange)
(1)
Speaker grille net (orange)
(2)
CMT-DC500MD/W: Color trim (lavender) (1)
Color window (lavender)
(1)
Speaker grille net
(lavender) (2)
Speaker grille net cover
(white) (2)

Optional accessories

PCLK-MN10A Sony PC
connection kit
SSN-J300 adorning kit
Color trim (1)
Color window (1)
Speaker grille net (2)
The optional accessories
for this system are subject
to change without notice.
For details, consult your
nearest Sony dealer.

Design and specifications are subject to change
without notice.

<http://www.world.sony.com/>

Sony Corporation Printed in Korea
