

Compact AV System

Operating Instructions



DAV-S550

WARNING

To prevent fire or shock hazard, do not expose the unit to rain or moisture.

Do not install the appliance in a confined space, such as a bookcase or built-in cabinet.

To prevent fire, do not cover the ventilation of the apparatus with news papers, table-cloths, curtains, etc. And don't place lighted candles on the apparatus.

To prevent fire or shock hazard, do not place objects filled with liquids, such as vases, on the apparatus.

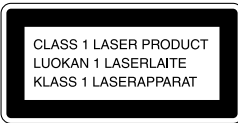

This appliance is classified as a CLASS 1 LASER product. The label is located on the bottom exterior.



Don't throw away the battery with general house waste, dispose of it correctly as chemical waste.

Precautions

Safety

- If anything falls into the cabinet, unplug the unit and have it checked by qualified personnel before operating it any further.
- The unit is not disconnected from the mains as long as it is connected to the mains outlet, even if the unit itself has been turned off.
- Unplug the unit from the wall outlet if you do not intend to use it for an extended period of time. To disconnect the cord, pull it out by the plug, never by the cord.

Installing

- Do not install the appliance in a confined space, such as a bookcase or built-in cabinet.
- Allow adequate air circulation to prevent internal heat buildup.
- Do not place the unit on surfaces (rugs, blankets, etc.) or near materials (curtains, draperies) that may block the ventilation slots.
- Do not install the unit near heat sources such as radiators, or air ducts, or in a place subject to direct sunlight, excessive dust, mechanical vibration, or shock.
- Do not install the unit in an inclined position. It is designed to be operated in a horizontal position only.
- Keep the unit and discs away from equipment with strong magnets, such as microwave ovens, or large loudspeakers.
- Do not place heavy objects on the unit.
- If the unit is brought directly from a cold to a warm location, moisture may condense inside the Compact AV System and cause damage to the lenses. When you first install the unit, or when you move it from a cold to a warm location, wait for about 30 minutes before operating the unit.

Welcome!

Thank you for purchasing this Sony Compact AV System. Before operating this system, please read this manual thoroughly and retain it for future reference.

Precautions

On safety

Should any solid object or liquid fall into the cabinet, unplug the system and have it checked by qualified personnel before operating it any further.

On power sources

AC power cord must be changed only at the qualified service shop.

On placement

- Place the system in a location with adequate ventilation to prevent heat build-up in the system.
- At high volume, over long periods of time, the cabinet becomes hot to the touch. This is not a malfunction. However, touching the cabinet should be avoided. Do not place the unit in a confined space where ventilation is poor as this may cause overheating.
- Do not block the ventilation slots by putting anything on the system. The system is equipped with a high power amplifier. If the ventilation slots on the top surface are blocked, the unit can overheat and malfunction.
- Do not place the system on a soft surface such as a rug that might block the ventilation holes on the bottom.
- Do not place the system in a location near heat sources, or in a place subject to direct sunlight, excessive dust, or mechanical shock.

On operation

- If the system is brought directly from a cold to a warm location, or is placed in a very damp room, moisture may condense on the lenses inside the system. Should this occur, the system may not operate properly. In this case, remove the disc and leave the system turned on for about half an hour until the moisture evaporates.
- When you move the system, take out any discs. If you don't, the disc may be damaged.
- For power saving purposes, the system can be completely turned off by the POWER button on the main unit. Though the LED remains lit for a while, the system is completely off.

On adjusting volume

Do not turn up the volume while listening to a section with very low level inputs or no audio signals. If you do, the speakers may be damaged when a peak level section is played.

On cleaning

Clean the cabinet, panel, and controls with a soft cloth slightly moistened with a mild detergent solution. Do not use any type of abrasive pad, scouring powder or solvent such as alcohol or benzene.

If you have any questions or problems concerning your system, please consult your nearest Sony dealer.

On cleaning discs

Do not use a commercially available CD/DVD cleaning disc. It may cause a malfunction.

On your TV's color

If the speakers should cause the TV screen to have color irregularity, turn off the TV at once then turn it on after 15 to 30 minutes. If color irregularity should persist, place the speakers further away from the set.

The nameplate is located on the bottom exterior.

IMPORTANT NOTICE

Caution: This system is capable of holding a still video image or on-screen display image on your television screen indefinitely. If you leave the still video image or on-screen display image displayed on your TV for an extended period of time you risk permanent damage to your television screen. Projection televisions are especially susceptible to this.

On carrying the system

When you carry the system, use the following procedure to protect the inner mechanism. Remove the disc, and then press and hold the ■ button on the system. After "MECHA LOCK" is displayed on the front panel display, turn off the system.

Table of Contents

WARNING	2
Welcome!	3
Precautions	4
About this Manual	7
This system Can Play the Following Discs	7
Notes about the Discs	9
Index to Parts and Controls	10
Guide to the Control Menu Display	14
<hr/>	
Getting Started	16
Quick Overview	16
Unpacking	16
Inserting Batteries into the Remote	17
Step 1: Speaker System Hookup	17
Step 2: Antenna Hookups	20
Step 3: TV and Video Component Hookups	22
Speaker Setup	24
Presetting Radio Stations	29
<hr/>	
Playing Discs	31
Playing Discs	31
Resuming Playback from the Point Where You Stopped the Disc (Resume Play)	32
Using the DVD's Menu	33
Playing VIDEO CDs with PBC Functions (PBC Playback)	34
Playing an MP3 Audio Track	35
Creating Your Own Program (Program Play)	36
Playing in random order (Shuffle Play)	38
Playing repeatedly (Repeat Play)	39
<hr/>	
Searching for a Scene	40
Searching for a Particular Point on a Disc (Scan, Slow-motion Play)	40
Searching for a Title/Chapter/Track/Index/Album	41
<hr/>	
Viewing Information About the Disc	43
Viewing the Playing Time and Remaining Time on the Front Panel Display	43
Checking the Playing Time and Remaining Time	44

Sound Adjustments	46
Changing the Sound	46
Automatically decoding the input audio signal (Auto Decoding)	48
Enjoying Surround Sound	48
Using only the front speakers and subwoofer (2 Channel Stereo)	51
Adjusting the level parameters	51

Enjoying Movies	52
Changing the Angles	52
Displaying the Subtitles	53

Using Various Additional Functions	54
Locking Discs (CUSTOM PARENTAL CONTROL, PARENTAL CONTROL) ...	54







Other Operations	59
Controlling the TV with the Supplied Remote	59
Using the Video or other Unit	60
Listening to the Radio	61
Using the Radio Data System (RDS) (Only for the European models)	62
Naming Preset Stations	62

Settings and Adjustments	64
Using the Setup Display	64
Setting the Display or Sound Track Language (LANGUAGE SETUP)	65
Settings for the Display (SCREEN SETUP)	66
Custom Settings (CUSTOM SETUP)	68
Settings for the Speakers (SPEAKER SETUP)	69

Additional Information	72
Troubleshooting	72
Self-diagnosis Function (When letters/numbers appear in the display)	76
Glossary	76
Specifications	79
Language Code List	81
DVD Setup Menu List	82
Index	83
Quick reference for Remote Commander	Back cover

About this Manual

- The instructions in this manual describe the controls on the remote. You can also use the controls on the system if they have the same or similar names as those on the remote.
- The icons used in this manual are explained below:

Icon	Meaning	Icon	Meaning
	Functions available in DVD video mode		Functions available in Super Audio CD and Audio CD mode
	Functions available in VIDEO CD mode		Functions available for MP3* audio tracks
	Functions available in CD mode		More convenient features

- In this manual, the European model is used for illustration and on-screen display (OSD) purposes.

* MP3 (MPEG1 Audio Layer 3) is a standard format defined by ISO/MPEG which compress audio data.

This system Can Play the Following Discs

Format of discs	
DVD VIDEO	
Super Audio CD	
VIDEO CD	
Music CD	

The "DVD VIDEO" logo is a trademark.

Terms for discs

• Title

The longest sections of a picture or music feature on a DVD, movie, etc., in video software, or the entire album in audio software.

• Chapter

Sections of a picture or a music piece that are smaller than titles. A title is composed of several chapters. Depending on the disc, no chapters may be recorded.

• Album

Section of a music piece on a data CD containing MP3 audio tracks.

• Track

Sections of a picture or a music piece on a VIDEO CD, Super Audio CD, CD, or MP3.

• Index (Super Audio CD, CD) / Video Index (VIDEO CD)

A number that divides a track into sections to easily locate the point you want on a VIDEO CD or Super Audio CD.

Depending on the disc, no indexes may be recorded.

• Scene

On a VIDEO CD with PBC functions (page 34), the menu screens, moving pictures and still pictures are divided into sections called "scenes."

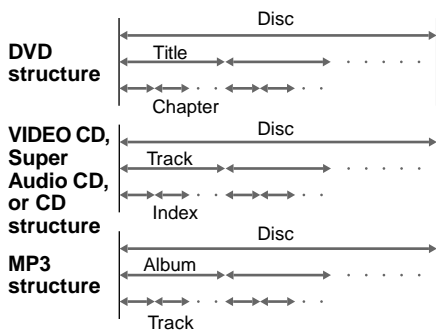

Note on PBC (Playback Control) (VIDEO CDs)

This system conforms to Ver. 1.1 and Ver. 2.0 of VIDEO CD standards. You can enjoy two kinds of playback depending on the disc type.

Disc type	You can
VIDEO CDs without PBC functions (Ver. 1.1 discs)	Enjoy video playback (moving pictures) as well as music.
VIDEO CDs with PBC functions (Ver. 2.0 discs)	Play interactive software using menu screens displayed on the TV screen (PBC Playback), in addition to the video playback functions of Ver. 1.1 discs. Moreover, you can play high-resolution still pictures, if they are included on the disc.

Region code

Your system has a region code printed on the back of the unit and will only play DVDs labelled with the same region code.

DVDs labelled  will also play on this system.

If you try to play any other DVD, the message “Playback prohibited by area limitations.” will appear on the TV screen. Depending on the DVD, no region code indication may be labelled even though playing the DVD is prohibited by area restrictions.

Examples of discs that the system cannot play

The system cannot play the following discs:

- CD-ROMs (PHOTO CDs included)
- CD-Rs/CD-RWs other than those recorded in the following formats:
 - music CD format
 - video CD format
 - MP3 format that conforms to ISO9660* Level 1/Level 2, or its extended format, Joliet
- Data part of CD-Extras
- DVD-ROMs
- DVD Audio discs

* A logical format of files and folders on CD-ROMs, defined by ISO (International Standard Organization)

Do not load the following discs:

- A DVD with a different region code (page 8, 78).
- A disc that is neither standard nor circular (e.g., card, heart, or star shape).
- A disc with paper or stickers on it.
- A disc that has the adhesive, cellophane tape, or a sticker still left on it.

Note

Some CD-Rs or CD-RWs cannot be played on this system depending upon the recording quality or physical condition of the disc, or the characteristics of the recording device.

Furthermore, the disc will not play if it has not been correctly finalized. For more information, see the operating instructions for the recording device.

Note on playback operations of DVDs and VIDEO CDs

Some playback operations of DVDs and VIDEO CDs may be intentionally set by software producers. Since this system plays DVDs and VIDEO CDs according to the disc contents the software producers designed, some playback features may not be available. Also, refer to the instructions supplied with the DVDs or VIDEO CDs.

Copyrights

This product incorporates copyright protection technology that is protected by method claims of certain U.S. patents, other intellectual property rights owned by Macrovision Corporation, and other rights owners. Use of this copyright protection technology must be authorized by Macrovision Corporation, and is intended for home and other limited viewing uses only unless otherwise authorized by Macrovision Corporation. Reverse engineering or disassembly is prohibited.

This system incorporates with Dolby* Digital and Dolby Pro Logic (II) adaptive matrix surround decoder and the DTS** Digital Surround System.

- * Manufactured under license from Dolby Laboratories.
“Dolby”, “Pro Logic” and the double-D symbol are trademarks of Dolby Laboratories.
- ** Manufactured under license from Digital Theater Systems, Inc.
“DTS” and “DTS Digital Surround” are trademarks of Digital Theater Systems, Inc.

Notes about the Discs

On handling discs

- To keep the disc clean, handle the disc by its edge. Do not touch the surface.
- Do not stick paper or tape on the disc.



- Do not expose the disc to direct sunlight or heat sources such as hot air ducts, or leave it in a car parked in direct sunlight as the temperature may rise considerably inside the car.
- After playing, store the disc in its case.

On cleaning

- Before playing, clean the disc with a cleaning cloth.
Wipe the disc from the center out.



- Do not use solvents such as benzine, thinner, commercially available cleaners, or anti-static spray intended for vinyl LPs.

This system can only play back a standard circular disc. Using neither standard nor circular discs (e.g., card, heart, or star shape) may cause a malfunction.

Do not use a disc that has a commercially available accessory attached, such as a label or ring.

Index to Parts and Controls

For more information, refer to the pages indicated in parentheses.

Front Panel

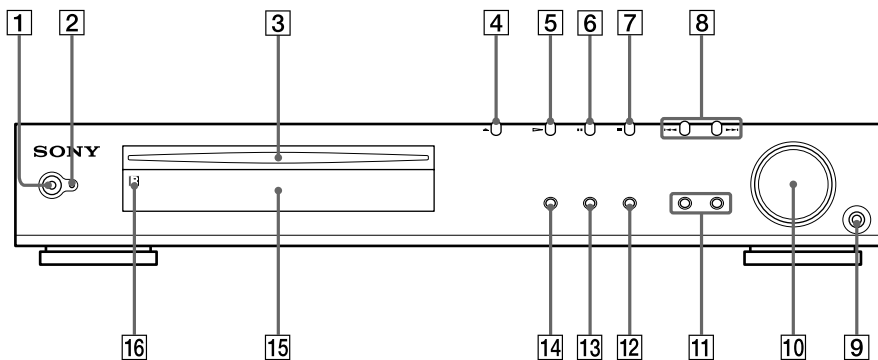

- 1** POWER switch (31)
- 2** STANDBY indicator (31)
- 3** Disc slot (31)
- 4** ⏏ (Eject) (31)
- 5** ▶ (play) (31)
- 6** ⏸ (pause) (32)
- 7** ■ (stop) (30, 31)
- 8** ⏮/▶⏭ PREV/NEXT, PRESET -/+ (32, 61)

- 9** PHONES jack (31)
- 10** VOLUME control (31, 71)
- 11** SOUND FIELD -/+ (48, 51)
- 12** DISPLAY (61)
- 13** BAND (29)
- 14** FUNCTION (31, 60, 61)
- 15** Front panel display (11)
- 16** 📶 (remote sensor) (17)

Front Panel Display

When playing back a DVD

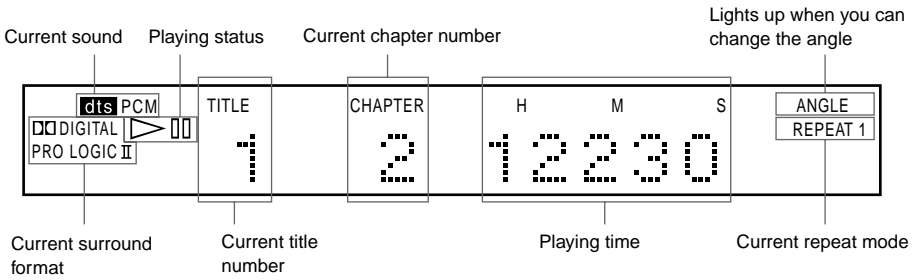

When playing back a Super Audio CD, CD, VIDEO CD, or MP3

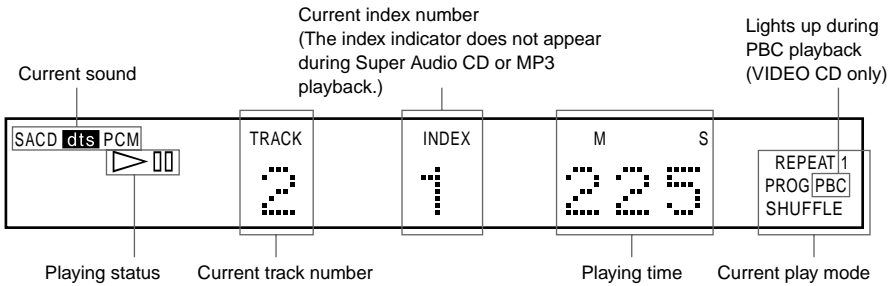

When listening to the radio

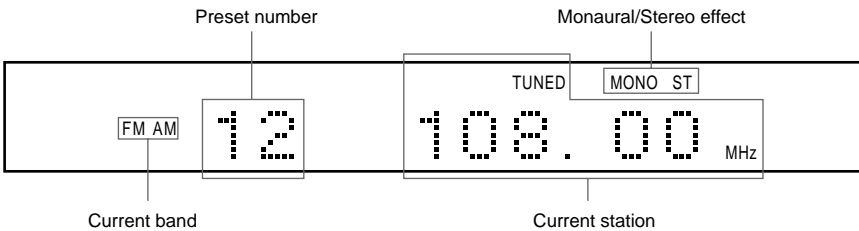

Rear Panel

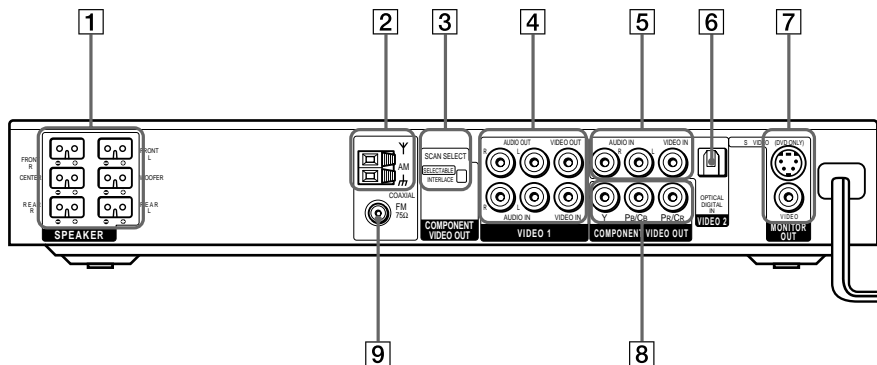

1 SPEAKER jacks (18)

2 AM antenna (20)

3 COMPONENT VIDEO OUT/SCAN
SELECT switch (67, 72)

4 VIDEO 1 jacks (22)

5 VIDEO 2 jacks (22)

6 DIGITAL IN (OPTICAL) jack (23)

7 MONITOR OUT (VIDEO/S VIDEO)
jacks (22)

8 COMPONENT VIDEO OUT jacks (22)

9 FM 75Ω COAXIAL antenna jack (20)

Remote

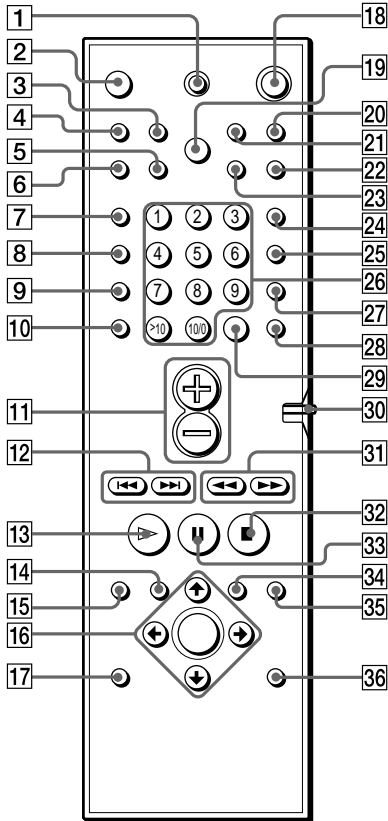

Note

This remote control glows in the dark. However, before glowing, the remote must be exposed to light for awhile.

- 1 TV I/⏻ (on/standby) (59)
- 2 ▲ (EJECT) (31)
- 3 NAME (62)
- 4 STEREO/MONO (61)
- 5 MEMORY (29)
- 6 CLEAR (36, 38, 39, 41)
- 7 PLAY MODE (36, 38, 39)
- 8 AUDIO (46)
- 9 ANGLE (52)
- 10 SUBTITLE (53)
- 11 VOL +/- (59, 61)
- 12 ◀▶/▶▶/◀◀ PREV/NEXT, TV CH -/+, PRESET -/+ (29, 34, 59, 61)
- 13 ▷ PLAY/SELECT (31, 34, 36, 38, 39, 40)
- 14 DVD TOP MENU (33)
- 15 DVD DISPLAY (35, 39, 41, 44, 46, 52, 53)
- 16 ◀/↑/↓/▶/ENTER (25, 29, 33, 34, 36, 39, 41, 46, 51, 52, 53, 62)
- 17 DVD SETUP (55, 64)
- 18 ⏻ (standby) (29, 31, 61)
- 19 DIMMER (28)
- 20 TV/VIDEO (59)
- 21 REPEAT (36, 39)
- 22 MUTING (32)
- 23 TIME (43, 44)
- 24 FUNCTION (31, 60, 61, 62)
- 25 BAND (29)
- 26 Number buttons (33, 34, 36, 41, 52, 59)
- 27 SOUND FIELD (48, 51)
- 28 DISPLAY (61)
- 29 ENTER (59)
- 30 COMMAND MODE DVD TV switch (59)
- 31 ◀◀/▶▶/◀◀▶▶ SLOW, TUNING -/+ (29, 40, 61)
- 32 ■ STOP (31, 34, 54)
- 33 || PAUSE (32)
- 34 DVD MENU (33)
- 35 ↻ RETURN (34, 35, 54)
- 36 AMP MENU (25, 51)

Guide to the Control Menu Display





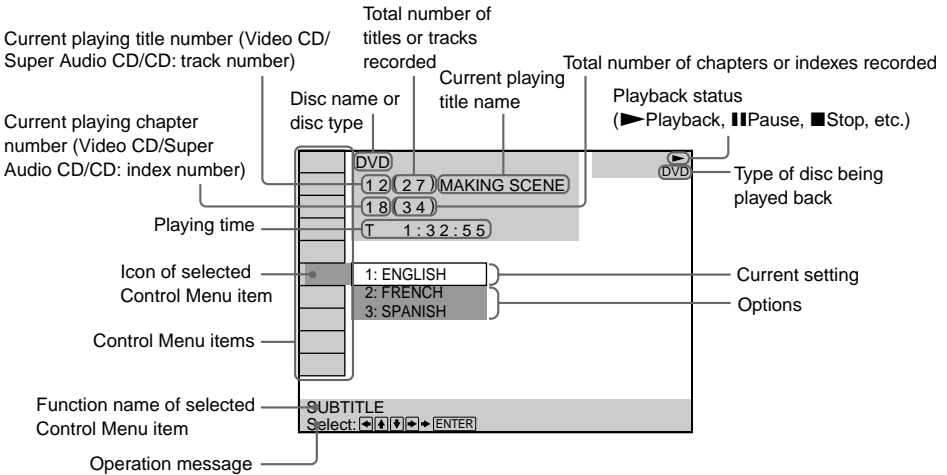

Use the Control Menu to select a function that you'd like to use. The Control Menu display appears when the DVD DISPLAY button is pressed. For details, refer to the page in parentheses.

Control Menu



List of Control Menu Items

DISC	Displays the disc name or the disc type inserted into the system.
TITLE (DVD only) (page 41)/ SCENE (only VIDEO CD in PBC playback) /TRACK (VIDEO CD only) (page 41)	Selects the title (DVD), the scene (VIDEO CD in PBC playback), or the track (VIDEO CD) to be played.
CHAPTER (DVD only) (page 42)/INDEX (VIDEO CD only) (page 42)	Selects the chapter (DVD) or the index (VIDEO CD) to be played.
ALBUM (MP3 only) (page 35, 41)	Selects the album (MP3) to be played.
TRACK (Super Audio CD/ CD/MP3 only) (page 35, 41)	Selects the track (Super Audio CD/CD/MP3) to be played.
INDEX (Super Audio CD/CD only) (page 42)	Displays the index and selects the index (Super Audio CD) to be played.
TIME (page 42)	Checks the elapsed time and the remaining playback time. Inputs the time code for picture and music searching.

 AUDIO (DVD/VIDEO CD/ Super Audio CD/CD only) (page 46)	Changes the audio setting.
 SUBTITLE (DVD only) (page 53)	Displays the subtitles. Changes the subtitle language.
 ANGLE (DVD only) (page 52)	Changes the angle.
 PLAYMODE (VIDEO CD/ Super Audio CD/CD/MP3 only) (page 38)	Selects the play mode.
 REPEAT (page 39)	Plays the entire disc (all titles/all tracks), one title/chapter/track/album, or contents of program repeatedly.
 CUSTOM PARENTAL CONTROL (page 54)	Sets the disc to prohibit playing.

 Each time you press DVD DISPLAY, the Control Menu display changes as follows:

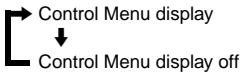

The Control Menu items are different depending on the disc.

 The Control Menu icon indicator lights up in green  →  unless you set the REPEAT setting to “OFF”

The “ANGLE” indicator lights up in green only when the angles can be changed.

Quick Overview

This chapter presents a quick overview so you can begin enjoying your new system right away. For selecting a language used in the on-screen display, refer to the page 65. For selecting the aspect ratio of the TV to be connected, refer to the page 66.

Unpacking

Check that you have the following items:

- Speakers (5)
- Subwoofer (1)
- AM loop antenna (1)
- FM wire antenna (1)
- Speaker cords (5m × 4, 15m × 2) (17ft. × 4, 50ft. × 2)
- Video cord (1)
- Remote Commander (remote) RM-SS880 (1)
- R6 (size AA) batteries (2)
- Foot pads (20)
- Speakers-connection and Installation (card) (1)
- 21-pin Adapter (1) (Only for the European models)

Inserting Batteries into the Remote

You can control the system using the supplied remote. Insert two R6 (size AA) batteries by matching the ⊕ and ⊖ ends on the batteries to the markings inside the compartment. When using the remote, point it at the remote sensor  on the system.

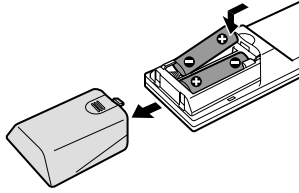

Notes

- Do not leave the remote in an extremely hot or humid place.
- Do not use a new battery with an old one.
- Do not drop any foreign object into the remote casing, particularly when replacing the batteries.
- Do not expose the remote sensor to direct light from the sun or lighting apparatus. Doing so may cause a malfunction.
- If you do not use the remote for an extended period of time, remove the batteries to avoid possible damage from battery leakage and corrosion.

Step 1: Speaker System Hookup

Connect the supplied speaker system using the supplied speaker cords by matching the colors of the terminals to those of the cords. Do not connect any speakers other than those supplied with this system.

To obtain the best possible surround sound, specify the speaker parameters (distance, level, etc.) on page 25.

Required cords

Speaker cords

The connector and the color tube of the speaker cords are the same color as the label of the terminals to be connected.

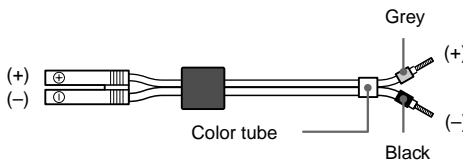

Terminals for connecting the speakers

Connect the	To the
Front speakers	SPEAKER FRONT L (white) and R (red) terminals
Rear speakers	SPEAKER REAR L (blue) and R (grey) terminals
Center speaker	SPEAKER CENTER (green) terminal
Subwoofer	SPEAKER WOOFER (purple) terminal

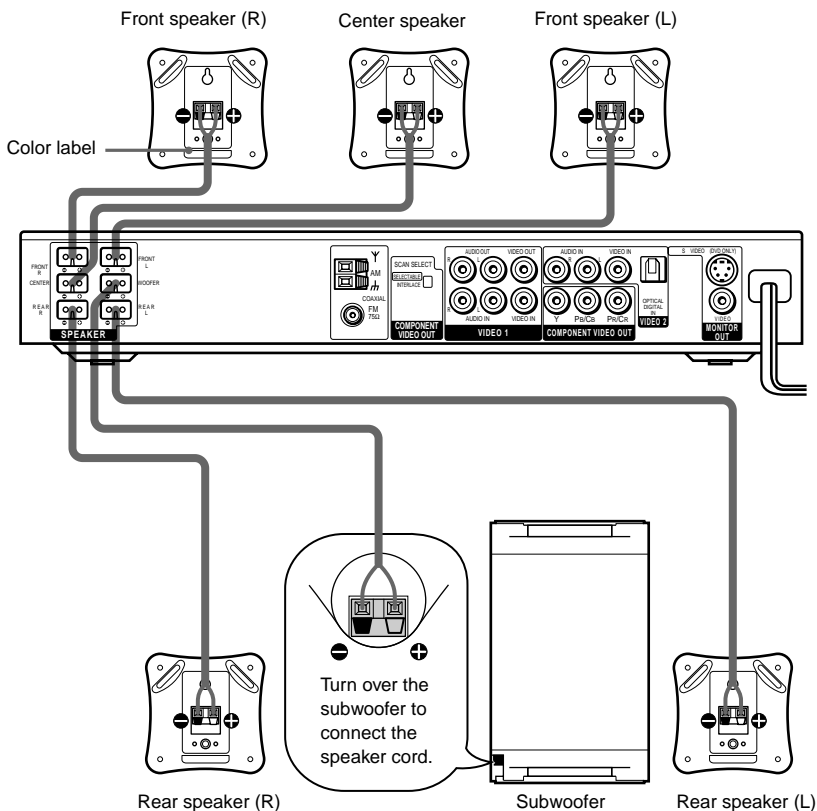

Note on placing speakers

Use caution when placing the subwoofer or a speaker stand (not supplied) that is attached with the front/rear speakers on a specially treated (waxed, oiled, polished, etc.) floor, as staining or discoloration may result.

To avoid short-circuiting the speakers

Short-circuiting of the speakers may damage the system. To prevent this, be sure to follow these precautions when connecting the speakers. Make sure the bare wire of each speaker cord does not touch another speaker terminal or the bare wire of another speaker cord.

Examples of poor conditions of the speaker cord

Stripped speaker cord is touching another speaker terminal.

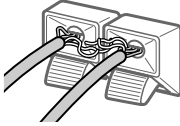

Stripped cords are touching each other due to excessive removal of insulation.

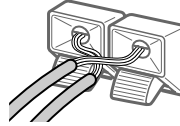

After connecting all the components, speakers, and AC power cord (mains lead), output a test tone to check that all the speakers are connected correctly. For details on outputting a test tone, see page 27.

If no sound is heard from a speaker while outputting a test tone, or a test tone is output from a speaker other than the one currently displayed on the front panel display, the speaker may be short-circuited. If this happens, check the speaker connection again.

Note

Be sure to match the speaker cord to the appropriate terminal on the components: \oplus to \oplus , and \ominus to \ominus . If the cords are reversed, the sound will be distorted and will lack bass.

Step 2: Antenna Hookups

Connect the supplied AM/FM antennas for listening to the radio.

Terminals for connecting the antennas

Connect the	To the
AM loop antenna	AM terminals
FM wire antenna	FM 75Ω COAXIAL terminal

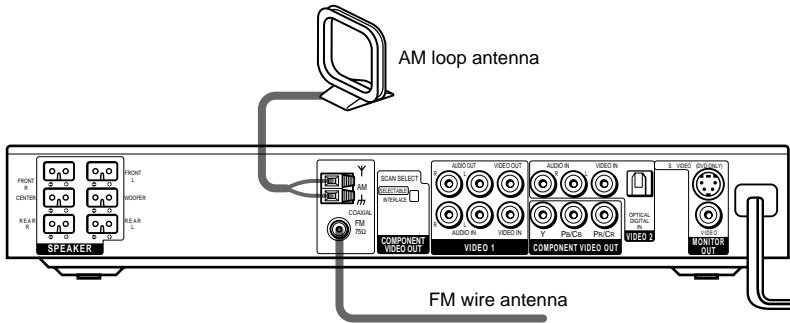

Notes

- To prevent noise pickup, keep the AM loop antenna away from the system and other components.
- Be sure to fully extend the FM wire antenna.
- After connecting the FM wire antenna, keep it as horizontal as possible.
- When you connect the supplied AM loop antenna, connect the black cord (B) to the λ terminal, and the white cord (A) to the other terminal.

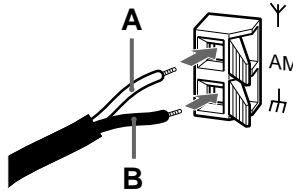

💡 If you have poor FM reception

Use a 75-ohms coaxial cable (not supplied) to connect the system to an outdoor FM antenna as shown below.

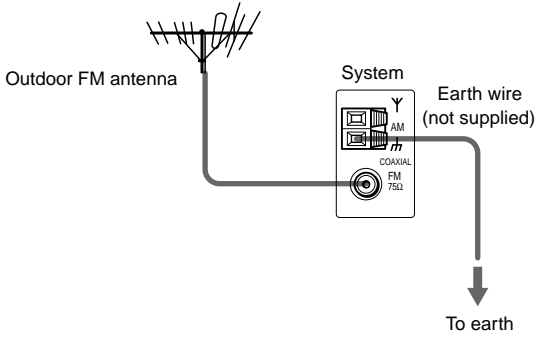

Note

If you connect the system to an outdoor antenna, ground it to protect against lightning. To prevent a gas explosion, do not connect the earth wire to a gas pipe.

Step 3: TV and Video Component Hookups

Required cords

Video cord for connecting a TV monitor



Audio/video cords (not supplied)

When connecting a cord, be sure to match the color-coded pins to the appropriate jacks on the components.

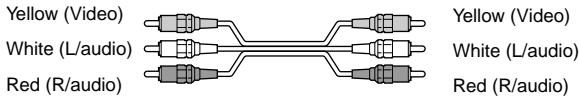

Jacks for connecting video components

Connect a	To the
TV monitor	MONITOR OUT jack
VCR	VIDEO 1 jacks
Digital satellite receiver	VIDEO 2 jacks

When using the S video jack instead of the video jacks

Your TV monitor must also be connected via an S video jack. S video signals are on a separate bus from the video signals and will not be output through the video jacks.

When using the COMPONENT VIDEO OUT jacks (Y, P_B/C_B, P_R/C_R) instead of the video jacks

Your TV monitor must also be connected via COMPONENT VIDEO OUT jacks (Y, P_B/C_B, P_R/C_R). If your TV accept progressive format signals, you must use this connection and set "COMPONENT OUT" to "PROGRESSIVE" in "SCREEN SETUP" (page 67).

Notes

- When you select VIDEO 1 using the FUNCTION button, the signal is output from the front L/R speakers, but not from the VIDEO 1 VIDEO OUT and AUDIO OUT L/R jacks.
- When you use the Video 1 line outputs, please set the unit to 2CH STEREO mode. If the unit is not in 2CH STEREO mode, the line outputs may not function properly.
- When "PROGRESSIVE" is selected in "SCREEN SETUP," no signal is output from the MONITOR OUT or S VIDEO OUT jacks.
- When the mode of the system is set to "DVD," the signal is output from the S VIDEO OUT or COMPONENT OUT jacks.
- When the mode of the system is set to "DVD" and "PROGRESSIVE" is selected in "SCREEN SETUP," the signal is output only from the COMPONENT OUT jacks.

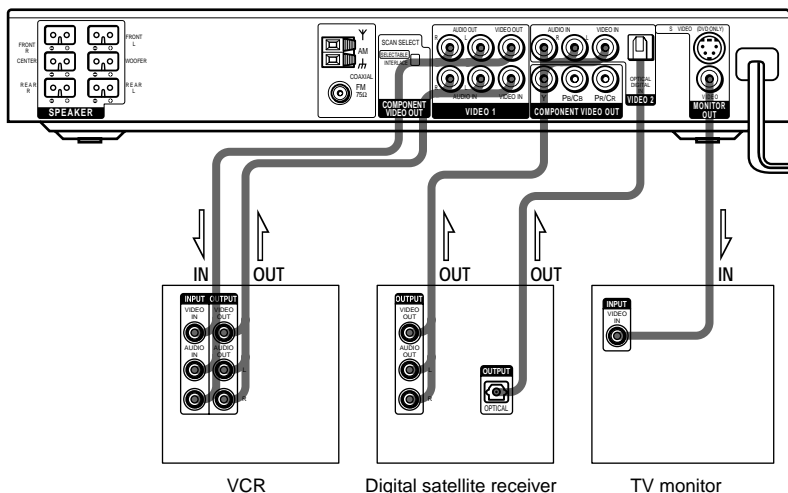

If you connect a digital satellite receiver with the OPTICAL jack

The digital satellite receiver can be connected to the OPTICAL jack instead of the VIDEO IN and AUDIO IN L/R jacks of the system.

The system can accept both the digital and analog signals. Digital signals have priority over analog signals. If the digital signal ceases, the analog signal will be processed after 2 seconds.





If you connect a digital satellite receiver without the OPTICAL jack

Connect the digital satellite receiver to the VIDEO IN and AUDIO IN L/R jacks only of the system.

Setup for the system (for Asian and Australian models)

Setup is necessary for the system, depending on the TV monitor to be connected. The initial setting for Asian models is NTSC but Australian models is PAL.

If the color system of the TV is PAL*

To set the system to PAL, turn on the system by pressing  (power) on the remote while pressing  (pause) button on the system. You need to hold the  button until DAV-S550 appears on the display. To reset to NTSC, turn off the system and then turn on again using the remote while pressing the  button on the system.

* If the color system of the TV is NTSC, do the same operation above to set the system to NTSC.

Connecting the AC Power Cord (mains lead)

Before connecting the AC power cord (mains lead) of this system to a wall outlet (mains), connect the speakers to the system (see page 17).

Connect the AC power cord (mains lead) of your TV/video components to a wall outlet (mains).

Speaker Setup

For the best possible surround sound, all the speakers other than the subwoofer should be the same distance from the listening position (A).

However, this system allows you to place the center speaker up to 1.6 meters (5.0 feet) closer (B) and the rear speakers up to 4.6 meters (15.0 feet) closer (C) to the listening position.

The front speakers can be placed from 1.0 to 15.0 meters (3.0 to 50.0 feet) (A) from the listening position.

You can place the rear speakers either behind you or to the side, depending on the shape of your room, etc.

When the rear speakers are placed to the side

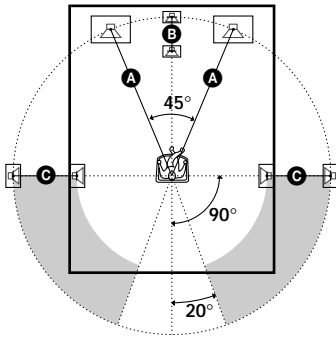

When the rear speakers are placed behind you

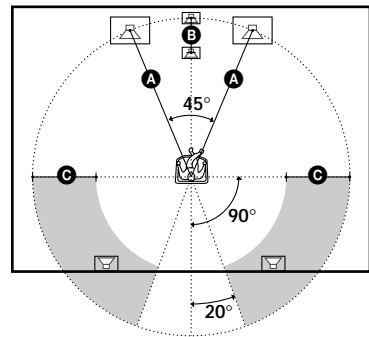

Note

Do not place the center and rear speakers farther away from the listening position than the front speakers.

About magnetically shielded speaker (to prevent color irregularity occurring on the TV screen)

The subwoofer in this system is magnetically shielded to prevent magnetic leakage. However, some leakage may occur, as a high-strength magnet is employed. If the subwoofer is used with a CRT-based TV or projector, install the subwoofer at least 0.3 meters (1.0 ft) from the TV set, etc. If it is installed too close, color irregularity may occur on the screen.

If color irregularity occurs...

Turn off the TV set once, then turn it on after 15 to 30 minutes.

If color irregularity occurs again...

Place the subwoofer farther away from the TV set.

If color irregularity still occurs after performing the above...

Make sure that no magnetic object is nearby the subwoofer. Color irregularity may occur as a result of interaction between the subwoofer and the magnetic object.

Examples of possible sources of magnetic interference include: magnetic latches on a TV stand, etc., healthcare devices, toys, etc.

Specifying the speaker parameters

To obtain the best possible surround sound, first specify the distance of the speakers from your listening position, then set the balance and level. Use the test tone to adjust the speaker volumes to the same level.

You may adjust the speaker parameters using **SPEAKER SETUP** in the setup display (page 69).

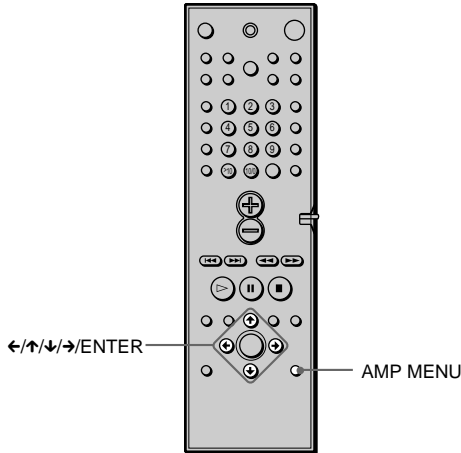

To specify the size, distance, position and height of the speakers

- 1** Press **AMP MENU** repeatedly to display **♪ SP. SETUP** on the front panel display.
- 2** Sit in your listening position and select the item to be set using **↑/↓**.
 - Items set in **♪ SP. SETUP**
 - Size of the rear and center speakers
 - Distance of the front, rear, and center speakers
 - Position and height of the rear speakers
- 3** Set the parameter using **←/→**.
The selected parameter will appear on the front panel display.
- 4** Repeat Steps 2 and 3 to set other parameters in **♪ SP. SETUP**.
If you do not operate the remote for a few seconds, the parameter disappears from the display and is stored in the system.

■ SIZE

When you do not connect center or rear speakers, or move the rear speakers, set the parameters for **CENTER** and **REAR**. Since the front speaker and subwoofer settings are fixed, you cannot change them. The default settings are underlined.

- **CENTER** (center speaker)
 - YES: Normally select this.
 - NO: Select this if no center speaker is used.
- **REAR** (rear speakers)
 - YES: Normally select this. Specify the position and height to implement the Digital Cinema Surround modes.
 - NO: Select this if no rear speaker is used.

■DISTANCE

You can vary the distance of each speaker as follows. The default settings are underlined.

- F. D. 5 m (17 ft) (front speakers distance)

Front speaker distance can be set in 0.2 meters (1.0 foot) steps from 1.0 to 15.0 meters (3.0 to 50.0 feet).

- C. D. 5 m (17 ft) (center speaker distance)

Center speaker distance can be set in 0.2 meters (1.0 foot) steps from a distance equal to the front speaker distance to a distance 1.6 meters (5.0 feet) closer to your listening position.

- R. D. 3.4 m (12 ft) (rear speakers distance)

Rear speaker distance can be set in 0.2 meters (1.0 foot) steps from a distance equal to the front speaker distance to a distance 4.6 meters (15.0 feet) closer to your listening position.

Notes

- If each of the front or rear speakers are not placed an equal distance from your listening position, set the distance of the closest speaker.
- In SPEAKER SETUP, the North American model's OSD displays both metric and imperial measurements. The other model's displays metric measurements only. The manual shows both.

Specifying the rear speaker position and height

If you select anything other than "NO" in "REAR," specify the position and height of the rear speakers. The default settings are underlined.

Position diagram

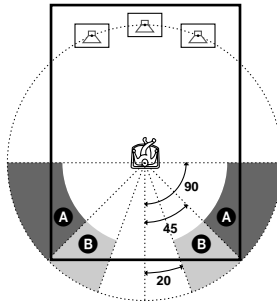

- R. P. BEHIND

Select this if the rear speakers are located in the section **B**.

- R. P. SIDE

Select this if the rear speakers are located in the section **A**.

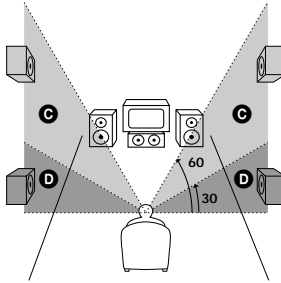

• R. H. LOW

Select this if the rear speakers are located in section **D**.

• R. H. HIGH

Select this if the rear speakers are located in section **C**.

These parameters are not available when “REAR” is set to “NO”.

To specify the balance and level of the speakers

- 1** Press AMP MENU repeatedly to display \downarrow LEVEL on the front panel display.
- 2** Use \uparrow/\downarrow to select T.TONE and use \leftarrow/\rightarrow to set T.TONE to ON.
You will hear the test tone from each speaker in sequence.
- 3** Sit in your listening position and select the item to be adjusted using \uparrow/\downarrow .
 - Items adjusted in \downarrow LEVEL
 - Balance of the front and rear speakers
 - Volume level of the center and rear speakers and subwoofer
- 4** Adjust the volume level so that the volume of the test tone from each speaker sounds the same using \leftarrow/\rightarrow .
The adjusted value will appear on the front panel display.
- 5** Repeat Steps 3 and 4 to adjust other parameters in \downarrow LEVEL.
If you do not operate the remote for a few seconds, the value disappears from the display and is stored in the system.
- 6** Use \uparrow/\downarrow to select T.TONE and use \leftarrow/\rightarrow to set T.TONE to OFF.

■BALANCE

You can vary the balance of each speaker as follows. The default settings are underlined.

- F. ___I___ center (front speakers)
Adjust the balance between the front left and right speakers (You can adjust from center, 6 steps left or right).
- R. ___I___ center (rear speakers)
Adjust the balance between the rear left and right speakers (You can adjust from center, 6 steps left or right).

■LEVEL

You can vary the level of each speaker as follows. The default settings are underlined.

- C. LEVEL (0 dB) (center speaker level)
Adjust the level of the center speaker (You can adjust from -6 dB to +6 dB in 1 dB steps.).
- R. LEVEL (0 dB) (rear speakers level)
Adjust the level of the rear speakers (You can adjust from -6 dB to +6 dB in 1 dB steps.).
- S. W. LEV. (0 dB) (subwoofer level)
Adjust the level of the subwoofer (You can adjust from -6 dB to +6 dB in 1 dB steps.).

Notes

- When you select an item, the sound cuts off for a moment.
- Depending on the settings of other speakers, the subwoofer may output excessive sound.

To adjust the volume of all the speakers at one time

Use the VOLUME control.

Other AMP MENU settings

You can control the brightness of the front panel display, clear the preset stations and the station names, and set the speaker parameters back to the default setting. Press AMP MENU repeatedly to display \downarrow CUSTOMIZE. Use \uparrow/\downarrow to select the following items.

■DIMMER

You can change the brightness of the front panel display by two steps.

■MEMO. CLR.

- N (No): Skip back to previous menu.
- Y (Yes): If you select Y by pressing ENTER, “Really? N” and “Really? Y” appears.
If you select “Really? Y,” by pressing ENTER, “ALL CLEAR!” is displayed and all settings such as preset stations and station names will be cleared, and speaker parameters will be reset to their default settings.

This system incorporates with Dolby Pro Logic II which has movie mode and music mode, and the system can reproduce the 2 channel sound in 5.1 channel through Dolby Pro Logic II.

When the Sound Field is set to “NORMAL SURROUND,” you can select the type of decoding for 2 channel source. Press AMP MENU repeatedly to display \downarrow 2CH MODE. Use \uparrow/\downarrow to select the following items.

■2CH MODE

- PLII MOVIE (Pro Logic II Movie): Performs the Pro Logic II movie mode decoding. This setting is ideal for the movies encoded in Dolby Surround. Besides, this mode can reproduce the sound in 5.1 channel when watching the videos of old movies or in the dubbed language.
- PLII MUSIC (Pro Logic II Music): Performs the Pro Logic II music mode decoding. This setting is ideal for the normal stereo sources, such as CDs.
- PRO LOGIC: Performs the Pro Logic decoding. The source recorded in 2 channel is decoded into 4 channels.

Note

Dolby Pro Logic II does not function for DTS or MPEG format signals or Super Audio CD.

Presetting Radio Stations

You can preset 20 stations for FM and 10 stations for AM.
Before tuning, make sure to turn down the volume to minimum.

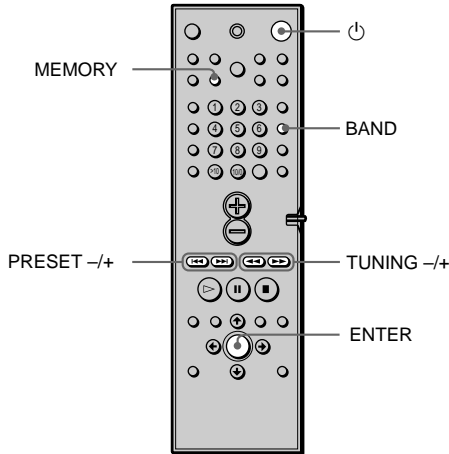

- 1** Press **BAND** repeatedly until the band you want appears on the front panel display.
Every time you press **BAND**, the band changes to AM or FM alternately.
- 2** Press and hold **TUNING +** or **-** until the frequency indication starts to change, then release.
Scanning stops when the system tunes in a station. “TUNED” and “ST” (for stereo program) appear on the front panel display.

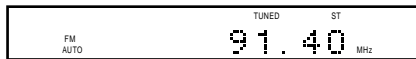

- 3** Press **MEMORY**.
A preset number appears on the front panel display.



- 4** Press **PRESET +** or **-** to select the preset number you want.



5 Press ENTER.

The station is stored.

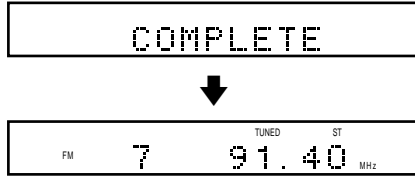

6 Repeat **1** to **5** to store other stations.

To tune in a station with a weak signal



Press TUNING + or – repeatedly in **2** to tune in the station manually.

To change the preset number

Start over from **1**.

To change the AM tuning interval (except for European, Middle Eastern, and Philippine models)

The AM tuning interval is factory set to 9 kHz (10 kHz in some areas).

To change the AM tuning interval, tune in any AM station first, then turn off the system by pressing  on the remote. While holding down  (on the system), turn on the power using the remote. When you change the interval, AM preset stations will be erased.

To reset the interval, repeat the same procedure.

Playing Discs



Depending on the DVD or VIDEO CD, some operations may be different or restricted.

Refer to the operating instructions supplied with your disc.

4 Load a disc.

Push the disc into the disc slot until the disc is retracted automatically.

With the playback side facing down

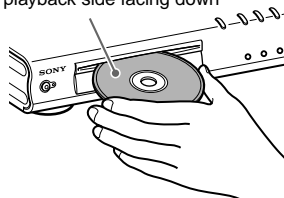



5 Press .

The system starts playback (continuous play). Adjust the volume on the system.



After following Step 5

Depending on the disc, a menu may appear on the TV screen. You can play the disc interactively by following the instructions on the menu. DVD (page 33), VIDEO CD (page 34).



To remove the disc

Press  on the system, or  on the remote. Remove the disc after it is ejected from the system. "READY !" appears on the front panel display.

To turn on the system

Press POWER on the system. The system turns on. In standby mode, the system also turns on by pressing  on the system or by pressing .

To turn off the system

Press  on the remote. The system enters standby mode and the STANDBY indicator lights up in red. To turn off the system completely, press POWER on the system. While playing a disc, do not turn off the system by pressing POWER. Doing so may cancel the menu settings. When you turn off the system, first press  to stop playback and then press  on the remote.

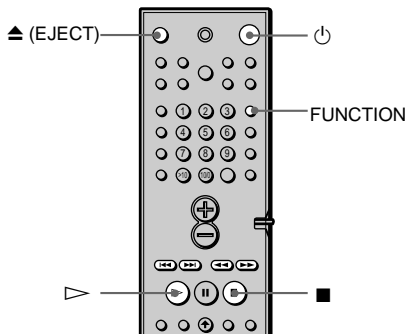
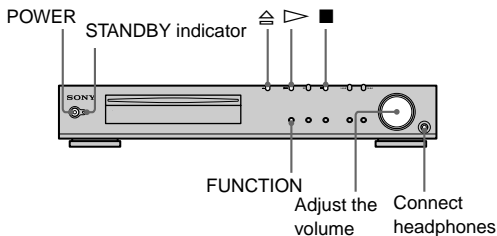

1 Turn on your TV.

2 Switch the input selector on the TV to this system.

3 Press POWER on the system.

The system turns on.

Unless the mode of the system is set to "DVD," press FUNCTION to select "DVD."

Saving the power in standby mode

Press  on the remote once.





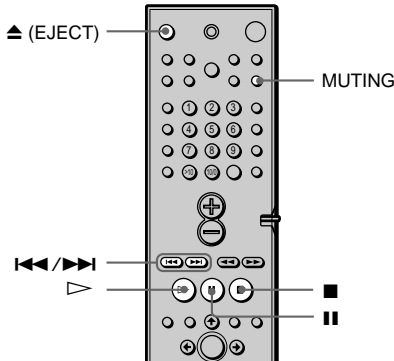

 While the system is in standby mode, the STANDBY indicator on the system lights up.

To cancel standby mode

Press  on the remote once.



Additional operations





To	Operation
Stop	Press  .
Pause	Press  .
Resume play after pause	Press  or  .
Go to the next chapter, track, or scene in continuous play mode	Press  .
Go back to the preceding chapter, track, or scene in continuous play mode	Press  .
Stop play and remove the disc	Press  .
Mute the sound	Press MUTING. To cancel muting, press it again or turn up the volume.

Resuming Playback from the Point Where You Stopped the Disc (Resume Play)



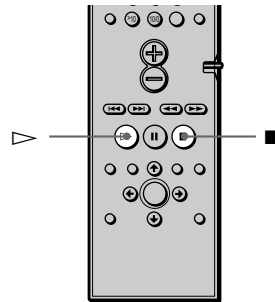

When you stop the disc, the system remembers the point where you pressed  and “RESUME” appears on the front panel display. As long as you do not remove the disc, Resume Play will work even if the system enters standby mode by pressing .



- 1** While playing a disc, press  to stop playback.
“RESUME” appears on the front panel display, so you can restart the disc from the point where you stopped the disc.
If “RESUME” does not appear, Resume Play is not available.

- 2** Press .
- The system starts playback from the point where you stopped the disc in Step 1.

 To play from the beginning of the disc, press  twice, then press .

Notes

- Depending on where you stopped the disc, the system may not resume playback from exactly the same point.
- The point where you stopped playing is cleared when:
 - you turn the power off by pressing **POWER** on the system.
 - you change the play mode.
 - you change the setting on the Setup Menu.

Using the DVD's Menu

DVD

A DVD is divided into long sections of a picture or a music feature called “titles.” When you play a DVD which contains several titles, you can select the title you want using **DVD TOP MENU**.

When you play DVDs that allow you to select items such as the language for the subtitles and the language for the sound, select these items using **DVD MENU**.

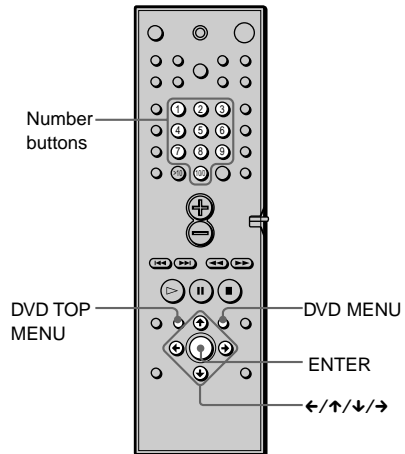

- 1 Press DVD TOP MENU or DVD MENU.**
The disc's menu appears on the TV screen.
The contents of the menu vary from disc to disc.
- 2 Press </>/</> or the number buttons to select the item you want to play or change.**
- 3 Press ENTER.**

Playing VIDEO CDs with PBC Functions (PBC Playback)



With PBC (Playback Control) functions, you can enjoy simple interactive operations, search functions, and other such operations. PBC playback allows you to play VIDEO CDs interactively by following the menu on the TV screen.

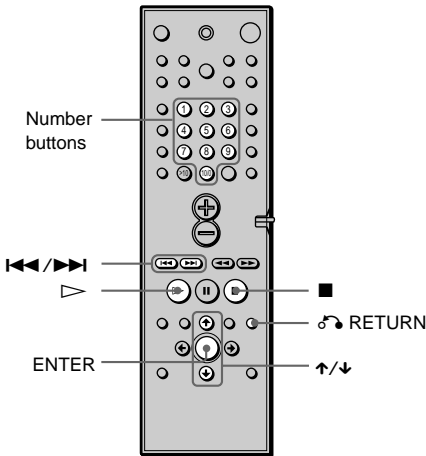

To go back to the menu

Press RETURN.

To play without using PBC, press / or the number buttons while the system is stopped to select a track, then press or ENTER. “Play without PBC” appears on the TV screen and the system starts continuous play. You cannot play still pictures such as a menu. To return to PBC playback, press twice, then press .

Note

Depending on the VIDEO CD, “Press ENTER” in Step 3 may appear as “Press SELECT” in the instructions supplied with the disc. In this case, press .

1 Start playing a VIDEO CD with PBC functions.

The menu for your selection appears.

2 Select the item number you want by pressing / or the number buttons.

3 Press ENTER.

4 Follow the instructions in the menu for interactive operations. Refer to the instructions supplied with the disc, as the operating procedure may differ according to the VIDEO CD.

Playing an MP3 Audio Track

MP3

You can play back data CDs (CD-ROMs/CD-Rs/CD-RWs) recorded in MP3 (MPEG1 Audio Layer 3) format.

1 Load a data disc recorded in MP3 into the system.

2 Press \blacktriangleright .
The system starts to play the first MP3 audio track in the first album on the disc.

Note

The player can play MP3 audio tracks recorded in the following sampling frequencies: 32 kHz, 44.1 kHz, 48 kHz.

Selecting an album and track

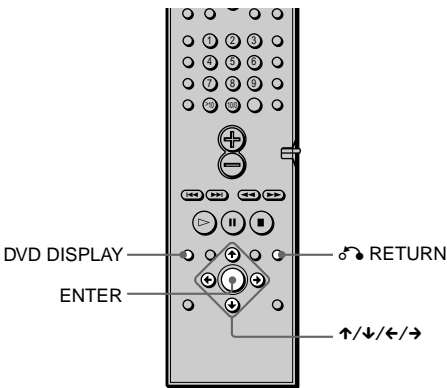

1 Press DVD DISPLAY.
The Control Menu and disc name of MP3 data disc appear.

2 Press \uparrow/\downarrow to select  (ALBUM) then press ENTER or \rightarrow .
The list of albums contained in the disc appears.



3 Select an album you want to play using \uparrow/\downarrow and press ENTER.

4 Select  (TRACK) using \uparrow/\downarrow and press ENTER.
The list of tracks contained in the current album appears.

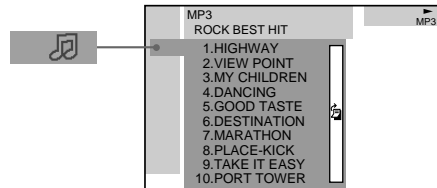

When the list of all tracks or albums cannot be displayed on the window, the jump bar appears. Press \rightarrow to select the jump bar icon, and then scroll the jump bar to display the rest of the list using \uparrow/\downarrow .

5 Select a track using \uparrow/\downarrow and press ENTER.
The Selected track starts playing.

To return to the previous display
Press  RETURN or \leftarrow .

To turn off the display
Press DVD DISPLAY.

Notes

- Only the letters in the alphabet and numbers can be used for album or track names. Anything else is displayed as “ ”.
- If the MP3 file you play back has an ID3 tag, the ID3 tag information is displayed as a track name.

About MP3 audio tracks

You can play MP3 audio tracks on CD-ROMs, CD-Rs, or CD-RWs. However, the discs must be recorded according to ISO9660 level 1, level 2, or Joliet format for the system to recognize the tracks. You can also play discs recorded in Multi Session. See the instructions of the CD-R/RW device or recording software (not supplied) for details on the recording format.

To play a Multi Session CD

This system can play Multi Session CDs when an MP3 audio track is located in the first session. Any subsequent MP3 audio tracks, recorded in the later sessions, can also be played back.

When audio tracks and images in music CD format or video CD format are recorded in the first session, only the first session will be played back.

Notes

- If you put the extension “.MP3” to data not in MP3 format, the system cannot recognize the data properly and will generate a loud noise which could damage your speaker system.
- The system cannot play audio tracks in MP3PRO format.

Creating Your Own Program (Program Play)



You can play the contents of a disc in the order you want by arranging the order of the tracks on the disc to create your own program. You can program up to 25 tracks.

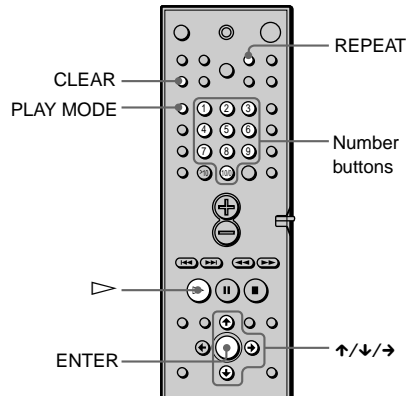

- 1 In stop mode, press PLAY MODE repeatedly until “PROGRAM” appears on the front panel display.

The program menu appears on the TV screen.

Program	Total Time: 0:12:34
1	
2	
3	
4	
5	
6	
7	
8	
9	
10	

2 Press →.

The cursor moves to the track (in this case, “1”). Before programming the MP3 tracks, it is required to select the album.

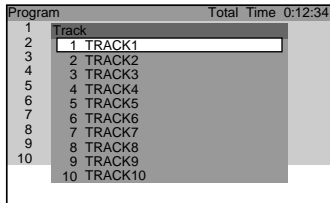

When the list of all tracks or albums cannot be displayed on the window, the jump bar appears. Press → to select the jump bar icon, and then scroll the jump bar to display the rest of the list using ↑/↓.

3 Select the track you want to program.

For example, select track “7.”

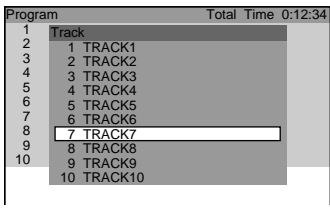

4 Press ↑/↓ or the number buttons to select “7” then press ENTER.

Total time of the programmed tracks (except MP3)

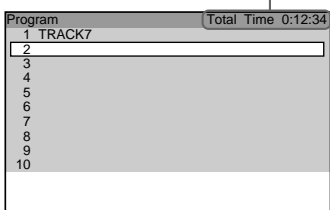

5 To program other tracks, repeat Steps 2 to 4.

The programmed tracks are displayed in the selected order.

6 Press ▷ to start Program Play.

Program Play begins. When the program ends, you can restart the same program again by pressing ▷.

To return to normal play

Press CLEAR during playback.

To turn off the program menu

In stop mode, press PLAY MODE to turn off the program menu.

To cancel the programmed order

Press CLEAR in Step 2, and the last program is canceled one by one.

You can do Repeat Play of the programmed tracks. Press REPEAT, or set “REPEAT” to “ALL” in the Control Menu display during Program Play.

Notes

- This Program Play function is not available for DVDs.
- When you program MP3 tracks, “-:-:--” is displayed as the total time of the programmed tracks.

Playing in random order

(Shuffle Play) VIDEO CD SA-CD CD MP3

You can have the system “shuffle” tracks and play them in random order. Subsequent “shuffling” may produce a different playing order.

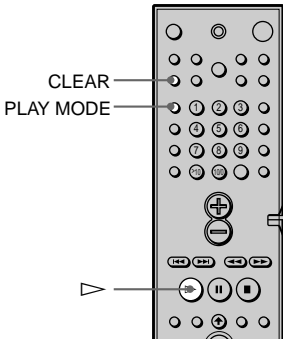

- 1 In stop mode, press PLAY MODE repeatedly until “SHUFFLE” appears on the front panel display.

When you play an MP3 disc, you can play all tracks in Albums in a random order.

- 2 Press ▷.

To return to normal play

In stop mode, press PLAY MODE three times to cancel SHUFFLE or twice to cancel SHUFFLE (ALBUM). Or during playback, press CLEAR to return to normal play.

Note

Shuffle Play is cancelled when:

- you eject the disc.
- you turn the power off.
- you change the function.

Setting the shuffle mode on the Control Menu

You can select the normal shuffle and album shuffle (MP3 only).

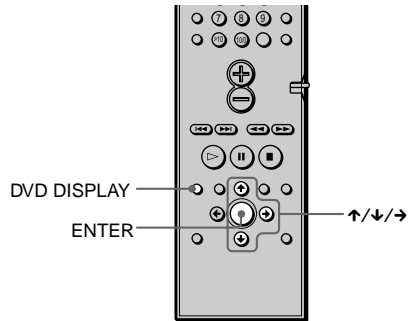

- 1 Press DVD DISPLAY. The Control Menu appears.
- 2 Press ↑/↓ to select **PLAY MODE** (PLAY MODE), then press ENTER or →.

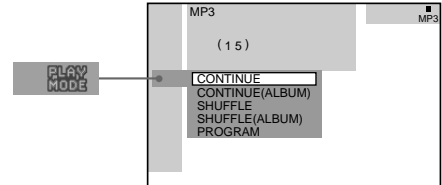

- 3 Select SHUFFLE or SHUFFLE (ALBUM) using ↑/↓ and press ENTER.
- 4 Press ▷. The selected shuffle play begins.

Playing repeatedly (Repeat Play)

(DVD) (VIDEO CD) (SA-CD CD) (MP3)

You can play all the titles/tracks or a single title/chapter/track on a disc.

In Shuffle or Program Play mode, the system repeats tracks in the shuffled or programmed order.

You cannot perform Repeat Play during PBC playback of VIDEO CDs (page 34).

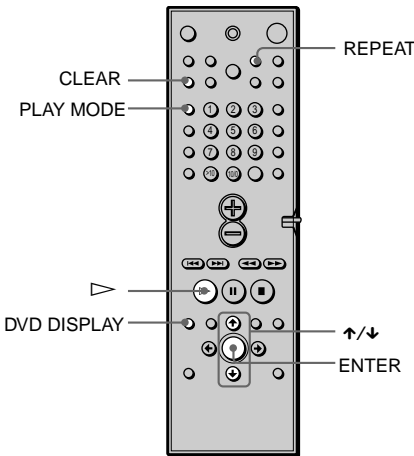

1 Press DVD DISPLAY.
The Control Menu appears.

2 Press \uparrow/\downarrow to select  (REPEAT), then press ENTER.
If you do not select "OFF," the indicator of the "REPEAT" lights in green.

3 Select the Repeat Play setting.

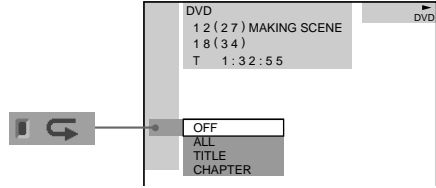

When playing a DVD

- **OFF:** does not play repeatedly.
- **ALL:** repeats all the titles.
- **TITLE:** repeats the current title on a disc.
- **CHAPTER:** repeats the current chapter.

When playing a VIDEO CD/Super Audio CD/CD/MP3 and when Program Play is set to OFF

- **OFF:** does not play repeatedly.
- **ALL:** repeats all the tracks on the disc, or repeats the current album (MP3 only).
- **TRACK:** repeats the current track.

When Program Play is set to ON

- **OFF:** does not play repeatedly.
- **ALL:** repeats Program Play.

To cancel Repeat Play

Press CLEAR.

You can set Repeat Play during stop mode

After selecting the "REPEAT" item, press \triangleright .
The system starts Repeat Play.

You can quickly display the "REPEAT" status

Press REPEAT on the remote.

Notes

- Repeat Play is cancelled when:
 - you eject the disc.
 - you turn the power off.
 - you change the function.
- You can perform Repeat Play for DVD titles that contain chapters.

Searching for a Particular Point on a Disc (Scan, Slow-

motion Play)



You can locate a particular point on a disc quickly by monitoring the picture or playing back slowly.

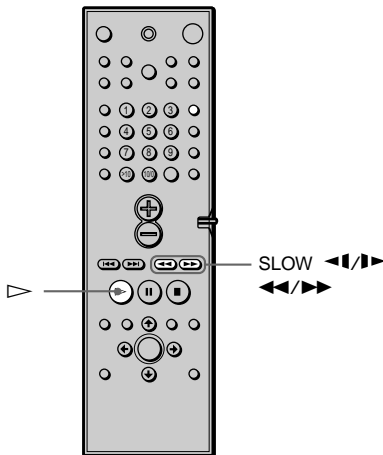

Notes

- Depending on the DVD/VIDEO CD, you may not be able to do some of the operations described.
- This function does not work when you play an MP3 disc.

Locating a point quickly by playing a disc in fast forward or fast reverse (Scan)

Press ◀◀ or ▶▶ while playing a disc. When you find the point you want, press ▷ to return to normal speed.

To change the scan speed (DVD/VIDEO CD/Super Audio CD only)

Each time you press ◀◀ or ▶▶ during scan, the playback speed changes. Two speeds are available. With each press, the indication changes as follows:

Playback direction

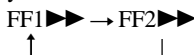

Opposite direction

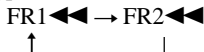

The FF2▶▶/FR2◀◀ playback speed is faster than FF1▶▶/FR1◀◀.

Watching frame by frame (Slow-motion play) DVD VIDEO CD

You can use this function only for DVDs or VIDEO CDs. Press ◀◀ or ▶▶ when the system is in the pause mode. To return to normal speed, press ▷.

Each time you press ◀◀ or ▶▶ during Slow-motion play, the playback speed changes. Two speeds are available. With each press, the indication changes as follows:

Playback direction

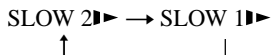

Opposite direction (DVD only)

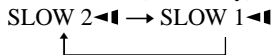

The SLOW 2▶▶/SLOW 2◀◀ playback speed is slower than SLOW 1▶▶/SLOW 1◀◀.

Searching for a Title/ Chapter/Track/Index/ Album



You can search a title (DVD), chapter (DVD), track (CD, VIDEO CD, Super Audio CD, MP3), index (VIDEO CD, Super Audio CD), and album (MP3). As titles, tracks and albums are assigned unique names on the disc, you can select the desired one from the Control Menu. Also chapters and indexes are assigned unique numbers on the disc, so you select the desired one by entering its number. Or you can search a particular point using the time code. (TIME SEARCH)

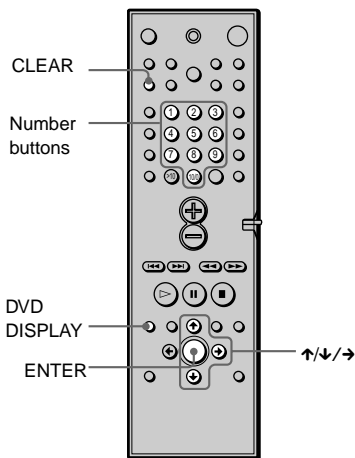

Searching for a title/track/album

- 1 Press DVD DISPLAY.
The Control Menu appears.
- 2 Press \uparrow/\downarrow to select the search method, then press ENTER.

■ When playing a DVD



■ When playing a VIDEO CD

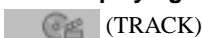

■ When playing a Super Audio CD



■ When playing a CD

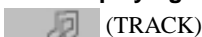

■ When playing an MP3

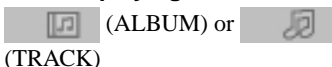

Example: when you select (TRACK)

The list of tracks contained in the disc appears.

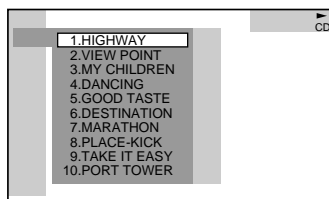

When the list of all tracks or albums cannot be displayed on the window, the jump bar appears. Press \rightarrow to select the jump bar icon, and then scroll the jump bar to display the rest of the list using \uparrow/\downarrow .

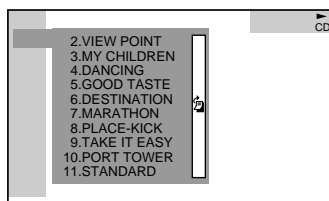

- 3 Press \uparrow/\downarrow to select the desired track, then press ENTER.
The system starts playback from the selected track.

Searching for a chapter/index

- 1 Press DVD DISPLAY.
The Control Menu appears.
- 2 Press \uparrow/\downarrow to select the search method.

■ When playing a DVD

 (CHAPTER)

■ When playing a VIDEO CD

 (INDEX)

■ When playing a Super Audio CD

 (INDEX)

Example: when you select  (CHAPTER)

“** (**)” is selected (** refers to a number).

The number in parentheses indicates the total number of titles, chapters, tracks, or indexes.

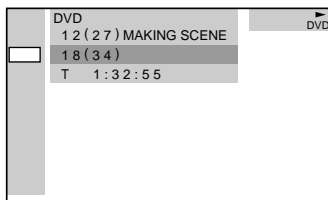

- 3 Press ENTER.
“** (**)” changes to “— (**)”.

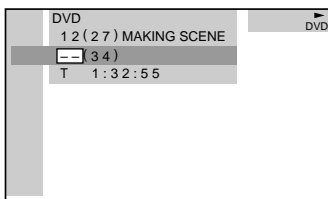

- 4 Press \uparrow/\downarrow or the number buttons to select the chapter or index number you want to search.

If you make a mistake

Cancel the number by pressing CLEAR, then select another number.

- 5 Press ENTER.
The system starts playback from the selected number.

To turn off the Control Menu

Press DVD DISPLAY repeatedly until the Control Menu is turned off.

To search for a particular point using the time code (TIME SEARCH)

- 1 In Step 2, select  (TIME).
“T **:**:**” (playing time of the current title or track) is selected.

- 2 Press ENTER.
“T **:**:**” changes to “T --:--:--”

- 3 Input the time code using the number buttons, then press ENTER.
For example, to find the desired point at 2 hours, 10 minutes, and 20 seconds after the beginning, just enter “2:10:20.”

Notes

- The title, chapter or track number displayed is the same number recorded on the disc.
- You cannot search a scene of a VIDEO CD.

Viewing the Playing Time and Remaining Time on the Front Panel Display



You can check information about the disc, such as the remaining time, total number of titles of a DVD, or tracks of a Super Audio CD, CD, VIDEO CD or MP3, using the front panel display (page 11).



TIME

Press TIME.

Each time you press TIME while playing the disc, the display changes as shown in the following charts.

When playing a DVD

Playing time and number of the current title

TITLE	CHAPTER	H	M	S
1	2	10	3	24

Remaining time of the current title

TITLE	CHAPTER	H	M	S
1	2	-	11	53.6

Playing time and number of the current chapter

CHAPTER	H	M	S
2	02	23	0

Remaining time of the current chapter

CHAPTER	H	M	S
2	-	01	32.0

Title name

SONY HITS/

When playing a VIDEO CD (without PBC functions), Super Audio CD or CD

Playing time and current track number

TRACK	INDEX	M	S
2	1	22	5

Remaining time of the current track

TRACK	INDEX	M	S
2	1	-	15.0

Playing time of the disc

M	S
32	12

Remaining time of the disc

M	S
-	20.18

Track name

SONY HITS/

When playing an MP3

Playing time and current track number

2 225

Remaining time of the current track

2 -150

Track (file) name

VIEW POINT

Album (folder) name

SONY HITS/

Notes

- ID3 tag applies only to version 1.
- If the MP3 file you play back has an ID3 tag, the ID3 tag information is displayed as a track (file) name.
- The ID3 tag character codes comply with ASCII and ISO standards. Joliet format discs can only be displayed in ASCII. Incompatible characters will be displayed as “ ”.
- In the following cases, elapsed playing time and time of the track remaining may not be displayed accurately.
 - when an MP3 file of VBR (variable bit rate) is played.
 - during fast-forward/reverse.

💡 When playing VIDEO CDs with PBC functions, the scene number and the playing time are displayed.

💡 The playing time and remaining time of the current chapter, title, track, scene, or disc will also appear on your TV screen. See the following section “Checking the Playing Time and Remaining Time” for instructions on how to read this information.

Notes

- While playing Super Audio CD, the index indicator does not appear on the front panel display.
- Depending on the type of disc being played and the playing mode, the disc information may not be displayed.

Checking the Playing Time and Remaining Time

DVD VIDEO SA-CD CD MP3

You can check the playing time and remaining time of the current title, chapter, or track, and the total playing time or remaining time of the disc. You can also check the DVD/CD/Super Audio CD text and MP3 folder name/file name/ID3 tag (only song title) recorded on the disc.

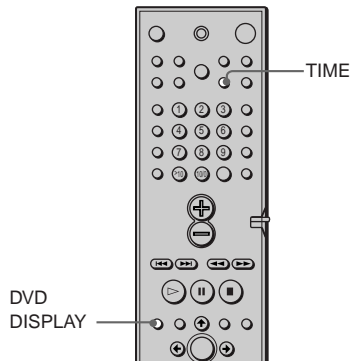

1 Press DVD DISPLAY during playback.

The Control Menu appears.

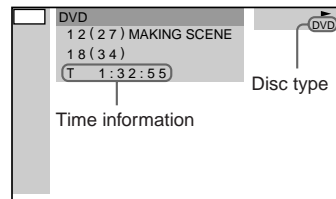

2 Press TIME repeatedly to change the time information.

The display and the kinds of time that you can change depend on the disc you are playing.

■ When playing a DVD

- T **:**:**
Playing time of the current title
- T- **:**:**
Remaining time of the current title
- C **:**:**
Playing time of the current chapter
- C- **:**:**
Remaining time of the current chapter

**■ When playing a VIDEO CD
(with PBC functions)**

- **:**:**
Playing time of the current scene

**■ When playing a VIDEO CD
(without PBC functions), Super
Audio CD or CD**

- T **:**:**
Playing time of the current track
- T- **:**:**
Remaining time of the current track
- D **:**:**
Playing time of the current disc
- D- **:**:**
Remaining time of the current disc

■ When playing an MP3

- T **:**:**
Playing time of the current track
- T- **:**:**
Remaining time of the current track

To turn off the Control Menu

Press DVD DISPLAY repeatedly until the Control Menu is turned off.

Notes

- Only letters of the alphabet can be displayed.
- Depending on the type of disc being played, the system can only display a limited number of characters. Also, depending on the disc, all text characters are not displayed.

Changing the Sound



If a DVD is recorded with multilingual tracks, you can select the language you want while playing the DVD.

If the DVD is recorded in multiple audio formats (PCM, Dolby Digital, MPEG audio, or DTS), you can select the audio format you want while playing the DVD.

With stereo CDs or VIDEO CDs, you can select the sound from the right or left channel and listen to the sound of the selected channel through both the right and left speakers. (In this case, the sound loses its stereo effect.)

For example, when playing a disc containing a song with the vocals on the right channel and the instruments on the left channel, you can select the left channel and hear only the instruments from both speakers.

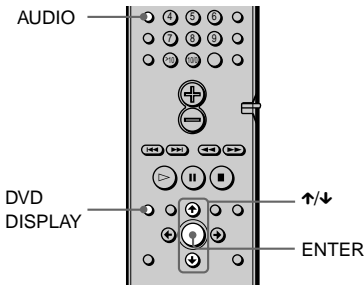

1 Press **DVD DISPLAY** during playback. The Control Menu is displayed.

2 Press **↑/↓** to select **(AUDIO)**, then press **ENTER**. The options for **AUDIO** appear.

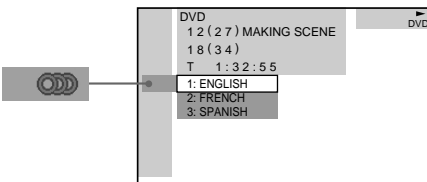

3 Press **↑/↓** to select the desired audio signal.

■ When playing a DVD

Depending on the DVD, the choice of language varies.

When 4 digits are displayed, they represent the language code. Refer to the language code list on page 81 to see which language the code represents. When the same language is displayed two or more times, the DVD is recorded in multiple audio formats.

■ When playing a VIDEO CD, or CD

The default setting is underlined.

- STEREO: The standard stereo sound
- 1/L: The sound of the left channel (monaural)
- 2/R: The sound of the right channel (monaural)

■ When playing a Super Audio CD

In stop mode, depending on the Super Audio CD, the choice of settings varies.

- MULTI: The disc has multi-channel playback area
- 2CH: The disc has the 2 channel playback area.
- CD: When you want to play the disc as a conventional CD.

Note

Not all discs give you the three choices above when in Super Audio CD playback. It all depends on the layer configuration of the Super Audio CD to be played.

4 Press **ENTER**.

To turn off the Control Menu

Press **DVD DISPLAY** repeatedly until the Control Menu is turned off.

You can select **AUDIO** directly by pressing **AUDIO**. Each time you press the button, the item changes.

Notes

- For discs not in multiple audio format, you cannot change the sound.
- During DVD playback, the sound may change automatically.

Displaying the audio information of the disc

When you select “AUDIO,” the channels being played are displayed on the screen. For example, in Dolby Digital format, multiple signals ranging from monaural to 5.1 channel signals can be recorded on a DVD. Depending on the DVD, the number of recorded channels may differ.

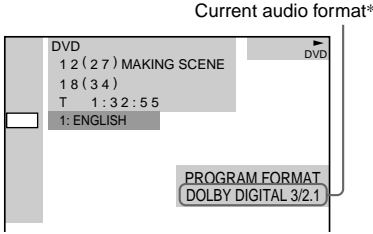

*“PCM,” “MPEG,” “DTS,” or “DOLBY DIGITAL” is displayed.

For “DOLBY DIGITAL,” the channels in the playing track are displayed numerically as follows:

For Dolby Digital 5.1 ch:

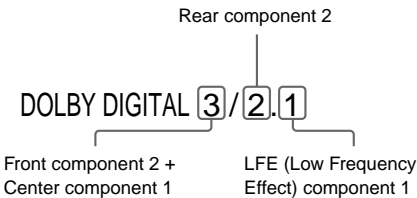

The display examples are as follows:

- PCM (stereo)

PROGRAM FORMAT
PCM 48kHz 24bit

- Dolby Surround

PROGRAM FORMAT
DOLBY DIGITAL 2/0
DOLBY SURROUND

- Dolby Digital 5.1ch

PROGRAM FORMAT
DOLBY DIGITAL 3/2.1

- DTS

PROGRAM FORMAT
DTS 3/2.1

Notes

- When the signal contains rear signal components such as LS, RS, or S, the surround effect is enhanced.
- If you play MPEG AUDIO sound tracks, the system outputs PCM (stereo) signals.

Automatically decoding the input audio signal (Auto Decoding)



The auto decoding function automatically detects the type of audio signal being input (Dolby Digital, DTS, or standard 2 channel stereo) and performs the proper decoding if necessary. This mode presents the sound as it was recorded/encoded, without adding any effects (e.g. reverberation).

However, if there are no low frequency signals (Dolby Digital LFE, etc.), it will generate a low frequency signal for output to the subwoofer.

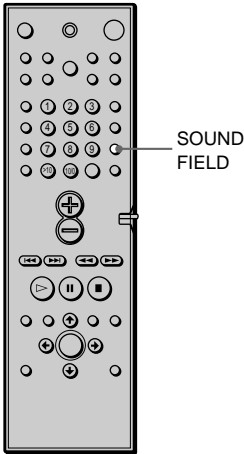

Press **SOUND FIELD -/+** on the system or **SOUND FIELD** on the remote repeatedly until **"AUTO DECO.(AUTO DECODING)"** appears on the front panel display.

The auto format decode function is activated.

Enjoying Surround Sound



You can take advantage of surround sound simply by selecting one of the system's pre-programmed sound fields. They bring the exciting and powerful sound of movie theaters and concert halls into your home. To select the sound field, press **SOUND FIELD -/+** on the system or **SOUND FIELD** on the remote repeatedly until the sound field you want appears on the front panel display.

Sound field	Display
Auto Decoding	AUTO DECO.
Normal surround	N.SURROUND
Cinema Studio EX A	C.S.EX A*
Cinema Studio EX B	C.S.EX B*
Cinema Studio EX C	C.S.EX C*
Hall	HALL
Jazz Club	JAZZ CLUB
Live Concert	L.CONCERT
Game	GAME
2ch Stereo	2CH STEREO

* Use DCS Technology

About DCS (Digital Cinema Sound)

In the collaboration with Sony Pictures Entertainment, Sony measured the sound environment of their studios and integrated the data of the measurement and Sony's own DSP (Digital Signal Processor) technology to develop "Digital Cinema Sound".

"Digital Cinema Sound" simulates in a home theater an ideal movie theater sound environment based on the preference of movie director.

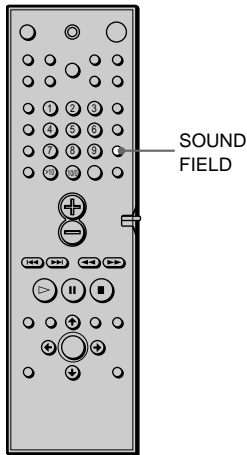

Enjoying movies with Cinema Studio EX

Cinema Studio EX is ideal for enjoying the movie software encoded with multi channel format, such as the Dolby Digital DVD. This mode reproduces the sound characteristics of Sony Pictures Entertainment's studios.

Press **SOUND FIELD +/-** on the system or **SOUND FIELD** on the remote repeatedly until "C.S.EX A (or B, C)" appears on the front panel display.

C.S.EX A (Cinema Studio EX A)

Reproduces the sound characteristics of the Sony Pictures Entertainment "Cary Grant Theater" cinema production studio. This is a standard mode, great for watching most any type of movie.

C.S.EX B (Cinema Studio EX B)

Reproduces the sound characteristics of the Sony Pictures Entertainment "Kim Novak Theater" cinema production studio. This mode is ideal for watching science-fiction or action movies with lots of sound effects.

C.S.EX C (Cinema Studio EX C)

Reproduces the sound characteristics of the Sony Pictures Entertainment scoring stage. This mode is ideal for watching musicals or classic films where music is featured in the soundtrack.

About Cinema Studio EX

Cinema Studio EX consists of the following three elements.

- **Virtual Multi Dimension**
Creates 5 sets of virtual speakers surrounding the listener from a single pair of actual rear speakers.

- **Screen Depth Matching**

In a movie theater, sound seems to come from inside the image reflected on the movie screen. This element creates the same sensation in your listening room by shifting the sound of the front speakers "into" the screen.

- **Cinema Studio Reverberation**

Reproduces the reverberations peculiar to a movie theater.

Cinema Studio EX is the integrated mode which operates these elements simultaneously.

Notes

- The effects provided by the virtual speakers may cause increased noise in the playback signal.
- When listening with sound fields that employ the virtual speakers, you will not be able to hear any sound coming directly from the rear speakers.

Selecting other sound fields

Press **SOUND FIELD +/-** on the system or **SOUND FIELD** on the remote repeatedly until the sound field you want appears on the front panel display.

The current sound field appears on the front panel display.

N. SURROUND (Normal Surround)

Software with multi channel surround audio signals is played back according to the way it was recorded. Software with 2 channel audio signals is decoded with Dolby Pro Logic or Dolby Pro Logic II to create surround effects (page 28).

HALL (Hall)

Reproduces the acoustics of a rectangular concert hall.

JAZZ CLUB (Jazz Club)

Reproduces the acoustics of a jazz club.

L. CONCERT (Live Concert)

Reproduces the acoustics of a 300-seat live concert.

GAME (Game)

Obtains maximum audio impact from video game software.

HP. THEATER (Headphone Theatre)

When you connect your headphone to the PHONES jack of the system, the HEADPHONE THEATER mode allows you to experience a theatre like environment while listening through a pair of headphones. This mode is very effective with 5.1 ch discrete signal sources like Dolby Digital and DTS. Selecting any Sound Field selections (except AUTO DECODING or 2 CH STEREO) enables the mode.



To turn the surround effect off

Press SOUND FIELD $-/+$ on the system or SOUND FIELD on the remote repeatedly until "AUTO DECO." or "2CH STEREO" appears on the front panel display.

The system memorises the last sound field selected for each function mode (Sound Field Link)

Whenever you select a function such as DVD or TUNER, the sound field that was last applied to the function is automatically applied again. For example, if you listen to DVD with HALL as the sound field, then change to another function, and then return to DVD, HALL will be applied again. With the tuner, sound fields are memorised separately for all preset stations.

You can identify the encoding format of program software by looking at its packaging

- Dolby Digital discs are labelled with the  logo.
- Dolby Surround encoded programs are labelled with the  logo.
- DTS Digital Surround discs are marked with DTS.

Note

When you play sound tracks with 96 kHz sampling frequency, the output signals will be converted to 48 kHz (sampling frequency).

Using only the front speakers and subwoofer

(2 Channel Stereo)

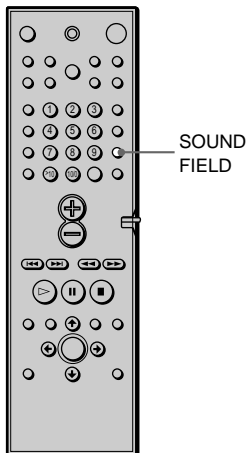

Press **SOUND FIELD -/+** on the system or **SOUND FIELD** on the remote repeatedly until **"2CH STEREO"** appears on the front panel display.

This mode outputs the sound from the front left and right speakers and subwoofer.

Standard two channel (stereo) sources completely bypass the sound field processing. Multi channel surround formats are downmixed to two channels.

This allows you to play any source using only the front left and right speakers and subwoofer.

Adjusting the level parameters



The level menu contains parameters that let you adjust the balance and speaker volumes of each speaker (page 27).

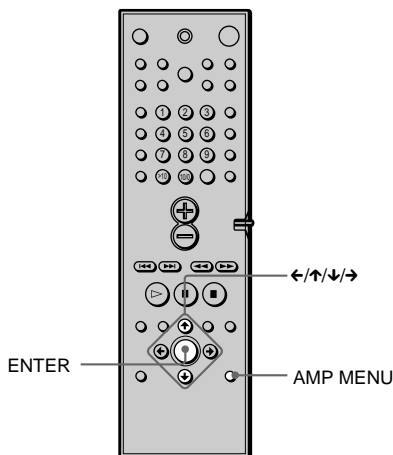

- 1** Start playing a program source encoded with multichannel surround sound.
- 2** Press **AMP MENU** repeatedly. \updownarrow **LEVEL** appears on the front panel display.
- 3** Sit in your listening position and select the item to be adjusted using \updownarrow .
- 4** Adjust the volume level using \leftarrow/\rightarrow .
The adjusted value will appear on the front panel display. If you do not operate the remote for a few seconds, the value turns off and is stored in the system.

Changing the Angles

If various angles (multi-angles) for a scene are recorded on the DVD, “ANGLE” appears in the front panel display. This means that you can change the viewing angle.

For example, while playing a scene of a train in motion, you can display the view from either the front of the train, the left window of the train, or from the right window without having the train’s movement interrupted.

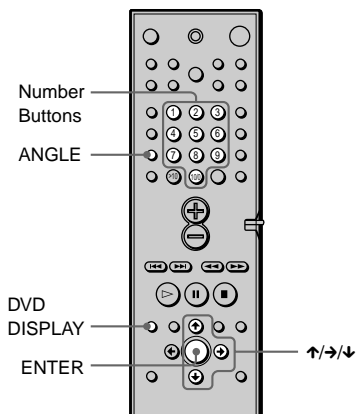

- 1 Press DVD DISPLAY during playback.**

The Control Menu appears.

- 2 Press \uparrow/\downarrow to select  (ANGLE).**

The angle number appears.

The number in parentheses indicates the total number of angles.

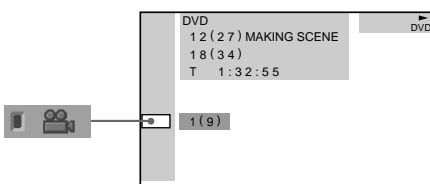

- 3 Press \rightarrow or ENTER.**

The angle number changes to “-.”

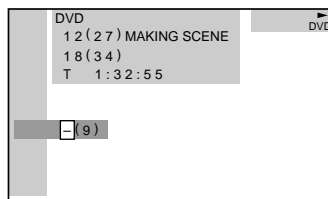

- 4 Select the angle number using the number buttons or \uparrow/\downarrow , then press ENTER.**

The angle is changed to the selected angle.

To turn off the Control Menu

Press DVD DISPLAY repeatedly until the Control Menu is turned off.

 You can select the angle directly by pressing ANGLE. Each time you press the button, the angle changes.

Note

Depending on the DVD, you may not be able to change the angles, even if multi-angles are recorded on the DVD.

Displaying the Subtitles



If subtitles are recorded on the discs, you can turn the subtitles on and off while playing. If multilingual subtitles are recorded on the disc, you can change the subtitle language while playing, or turn the subtitles on or off whenever you want. For example, you can select the language you want to practice and turn the subtitles on for better understanding.

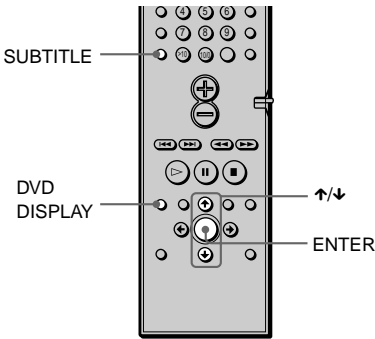

- 1** Press DVD DISPLAY during playback.
The Control Menu appears.

- 2** Press \uparrow/\downarrow to select  (SUBTITLE), then press ENTER.
The options for SUBTITLE appear.

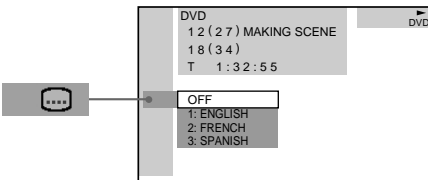

- 3** Press \uparrow/\downarrow to select the language. Depending on the DVD, the choice of language varies.
When 4 digits are displayed, they indicate the language code. Refer to the language code list on page 81 to see which language the code represents.

- 4** Press ENTER.

To cancel the SUBTITLE setting

Select "OFF" in Step 3.

To turn off the Control Menu

Press DVD DISPLAY repeatedly until the Control Menu is turned off.

 You can select SUBTITLE directly by pressing SUBTITLE. Each time you press the button, the item changes.

Note

Depending on the DVD, you may not be able to change the subtitles even if multilingual subtitles are recorded on it.

Locking Discs (CUSTOM PARENTAL CONTROL, PARENTAL CONTROL)

You can set two kinds of playback restrictions for a disc.

- Custom Parental Control

You can set the playback restrictions so that the system will not play inappropriate discs.

- Parental Control

Playback of some DVDs can be limited according to a predetermined level such as the age of the users.

The same password is used for both Parental Control and Custom Parental Control.

Custom Parental Control



You can set the same Custom Parental Control password for up to 25 discs. When you set the 26th disc, the playback restriction of the disc for which you first set the password is canceled.

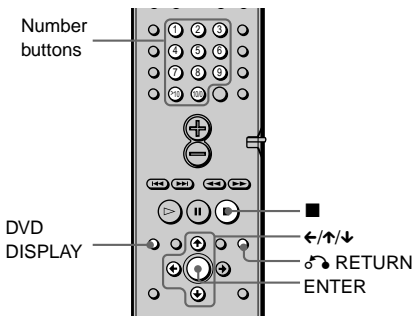

- 1 Insert the disc you want to lock.**
If the disc is playing, press **■** to stop playback.
- 2 In stop mode, press DVD DISPLAY.**
The Control Menu appears.

- 3 Press \uparrow/\downarrow to select **■** (CUSTOM PARENTAL CONTROL), then press ENTER.**
“CUSTOM PARENTAL CONTROL” is selected.

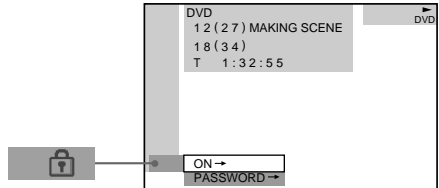

- 4 Press \uparrow/\downarrow to select “ON →,” then press ENTER.**

■When you have not entered a password

The display for registering a new password appears.

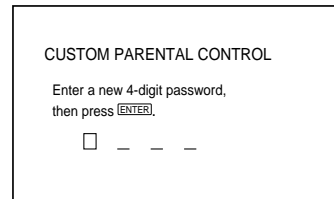

Enter a 4-digit password by using the number buttons, then press ENTER. The display for confirming the password appears.

■When you have already registered a password

The display for entering the password appears.

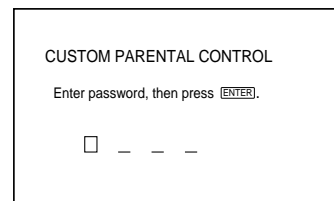

- 5** Enter or re-enter your 4-digit password by using the number buttons, then press ENTER.

“Custom parental control is set.” appears and the screen returns to the Control Menu display.

If you make a mistake entering your password

Press **←** before you press ENTER and input the correct number.

If you make a mistake

Press **↶** RETURN, then start from Step 3 again.

To turn off the Control Menu

Press DVD DISPLAY repeatedly until the Control Menu is turned off.

To turn off the Custom Parental Control function

- 1** In Step 4, select “OFF →,” then press ENTER.
- 2** Enter your 4-digit password using the number buttons, then press ENTER.

To change the password

- 1** In Step 4, press **↑/↓** to select “PASSWORD →,” then press ENTER. The display for entering the password appears.
- 2** Enter your 4-digit password using the number buttons, then press ENTER.
- 3** Enter a new 4-digit password using the number buttons, then press ENTER.
- 4** To confirm your password, re-enter it using the number buttons, then press ENTER.

Playing the disc for which Custom Parental Control is set

- 1** Insert the disc for which Custom Parental Control is set. The CUSTOM PARENTAL CONTROL display appears.

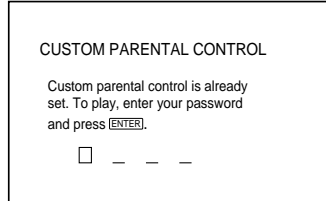

- 2** Enter your 4-digit password using the number buttons, then press ENTER. The system is ready for playback.

💡 If you forget your password, enter the 6-digit number “199703” using the number buttons when the CUSTOM PARENTAL CONTROL display asks you for your password, then press ENTER. The display will ask you to enter a new 4-digit password.

Limiting playback for children (Parental Control) (DVD)

Playback of some DVDs can be limited according to a predetermined level such as the age of the users. The “Parental Control” function allows you to set a playback limitation level.

A scene that is limited is not played, or it is replaced by a different scene.

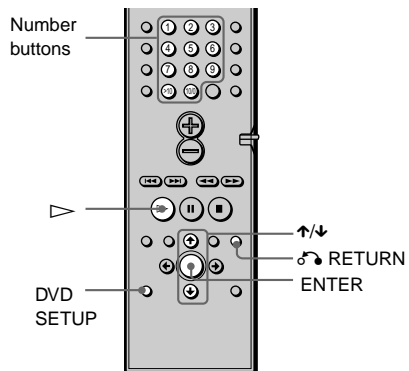

1 In stop mode, press DVD SETUP.
The Setup Display appears.

2 Press \uparrow/\downarrow to select "CUSTOM SETUP,"
then press ENTER.
"CUSTOM SETUP" is displayed.

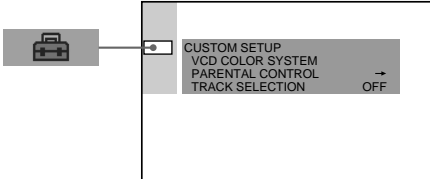

3 Press \uparrow/\downarrow to select "PARENTAL CONTROL →,"
then press ENTER.

■ **If you have not entered a password**

The display for registering a new password appears.

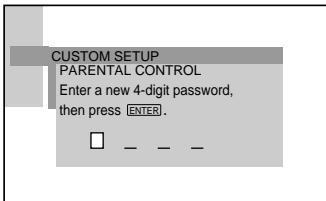

Enter a 4-digit password using the number buttons, then press ENTER.
The display for confirming the password appears.

■ **When you have already registered a password**

The display for entering the password appears.

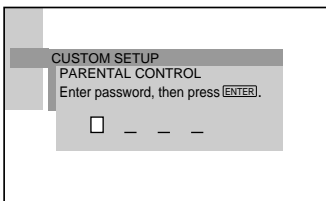

4 Enter or re-enter your password using the number buttons, then press ENTER.
The display for setting the playback limitation level and changing the password appears.

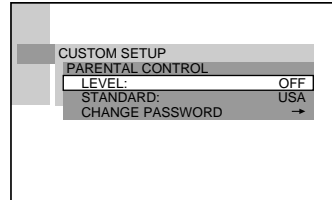

5 Press \uparrow/\downarrow to select "STANDARD," then press ENTER.

The selection items for "STANDARD" are displayed.

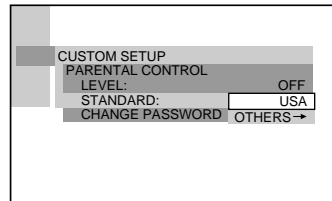

6 Press \uparrow/\downarrow to select a geographic area as the playback limitation level, then press ENTER.

The area is selected.

If you select "OTHERS →," select and enter the standard code in the table on page 58 using the number buttons.

- 7** Press \uparrow/\downarrow to select “LEVEL,” then press ENTER.

The selection items for “LEVEL” are displayed.

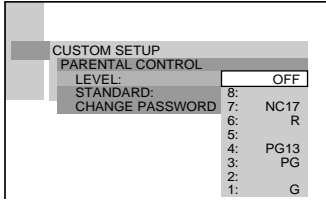

- 8** Select the level you want using \uparrow/\downarrow , then press ENTER.

Parental Control setting is complete.

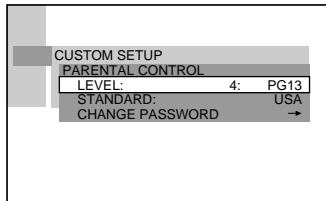

The lower the value, the more strict the limitation.

If you make a mistake

Press \leftarrow RETURN to go back to the previous screen.

To turn off the Setup Display

Press DVD SETUP repeatedly until the Setup Display is turned off.

To turn off the Parental Control function and play the DVD after entering your password

Set “LEVEL” to “OFF” in Step 8.

To change the password

- 1** In Step 5, select “CHANGE PASSWORD \rightarrow ” using \downarrow , then press ENTER.

The display for entering the password appears.

- 2** Follow Step 3 to enter a new password.

Playing the disc for which Parental Control is set

- 1** Insert the disc and press \triangleright .
The PARENTAL CONTROL display appears.
- 2** Enter your 4-digit password using the number buttons, then press ENTER.
The system starts playback.

 If you forget your password, remove the disc and repeat Step 1 to 5 of “Limiting playback for children.” When you are asked to enter your password, enter “199703” using the number buttons, then press ENTER. The display will ask you to enter a new 4-digit password. After you enter a new 4-digit password in Step 3, replace the disc in the system and press \triangleright . When the PARENTAL CONTROL display appears, enter your new password.

Notes

- When you play DVDs which do not have the Parental Control function, playback cannot be limited on this system.
- Depending on the DVD, you may be asked to change the parental control level while playing the disc. In this case, enter your password, then change the level. If the Resume Play mode is cancelled, the level returns to the original level.

Area Code

Standard	Code number	Standard	Code number
Argentina	2044	Korea	2304
Australia	2047	Malaysia	2363
Austria	2046	Mexico	2362
Belgium	2057	Netherlands	2376
Brazil	2070	New Zealand	2390
Canada	2079	Norway	2379
Chile	2090	Pakistan	2427
China	2092	Philippines	2424
Denmark	2115	Portugal	2436
Finland	2165	Russia	2489
France	2174	Singapore	2501
Germany	2109	Spain	2149
Hong Kong	2219	Sweden	2499
India	2248	Switzerland	2086
Indonesia	2238	Taiwan	2543
Italy	2254	Thailand	2528
Japan	2276	United Kingdom	2184

Controlling the TV with the Supplied Remote

By adjusting the remote signal, you can control your TV with the supplied remote.

Notes

- If you enter a new code number, the code number previously entered will be erased.
- When you replace the batteries of the remote, the code number may be reset to the default (SONY) setting. Reset the appropriate code number.

Controlling TVs with the remote

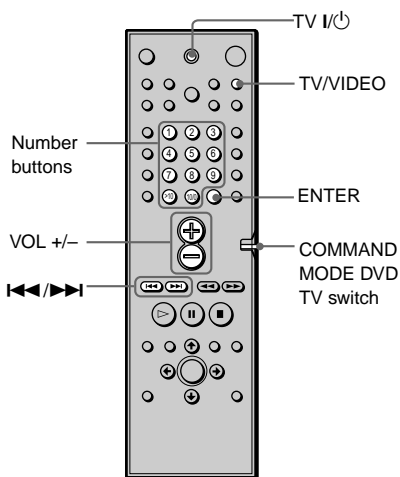

Press and hold TV I/O while entering your TV's manufacturer's code (see the table) using the number buttons and press ENTER. Then release TV I/O.

Code numbers of controllable TVs

If more than one code number is listed, try entering them one at a time until you find the one that works with your TV.

TV

Manufacturer	Code number
SONY	001
DAEWOO	002, 004, 005, 006, 007, 015
FISHER	008
GOLDSTAR	002, 003, 011, 012, 015, 034
GRUNDIG	017, 034
HITACHI	002, 013, 014, 015
ITT/NOKIA	021, 022
JVC	016
MAGNAVOX	002, 003, 018
MITSUBISHI/MGA	002, 003, 019
NEC	002, 003, 020
PANASONIC	009, 024
PHILIPS	015, 018
PIONEER	009, 025, 026, 040
RCA/PROSCAN	002, 010, 027, 028, 029
SAMSUNG	002, 003, 015, 031, 032, 033, 034
SANYO	008, 044, 045, 046
SHARP	035
TELEFUNKEN	023, 036, 037, 038
THOMSON	030, 037, 039
TOSHIBA	035, 040, 041
ZENITH	042, 043

CATV

Manufacturer	Code number
SONY	101
HAMLIN/REGAL	123, 124, 125, 126, 127
JERROLD/GI	102, 103, 104, 105, 106, 107, 108, 109, 119, 131
OAK	128, 129, 130
PANASONIC	120, 121, 122
PIONEER	115, 116
SCIENTIFIC ATLANTA	110, 111, 112
TOCOM	117, 118, 131
ZENITH	113, 114

Controlling the TV

You can control your TV using the buttons below.

By pressing	You can
TV I/O	Turn the TV on or off.
TV/VIDEO	Switch the TV's input source between the TV and other input sources.

Switching between TV and DVD

Using the COMMAND MODE DVD TV switch, you can switch the remote signal between control of the TV and control of the DVD unit. When you watch the DVD, ensure that you have the COMMAND MODE DVD TV switch set to DVD.

The table below shows the buttons that are affected by the COMMAND MODE DVD TV switch.

Button	DVD	TV
1~9,* >10, 10/0	Standard number button function for DVD.	Selects the TV Channels.
ENTER	Standard enter function for DVD.	Confirms the selected channel. Occasionally you may be able to select 12 channel directly.
◀◀	Standard preceding title, chapter skip function for DVD.	TV CH -
▶▶	Standard forward title, chapter skip for DVD.	TV CH +
⊕	VOL +	VOL +
⊖	VOL -	VOL -

Note

Depending on the TV, you may not be able to control your TV or to use some of the buttons above.

* For double digit number, press >10, then the number. (For example, press >10, then 2 and 5 for entering 25.)

Using the Video or other Unit

You can use VCRs or other units connected to the VIDEO 1 or VIDEO 2 jacks. Refer to the operation manual supplied with the unit for further information on the operation.

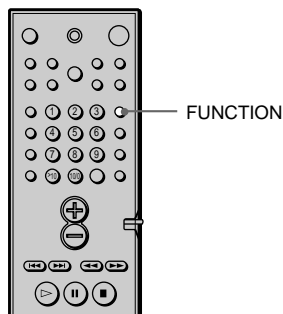

Press **FUNCTION** repeatedly until **VIDEO 1** or **VIDEO 2** that you connected the unit to appears on the front panel display.

Each time you press **FUNCTION**, the mode of the system changes in the following sequence.

DVD → VIDEO 1 → VIDEO 2 →
TUNER → DVD...

Listening to the Radio

Preset radio stations in the system's memory first (see "Presetting Radio Stations" on page 29).

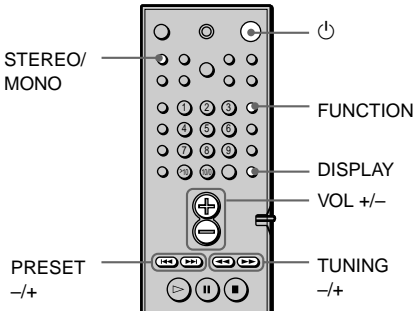

- 1 Press **FUNCTION** repeatedly until **TUNER** appears on the front panel display.

The last received station is tuned in.

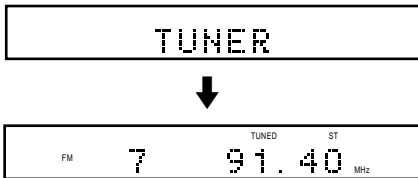

- 2 Press **PRESET +** or **-** repeatedly to select the preset station you want. Each time you press the button, the system tunes in one preset station.

- 3 Adjust the volume by pressing **VOL +/-**.

To turn off the radio

Press .

To listen to non-preset radio stations

Use manual or automatic tuning in Step 2.

For manual tuning, press **TUNING +** or **-** on the remote repeatedly.

For automatic tuning, press and hold **TUNING +** or **-** on the remote.

If an FM program is noisy

Press **STEREO/MONO** on the remote so that "MONO" appears on the front panel display. There will be no stereo effect, but the reception will improve. Press the button again to restore the stereo effect.

To improve reception

Reorient the supplied antennas.

To check the frequency or sound field

Press **DISPLAY** repeatedly.

Each time you press **DISPLAY**, the front panel display changes as follows:
index name of the station* → frequency → sound field → index name of the station.

* This is displayed when you have entered a name for preset stations (page 62).

Using the Radio Data System (RDS)

(Only for the European models)

What is the Radio Data System?

Radio Data System (RDS) is a broadcasting service that allows radio stations to send additional information along with the regular program signal. This tuner offers convenient RDS features such as station name display. RDS is available only for FM stations.*

Note

RDS may not work properly if the station you are tuned to is not transmitting the RDS signal properly, or if the signal strength is weak.

* Not all FM stations provide RDS service, nor do they provide the same type of services. If you are not familiar with the RDS system, check with your local radio stations for details on RDS services in your area.

Receiving RDS broadcasts

Simply select a station from the FM band. When you tune in a station that provides RDS services, the station name appears in the display.

To check the RDS information

Each time you press DISPLAY, the display changes as follows:

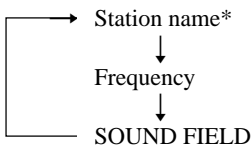

* If the RDS broadcast is not received, the station name may not appear in the display.

Naming Preset Stations

You can enter a name of up to 8 characters for preset stations. These names (for example, “XYZ”) appear in the system’s front panel display when a station is selected.

Note that no more than one name can be entered for each preset station.

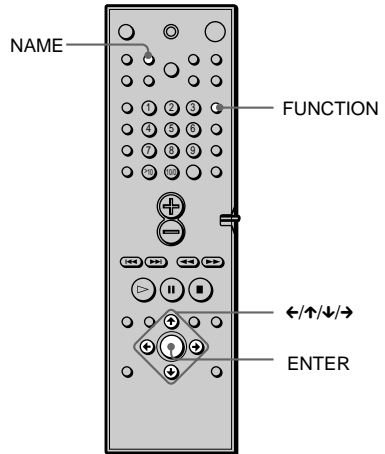

1 Press **FUNCTION** repeatedly until **TUNER** appears on the front panel display.

The last station you received is tuned in.

Each time you press **FUNCTION**, the mode of the system changes in the following sequence:

DVD → VIDEO 1 → VIDEO 2 → TUNER → DVD...

2 Tune in the preset station you want to create an index name for.

If you are not familiar with how to tune in preset stations, see “Listening to the Radio” on page 61.

3 Press NAME.

4 Create an index name by using the cursor buttons:

Press ↓/↑ to select a character, then press → to move the cursor to the next position.

If you make a mistake

Press ← or → repeatedly until the character to be changed flashes, then press ↓/↑ to select the right character.

5 Press ENTER.

To assign index names to other stations

Repeat Steps 2 to 5.

Using the Setup Display



By using the Setup Display, you can make various adjustments to items such as picture and sound. You can also set a language for the subtitles and the Setup Display, among other things. For details on each Setup Display item, see page 65-71. For an overall list of Setup Display items, see page 82.

How to use the Setup Display

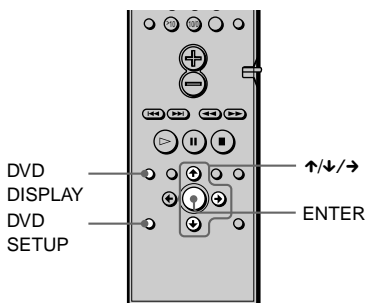

- 1** In stop mode, press DVD SETUP. The Setup Display appears.

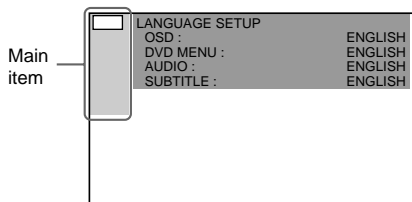

- 2** Press \uparrow/\downarrow to select the setup item from the displayed list: "LANGUAGE SETUP," "SCREEN SETUP," "CUSTOM SETUP," "SPEAKER SETUP," and "RESET". Then press ENTER or \rightarrow . The selected Setup item appears. Example: "SCREEN SETUP"

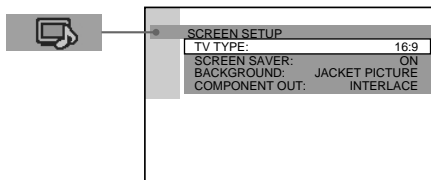

- 3** Select an item using \uparrow/\downarrow , then press ENTER or \rightarrow . The options for the selected item appear. Example: "TV TYPE"

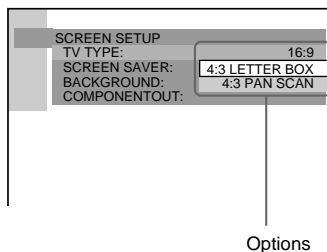

- 4 Select a setting using \uparrow/\downarrow , then press ENTER.

The setting is selected and setup is complete.

Example: "4:3 PAN SCAN"

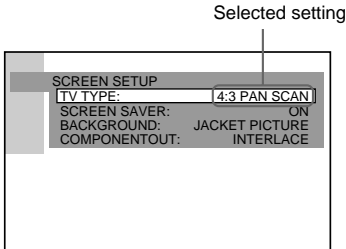

To turn off the Setup Display

Press DVD SETUP or DVD DISPLAY repeatedly until the Setup Display is turned off.

 If you select "RESET" in Step 2, you can reset all of the "SETUP" settings on page 82 (except for PARENTAL CONTROL) to the default settings. After you select "RESET" and press ENTER, select "YES" to reset the settings (it takes a few seconds to complete), or select "NO" and press ENTER to return to the Control Menu. Do not press POWER on the system or \odot when resetting the system.

Setting the Display or Sound Track Language

(LANGUAGE SETUP)



"LANGUAGE SETUP" allows you to set various languages for the on-screen display or sound track.

Select "LANGUAGE SETUP" in the Setup Display. For details on using the display, see "Using the Setup Display" (page 64).

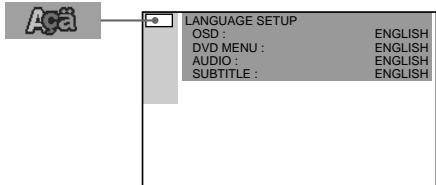

■ OSD (On-Screen Display)

Switches the display language on the screen.
Selects the language from the displayed list.

■ DVD MENU (DVD only)

Selects the desired language for the DVD menu.

■ AUDIO (DVD only)

Switches the language of the sound track.
Selects the language from the displayed list.

■ SUBTITLE (DVD only)

Switches the language of the subtitle.
Selects the language from the displayed list.

 If you select “OTHERS →” in “DVD MENU,” “SUBTITLE,” or “AUDIO,” select and enter the language code from the list using the number buttons (page 81). After you have made a selection, the language code (4 digits) is displayed the next time you select “OTHERS →.”

Note

If you select a language that is not recorded on the DVD, one of the recorded languages will be automatically selected (except for the “OSD”).

Settings for the Display

(SCREEN SETUP)



Choose settings according to the TV to be connected.

Select “SCREEN SETUP” in the Setup Display. For details on using the display, see “Using the Setup Display” (page 64). The default settings are underlined.

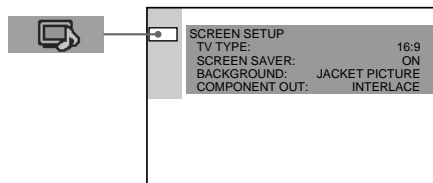

■ TV TYPE (DVD only)

Selects the aspect ratio of the connected TV (4:3 standard or wide).

The default settings vary, depending on the country model.

16:9	Select this when you connect a wide-screen TV or a TV with a wide mode function.
4:3 LETTER BOX	Select this when you connect a 4:3 screen TV. Displays a wide picture with bands on the upper and lower portions of the screen.
4:3 PAN SCAN	Select this when you connect a 4:3 screen TV. Automatically displays the wide picture on the entire screen and cuts off the portions that do not fit.

16:9



4:3 LETTER BOX



4:3 PAN SCAN



Note

Depending on the DVD, “4:3 LETTER BOX” may be selected automatically instead of “4:3 PAN SCAN” or vice versa.

SCREEN SAVER

Turns the screen saver on and off so that the screen saver image appears when you leave the system in pause or stop mode for 15 minutes, or when you playback a CD for more than 15 minutes. The screen saver will help prevent your display device from becoming damaged (ghosting). Press \blacktriangleright to turn off the screen saver.

ON	Turns on the screen saver.
OFF	Turns off the screen saver.

BACKGROUND

Selects the background color or picture on the TV screen in stop mode or while playing a CD.

JACKET PICTURE	The jacket picture (still picture) appears in the background, but only when the jacket picture is already recorded on the disc (CD-EXTRA, etc.). If the disc does not contain a jacket picture, the “GRAPHICS” picture appears.
GRAPHICS	A preset picture stored in the system appears in the background.
BLUE	The background color is blue.
BLACK	The background color is black.

COMPONENT OUT

This will change the type of signal output from the COMPONENT VIDEO OUT jacks on the system. See page 77, 78 for more information about the different types.

INTERLACE	Select this when you are connected to a standard (interlace format) TV.
PROGRESSIVE	Select this when you have a TV that can accept progressive signals.

Notes

- Unless the COMPONENT VIDEO OUT/SCAN SELECT switch on the back panel of the unit is set to “SELECTABLE,” you cannot select the above setting.
- When “PROGRESSIVE” is selected in “SCREEN SETUP,” no signal is output from the MONITOR OUT or S VIDEO OUT jacks.
- When “PROGRESSIVE” is selected in “SCREEN SETUP” and the color system of the TV is PAL, the signal is changed into the interlace format signal automatically.

Custom Settings (CUSTOM

SETUP) **DVD** **VIDEO CD** **SA-CD CD** **MP3**

Allows setting up Parental Control and other settings.

Select “CUSTOM SETUP” in the Setup Display. For details on using the display, see “Using the Setup Display” (page 64).

The default settings are underlined.

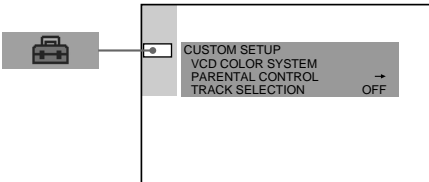

■VCD COLOR SYSTEM (Asian models and Australian models only)

Select the color system when you play a VIDEO CD.

<u>AUTO</u>	Outputs the video signal in the system of the disc, either PAL or NTSC. If your TV uses a DUAL system, select <u>AUTO</u> .
PAL	Changes the video signal of an NTSC disc and output in the PAL system.
NTSC	Changes the video signal of a PAL disc and outputs it in the NTSC system.

Notes

- You cannot change the color system of the disc itself.
- On Asian models or Australian models, you can change the color system of this unit according to the connected TV. See page 23.

■PARENTAL CONTROL → (DVD only)

Sets a password and playback limitation level for DVDs with playback limitation for children. For details, see “Limiting playback for children (Parental Control)” (page 55).

■TRACK SELECTION (DVD only)

Gives the sound track having the highest number of channels priority when you play a DVD on which multiple audio formats (PCM, MPEG audio, DTS, or Dolby Digital format) are recorded.

<u>OFF</u>	No priority given.
<u>AUTO</u>	Priority given.

Notes

- When you set the item to “AUTO,” the language may change. The “TRACK SELECTION” setting has higher priority than the “AUDIO” settings in “LANGUAGE SETUP” (page 65).
- If PCM, DTS, MPEG audio, and Dolby Digital sound tracks have the same number of channels, the system selects PCM, DTS, Dolby Digital, and MPEG audio sound tracks in this order.
- Depending on the DVD, the audio channel with priority may be predetermined. In this case, you cannot give priority to the DTS, Dolby Digital, or MPEG audio format by selecting “AUTO.”

Settings for the Speakers

(SPEAKER SETUP)

To obtain the best possible surround sound, set the size of the speakers you have connected and their distance from your listening position. Then use the test tone to adjust the volume and the balance of the speakers to the same level.

Select “SPEAKER SETUP” in the setup display. For details, see “Using the Setup Display” (page 64).

The default settings are underlined.

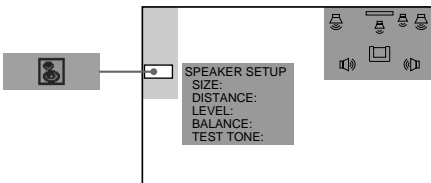

To return to the default setting

Select the item, then press CLEAR.

■ SIZE

When you do not connect center or rear speakers, or move the rear speakers, set the parameters for CENTER and REAR. Since the front speaker and subwoofer settings are fixed, you cannot change them. The default settings are underlined.

- FRONT
 - YES
- CENTER
 - YES: Normally select this.
 - NONE: Select this if no center speaker is used.
- REAR
 - BEHIND (LOW), BEHIND (HIGH), SIDE (LOW), SIDE (HIGH): Specify the position and height to implement the Digital Cinema Surround modes.
 - NONE: Select this if no rear speaker is used.
- SUBWOOFER
 - YES

Notes

- When you select an item, the sound cuts off for a moment.
- Depending on the settings of other speakers, the subwoofer may output excessive sound.

Specifying the rear speaker position and height

If you select anything other than “NONE” in “REAR,” specify the position and height of the rear speakers. The default setting is underlined.

<u>BEHIND (LOW)</u>	Select this if the rear speakers are located in section B and D .
BEHIND (HIGH)	Select this if the rear speakers are located in section B and C .
SIDE (LOW)	Select this if the rear speakers are located in section A and D .
SIDE (HIGH)	Select this if the rear speakers are located in section A and C .

These parameters are not available when “REAR” is set to “NONE.”

Position diagram

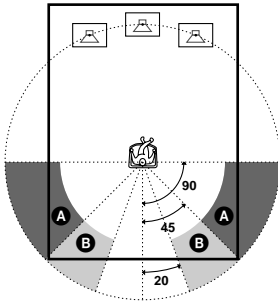

Height diagram

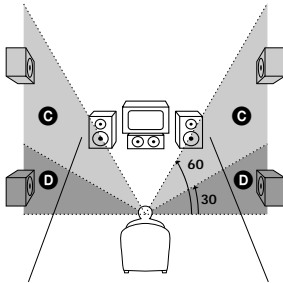

■ DISTANCE

The default distance setting for the speakers in relation to the listening position is shown below.

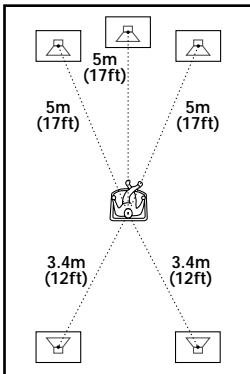

Be sure to change the value in the Setup Display when you move the speakers. The default settings are underlined.

FRONT <u>5 m/17 ft</u>	Front speaker distance from the listening position can be set in 0.2 meter (1.0 ft) increments from 1.0 to 15.0 meters (3.0 to 50.0 feet).
CENTER <u>5 m/17 ft</u>	Center speaker distance can be moved up to 1.6 meters (5.0 ft) forward closer to the listening position, in 0.2 meter (1.0 ft) increments.
REAR <u>3.4 m/12 ft</u>	Rear speaker distance can be moved up to 4.6 meters (15.0 ft) closer to your listening position from the front speaker position, in 0.2 meter (1.0 ft) increments.

Notes

- In **SPEAKER SETUP**, the North American model's OSD displays both metric and imperial measurements. The other model's displays metric measurements only. The manual shows both.
- When you set the distance, the sound cuts off for a moment.
- If each of the front or rear speakers are not placed at an equal distance from your listening position, set the distance according to the closest speaker.
- Do not place the rear speakers farther away from your listening position than the front speakers.

■ LEVEL

You can vary the level of each speaker as follows. Be sure to set "TEST TONE" to "ON" for easy adjustment.

The default settings are underlined.

CENTER <u>0 dB</u>	Adjusts the level of the center speaker (-6 dB to +6 dB, 1 dB increments).
REAR <u>0 dB</u>	Adjusts the level of the rear speakers (-6 dB to +6 dB, 1 dB increments).
SUBWOOFER <u>0 dB</u>	Adjusts the level of the subwoofer (-6 dB to +6 dB, 1 dB increments).

■ BALANCE

You can vary the balance of the left and right speakers as follows. Be sure to set “TEST TONE” to “ON” for easy adjustment. The default settings are underlined.

<u>FRONT CENTER</u>	Adjust the balance between the front left and right speakers (You can adjust from center 6 steps left or right).
<u>REAR CENTER</u>	Adjust the balance between the rear left and right speakers (You can adjust from center 6 steps left or right).

To adjust the volume of all the speakers at one time

Use the VOLUME control on the system or press VOL +/-.

■ TEST TONE

The speakers will emit a test tone to adjust “BALANCE” and “LEVEL.”

<u>OFF</u>	The test tone is not emitted from the speakers.
<u>ON</u>	The test tone is emitted from each speaker in sequence while adjusting balance or level. When you select one of the “SPEAKER SETUP” items, the test tone is emitted from both left and right speakers simultaneously.

Adjusting the speaker volume and level

- 1 After you stop playback, select “SPEAKER SETUP” after pressing DVD SETUP in the Setup Display.
- 2 Select “TEST TONE” and set “TEST TONE” to “ON.”
You will hear the test tone from each speaker in sequence.
- 3 From your listening position, select “BALANCE” or “LEVEL” and adjust the value of “BALANCE” and “LEVEL” using \uparrow/\downarrow .
The test tone is emitted from both left and right speakers simultaneously.
- 4 Select “TEST TONE” and set “TEST TONE” to “OFF” to turn off the test tone.

Note

When you adjust the speaker settings, the sound cuts off for a moment.

Troubleshooting

If you experience any of the following difficulties while using the system, use this troubleshooting guide to help remedy the problem before requesting repairs. Should any problem persist, consult your nearest Sony dealer.

Power

The power is not turned on.

- ➔ Check that the AC power cord (mains lead) is connected securely.

Picture

There is no picture.

- ➔ The video connecting cords are not connected securely.
- ➔ The video connecting cords are damaged.
- ➔ The system is not connected to the correct TV input jack (page 22).
- ➔ The video input on the TV is not set so that you can view pictures from the system.
- ➔ You have set "COMPONENT OUT" in "SCREEN SETUP" to "PROGRESSIVE" even though your TV cannot accept the signal in progressive format. In this case, set the COMPONENT VIDEO OUT/SCAN SELECT switch on the back panel of the unit to INTERLACE. Then set "COMPONENT OUT" to "INTERLACE" after you can see the TV screen correctly, and reset the COMPONENT VIDEO OUT/SCAN SELECT switch to SELECTABLE.
- ➔ Even if your TV is compatible with progressive format (480p) signals, the image may be affected when you set "COMPONENT OUT" to "PROGRESSIVE." In this case, set "COMPONENT OUT" to "INTERLACE."
- ➔ When "PROGRESSIVE" is selected in "SCREEN SETUP," no signal is output from the MONITOR OUT or S VIDEO OUT jacks.

Picture noise appears.

- ➔ The disc is dirty or flawed.
- ➔ If the picture output from your system goes through your VCR to get to your TV, the copy-protection signal applied to some DVD programs could affect picture quality. If you still experience problems even when you connect your system directly to your TV, try connecting your system to your TV's S video input (page 22).

Even though you set the aspect ratio in "TV TYPE" of "SCREEN SETUP," the picture does not fill the screen.

- ➔ The aspect ratio of the disc is fixed on your DVD.

The picture is black and white.

- ➔ Depending on the TV, the picture on the screen becomes black and white when you play a disc recorded in the NTSC color system.

Sound

There is no sound.

- ➔ The audio connecting cord is not connected securely.
- ➔ The audio connecting cord is damaged. Replace it with a new one.
- ➔ Press MUTING on the remote if "MUTING ON" is displayed on the front panel display.
- ➔ The protective device on the system has been activated because of a short circuit. Turn off the system, eliminate the short-circuit problem and turn on the power again.
- ➔ The system is in pause mode or in Slow-motion Play mode. Press ▷ to return to normal play mode.
- ➔ Fast forward or fast reverse is performed. Press ▷ to return to normal play mode.
- ➔ Check the speaker settings (pages 24, 69).

The left and right sounds are unbalanced or reversed.

- ➔ Check that the speakers and components are connected correctly and securely.
- ➔ Adjust the balance parameter in the BALANCE menu (pages 27, 71).

Severe hum or noise is heard.

- ➔ Check that the speakers and components are connected securely.
- ➔ Check that the connecting cords are away from a transformer or motor, and at least 3 meters (10 feet) away from a TV set or fluorescent light.
- ➔ Move your TV away from the audio components.
- ➔ The plugs and jacks are dirty. Wipe them with a cloth slightly moistened with alcohol.
- ➔ Clean the disc.

The sound loses stereo effect when you play a VIDEO CD, or a CD.

- ➔ Set "AUDIO" to "STEREO" in the Control Menu display (page 46).
- ➔ Make sure you connect the system appropriately.

The surround effect is difficult to hear when you are playing a Dolby Digital sound track.

- ➔ Make sure the sound field function is on (page 48).
- ➔ Check the speaker connections and settings (pages 24, 69).
- ➔ Depending on the DVD, the output signal may not be the entire 5.1 channel. It may be monaural or stereo even if the sound track is recorded in Dolby Digital or MPEG audio format.

The surround effect is difficult to hear when you are playing a Dolby Digital or MPEG audio sound track.

- ➔ Check the speaker connections and setting (pages 24, 69).

- ➔ Depending on the DVD, the output signal may not be the entire 5.1 channel. It may be monaural or stereo even if the sound track is recorded in Dolby Digital or MPEG audio format.

The sound comes from the center speaker only.

- ➔ Depending on the disc, the sound may come from the center speaker only.

No sound is heard from the center speaker.

- ➔ Check the speaker connections and settings.
- ➔ Make sure the sound field function is on (page 48).
- ➔ Select a sound field containing the word "cinema" (page 48).

No sound or only a very low-level sound is heard from the rear speakers.

- ➔ Check the speaker connections and settings.
- ➔ Make sure the sound field function is on (page 48).
- ➔ Select a sound field containing the word "cinema" (page 48).

Operation

Radio stations cannot be tuned in.

- ➔ Check that the antennas are connected securely. Adjust the antennas and connect an external antenna if necessary.
- ➔ The signal strength of the stations is too weak (when tuning in with automatic tuning). Use direct tuning.
- ➔ No stations have been preset or the preset stations have been cleared (when tuning by scanning preset stations). Preset the stations (page 29).
- ➔ Press DISPLAY so that the frequency appears in the display.

The remote does not function.

- ➔ There are obstacles between the remote and the system.
- ➔ The distance between the remote and the system is too far.
- ➔ The remote is not pointed at the remote sensor on the system.
- ➔ The batteries in the remote are weak.

The disc does not play.

- ➔ There is no disc inside.
- ➔ The disc is turned over.
Insert the disc with the playback side facing down on the disc tray.
- ➔ The disc is skewed.
- ➔ The system cannot play CD-ROMs, etc. (page 8).
- ➔ The region code on the DVD does not match the system.
- ➔ Moisture has condensed inside the system.
Remove the disc and leave the system turned on for about half an hour (page 4).

The MP3 audio track cannot be played.

- ➔ The DATA CD is not recorded in the MP3 format that conforms to ISO9660 Level 1/Level 2 or Joliet.
- ➔ The MP3 audio track does not have the extension “.MP3.”
- ➔ The data is not formatted in MP3 even though it has the extension “.MP3.”
- ➔ The system cannot play audio tracks in MP3PRO format.

The title of the MP3 audio album or track is not correctly displayed.

- ➔ The system can only display numbers and alphabet. Other characters are displayed as “ ”.

The disc does not start playing from the beginning.

- ➔ Program Play, Shuffle Play, or Repeat Play has been selected (pages 36, 38, 39).
Press CLEAR to cancel these functions before playing a disc.
- ➔ Resume Play has been selected.
During stop, press ■ on the system or the remote and then start playback (page 32).
- ➔ The title, DVD or PBC menu automatically appears on the TV screen.

The system starts playing the disc automatically.

- ➔ The DVD features an auto playback function.

Playback stops automatically.

- ➔ Some discs may contain an auto pause signal.
While playing such a disc, the system stops playback at the auto pause signal.

You cannot perform some functions such as Stop, Search, Slow-motion Play, Repeat Play, Shuffle Play, or Program Play.

- ➔ Depending on the disc, you may not be able to do some of the operations above. See the operating manual that comes with the disc.

Messages do not appear on the screen in the language you want.

- ➔ In the Setup Display, select the desired language for the on-screen display in “OSD” under “LANGUAGE SETUP” (page 65).

The language for the sound track cannot be changed.

- ➔ Multilingual tracks are not recorded on the DVD being played.
- ➔ The DVD prohibits changing the language for the sound track.

The subtitle language cannot be changed.

- ➔ Multilingual subtitles are not recorded on the DVD being played.
- ➔ The DVD prohibits changing the subtitles.

The subtitle cannot be turned off.

- ➔ The DVD prohibits turning off subtitles.

The angles cannot be changed.

- ➔ Multi-angles are not recorded on the DVD being played. The angle can be changed only when the “ANGLE” indicator lights up on the front panel display.
- ➔ The DVD prohibits changing the angles.

The system does not operate properly.

- ➔ If static electricity, etc., causes the system to operate abnormally, press POWER on the system to turn the system off and then on again.

Nothing is displayed on the front panel display.

- ➔ Press DIMMER on the remote.

A 5-character service number is displayed on the screen and on the front panel display.

- ➔ The self-diagnosis function was activated. (See the table on page 76.)

A disc cannot be ejected and “LOCKED” appears on the front panel display.

- ➔ Contact your Sony dealer or local authorized Sony service facility.

“PROTECT” appears on the front panel display.

- ➔ The speaker protection circuit is in function. Check the speaker connections.
-

Self-diagnosis Function

(When letters/numbers appear in the display)

When the self-diagnosis function is activated to prevent the system from malfunctioning. In this case a five-character service number (e.g., C 13 00) with a combination of a letter and digits appears on the screen and the front panel display. Refer to the following table.

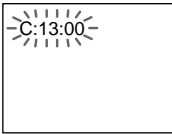

First three characters of the service number	Cause and/or Corrective Action
C 13	The disc is dirty. ➔ Clean the disc with a soft cloth (page 9).
C 31	The disc is not inserted correctly. ➔ Re-insert the disc correctly.
E XX (xx is a number)	To prevent a malfunction, the system has performed the self-diagnosis function. ➔ Contact your nearest Sony dealer or local authorized Sony service facility and give the 5-character service number. Example: E 61 10

Glossary

Album

Section of a music piece on a data CD containing MP3 audio tracks.

Chapter

Sections of a picture or a music piece on a DVD that are smaller than titles. A title is composed of several chapters.

Digital Cinema Sound (DCS)

This is the generic name of the surround sound produced by digital signal processing technology developed by Sony. Unlike previous surround sound fields mainly directed at the reproduction of music, Digital Cinema Sound is designed specifically for the enjoyment of movies.

Dolby Digital

This sound format for movie theaters is more advanced than Dolby Pro Logic Surround. In this format, the rear speakers output stereo sound with an expanded frequency range and a subwoofer channel for deep bass is independently provided. This format is also called "5.1" because the subwoofer channel is counted as 0.1 channel (since it functions only when a deep bass effect is needed). All six channels in this format are recorded separately to realize superior channel separation. Furthermore, since all the signals are processed digitally, less signal degradation occurs.

Dolby Pro Logic Surround

As one method of decoding Dolby Surround, Dolby Pro Logic Surround produces four channels from two-channel sound. Compared with the former Dolby Surround system, Dolby Pro Logic Surround reproduces left-to-right panning more naturally and localizes sounds more precisely. To take full advantage of Dolby Pro Logic Surround, you should have one pair of rear speakers and a center speaker. The rear speakers output monaural sound.

Dolby Pro Logic II

Dolby Pro Logic II creates five full-bandwidth output channels from two-channel sources. This is done using an advanced, high-purity matrix surround decoder that extracts the spatial properties of the original recording without adding any new sounds or tonal colorations.

Movie mode

The Movie mode is for use with stereo television shows and all programs encoded in Dolby Surround. The result is enhanced soundfield directionality that approaches the quality of discrete 5.1-channel sound.

Music mode

The Music mode is for use with any stereo music recordings, and provides a wide and deep sound space.

DTS

Digital audio compression technology that the Digital Theater Systems, Inc. developed. This technology conforms to 5.1-channel surround. The rear channel is stereo and there is discrete subwoofer channel in this format. DTS provides the same 5.1 discrete channels of high quality digital audio. The good channel separation is realized because the all channel data is recorded discrete and processed in digital.

DVD

A disc that contains up to 8 hours of moving pictures even though its diameter is the same as a CD.

The data capacity of a single-layer and single-sided DVD, at 4.7 GB (Giga Byte), is 7 times that of a CD. Furthermore, the data capacity of a dual-layer and single-sided DVD is 8.5 GB, a single-layer and double-sided DVD 9.4 GB, and a dual-layer and double-sided DVD 17 GB.

The picture data uses the MPEG 2 format, one of the worldwide standards of digital compression technology. The picture data is compressed to about 1/40 of its original size.

The DVD also uses the variable rate coding technology that changes the data to be allocated according to the status of the picture.

The audio data is recorded in Dolby Digital as well as in PCM, allowing you to enjoy more real audio presence.

Furthermore, various advanced functions such as the multi-angle, multilingual, and Parental Control functions are provided with the DVD.

Film based software, Video based software

DVDs can be classified as Film based or Video based software. Film based DVDs contain the same images (24 frames per second) that are shown at movie theaters. Video based DVDs, such as television dramas or sit-coms, displays images at 30 frames (or 60 fields) per second.

Interlace format

Interlace format shows every other line of an image as a single “field” and is the standard method for displaying images on television. The even number field shows the even numbered lines of an image, and the odd numbered field shows the odd numbered lines of an image.

Multi-angle function

Various angles, or viewpoints of the video camera, for a scene are recorded on some DVDs.

Multilingual function

Several languages for the sound or subtitles in a picture are recorded on some DVDs.

Parental Control

A function of the DVD to limit playback of the disc by the age of the users according to the limitation level in each country. The limitation varies from disc to disc; when it is activated, playback is completely prohibited, violent scenes are skipped or replaced with other scenes and so on.

Playback Control (PBC)

Signals encoded on VIDEO CDs (Version 2.0) to control playback.

By using menu screens recorded on VIDEO CDs with PBC functions, you can enjoy playing simple interactive programs, programmes with search functions, and so on.

Progressive format

Compared to the Interlace format that alternately shows every other line of an image (field) to create one frame, the Progressive format shows the entire image at once as a single frame. This means that while the Interlace format can show 30 frames (60 fields) in one second, the Progressive format can show 60 frames in one second. The overall picture quality increases and still images, text, and horizontal lines appear sharper. This system is compatible with the 480 progressive format.

Region Code

This system is used to protect copyrights. A region number is allocated on each DVD system or DVD disc according to the sales region. Each region code is shown on the system as well as on the disc packaging. The system can play the discs that match its region code. The system can also play discs with the “” mark. Even when the region code is not shown on the DVD, the region limit may still be activated.

Scene

On a VIDEO CD with PBC (playback control) functions, the menu screens, moving pictures and still pictures are divided into sections called “scenes.”

Super Audio CD

This audio format is based upon the current audio CD standards but includes a greater amount of information which provides higher quality sound. There are three types of discs: single layer, double layer and hybrid discs. The hybrid disc contains both standard audio CD and Super Audio CD information.

Title

The longest sections of a picture or music feature on a DVD, movie, etc., in video software, or the entire album in audio software.

Track

Sections of a picture or a music piece on a Super Audio CD, CD, VIDEO CD or MP3. An album is composed of several tracks (MP3 only).

VIDEO CD

A compact disc that contains moving pictures.

The picture data uses the MPEG 1 format, one of the worldwide standards of digital compression technology. The picture data is compressed to about 1/140 of its original size. Consequently, a 12 cm VIDEO CD can contain up to 74 minutes of moving pictures. VIDEO CDs also contain compact audio data. Sounds outside the range of human hearing are compressed while the sounds we can hear are not compressed. VIDEO CDs can hold 6 times the audio information of conventional audio CDs.

There are 2 versions of VIDEO CDs.

- Version 1.1: You can play only moving pictures and sounds.
- Version 2.0: You can play high-resolution still pictures and enjoy PBC functions.

This system conforms to both versions.

Specifications

Amplifier section

Stereo mode	80 W + 80 W (4 ohms at 1 kHz, THD 10 %)
Surround mode	Front: 80 W + 80 W Center*: 80 W Rear*: 80 W + 80 W (4 ohms at 1 kHz, THD 10 %) Subwoofer*: 100 W (3 ohms at 100 Hz, THD 10 %)

* Depending on the sound field settings and the source, there may be no sound output.

Inputs (Analog)	VIDEO 1, 2: Sensitivity: 150 mV Impedance: 50 kilohms
Inputs (Digital)	VIDEO 2 (optical): Sensitivity: –
Outputs (Analog)	VIDEO 1 (AUDIO OUT): Voltage: 2 V Impedance: 1 kilohms PHONES: Accepts low- and high-impedance headphones

Super Audio CD/DVD system

Laser	Semiconductor laser (Super Audio CD/DVD: $\lambda = 650$ nm) (CD: $\lambda = 780$ nm) Emission duration: continuous
Signal format system	NTSC or NTSC/PAL
Frequency response (at 2 CH STEREO mode)	DVD (PCM): 2 Hz to 22 kHz (± 1.0 dB) CD: 2 Hz to 20 kHz (± 1.0 dB)
Signal-to-noise ratio	More than 80 dB (VIDEO 1 (AUDIO) connectors only)
Harmonic distortion	Less than 0.03 %

FM tuner section

System	PLL quartz-locked digital synthesizer system
Tuning range	87.5 – 108.0 MHz (50 kHz step)
Antenna	FM wire antenna
Antenna terminals	75 ohms, unbalanced
Intermediate frequency	10.7 MHz

AM tuner section

System	PLL quartz-locked digital synthesizer system
Tuning range	
European, Middle Eastern, and Philippine models:	531 – 1,602 kHz (with the interval set at 9 kHz)
Other models:	531 – 1,602 kHz (with the interval set at 9 kHz) 530 – 1,710 kHz (with the interval set at 10 kHz)
Antenna	Loop antenna
Intermediate frequency	450 KHz

Video section

Inputs	Video: 1 Vp-p 75 ohms
Outputs	Video: 1 Vp-p 75 ohms
	S video:
	Y: 1 Vp-p 75 ohms
	C: 0.286 Vp-p 75 ohms
	COMPONENT:
	Y: 1 Vp-p 75 ohms
	Pb/Cb, Pr/Cr: 0.7 Vp-p 75 ohms

Speakers

Front/Center/Rear

Speaker system	Bass reflex
Speaker unit	77 mm (3 1/8 inches) dia. cone type, 15 mm (5/8 inches) dia. balance dome
Rated impedance	4 ohms
Dimensions (approx.)	97 × 97 × 112 mm (3 7/8 × 3 7/8 × 4 1/2 inches) (w/h/d)
Mass (approx.)	0.795 kg (1 lb 13 oz)

Subwoofer

Speaker system	Closed type
Speaker unit	160 mm (6 3/8 inches) dia. cone type
Rated impedance	3 ohms
Dimensions (approx.)	217 × 302 × 217 mm (8 5/8 × 12 × 8 5/8 inches) (w/h/d)
Mass (approx.)	4.6 kg (10 lb 3 oz)

General

Power requirements	
European model:	230 V AC, 50/60 Hz
Australian and Asian models:	220 – 240 V AC, 50/60 Hz
Mexican model:	120 V AC, 60 Hz
Chinese model:	220 V AC, 50/60 Hz
Taiwan model:	110 – 120 V AC, 50/60 Hz
Other models:	110 – 240 V/220 – 240 V AC, 50/60 Hz
Power consumption	120 W (120 V AC) 120 W (230 V AC) 1 W (120 V AC) 2 W (230 V AC) (at the Power Saving Mode)
Dimensions (approx.)	355 × 60 × 323 mm (14 × 2 3/8 × 12 3/4 inches) (w/h/d) incl. projecting parts
Mass (approx.)	3.8 kg (8 lb 7 oz)
Operating temperature	5°C to 35°C (41°F to 95°F)
Operating humidity	5 % to 90 %
Supplied accessories	See page 16.

Design and specifications are subject to change without notice.

Language Code List

For details, see pages 46, 53, 66.

The language spellings conform to the ISO 639: 1988 (E/F) standard.

Code Language	Code Language	Code Language	Code Language
1027 Afar	1183 Irish	1347 Maori	1507 Samoan
1028 Abkhazian	1186 Scots Gaelic	1349 Macedonian	1508 Shona
1032 Afrikaans	1194 Galician	1350 Malayalam	1509 Somali
1039 Amharic	1196 Guarani	1352 Mongolian	1511 Albanian
1044 Arabic	1203 Gujarati	1353 Moldavian	1512 Serbian
1045 Assamese	1209 Hausa	1356 Marathi	1513 Siswati
1051 Aymara	1217 Hindi	1357 Malay	1514 Sesotho
1052 Azerbaijani	1226 Croatian	1358 Maltese	1515 Sundanese
1053 Bashkir	1229 Hungarian	1363 Burmese	1516 Swedish
1057 Byelorussian	1233 Armenian	1365 Nauru	1517 Swahili
1059 Bulgarian	1235 Interlingua	1369 Nepali	1521 Tamil
1060 Bihari	1239 Interlingue	1376 Dutch	1525 Telugu
1061 Bislama	1245 Inupiak	1379 Norwegian	1527 Tajik
1066 Bengali; Bangla	1248 Indonesian	1393 Occitan	1528 Thai
1067 Tibetan	1253 Icelandic	1403 (Afan)Oromo	1529 Tigrinya
1070 Breton	1254 Italian	1408 Oriya	1531 Turkmen
1079 Catalan	1257 Hebrew	1417 Punjabi	1532 Tagalog
1093 Corsican	1261 Japanese	1428 Polish	1534 Setswana
1097 Czech	1269 Yiddish	1435 Pashto; Pushto	1535 Tonga
1103 Welsh	1283 Javanese	1436 Portuguese	1538 Turkish
1105 Danish	1287 Georgian	1463 Quechua	1539 Tsonga
1109 German	1297 Kazakh	1481 Rhaeto- Romance	1540 Tatar
1130 Bhutani	1298 Greenlandic	1482 Kirundi	1543 Twi
1142 Greek	1299 Cambodian	1483 Romanian	1557 Ukrainian
1144 English	1300 Kannada	1489 Russian	1564 Urdu
1145 Esperanto	1301 Korean	1491 Kinyarwanda	1572 Uzbek
1149 Spanish	1305 Kashmiri	1495 Sanskrit	1581 Vietnamese
1150 Estonian	1307 Kurdish	1498 Sindhi	1587 Volapük
1151 Basque	1311 Kirghiz	1501 Sangho	1613 Wolof
1157 Persian	1313 Latin	1502 Serbo-Croatian	1632 Xhosa
1165 Finnish	1326 Lingala	1503 Singhalese	1665 Yoruba
1166 Fiji	1327 Laothian	1505 Slovak	1684 Chinese
1171 Faroese	1332 Lithuanian	1506 Slovenian	1697 Zulu
1174 French	1334 Latvian; Lettish		
1181 Frisian	1345 Malagasy		
			1703 Not specified

DVD Setup Menu List

You can set the following items with the DVD setup menu.
The order of the displayed items may be different from the actual display.

LANGUAGE SETUP

- OSD — (Select the language you want to use from the displayed language list.)
- DVD MENU — (Select the language you want to use from the displayed language list.)
- AUDIO — (Select the language you want to use from the displayed language list.)
- SUBTITLE — (Select the language you want to use from the displayed language list.)

CUSTOM SETUP

- VCD COLOR SYSTEM* —
 - AUTO
 - PAL
 - NTSC
- PARENTAL CONTROL —
 - LEVEL —
 - OFF
 - 8.
 - 7. NC17
 - 6. R
 - 5.
 - 4. PG13
 - 3. PG
 - 2.
 - 1. G
 - STANDARD —
 - USA
 - OTHERS →
 - CHANGE PASSWORD
- TRACK SELECTION —
 - OFF
 - AUTO

SCREEN SETUP

- TV TYPE —
 - 16:9
 - 4:3 LETTER BOX
 - 4:3 PAN SCAN
- SCREEN SAVER —
 - ON
 - OFF
- BACKGROUND —
 - JACKET
 - PICTURE
 - GRAPHICS
 - BLUE
 - BLACK
- COMPONENT OUT —
 - INTERLACE
 - PROGRESSIVE

SPEAKER SETUP

- SIZE —
 - FRONT — YES
 - CENTER —
 - YES
 - NONE
 - REAR —
 - BEHIND —
 - LOW
 - HIGH
 - SIDE —
 - LOW
 - HIGH
 - NONE
 - SUBWOOFER — YES
- DISTANCE** —
 - FRONT — 1.0m ~ 15m/
3ft ~ 50ft
 - CENTER — 0m ~ 15m/
0ft ~ 50ft
 - REAR — 0m ~ 15m/
0ft ~ 50ft
- LEVEL —
 - CENTER — -6 dB ~ +6 dB
 - REAR — -6 dB ~ +6 dB
 - SUBWOOFER — -6 dB ~ +6 dB
- BALANCE —
 - FRONT — 6 steps left or right
 - REAR — 6 steps left or right
- TEST TONE —
 - OFF
 - ON

RESET

— YES

- * Only for Asian models and Australian models.
- ** In SPEAKER SETUP, the North American model's OSD displays both metric and imperial measurements. The other model's displays metric measurements only. The manual shows both.

Index

Numerics

16:9 66
4:3 LETTER BOX 66
4:3 PAN SCAN 66

A

Album 7, 76
ALBUM 35, 41
AMP MENU 25
ANGLE 52
Antenna Hookups 20
AUDIO 46, 65

B

BACKGROUND 67
BALANCE 27, 71
BAND 29
Batteries 17

C

CHAPTER 42
Chapter 7, 76
COMPONENT OUT 67
Continuous play
 CD/VIDEO/Super Audio CD/
 DVD/MP3 31
Control Menu 14
CUSTOM PARENTAL
 CONTROL 54
CUSTOM SETUP 68

D

DIMMER 28
DISTANCE 26, 70
Dolby Digital 76
Dolby Pro Logic Surround 76
DTS 77
DVD 33, 77
DVD MENU 33, 65

F

Fast forward 40
Fast reverse 40
Front Panel 10
Front panel display 11

H

Handling discs 9

I

INDEX 42
Index 7

L

LANGUAGE SETUP 65
LEVEL 28, 70
Locating
 a specific point by watching
 the TV screen 40

M

MEMORY 29
MP3 35
Multi-angle function 52
Multilingual function 46
MUTING 32

N

NAME 62

O

On-screen display
 Control Menu display 14
 Setup Display 64
OSD 65

P

PARENTAL CONTROL
 55, 68, 78
PBC Playback 34, 78
PLAY MODE 36, 38
Preset Station 29, 61
Program Play 36

Q

Quick Overview 16

R

Radio 61
RDS 62
Rear Panel 12
Region code 8, 78
Remote 13, 59
REPEAT 39
RESET 65
Resume Play 32

S

S VIDEO 22
Scan 40
SCENE 14
Scene 7, 78
SCREEN SAVER 67
SCREEN SETUP 66
SHUFFLE 38
Shuffle Play 38
SIZE 25, 69
Slow-motion Play 40
Sound Field 48
SPEAKER SETUP 69
Speaker System Hookup 17
SUBTITLE 53, 65
Super Audio CD 78

T

TEST TONE 71
TIME 42, 43
TIME SEARCH 41
TITLE 41
Title 7, 78
TRACK 41
Track 7, 78
TRACK SELECTION 68
Troubleshooting 72
TV and Video Component
 Hookups 22
TV TYPE 66

U

Usable discs 7

V

VCD COLOR SYSTEM 68
VIDEO CD 34, 78

Quick reference for Remote Commander

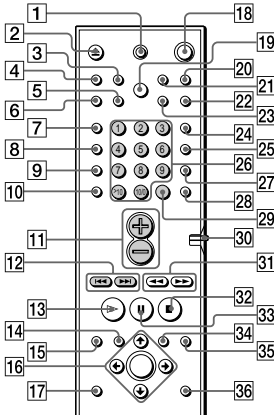

☞ Shaded parts buttons are affected by the COMMAND MODE DVD/TV switch. Shaded descriptions refer to TV setting on the switch.

Note

The remote control of the unit employs command signals in common with other Sony DVD products. Thus, depending on the button, other Sony DVD products may respond.

- | | |
|--|--|
| <p>1 TV I/⏻ (on/standby)
Turns the TV on and off.</p> <p>2 ▲ EJECT
Ejects the disc.</p> <p>3 NAME
Activates the name function.</p> <p>4 STEREO/MONO
Switches monaural or stereo of FM stereo reception.</p> <p>5 MEMORY
Press to store a preset station.</p> <p>6 CLEAR
Press to return to the Continuous play, etc.</p> <p>7 PLAY MODE
Selects program or shuffle play mode.</p> <p>8 AUDIO
Changes the sound while playing a DVD or VIDEO CD.</p> <p>9 ANGLE
Changes the angles when playing a DVD.</p> <p>10 SUBTITLE
Displays the "SUBTITLE" menu in the Control Menu display.</p> <p>11 VOL +/-
Adjust the SYSTEM volume. TV : Adjust the TV volume.</p> <p>12 ⏮/⏭, PREV/NEXT, TV CH -/+ , PRESET -/+
⏮/⏭ PREV/NEXT : Press to go to the next chapter or track or to go back to the previous chapter or track.
PRESET -/+ : Scan all preset stations.
TV CH -/+ : Select the TV Channel</p> | <p>13 ▷ PLAY/SELECT
Plays a disc.</p> <p>14 DVD TOP MENU
Displays the title menu on the TV screen.</p> <p>15 DVD DISPLAY
Displays the Control Menu display on the TV screen to set or adjust the items.</p> <p>16 ⏪/⏩/⏴/ENTER
Selects and executes the items or settings.</p> <p>17 DVD SETUP
Displays the setup display on the TV screen to set or adjust the items.</p> <p>18 ⏻ (standby)
Turns on and off the power of the system.</p> <p>19 DIMMER
Changes the brightness of the front panel display by two steps.</p> <p>20 TV/VIDEO
Changes the input mode of the TV.</p> <p>21 REPEAT
Displays the "REPEAT" display on the TV screen.</p> <p>22 MUTING
Mutes the sound.</p> <p>23 TIME
Displays the playing time of the disc, etc., on the front panel display.</p> <p>24 FUNCTION
Selects the component you want to use.</p> <p>25 BAND
Selects AM or FM band.</p> <p>26 Number buttons*
Selects the items of settings.
TV : Selects channel numbers.</p> <p>27 SOUND FIELD
Selects the sound field.</p> <p>28 DISPLAY
Switches the item displayed on the front panel display.</p> <p>29 ENTER
Executes the items or settings. TV : Press after selecting a channel number</p> <p>30 COMMAND MODE DVD TV switch
Switches the TV's input source between the TV and DVD.</p> <p>31 ⏮/⏭, ⏪/⏩, ⏴/⏵ SLOW, TUNING -/+
⏮/⏭ (SCAN) : Locate a point while monitoring the picture while playing disc.
⏪/⏩ SLOW : Play a disc in slow motion in the pause mode.
TUNING -/+ : Scan all available radio stations.</p> <p>32 ■ STOP
Stops playing a disc.</p> <p>33 II PAUSE
Pauses playing a disc.</p> <p>34 DVD MENU
Displays the DVD menu on the TV screen.</p> <p>35 ⏪ RETURN
Press to return to the previously selected screen, etc.</p> <p>36 AMP MENU
Displays the speaker set up parameters on the front panel display.</p> |
|--|--|

* Depending on the TV set, you can also enter the number as follows:
Press >10, then the number. (For example, press >10, then 2 and 5 for entering 25.)