

Mini Hi-Fi Component System

Operating Instructions



MHC-RV20

WARNING

To prevent fire or shock hazard, do not expose the unit to rain or moisture.

To prevent fire, do not cover the ventilation of the apparatus with news papers, table-cloths, curtains, etc. And don't place lighted candles on the apparatus.

To prevent fire or shock hazard, do not place objects filled with liquids, such as vases, on the apparatus.

Do not install the appliance in a confined space, such as a bookcase or built-in cabinet.

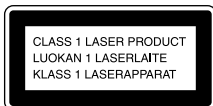

This appliance is classified as a CLASS 1 LASER product. This label is located on the rear exterior.

The following caution label is located inside the apparatus.



Don't throw away the battery with general house waste, dispose of it correctly as chemical waste.



ENERGY STAR® is a U.S. registered mark. As an ENERGY STAR® partner, Sony Corporation has determined that this product meets the ENERGY STAR® guidelines for energy efficiency.

Table of Contents

How to use this manual.....	4
Playable discs.....	4
<hr/>	
Getting Started	
Hooking up the system.....	6
Setting the clock.....	8
<hr/>	
VIDEO CD/CD/MP3 – Play	
Loading a disc.....	9
Playing a disc.....	9
— Normal Play/Shuffle Play	
Playing VIDEO CDs with PBC functions (Ver. 2.0).....	12
— PBC Play	
Playing repeatedly.....	13
— Repeat Play	
Creating your own program.....	13
— Program Play	
Locating a specific part of a VIDEO CD.....	14
— Time Search/Disc Digest	
<hr/>	
Tuner	
Presetting radio stations.....	16
Listening to the radio.....	18
— Preset Tuning	
— Manual Tuning	
<hr/>	
Tape – Play	
Loading a tape.....	19
Playing a tape.....	19
<hr/>	
Tape – Recording	
Recording your favorite CD tracks on a tape.....	20
— CD Synchro Recording	
Recording on a tape manually.....	20
— Manual Recording	

Sound Adjustment

Adjusting the sound.....	21
Selecting the sound effect.....	21
Selecting the surround effect.....	22
Enhancing video game sound.....	22
— Game Sync	
Mixing video game sound with other sound source.....	22
— Game Mixing	
Singing along.....	23

Timer

Falling asleep to music.....	24
— Sleep Timer	
Waking up to music.....	24
— Daily Timer	
Timer recording radio programs.....	25

Display

Turning off the display.....	26
— Power Saving Mode	
Viewing information about the disc in the display.....	27
Viewing information about the disc in the on-screen display.....	28

Optional Components

Hooking up optional components.....	29
-------------------------------------	----

Troubleshooting



Problems and remedies.....	30
Messages.....	33

Additional Information

Precautions.....	34
Specifications.....	35
Glossary.....	37
List of button locations and reference pages.....	38

How to use this manual

- This manual mainly explains operations using the remote, but the same operations can also be performed using the buttons on the unit having the same or similar names.
- The following symbols are used in this manual.

Symbol	Meaning
	Functions that can be used with VIDEO CDs
	Functions that can be used with audio CDs
	Functions that can be used with MP3









Discs that this system cannot play

- CD-ROMs
 - CD-Rs/CD-RWs other than those recorded in the following formats:
 - VIDEO CD format
 - Music CD format
 - MP3 format that conforms to ISO9660 Level 1/Level 2 or Joliet*
 - A disc that has a non-standard shape (e.g., card, heart).
 - A disc with paper or stickers on it.
 - A disc that has the adhesive, cellophane tape, or a sticker still left on it.
- * Up to 30 characters can be displayed.

Playable discs

You can play back the following discs on this system. Other discs cannot be played back.

List of playable discs

Format of discs	Disc logo	Contents
VIDEO CDs		Audio + Video
Audio CDs		Audio
CD-R/CD-RW (audio data)	 	Audio
CD-R/CD-RW (MP3 files)	   	Audio

Notes on CD-R and CD-RW

- Some CD-Rs or CD-RWs cannot be played on this system depending upon the recording quality or physical condition of the disc, or the characteristics of the recording device. Furthermore, the disc will not play if it has not been correctly finalized. For more information, see the operating instructions for the recording device.
- CD-R and CD-RW discs recorded in packet write format are not supported.
- Discs recorded on CD-R/CD-RW drives may not be played back because of scratches, dirt, recording condition or the driver's characteristics.
- CD-R and CD-RW discs recorded in multi-session mode are not supported.
- The system may be unable to play MP3 format files that do not have the extender ".MP3".
- Attempting to play non-MP3 format files that have the extender ".MP3" may result in noise or malfunction.
- With formats other than ISO 9660 level 1 and 2, folder names or file names may not be displayed correctly.
- The following discs take a longer time to start playback.
 - a disc recorded with complicated tree structure.
 - a disc to which data can be added (non-finalized disc).

Note on playback operations of VIDEO CDs

Some playback operations of VIDEO CDs may be intentionally set by software producers. Since this system plays VIDEO CDs according to the disc contents the software producers designed, some playback features may not be available. Also, refer to the instructions supplied with the VIDEO CDs.

Music discs encoded with copyright protection technologies

This product is designed to playback discs that conform to the Compact Disc (CD) standard. Recently, various music discs encoded with copyright protection technologies are marketed by some record companies. Please be aware that among those discs, there are some that do not conform to the CD standard and may not be playable by this product.

Getting Started

Hooking up the system

Perform the following procedures **1** to **6** to hook up your system using the supplied cords and accessories.

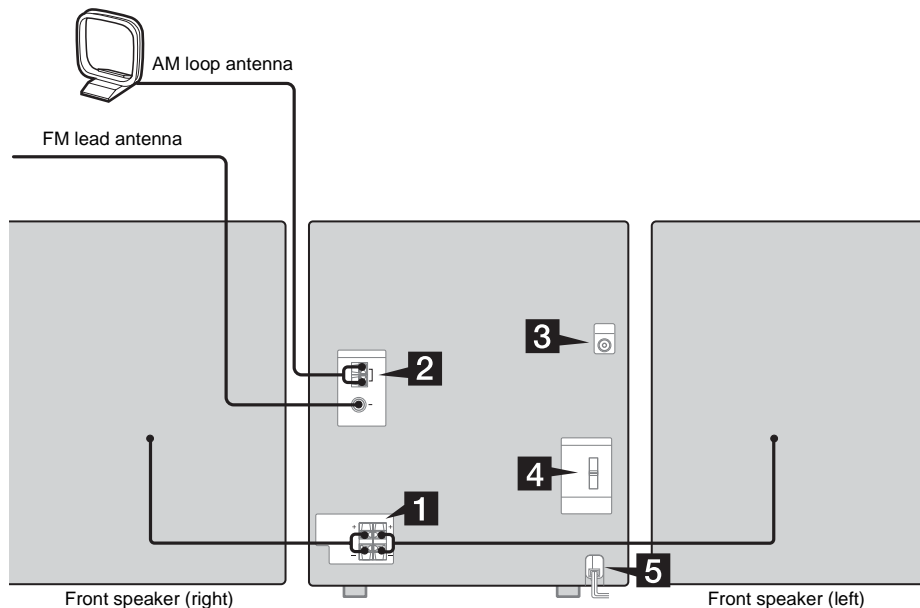

1 Connect the speakers.

Connect the right and left speaker cords to the SPEAKER terminals as shown below.

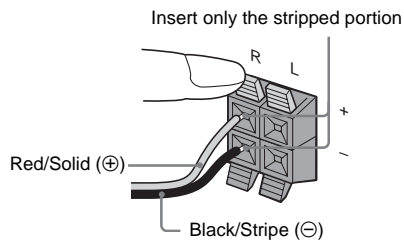

2 Connect the FM and AM antennas.

Set up the AM loop antenna, then connect it.

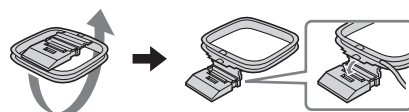

AM loop antenna

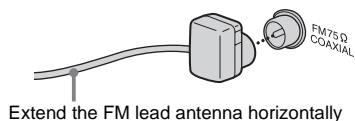

Extend the FM lead antenna horizontally

Note

Keep the antennas away from the speaker cords.

- 3** Connect the video input jack of your TV to the VIDEO OUT jack with the supplied video cord.

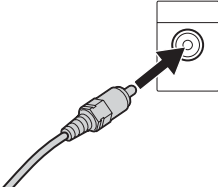

When using a TV

Turn on the TV and select the video input so you can view the pictures from this system.

- 4** For models with a voltage selector, set VOLTAGE SELECTOR to the local power line voltage.

Refer to the print on your system's VOLTAGE SELECTOR for available settings.

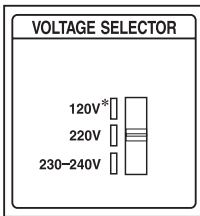

* Saudi Arabian model: 120 – 127 V

- 5** Connect the power cord to a wall outlet.

The demonstration appears in the display. When you press I/⏻, the system turns on and the demonstration automatically ends. If the plug does not fit the wall socket, detach the supplied plug adaptor (only for models equipped with an adaptor).

- 6** Set the color system to PAL or NTSC depending on the color system of your TV while the power is off.

The color system of your TV	Do this
AUTO (factory setting)	Press I/⏻ while holding down ■. If your TV automatically changes the color system according to the input signal, the system is set to AUTO.
NTSC	Press I/⏻ while holding down ►►. The system is set to NTSC.
PAL	Press I/⏻ while holding down ◀◀. The system is set to PAL.

Notes

- You cannot set the color system in Power Saving Mode.
- When you play back a VIDEO CD recorded in a different color system from the one you set to the unit, the picture image may be distorted.

Inserting two R6 (size AA) batteries into the remote

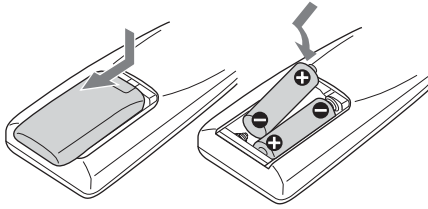

Note

If you do not use the remote for a long period of time, remove the batteries to avoid possible damage from battery leakage and corrosion.

Tip

With normal use, the batteries should last for about six months. When the remote no longer operates the system, replace both batteries with new ones.

Attaching the speaker pads

Attach the supplied front speaker pads to the bottom of the speakers to stabilize the speakers and prevent them from slipping.

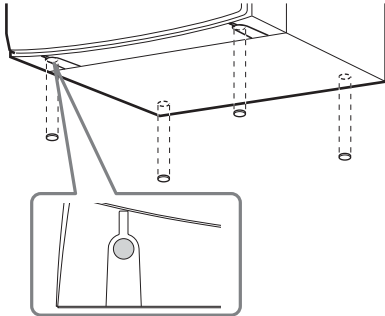

When carrying this system

Perform the following procedure to protect the CD mechanism.

- 1 Make sure that all discs are removed from the system.
- 2 Hold down CD and then press I/⏻ until "STANDBY" appears.
After "STANDBY" disappears, then "LOCK" appears.
- 3 Unplug the power cord.

Setting the clock

- 1 Press I/⏻ to turn on the system.
- 2 Press CLOCK/TIMER SET.
- 3 Press ↑ or ↓ repeatedly to set the hour.
- 4 Press →.
- 5 Press ↑ or ↓ repeatedly to set the minute.
- 6 Press ENTER.

The clock starts working.

To adjust the clock

- 1 Press CLOCK/TIMER SET.
- 2 Press ↑ or ↓ to select "CLOCK SET", then press ENTER.
- 3 Do the same procedures as step 3 to 6 above.

Notes

- The clock settings are canceled when you disconnect the power cord or if a power failure occurs.
- You cannot set the clock in Power Saving Mode.

Loading a disc

- 1 Press **▲** on the unit.
- 2 Place a disc with the label side up on the disc tray.

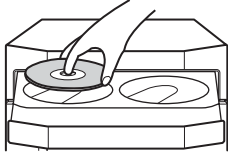

To insert additional discs, press DISC SKIP/EX-CHANGE on the unit to rotate the disc tray.

- 3 Press **▲** on the unit again to close the disc tray.

Notes

- Do not use a disc with tape, seals or paste on it as this may cause malfunction.
- Do not forcibly press the disc tray closed with your finger, as this may cause malfunction.

Playing a disc

— Normal Play/Shuffle Play



This system lets you play VIDEO CDs*, audio CDs and discs with MP3 audio tracks.

Before playing a VIDEO CD, turn on your TV and select the video input. Refer to the operating instructions supplied with your TV if you need help.

* You can play both VIDEO CDs without PBC functions (Ver. 1.1) and VIDEO CDs with PBC functions (Ver. 2.0).

Example: When a disc is loaded

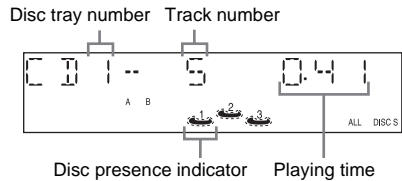

- 1 Press **CD**.

2 Press **PLAY MODE** in stop mode repeatedly until the mode you want appears in the display.

Select	To play
ALL DISCS* (Normal Play)	All discs in the disc tray continuously.
IDISC (Normal Play)	The tracks on the disc you have selected in original order.
ALBM (Normal Play)	All MP3 audio tracks in the album on the disc you have selected in original order. When playing a non-MP3 disc, Album Play performs the same operation as 1 DISC Play.
ALL DISCS SHUF (Shuffle Play)	The tracks on all discs in random order.
IDISC SHUF (Shuffle Play)	The tracks on the disc you have selected in random order.
ALBM SHUF (Shuffle Play)	The MP3 audio tracks in the album on the disc you have selected in random order. When playing a non-MP3 disc, Album Shuffle Play performs the same operation as 1 DISC SHUF Play.
PGM (Program Play)	The tracks on all discs in the order you want them to be played (see “Creating your own program” on page 13).

* Depending on VIDEO CDs with PBC functions (Ver. 2.0), the disc does not change.

3 Press **▶**.

Other operations

To	Do this
Stop play	Press ■ .
Pause	Press ⏸ *1. Press again to resume play.
Select a track or scene*2	Press ◀◀ or ▶▶ repeatedly during play or pause.
Select an album of MP3	Press ALBUM - or + repeatedly after step 2.
Find a point in a track or scene*3 (Lock Search Function)	Press ◀◀ or ▶▶ during playback. At the desired point, press ▶ to stop searching and start playback. For VIDEO CDs only, each time you press the button, speed changes cyclically as follows: 1 (slower than 2) → 2 (normal) → 3 (faster than 2)
Select a disc in stop mode	Press D . SKIP (or DISC 1 - 3 or DISC SKIP/EX-CHANGE on the unit).
Switch to CD function from another source	Press DISC 1 - 3 on the unit (Automatic Source Selection).
Exchange other discs while playing	Press DISC SKIP/EX-CHANGE on the unit.
Remove a disc	Press ▲ on the unit.

*1 For VIDEO CDs, there may be some disturbance in the video image.

*2 Only when setting the PBC function to off or when playing VIDEO CDs without PBC functions (Ver. 1.1).

*3 For discs with MP3 audio tracks, you cannot search between multiple tracks.
Also, the time may not be displayed correctly for some tracks.

Notes

- You cannot change the play mode during playback.
- Some time may be needed to start playback of discs recorded in complex configurations such as many layers.
- When the disc is inserted, the player reads all the tracks on that disc. If there are many albums or non-MP3 audio tracks on the disc, it may take a long time for play to begin or for the next MP3 audio track to start play.
- Do not save unnecessary albums or tracks other than MP3 ones in the disc to be used for MP3 listening. We recommend that you do not save other types of tracks or unnecessary albums on a disc that has MP3 audio tracks.
- An album that does not include an MP3 audio track is skipped.
- Maximum album number: 256 (including root album)
- Up to 512 tracks and albums of MP3 on a single disc can be recognized on this unit.
- MP3 audio tracks are played back in the order that they are recorded on the disc.
- Depending on the encoding/writing software, recording device, or the recording media used at the time an MP3 audio track is recorded, you may encounter such problems as disabled playback, sound interruptions, and noise.

Tip

When disc access takes a long time, set “CD POWER ON” by CD power manage function (page 17).

To play a track by entering the track number

You can also select the track you want using the remote during Normal Play.

Press the number button(s).

To enter a track number over 10

- 1 Press >10.
- 2 Enter the corresponding digits for the same number of “-” flashing in the display.
To enter 0, press 10/0.

Example:

To enter track number 30, press >10, then press 3 and 10/0.

Resuming playback from the point you stopped the disc

— Resume Play

This system memorizes the point where you stopped the VIDEO CD so you can resume from that point.

Resume Play is not available for an audio CD and a disc with MP3 audio tracks.

1 While playing a VIDEO CD, press ■ to stop playback.

“RESUME” appears on your TV screen. If “RESUME” does not appear, Resume Play is not available.

2 Press ►.

The player starts playback from the point you stopped the VIDEO CD in step 1.

Notes

- You cannot perform Resume Play during Disc Digest, Shuffle Play or Program Play.
- Depending on where you stopped the VIDEO CD, the system may resume playback from a different point.
- Resume play is canceled when:
 - you press the number buttons, PLAY MODE, ■, D. SKIP (DISC SKIP/EX-CHANGE on the unit), ◀◀/▶▶ or NEXT/PREV.
 - you disconnect the power cord.
 - you turn off the system.
 - you open the disc tray.
 - you change the function to the TUNER when “CD POWER OFF” is selected (page 17).

Tip

To view from the beginning of the VIDEO CD, press ■ in stop mode, then press ►.

Playing VIDEO CDs with PBC functions (Ver. 2.0)

— PBC Play



You can use PBC* menus on your TV screen to enjoy the disc's interactive software. The menu format and structure may differ depending on each disc.

* PBC: Playback Control

- 1 Press CD.**
- 2 Press ► to start playing a VIDEO CD with PBC functions (Ver. 2.0).**
The PBC menu appears on the TV screen.
- 3 Press the number button(s) to enter the item number you want.**
- 4 Continue playback according to the instructions on the menus to enjoy interactive playback.**

Refer to the operating instructions supplied with the disc, as the operating procedure may differ according to the VIDEO CD.

Other operations

To	Do this
Stop play	Press ■.
Go to the next menu page or scene	Press NEXT.
Go back to the previous menu page or scene	Press PREV.
Go back to the previous menu	Press RETURN ↵.
Select a menu	See "To play a track by entering the track number" (page 11).

To cancel playback with PBC functions (Ver. 2.0)

- 1 In stop mode, press ◀◀ or ▶▶ to select a track.
- 2 Press ►.

The "PBC OFF" indicator lights up and playback starts from the selected track. Still images, such as the menu screens, will not be shown.

To return to PBC playback, press ■ in stop mode, then press ►.

Tips

- When "⏏" appears on the TV screen, you have pressed an invalid button.
- When you press NEXT during menu playback or while playing moving pictures, the next scene on the disc appears. Also refer to the instructions supplied with the disc.
- You can cancel playback with PBC functions (Ver. 2.0) by pressing any number button in stop mode. The disc is automatically played in Normal Play mode.

Playing repeatedly

— Repeat Play



You can play all the tracks or a single track on a disc repeatedly.

Press REPEAT during playback until “REP” or “REP1” appears.

REP: For all the tracks on the disc, or all the tracks in the album up to five times.

REP1: For a single track only.

To cancel Repeat Play

Press REPEAT repeatedly until both “REP” and “REP1” disappear.

Notes

- You cannot select “REP” and “ALL DISCS SHUF” at the same time.
- When you select “REP1”, that track is repeated endlessly until “REP1” is canceled.
- You cannot select “REP1” during playback of VIDEO CDs with PBC functions (Ver. 2.0).

Creating your own program

— Program Play



You can make a program of up to 25 steps from all the discs in the order you want to play them. You can synchro record the programmed tracks onto a cassette tape (page 20).

- 1 Press **CD**.
- 2 Press **PLAY MODE** in stop mode repeatedly until “**PGM**” appears.
- 3 Press **D. SKIP** (or **DISC 1 – 3** or **DISC SKIP/EX-CHANGE** on the unit) to select a disc.
- 4 Press **◀◀** or **▶▶** repeatedly until the desired track number appears.

When programming an MP3, press **ALBUM –** or **+** to select album, then press **◀◀** or **▶▶** repeatedly until the desired track number appears.

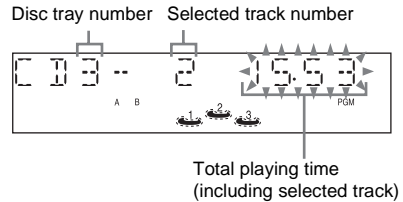

- 5 Press **ENTER**.

The track is programmed.

The program step number appears, followed by the total playing time.

6 Program additional discs or tracks.

To program	Repeat steps
Other tracks on the same disc	4 and 5
Other tracks on other discs	3 to 5

7 Press ►.

Program Play starts.

Other operations

To	Do this
Cancel Program Play	Press PLAY MODE in stop mode repeatedly until "PGM" disappears.
Clear a track from the end	Press CLEAR in stop mode.

Tips

- The program you made remains after Program Play finishes. To play the same program again, press CD, then press ►. However, the program is cleared when you open the disc tray.
- "— — —" appears when the total VIDEO CD/CD program time exceeds 100 minutes, or when you select a VIDEO CD/CD track whose number is 21 or over, or when you select an MP3 audio track.

Locating a specific part of a VIDEO CD

— Time Search/Disc Digest



The TV screen must be ON to use these functions.

Locating by elapsed time from the beginning of the disc

— Time Search

- 1 Press **SPECIAL MENU** in stop mode.
- 2 Press **1** to select "**1) TIME SEARCH**".
- 3 Press the number buttons to enter the time (in minutes) for the section you want.

To enter 10 minutes: Press 1 and 10/0.

The selected elapsed time appears on the TV screen.

To reenter the time: Press CLEAR and then press the number buttons again.

- 4 Press ►.

Playback starts from the selected time.

Locating the desired track

— *Disc Digest*

You can select the track you want by viewing the first frame of each track. 9 different tracks can be displayed on the TV screen at one time.

1 Press SPECIAL MENU in stop mode.

2 Press 2 to select “2) DISC DIGEST”.

The first frame of tracks 1 through 9 on the current disc are displayed.

3 Press the number buttons (1 – 9) to select the track you want.

To display the next 9 tracks

Press NEXT. The first frame of tracks 10 through 18 are displayed.

When there are more tracks in the disc, “▶▶” appears in the upper right corner of the TV screen.

To display previous tracks, press PREV.

Note

If you press SPECIAL MENU to active Time Search or Disc Digest in Program or Shuffle Play mode, it changes to Normal Play mode.

Presetting radio stations

You can preset up to 20 FM stations and 10 AM stations. You can then tune in any of those stations simply by selecting the corresponding preset number.

Automatic tuning preset

You can automatically tune in all of the stations that can be received in your area and then store the radio frequency of the desired stations.

- 1 Press **TUNER/BAND** repeatedly to select “FM” or “AM”.
- 2 Press and hold **TUNING -/+** (or **-◀◀** or **▶▶+** on the unit) until the frequency indication starts to change, then release it.

The frequency changes as the system scans for a station. Scanning stops automatically when a station is tuned in. At that time, “TUNED” and “STEREO” (for an FM stereo program) appear.

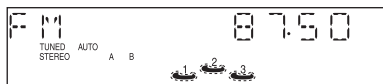

If “TUNED” does not appear and the scanning does not stop

Set the frequency of the desired radio station as described in steps 2 through 6 of “Manual tuning preset” (page 16).

- 3 Press **TUNER MEMORY**.

A preset number appears.

Preset number



- 4 Press **PRESET -/+** (or **◀◀** or **▶▶** on the unit) repeatedly to select the desired preset number.
- 5 Press **ENTER**.
“COMPLETE” appears.
- 6 Repeat steps 1 through 5 to store other stations.

Manual tuning preset

You can manually tune in and store the radio frequency of the desired stations.

- 1 Press **TUNER/BAND** repeatedly to select “FM” or “AM”.
- 2 Press **TUNING -/+** (or **-◀◀** or **▶▶+** on the unit) repeatedly to tune in the desired station.
- 3 Press **TUNER MEMORY**.
A preset number appears.
- 4 Press **PRESET -/+** (or **◀◀** or **▶▶** on the unit) repeatedly to select the desired preset number.
- 5 Press **ENTER**.
“COMPLETE” appears.
- 6 Repeat steps 1 through 5 to store other stations.

Other operations

To	Do this
Tune in a station with a weak signal	Follow the procedure described in "Manual tuning preset" (page 16).
Set another station to the existing preset number	Start over from step 1. After step 3, press PRESET \rightarrow /+ (or \blacktriangleleft or \blacktriangleright on the unit) repeatedly to select the preset number you want to store the other station.

To improve tuner reception

When tuner reception is poor, set CD player power off by CD power manage function. CD power is factory set to on.

- 1 Press CD.
- 2 Press I/⏻ to turn off the system.
- 3 Press I/⏻ while holding ■. "CD POWER OFF" appears.

To set CD power on

Repeat the procedure above and "CD POWER ON" appears.

Notes

- When "CD POWER OFF" is selected, disc access time is increased.
- You cannot change the setting in Power Saving Mode.

To change the AM tuning interval (except for Middle Eastern model)

The AM tuning interval is factory-preset to 9 kHz (or 10 kHz for some areas). To change the AM tuning interval, tune in any AM station first, then turn off the system. While holding TUNER/BAND on the unit, press I/⏻ on the unit. When you change the interval, all the AM preset stations are erased. To reset the interval, repeat the same procedure.

Note

You cannot change the AM tuning interval in Power Saving Mode.

Tips

- The preset stations are retained for half a day even if you disconnect the power cord or if a power failure occurs.
- To improve the reception, adjust the supplied antennas or connect an external antenna.

Listening to the radio

You can listen to a radio station either by selecting a preset station, or by manually tuning in the station.

Listening to a preset station

— Preset Tuning

Preset radio stations in the tuner's memory first (see "Presetting radio stations" on page 16).

- 1 Press TUNER/BAND repeatedly to select "FM" or "AM".**
- 2 Press PRESET $-/+$ (or \lll or \ggg) on the unit) repeatedly to select the desired preset station.**

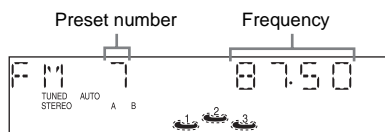

Listening to non-preset radio station

— Manual Tuning

- 1 Press TUNER/BAND repeatedly to select "FM" or "AM".**
- 2 Press TUNING $-/+$ (or \lll or \ggg) on the unit) repeatedly to tune in the desired station.**

Note

When "TUNER" is selected as the current function and CD is pressed to select CD during "CD POWER OFF", it may take some time to switch the function (page 17).

Tips

- To improve broadcast reception, adjust the supplied antennas, or connect a commercially available external antenna.
- When an FM stereo program has static noise, press FM MODE repeatedly until "MONO" appears. There will be no stereo effect, but the reception will improve.
- Press and hold TUNING $-/+$ (or \lll or \ggg) on the unit). The frequency indication changes and scanning stops when the system tunes in a station (Automatic Tuning).
- To record the radio programs, use manual recording (page 20).

Loading a tape

- 1 Press **TAPE A/B** repeatedly to select deck A or B.
- 2 Press **▲ PUSH** or **PUSH ▲** on the unit.
- 3 Load a recorded/recordable tape in deck A or B with the side you want to play/record facing forward.

With the side you want to play/record facing forward.

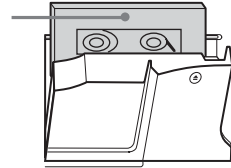

Playing a tape

You can use TYPE I (normal) tape.

- 1 Load a tape.
- 2 Press **TAPE A/B**.
- 3 Press **PLAY MODE** repeatedly to select “RELAY OFF” to play one side. Select “RELAY ON” (Relay Play)* to play both decks in succession.
- 4 Press **▶**.
The tape starts playing.



* Relay play follow this cyclic sequence:
the front side of deck A → the front side of deck B → stop automatically.

Other operations

To	Do this
Stop play	Press ■ .
Pause	Press ⏸ . Press again to resume play.
Fast-forward or rewind	Press ⏩ or ⏪ .
Remove a tape	Press ▲ PUSH or PUSH ▲ on the unit.

Searching for the beginning of the current or the next track (AMS)*

To go forward

Press **▶▶▶** during playback.

“TAPE A (or TAPE B) >>> +1” appears.

To go back

Press **◀◀◀** during playback.

“TAPE A (or TAPE B) <<<< -1” appears.

* AMS (Automatic Music Sensor)

Note

The AMS function may not operate correctly under the following circumstances:

- When the unrecorded space between songs is less than 4 seconds long.
- When the system is placed near a television.

Recording your favorite CD tracks on a tape

— CD Synchro Recording

You can record a whole CD on a tape. You can use TYPE I (normal) tape. The recording level is adjusted automatically.

- 1 Load a recordable tape into deck B.**
- 2 Press CD and load a disc you want to record.**
- 3 Press CD SYNC on the unit.**
Deck B stands by for recording.
“REC” flashes.
- 4 Press REC PAUSE/START on the unit.**
Recording starts.

To stop recording

Press ■.

To record a disc by specifying track order

You can record only your favorite disc tracks using Program Play. Between steps 2 and 3, perform steps 2 to 6 of “Creating your own program” (page 13).

Tip

When setting the PBC function to on, change the setting to off and then start recording.

Recording on a tape manually

— Manual Recording

You can record just the portions you like from a CD, tape or radio program on a tape.

You can also record from connected components (see “Hooking up optional components” on page 29).

- 1 Load a recordable tape into deck B.**
- 2 Press CD, TAPE A/B, TUNER/BAND or GAME to select the desired source to record.**
 - CD: To record from this system’s CD player.
 - TAPE A: To record from this system’s tape deck A.
 - TUNER: To record from this system’s tuner.
 - GAME: To record from the connected video game machine to GAME INPUT AUDIO L/R jacks.
- 3 Press REC PAUSE/START on the unit.**
Deck B stands by for recording.
“REC” flashes.
- 4 Press REC PAUSE/START on the unit, then start playing the desired source to record.**
Recording starts.

To stop recording

Press ■.

Notes

- You cannot listen to other sources while recording.
- If TAPE B is selected in step 2, silence is recorded.

Tip

For recording from the tuner:

If noise is heard while recording from the tuner, move the respective antenna to reduce the noise.

Sound Adjustment

Adjusting the sound

You can reinforce the bass and create a more powerful sound.

Press GROOVE.

Each time you press the button, the display changes cyclically as follows:

GROOVE ON* → V-GROOVE ON* → GROOVE OFF

* The volume switches to power mode, the equalizer curve changes, and the “GROOVE” or “V GROOVE” lights up.

Selecting the sound effect

You can select the sound effect from the music menu.

Press PRESET EQ (or MUSIC EQ, MOVIE EQ or GAME EQ on the unit) repeatedly to select the preset you desire.

The preset name appears in the display. See the chart “Sound effect options”.

To cancel the sound effect

Press EFFECT ON/OFF repeatedly until “EFFECT OFF” appears.

Sound effect options

“SURR” appears if you select an effect with surround effects.

MUSIC EQ

Effect

ROCK	Standard music sources
POP	

MOVIE EQ

Effect

MOVIE	Soundtracks and special listening situations
-------	--

GAME EQ

Effect

GAME	PlayStation 1, 2 and other video game music sources
------	---

Selecting the surround effect

Press **SURROUND**.

Each time you press the button, the display changes as follows:

SURROUND ON (SURR)



SURROUND OFF

Enhancing video game sound

— *Game Sync*

You need to connect a video game machine (see “Hooking up optional components” on page 29).

Press **GAME**.

Tips

- In the standby mode, the system automatically turns on.
- The GAME EQ is automatically selected.
- These operations cannot be performed in Power Saving Mode.

Mixing video game sound with other sound source

— *Game Mixing*

1 Select the desired sound source.

2 Press **GAME MIXING** on the unit.

Each time you press the button, the display changes cyclically as follows:

MIXING LOW → MIXING MID →
MIXING HIGH → MIXING OFF

Notes

- If you start recording while Game Mixing is activated, Game Mixing is canceled. To record the mixed sound, press GAME MIXING on the unit after step 3 of “Recording on a tape manually” on page 20, and then press REC PAUSE/START on the unit to start the recording.
- This system outputs the video signal from the GAME INPUT jack while GAME MIXING is activated.

Tips

- The GAME MIXING indicator lights up while Game Mixing is activated.
- Once Game Mixing is activated, it will remain active while the power is on even if the sound source is changed.

Singing along

You can sing along by connecting an optional microphone.

Enjoying Karaoke

- 1 Turn MIC LEVEL on the unit to MIN to turn down the microphone control level.**
- 2 Connect an optional microphone to MIC jack.**
- 3 Press KARAOKE/MPX repeatedly to obtain the karaoke effect you desire.**
Each time you press the button, the display changes cyclically as follows:
KARAOKE PON → MPX L → MPX R → KARAOKE OFF (effect status)
To sing karaoke of multiplex CD, select “MPX L” or “MPX R”.
- 4 Start playing the music.**
- 5 Adjust the microphone volume by turning MIC LEVEL on the unit.**

Other operations

To	Do this
Use VIDEO CDs	Turn on your TV and switch it to the appropriate video input.
Cancel karaoke mode	Turn MIC LEVEL on the unit to MIN and disconnect the microphone from MIC, then press KARAOKE/MPX repeatedly until “  ” disappears.
Adjust the microphone echo	Turn ECHO LEVEL on the unit to adjust the echo effect. To cancel the echoing, turn ECHO LEVEL on the unit to MIN.
Adjust the key*	Press KEY CONTROL # or \flat to suit your vocal range. You can adjust the key higher or lower in 13 halftone steps ($\flat 6$ – #6).

* This function is not available on MP3 audio tracks.

Notes

- With some songs, vocals may not be canceled when you select “KARAOKE PON”.
- During KARAOKE PON, equalizer and surround settings cannot be changed.
- If you press PRESET EQ (or MUSIC EQ, MOVIE EQ, GAME EQ or EFFECT ON/OFF on the unit) or recall a sound effect, the karaoke mode is canceled.
- The instrumental sound may be reduced as well as the singer’s voice when the sound is recorded in monaural.
- The singer’s voice may not be reduced when:
 - only a few instruments are playing.
 - a duet is being played.
 - the source has strong echoes or chorus.
 - the singer’s voice deviates from the center.
 - the voice on the source is singing in high soprano or tenor.

Mixing and recording sounds

- 1 Prepare the sound source you want to mix. Then, load a recordable tape in deck B.**
- 2 Press the function button of the source you want to record.**
When you want to record from TAPE A, press TAPE A/B repeatedly until TAPE A is selected.
- 3 Press REC PAUSE/START on the unit.**
Deck B stands by for recording.
“REC” flashes.
- 4 Press REC PAUSE/START on the unit and then press  to start playing the source to be recorded.**
Start singing along with the music.

To stop recording

Press .

Tips

- If acoustic feedback (howling) occurs, move the microphone away from the speakers or change the direction of the microphone.
- If you want to record your voice through the microphone only, you can do so by selecting the CD function and not playing a disc.
- When high level sound signals are input, the system automatically adjusts the recording level to prevent distortion of the recorded sound signal (Auto Level Control function).

Falling asleep to music

— Sleep Timer

You can set the system to turn off after a certain time, so that you can fall asleep to music.

Press SLEEP.

Each time you press the button, the minute display (the turn-off time) changes cyclically as follows:

AUTO* → 90MIN → 80MIN → 70MIN
→ ... → 10MIN → OFF

* The system automatically turns off in 100 minutes or after the current disc or tape finishes playing.

Other operations

To	Press
Check the remaining time**	SLEEP once.
Change the time to turn off	SLEEP repeatedly to select the time you want.
Cancel the Sleep Timer Function	SLEEP repeatedly until "SLEEP OFF" appears.

** You cannot check the remaining time if you select "AUTO".

Note

Do not set to "AUTO" during Synchro Recording on a tape.

Tip

You can use the Sleep Timer, even if you have not set the clock.

Waking up to music

— Daily Timer

You can wake up to music at a preset time. Make sure you have set the clock (see "Setting the clock" on page 8).

1 Prepare the sound source you want to play.

- CD: Load a disc. To start from a specific track, make a program (see "Creating your own program" on page 13).
- TAPE: Load a tape.
- TUNER: Tune in the preset radio station (see "Listening to the radio" on page 18).

2 Press VOL +/- (or turn VOLUME control on the unit) to adjust the volume.

3 Press CLOCK/TIMER SET until "DAILY SET" appears.

4 Press ENTER.

"ON" appears and the hour indication flashes.

5 Set the time to start playing.

Press \uparrow or \downarrow repeatedly to set the hour, then press \rightarrow .

The minute indication flashes.

Press \uparrow or \downarrow repeatedly to set the minute, then press ENTER.

6 Set the time to stop playing following the same procedure as step 5.

7 Press \uparrow or \downarrow repeatedly until the desired sound source appears.

Each time you press the button, the display changes cyclically as follows:



8 Press ENTER.

The type of timer ("DAILY"), the start time, the stop time, and the sound source appear in turn, before the original display returns.

9 Press I/⏻ to turn off the system.

Other operations

To	Do this
Check the setting	<ol style="list-style-type: none">1 Press CLOCK/TIMER SELECT.2 Press ↑ or ↓ repeatedly until “DAILY” appears, then press ENTER.
Change the setting	Start over from step 1.
Cancel the timer	<ol style="list-style-type: none">1 Press CLOCK/TIMER SELECT.2 Press ↑ or ↓ repeatedly until “TIMER OFF” appears, then press ENTER.

Notes

- You cannot activate the Daily Timer and timer recording at the same time.
- If you use the Daily Timer and the Sleep Timer at the same time, the Sleep Timer has priority.
- If the system is on at the preset time, the Daily Timer will not be activated.

Tip

The system turns on 15 seconds before the preset time.

Timer recording radio programs

You can record a preset radio station from a specified time.

To timer record, you must first preset the radio station (see “Presetting radio stations” on page 16) and set the clock (see “Setting the clock” on page 8).

- 1 Tune in the preset radio station (see “Listening to a preset station” on page 18).**
- 2 Press **CLOCK/TIMER SET**.**
“DAILY SET” appears.
- 3 Press **↑** or **↓** repeatedly to select “REC SET”, then press **ENTER**.**
“ON” appears and the hour indication flashes.
- 4 Set the time to start recording.**
Press **↑** or **↓** repeatedly to set the hour, then press **→**.
The minute indication flashes.
Press **↑** or **↓** repeatedly to set the minute, then press **ENTER**.
- 5 Set the time to stop recording following the same procedure as step 4.**
The start time, the stop time, and the preset radio station to be recorded (e.g., “TUNER FM 5”) appear in turn, before the original display returns.
- 6 Load a recordable tape into deck B.**
- 7 Press **I/⏻** to turn off the system.**

Other operations

To	Do this
Check the setting	<ol style="list-style-type: none">1 Press CLOCK/TIMER SELECT.2 Press ↑ or ↓ repeatedly until “REC SELECT” appears, then press ENTER.
Change the setting	Start over from step 1.
Cancel the timer	<ol style="list-style-type: none">1 Press CLOCK/TIMER SELECT.2 Press ↑ or ↓ repeatedly until “TIMER OFF” appears, then press ENTER.

Notes

- You cannot activate the Daily Timer and timer recording at the same time.
- If you use the timer recording and the Sleep Timer at the same time, the Sleep Timer has priority.
- If the system is on at the preset time, the timer recording will not be activated.
- The volume is reduced to minimum during recording.

Tip

The system turns on 15 seconds before the preset time.

Display

Turning off the display

— Power Saving Mode

The demonstration display (display window and buttons lighting and flashing even when the system power is off) and the clock display can be turned off to minimize the amount of power consumed during standby (Power Saving Mode).

Press DISPLAY repeatedly while the system is off until the demonstration display or the clock display disappears.

To cancel Power Saving Mode

Press DISPLAY while the system is off. Each time you press the button, the display switches cyclically as follows:

Demonstration display → Clock display* → No display (Power Saving Mode)

* “-:-” is displayed if you do not set the clock.

Note

You cannot perform the following operations in Power Saving Mode.

- setting the clock
- changing the AM tuning interval (except for Middle Eastern model)
- turning on the system by pressing the function buttons
- changing the CD power manage function
- changing the color system (page 7)

Tips

- The timer continues to operate in Power Saving Mode.
- I/⏻ indicator lights up even in Power Saving Mode.

Viewing information about the disc in the display

You can check the playing time and remaining time of the current track or that of the disc.

Checking the remaining time and titles (VIDEO CD/CD/MP3)

Press DISPLAY during Normal Play.

Each time you press the button, the display changes cyclically as follows:

■ When playing a CD/MP3/VIDEO CD without PBC function (Ver. 1.1)

Elapsed playing time of the current track →
Remaining time of the current track^{*1} →
Remaining time of the current disc^{*2} →
Track title of CD-TEXT disc^{*3} or track name of MP3 audio track → Album name of MP3 audio track (for a few seconds) → Clock display (for eight seconds) → Effect status

^{*1} “_ _ _ _” appears when playing back MP3 audio tracks.

^{*2} “_ _ _ _” appears in ALL DISCS, SHUFFLE or program play mode or when playing back MP3 audio tracks.

^{*3} When the disc contains more than 20 tracks, CD-TEXT is not displayed from track 21 on.

■ When playing a VIDEO CD with PBC function (Ver. 2.0)

Elapsed playing time of the current track* →
Clock display (for eight seconds) →
Effect status

* The elapsed playing time may not be displayed in some cases such as during still image playback.

Checking the total playing time and titles (VIDEO CD/CD/MP3)

Press DISPLAY in stop mode.

Each time you press the button, the display changes cyclically as follows:

■ When a CD/MP3/VIDEO CD is in Normal Play mode

TOC display^{*1} or total album number of the disc^{*2} or total number of the current album^{*2} → Disc title^{*3} or Album name^{*2} → Clock display (for eight seconds) → Effect status

^{*1} TOC = Table of Contents; displays current disc number, total number of tracks on the disc, and total playing time of the disc.

^{*2} For discs with MP3 audio tracks.

^{*3} For CD-TEXT discs (certain characters cannot be displayed) and discs with MP3 audio tracks. For a MP3 audio disc, either the Disc title or Album name of the current disc is displayed.

Notes

- The total playing time is not displayed for a disc with MP3 audio tracks.
- ID3 tag applies to version 1 (1.0 or 1.1).
- If the MP3 audio track you play back has an ID3 tag, the ID3 tag information is displayed as a track title.
- In the following case, elapsed playing time and remaining time of the track may not be displayed accurately.
 - when an MP3 audio track of VBR (variable bit rate) is played.
 - when fast forward or fast reverse is performed.

Viewing information about the disc in the on-screen display

You can check the current operating status and disc information of VIDEO CDs or audio CDs during playback or in stop mode. Depending on conditions, some items are displayed and others are not.

Press ON SCREEN.

Each time you press this button, the on-screen display changes cyclically as follows:

ON SCREEN 1 → ON SCREEN 2 →
ON SCREEN OFF*

* No display (except for Time Search/Disc Digest)

ON SCREEN display 1, 2 in stop mode

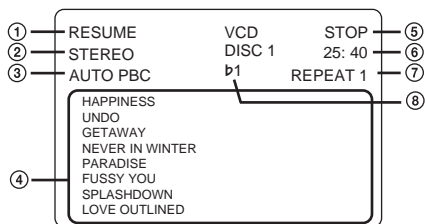

①

While the deck is: Displayed

In stop mode	“RESUME” or no display
During playback	Current disc and track number

② “STEREO”, “KARAOKE PON”, “MPX L” or “MPX R”

③ Play mode or “AUTO PBC”*

(Ⓢ): All discs/Ⓣ: One disc/□: Album)

*“AUTO PBC” appears for a VIDEO CD with PBC functions.

④

While the deck is: Displayed

In stop mode of a MP3 audio tracks*	Album name
In Program Play mode	Programed disc and track number
During playback of a MP3 audio tracks*	Current album name and track name
In other conditions	No display

* When the MP3 audio track information includes an ID3 tag, the on-screen display information may differ from the ID3 information shown on the system display in order to display the track name.

⑤

While the deck is: Displayed

During playback	Elapsed time of the current track
In stop mode	“STOP”

⑥

While the deck is: Displayed

In stop mode	Total playing time of the current disc*
In Program Play mode	Total playing time of the program

* “- : -” appears for a disc with MP3 audio tracks.

⑦ “REPEAT”, “REPEAT 1” or no display

⑧ Key control level or no display

Notes

- Check to make sure that ON SCREEN OFF is selected when recording a video signal played back by this system onto a video tape, etc. Otherwise the display information will also be recorded onto the video tape.
- Noise may be heard when switching the on-screen display.

Optional Components

Hooking up optional components

To enhance your system, you can connect optional components. Refer to the operating instructions provided with each component.

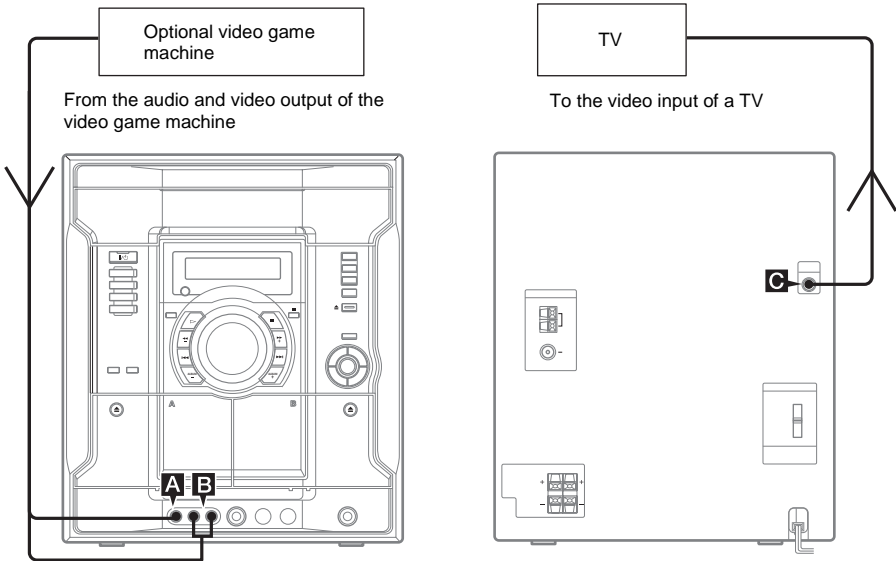

A GAME INPUT VIDEO jack

Use a video cable (not supplied) to connect the video output of the optional video game machine to this jack.

B GAME INPUT AUDIO L/R jacks

Use audio cords (not supplied) to connect the audio output of the optional video game machine to these jacks. You can then output audio through this system.

C VIDEO OUT jack

Use the supplied video cable to connect the video input of TV to this jack.

Notes

- The video game machine image may appear on the TV screen even if the system is turned off.
- See “Selecting the surround effect” on page 22 for video game sound effects.
- If you press GAME while the system is off, the system turns on, the function switches to GAME, and the equalizer also switches to the GAME EQ.
- If you press GAME while the system is on, the function switches to GAME and the equalizer automatically switches to the GAME EQ in the same manner.

Troubleshooting

Problems and remedies

Should you encounter a problem with your system, do the following:

- 1 Make sure the power cord and speaker cords are correctly and firmly connected.
- 2 Find your problem in the troubleshooting checklist below and take the indicated corrective action.

If the problem persists after doing all of the above, consult your nearest Sony dealer.

When the I/⏻ indicator flashes

Immediately unplug the power cord and check the following items.

- Is the voltage selector set to the correct voltage?
Check the voltage for your region, then make sure the voltage selector is set correctly.
- Are the + and – speaker cords short-circuited?
- Are you using only the prescribed speakers?
- Is anything blocking the ventilation holes on the rear of the system?

Check all the above items and fix any problems found. After I/⏻ indicator stops flashing, reconnect the power cord and turn on the system. If the indicator still flashes, or if the cause of the problem cannot be found even after checking all the above items, consult your nearest Sony dealer.

General

The display starts flashing as soon as you plug in the power cord even though you have not turned on the system (see step 5 of “Hooking up the system” (page 6)).

- Press DISPLAY twice while the system is off. The demonstration disappears.

“- -: -” appears in the display.

- A power interruption has occurred. Set the clock (page 8) and timer settings (pages 24 and 25) again.

The clock setting/radio presetting/timer is canceled.

- Redo the following:
 - “Setting the clock” (page 8)
 - “Presetting radio stations” (page 16)
 - “Check the setting” (page 25)
 - “Timer recording radio programs” (page 25)

There is no sound.

- Press VOL +/- or turn VOLUME control on the unit clockwise.
- Make sure the headphones are not connected.
- Check the speaker connections (page 6).
- There is no audio output during timer recording.

There is no microphone sound.

- Press VOL +/- (or turn VOLUME on the unit) or turn MIC LEVEL on the unit to adjust the microphone volume.
- Make sure the microphone is connected to the MIC jack on the unit correctly.

Sound comes from one channel, or unbalanced left and right volume.

- Place the speakers as symmetrically as possible.
- Connect the supplied speakers.

Sound lacks bass.

- Check that the speaker’s + and – jacks are connected correctly.

There is severe hum or noise.

- Move the system away from the source of noise.
- Connect the system to a different wall outlet.
- Install a noise filter (commercially available) to the mains line.

The timer cannot be set.

- Set the clock again (page 8).

The timer does not function.

- Check the timer setting and set the correct time (pages 25 and 26).
- Cancel the Sleep Timer Function (page 24).

The remote does not function.

- Remove the obstacle.
- Move the remote closer to the system.
- Point the remote at the system’s sensor.
- Replace the batteries (R6/size AA).
- Locate the system away from the fluorescent light.

There is acoustic feedback.

- Reduce the volume.
- Move the microphone away from the speakers or change the direction of the microphone.

The color irregularity on a TV screen persists.

- Turn off the TV set once, then turn it on after 15 to 30 minutes. If the color irregularity still persists, place the speakers farther away from the TV set.
-

VIDEO CD/CD/MP3 player



The disc tray does not open and “LOCKED” appears.

- Contact your Sony dealer or local authorized Sony service facility.
-

The disc tray does not close.

- Place the disc correctly.
 - Always close the tray by pressing  on the unit. Trying to press the tray closed with your fingers may cause problems with the player.
-

The disc does not eject.

- You cannot eject the disc during CD Synchro Recording. Press  to cancel the CD Synchro Recording, then press  on the unit to eject the disc.
 - Consult your nearest Sony dealer.
-

There is no picture.

- Check that the player is connected securely.
 - Make sure you operate the TV correctly.
 - Make sure you set the color system correctly, according to your TV (color) system.
 - Press CD.
 - Make sure that GAME MIXING is canceled.
-

Play does not start.

- Open the disc tray and check whether a disc is loaded.
 - Wipe the disc clean (page 34).
 - Replace the disc.
 - Place the disc that this system can play (page 4).
 - Place the disc correctly.
 - Place the disc in the tray with the label side up.
 - Remove the disc and wipe away the moisture on the disc, then leave the system turned on for a few hours until the moisture evaporates.
 - Press  to start play.
-

Disc access takes a long time.

- Set “CD POWER ON” by CD power manage function (page 17).
-

The sound skips.

- Wipe the disc clean (page 34).
 - Replace the disc.
 - Try moving the system to a place without vibration (e.g., on top of a stable stand).
 - Try moving the speakers away from the system, or placing them on separate stands. When you listen to a track with bass sounds at high volume, the speaker vibration may cause the sound to skip.
-

Play does not start from the first track.

- Press PLAY MODE repeatedly until both “PGM” and “SHUF” disappear to return to Normal Play.
-

MP3 audio track cannot be played back.

- Recording was not performed according to the ISO 9660 level 1 or level 2 format or Joliet in the expansion format.
 - The MP3 audio track does not have the extension “.MP3”.
 - The file is not stored in MP3 format.
 - Discs containing files other than MPEG 1 Audio Layer-3 files cannot be played.
 - Files that are too small (64 kB or less) cannot be played back.
-

MP3 audio tracks take longer to begin play back than others.

- After the system reads all tracks on the discs, playback may take more time than usual if:
 - the number of albums or tracks on the disc is very large.
 - the album and track organization structure is very complex.
-

The album title, track title, ID3 tag, and the CD-TEXT characters do not appear correctly.

- Use a disc that conforms with ISO 9660 level 1, level 2 or Joliet in the expansion format.
 - The disc ID3 tag is not ver. 1 (ver. 1.0 or 1.1).
 - The characters that can be displayed by this unit are as follows:
 - Upper cases (A to Z)
 - Numbers (0 to 9)
 - Symbols (<> * + , - / [] \ _)
 Other characters may not be displayed correctly.
-

Tuner

Severe hum or noise/stations cannot be received.

- Set the proper band and frequency (page 16).
- Connect the antenna properly (page 6).
- Find a place and an orientation that provide good reception, then set up the antenna again. If you cannot obtain good reception, we recommend you connect a commercially available external antenna.
- The supplied FM lead antenna receives signals along its entire length, so make sure you extend it fully.
- Locate the antennas as far away from the speaker cords as possible.
- Try turning off surrounding electrical equipment.
- Set “CD POWER OFF” by CD power manage function (page 17).

A stereo FM program cannot be received in stereo.

- Press FM MODE until “MONO” disappears.
-

Tape deck

The tape does not record or play, or there is a decrease in sound level.

- The heads are dirty. Clean them (page 35).
- The record/playback heads are magnetised. Demagnetise them (page 35).

The tape does not erase completely.

- The record/playback heads are magnetised. Demagnetise them (page 35).

There is excessive wow or flutter, or the sound drops out.

- The capstans or pinch rollers are dirty. Clean them (page 35).

Noise increases or the high frequencies are erased.

- The record/playback heads are magnetised. Demagnetise them (page 35).

The tape does not record.

- No cassette is loaded. Load a cassette.
 - The tab has been removed from the cassette. Cover the broken tab with adhesive tape (page 35).
 - The tape has wound to the end.
-

If the system still does not operate properly after performing the above measures, reset the system as follows:

- 1 Disconnect the power cord.
- 2 Reconnect the power cord.
- 3 Press **■**, GROOVE and DISPLAY at the same time.
- 4 Press I/⏻ to turn on the system.

The system is reset to the factory settings. You should set the settings you made, such as the preset stations, clock, and timer.

Messages

One of the following messages may appear or flash in the display during operation.

VIDEO CD/CD/MP3

CANNOT USE

You pressed an invalid button.

NO DISC

There is no disc in the player or you have loaded a disc that cannot be played on this system (such as DVD or CD-ROM without MP3 audio tracks, etc.).

OVER

You have reached the end of the disc or the end of MP3 audio track while pressing ►► during playback or pause.

PUSH STOP

You pressed an invalid button during playback.

STEP FULL

You tried to program 26 or more tracks (steps).

READING

The system is reading the TOC information of the disc. Some buttons are not available.

Additional Information

Precautions

On operating voltage

Before operating the system, check that the operating voltage of your system is identical with the voltage of your local power supply.

On safety

- The unit is not disconnected from the AC power source (mains) as long as it is connected to the wall outlet, even if the unit itself has been turned off.
- Unplug the system from the wall outlet (mains) if it is not to be used for an extended period of time. To disconnect the power cord (mains lead), pull it out by the plug. Never pull the cord itself.
- Should any solid object or liquid fall into the system, unplug the system and have it checked by qualified personnel before operating it any further.
- AC power cord must be changed only at the qualified service shop.

On placement

- Do not place the system in an inclined position.
- Do not place the system in locations where it is:
 - Extremely hot or cold
 - Dusty or dirty
 - Very humid
 - Subject to vibrations
 - Subject to direct sunlight.
- Use caution when placing the unit or speakers on surfaces that have been specially treated (with wax, oil, polish, etc.) as staining or discoloration of the surface may result.

On heat buildup

- Although the system heats up during operation, this is not a malfunction.
- Place the system in a location with adequate ventilation to prevent heat buildup in the system.
- If you continuously use this system at a high volume, the cabinet temperature of the top, side and bottom rises considerably. To avoid burning yourself, do not touch the cabinet.
- To prevent a malfunction, do not cover the ventilation hole for the cooling fan.

On operation

- If the system is brought directly from a cold to a warm location, or is placed in a very damp room, moisture may condense on the lens inside the CD player. Should this occur, the system will not operate properly. Remove the disc and leave the system turned on for about an hour until the moisture evaporates.
- When you move the system, take out any disc.

If you have any questions or problems concerning your system, please consult your nearest Sony dealer.

Notes on discs

- Before playing, clean the disc with a cleaning cloth. Wipe the disc from the center out.
- Do not expose the disc to direct sunlight or heat sources such as hot air ducts, nor leave it in a car parked in direct sunlight.
- When using discs that have glue or similar tacky substance on the label side of the disc or that used a special ink when the label was printed, there is a chance that the disc or label may become attached to parts inside this unit. When this occurs, it may not be possible to remove the disc, and may also cause this unit to malfunction. Be sure to check that the label side of the disc is not sticky before using.
The following types of disc should not be used:
 - Rental or used discs with attached seals where the glue extends beyond the seal. The perimeter of the seal on the disc is tacky.
 - Discs that have labels printed using a special ink that feels tacky when touched.
- Discs with non-standard shapes (e.g., heart, square, star) cannot be played on this unit. Attempting to do so may damage the unit. Do not use such discs.

Cleaning the cabinet

Clean the cabinet, panel and controls with a soft cloth slightly moistened with mild detergent solution. Do not use any type of abrasive pad, scouring powder or solvent such as thinner, benzene or alcohol.

To save a tape permanently

To prevent a tape from being accidentally recorded over, break off the cassette tab from side A or B as illustrated.

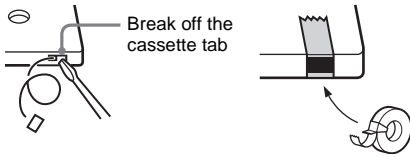

If you later want to reuse the tape for recording, cover the broken tab with adhesive tape.

Before placing a cassette in the tape deck

Take up any slack in the tape. Otherwise, the tape may get entangled in the parts of the tape deck and become damaged.

When using a tape longer than 90 minutes

The tape is very elastic. Do not change the tape operations such as play, stop, and fast-winding frequently. The tape may get entangled in the tape deck.

Cleaning the tape heads

Clean the tape heads after every 10 hours of use. Be sure to clean the tape heads before you start an important recording or after playing an old tape. Use a separately sold dry-type or wet-type cleaning cassette. For details, refer to the instructions of the cleaning cassette.

Demagnetising the tape heads

Demagnetise the tape heads and the metal parts that have contact with the tape after every 20 to 30 hours of use with a separately sold demagnetising cassette. For details, refer to the instructions of the demagnetising cassette.

Specifications

Amplifier section

The following measured at AC 120, 127, 220, 240 V
50/60 Hz

DIN power output (rated): 80 + 80 watts
(6 ohms at 1 kHz, DIN)

Continuous RMS power output (reference):
100 + 100 watts
(6 ohms at 1 kHz, 10% THD)

Inputs

GAME INPUT AUDIO L/R (phono jacks):
voltage 250 mV,
impedance 47 kilohms

GAME INPUT VIDEO (phono jack):

1Vp-p, 75 ohms
MIC (phone jack): sensitivity 1 mV,
impedance 10 kilohms

Outputs

PHONES (stereo mini jack):
accepts headphones of
8 ohms or more

VIDEO OUT (phono jack):

max. output level 1Vp-p,
unbalanced, Sync
negative, load impedance
75 ohms
SPEAKER: accepts impedance of 6 to
16 ohms.

CD player section

System Compact disc and digital
audio system

Laser Semiconductor laser
($\lambda=780$ nm)

Emission duration:
continuous

Frequency response 2 Hz – 20 kHz (± 0.5 dB)

Wavelength 780 – 790 nm

Signal-to-noise ratio More than 90 dB

Dynamic range More than 90 dB

Video color system format

NTSC, PAL

Tape deck section

Recording system 4-track 2-channel, stereo
Frequency response 50 – 13,000 Hz (± 3 dB),
using Sony TYPE I
cassettes

Wow and flutter $\pm 0.15\%$ W. Peak (IEC)
0.1% W. RMS (NAB)
 $\pm 0.2\%$ W. Peak (DIN)

Tuner section

FM stereo, FM/AM superheterodyne tuner

FM tuner section

Tuning range 87.5 – 108.0 MHz
Antenna FM lead antenna
Antenna terminals 75 ohms unbalanced
Intermediate frequency 10.7 MHz

AM tuner section

Tuning range
Middle Eastern model: 531 – 1,602 kHz
(with the tuning interval set at 9 kHz)
Other models: 530 – 1,710 kHz
(with the tuning interval set at 10 kHz)
531 – 1,602 kHz
(with the tuning interval set at 9 kHz)
Antenna AM loop antenna
Antenna terminals External antenna terminal
Intermediate frequency 450 kHz

Speaker

Speaker system 3-way, 3-unit,
bass-reflex type
Speaker units
Woofers: 13 cm, cone type
Sub woofer: 13 cm, cone type
Tweeter: 5 cm, cone type
Nominal impedance 6 ohms
Dimensions (w/h/d) Approx. 240 × 325 ×
243 mm
Mass Approx. 4.3 kg net per
speaker

General

Power requirements
Saudi Arabian model: 120 – 127/220 or
230 – 240 V AC, 50/60 Hz
Adjustable with voltage selector
Thai model: 220 V AC, 50/60 Hz
Other models: 120 V, 220 V or
230 – 240 V AC, 50/60 Hz
Adjustable with voltage selector
Power consumption 110 watts
Dimensions (w/h/d) Approx. 280 × 325 ×
407 mm
Mass Approx. 8.5 kg

Supplied accessories: Remote Commander (1)
Batteries (2)
AM loop antenna (1)
FM lead antenna (1)
Speaker pads (8)
Video cable (1)

Design and specifications are subject to change without notice.

Glossary

Album

Section of a music piece or an image on a data CD containing MP3 audio tracks.

Auto Pause

An automatical pauses according to the signal encoded on the disc while playing a VIDEO CD. If the CD player does not resume play for a long time, press ► to resume play manually.

Menu Playback

Playback using the menu screens recorded on VIDEO CDs with PBC functions. You can enjoy simple interactive software using the menu playback function.

Playback Control (PBC)

Signals encoded on VIDEO CDs (Ver. 2.0) to control playback. By using menu screens recorded on VIDEO CDs with PBC functions, you can enjoy playing simple interactive programs, programs with search functions, and so on.

This system conforms to Ver. 1.1 and Ver. 2.0 of VIDEO CD standards. You can enjoy two kinds of playback depending on the disc type.

VIDEO CDs without PBC functions (Ver. 1.1 discs)

Enjoy video playback (moving pictures) as well as music.

VIDEO CDs with PBC functions (Ver. 2.0 discs)

Play interactive software using menu screens displayed on the TV screen (PBC Playback), in addition to the video playback functions of Ver. 1.1 discs. Moreover, you can play high-resolution still pictures, if they are included on the disc.

Scene

On a VIDEO CD with PBC (playback control) functions, the menu screens, moving pictures, and still pictures are divided into sections called “scenes”.

Track

Sections of a picture or a music piece on a CD, VIDEO CD or MP3. An album is composed of several tracks (MP3 only).

VIDEO CD

A compact disc that contains moving pictures. The picture data uses the MPEG 1 format, one of the worldwide standards for digital compression technology. The picture data is compressed to about 1/140 of its original size. Consequently, a 12 cm VIDEO CD can contain up to 74 minutes of moving pictures.

VIDEO CDs also contain compact audio data. Sounds outside the range of human hearing are compressed while the sounds we can hear are not compressed. VIDEO CDs can hold 6 times the audio information of conventional audio CDs.

There are 2 versions of VIDEO CDs.

- Ver. 1.1: You can play only moving pictures and sounds.
- Ver. 2.0: You can play high-resolution still pictures and enjoy PBC functions.

This system conforms to both versions.

Remote control

ALPHABETICAL ORDER

A - N

- ALBUM +/- **26** (10, 13)
- CD **32** (8, 9, 12, 13, 17, 20)
- CLEAR **9** (14)
- CLOCK/TIMER SELECT **2** (25, 26)
- CLOCK/TIMER SET **3** (8, 24, 25)
- DISPLAY **8** (26, 27, 32)
- D. SKIP **11** (10, 13)
- EFFECT ON/OFF **23** (21)
- ENTER **24** (8, 13, 16, 24, 25)
- GAME **6** (20, 22, 29)
- GROOVE **21** (21, 32)
- KARAOKE/MPX **17** (23)
- KEY CONTROL #/b **18** (23)
- NEXT **28** (11, 12, 15)
- Number buttons **29** (11, 12, 14)

O - Z

- ON SCREEN **12** (28)
- PLAY MODE **30** (10, 13, 19)
- PRESET EQ **25** (21, 23)
- PRESET +/- **28** (16, 18)
- PREV **28** (11, 12, 15)
- REPEAT/FM MODE **31** (13, 18)
- SELECT **13**
- SLEEP **1** (24)
- SPECIAL MENU **10** (14)
- SURROUND **19** (22)
- TAPE A/B **5** (19, 20, 23)
- TUNER/BAND **33** (16, 18, 20)
- TUNER MEMORY **7** (16)
- TUNING +/- **27** (16, 18)
- VOL +/- **20** (24)

BUTTON DESCRIPTIONS

- I/⏻ (power) **4** (7, 17, 24, 32)
- ◀/▶ (rewind/fast forward) **27** (10, 19, 33)
- ◀◀/▶▶ (go back/go forward) **28** (7, 10, 19)
- ▶ (play) **13** (10, 19, 23, 37)
- ⏸ (pause) **16** (7, 10, 19)
- (stop) **15** (10, 17, 19, 20, 23, 32)
- ↑/↓/←/→ (cursor) **22** (8, 24)
- RETURN ↻ **14** (12)

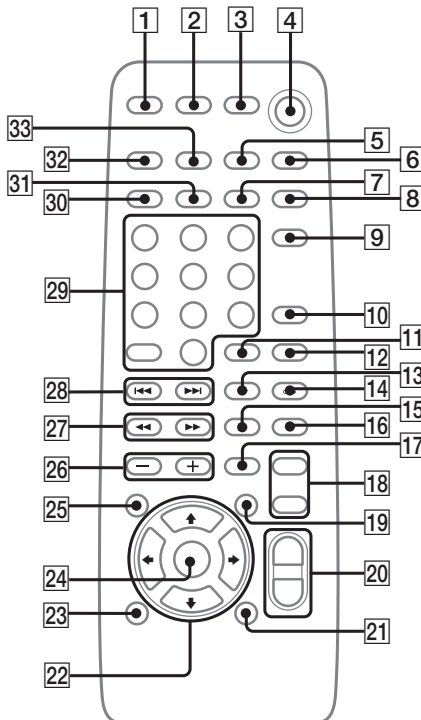

Additional Information

