

SONY[®]

4-248-439-12 (1)

Mini Hi-Fi Component System

Operating Instructions



Game SYNC
M I X I N G

MHC-GN88D
MHC-GN77D

© 2003 Sony Corporation

WARNING

To prevent fire or shock hazard, do not expose the unit to rain or moisture.

To prevent fire, do not cover the ventilation of the apparatus with newspapers, table-cloths, curtains, etc. And don't place lighted candles on the apparatus.

To prevent fire or shock hazard, do not place objects filled with liquids, such as vases, on the apparatus.

To avoid electrical shock, do not open the cabinet. Refer servicing to qualified personnel only.

Do not install the appliance in a confined space, such as a bookcase or built-in cabinet.

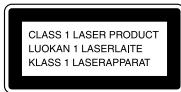

This appliance is classified as a CLASS 1 LASER product. The label is located on the rear exterior.



Don't throw away the battery with general house waste, dispose of it correctly as chemical waste.



ENERGY STAR® is a U.S. registered mark. As an ENERGY STAR® partner, Sony Corporation has determined that this product meets the ENERGY STAR® guidelines for energy efficiency.

The following caution label is located inside the apparatus.



This system incorporates Dolby® Digital, Dolby Pro Logic (II) adaptive matrix surround decoder, and the DTS® Digital Surround System.

* Manufactured under license from Dolby Laboratories.

“Dolby”, “Pro Logic”, and the double-D symbol are trademarks of Dolby Laboratories.

** Manufactured under license from Digital Theater Systems, Inc. “DTS” and “DTS Digital Surround” are registered trademarks of Digital Theater Systems, Inc.

US and foreign patents licensed from Dolby Laboratories.

About this manual

The instructions in this manual are for models MHC-GN88D and MHC-GN77D. In this manual, the MHC-GN88D is used for illustration purposes unless stated otherwise.

The MHC-GN88D consists of the following components:

- Tuner/DVD player/Stereo cassette deck/Amplifier (main unit) HCD-GN88D
- Speaker System
 - Front speakers SS-GN88D
 - Surround speakers SS-RS88D
 - Center speaker SS-CT88

The MHC-GN77D consists of the following components:

- Tuner/DVD player/Stereo cassette deck/Amplifier (main unit) HCD-GN77D
- Speaker System
 - Front speakers SS-GN88D
 - Surround speakers/center speaker SS-RS77D

Table of Contents

How to use this manual	5
Playable discs	5

List of Button Location and Reference Pages

Main unit	8
Remote Control	9

Getting Started

Hooking up the system	10
Positioning the speakers	13
Setting the clock	14
Selecting a language	14

DVD/VIDEO CD/CD/MP3/JPEG

— Play	
Loading a disc	15
Playing a disc	
— Normal Play/Shuffle Play	15
Playing DVDs using the menu	18
Playing VIDEO CDs with PBC functions (Version 2.0)	
— PBC Play	19
Playing JPEG Image Files	19
Playing repeatedly	
— Repeat Play	20
Creating your own program	
— Program Play	22
Searching for a title/chapter/track/index/album/file	24

DVD – Various functions

Changing the sound/subtitle/ language	26
Adjusting the angle/image	29
Restricting disc playback	
— CUSTOM PARENTAL CONTROL/ PARENTAL CONTROL	32
Speaker settings	
— SPEAKER SETUP	36
List of items that can be displayed and selected by disc type	39
System setup item list	40

Tuner

Presetting radio stations	41
Listening to the radio	
— Preset Tuning	42
— Manual Tuning	42

Tape

Loading a tape	43
Playing a tape	43
Recording to a tape	
— CD Synchro Recording/ Recording Manually/ Program Edit	44
Timer recording radio programs	45

Sound Adjustment

Adjusting the sound	47
Selecting the preset effect	47
Selecting the sound field	48
Adjusting the graphic equalizer and storing the personal file	49

continued

Table of Contents (continued)

Display

Turning off the display	
— Power Saving Mode	50
Changing the spectrum analyzer display	50
Adjusting the brightness of the display	50
Changing the power illuminator	51
Viewing information about the disc in the display	51
Viewing information about the disc in the on-screen display	53
Checking the date information (JPEG image files only)	54

Other Features

Enhancing the video game sound	
— Game Sync	55
Mixing video game sound with other sound source	
— Game Mixing	55
Singing along: Karaoke	55
Mixing and recording sounds	56
Falling asleep to music	
— Sleep Timer	57
Waking up to music	
— Daily Timer	57

Optional Components

Hooking up optional components	59
Listening to audio from a connected component	60
Recording on a connected component	61
Connecting external antennas	61

Troubleshooting





Problems and remedies	62
Messages	67

Additional Information

Precautions	68
Specifications	70
Glossary	73
Language code list	back page

How to use this manual











- This manual mainly explains operations using the buttons on the system, but the same operations can also be performed using the buttons on the remote having the same or similar names.
- The following symbols are used in this manual.

Symbol	Meaning
	Functions that can be used with DVDs
	Functions that can be used with VIDEO CDs
	Functions that can be used with audio CDs
	Functions that can be used with MP3 audio tracks
	Functions that can be used with JPEG image files

Playable discs

You can play back the following discs on this system. Other discs cannot be played back.

List of playable discs

Format of discs	Disc logo	Contents
DVD VIDEOS		Audio + Video
VIDEO CDs		Audio + Video
Audio CDs		Audio
CD-R/CD-RW (Audio CDs)	 	Audio
CD-R/CD-RW (Discs with MP3 audio tracks)	   	Audio
CD-R/CD-RW (Discs with JPEG image files)	 	Picture

The “DVD VIDEO” logo is a trademark.

Region code of DVDs you can play on this system

Your system has a region code printed on the back of the system and will only play DVDs labeled with identical region code.

DVDs labeled  will also be played on this system.

If you try to play any other DVD, the message “Playback prohibited by area limitations.” will appear on the TV screen. Depending on the DVD, no region code indication may be labeled even though playing the DVD is prohibited by area restrictions.

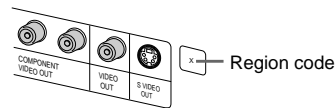

5GB

Discs that this system cannot play

- CD-ROMs (except for extension “.MP3”, “.JPG”, or “.JPEG”).
- CD-Rs/CD-RWs other than those recorded in the following formats:
 - audio CD format.
 - VIDEO CD format.
 - MP3 audio track or JPEG image file format that conforms to ISO9660*¹ Level 1, Level 2, Joliet in expansion format or Multi Session*².
- Data part of CD-Extras*³.
- Super Audio CDs or Super Video CDs.
- Progressive JPEG format files.
- DVD-RWs in VR mode (DVD-RWs created in VR (Video Recording) mode) allow the contents to be programmed or edited.
- DVD-ROMs.
- DVD audio discs.
- A DVD with a different region code.
- MP3 audio tracks other than MPEG 1 Audio Layer 3 format.
- A disc that has a non-standard shape (e.g., card, heart).
- A disc with paper or stickers on it.
- A disc that has the adhesive, cellophane tape, or a sticker still left on it.

*¹ISO9660 Format

The most common international standard for the logical format of files and folders on a CD-ROM. There are several specification levels. In Level 1, file names must be in the 8.3 format (no more than eight characters in the name, no more than three characters in the extension “.MP3” or “.JPG”) and in capital letters. Folder names can be no longer than eight characters. There can be no more than eight nested folder levels. Level 2 specifications allow file names and folder names up to 31 characters long. Each folder can have up to 8 trees. For Joliet in the expansion format, file and folder names can have up to 64 characters.

*²Multi Session

This is a recording method that enables adding of data using the Track-At-Once method. Conventional CDs begin at a CD control area called the Lead-in and end at an area called Lead-out. A Multi Session CD is a CD having multiple sessions, with each segment from Lead-in to Lead-out regarded as a single session.

*³CD-Extra

This format records audio (audio CD data) on the tracks in session 1 and data on the tracks in session 2.

Notes on discs

- This system can play CD-R/CD-RW discs edited by the user. However, note that playback of some discs may not be possible depending on the recording device used for recording or the disc condition.
- Disc recorded on CD-R/CD-RW drives may not be played back because of scratches, dirt, recording condition or the driver’s characteristics.
- CD-R and CD-RW discs that have not been finalized (processing to allow play by a normal CD player) cannot be played back.
- CD-R and CD-RW discs recorded in multi-session that have not ended by “closing the session” are not supported.
- The system may be unable to play MP3 or JPEG format files that do not have the extension “.MP3”, “.JPEG” or “.JPG”.
- Attempting to play non-MP3 or non extension JPEG format files that have the extension “.MP3”, “.JPG” or “.JPEG” may result in noise or malfunction. Playback is possible up to 8 levels.
- With format other than ISO9660 level 1, level 2 or Joliet in expansion format folder titles or file titles may not be displayed correctly.
- The following discs take a longer time to start playback
 - a disc recorded with complicated tree structure.
 - a disc recorded in Multi Session.
 - a disc to which data can be added (non-finalized disc).
- Some CD-Rs, CD-RWs, DVD-Rs or DVD-RWs (in video mode) (DVD-RWs created in video mode have the same format as a DVD VIDEO) cannot be played on this system depending upon the recording quality or physical condition of the disc, or the characteristics of the recording device. Furthermore, the disc will not play if it has not been correctly finalized. For more information, see the operation instructions for the recording device.
- A disc recorded in packet write format cannot be played back.

Note on playback operations of DVDs and VIDEO CDs

Some playback operations of DVDs and VIDEO CDs may be intentionally set by software producers. Since this system plays DVDs and VIDEO CDs according to the disc contents the software producers designed, some playback features may not be available. Also, refer to the instructions supplied with the DVDs or VIDEO CDs.

Music discs encoded with copyright protection technologies

This product is designed to playback discs that conform to the Compact Disc (CD) standard. Recently, various music discs encoded with copyright protection technologies are marketed by some record companies. Please be aware that among those discs, there are some that do not conform to the CD standard and may not be playable by this product.

Cautions when playing a disc that is recorded in Multi Session

- This system can play Multi Session CDs when an MP3 audio track is contained in the first session. Any subsequent MP3 audio tracks recorded in later sessions can also be played back.
- This system can play Multi Session CDs when a JPEG image file is contained in the first session. Any subsequent JPEG image files session recorded in later sessions can also be played back.
- If audio tracks and images in audio CD format or VIDEO CD format are recorded in the first session, only the first session will be played back.
- When you play Multi Session discs with different formats mixed in each session, the format of the first session is recognized as the disc type. Tracks in the second and subsequent sessions are played if they are the same formats as the first session, but different format tracks are not played. However, in the case of audio CD, even if audio CD tracks are present in the second and subsequent sessions, only the audio CD tracks in the first sessions are played.

List of Button Location and Reference Pages

How to use page 8–9

Use page 8–9 to find the location of buttons and other parts of the system that are mentioned in the text.

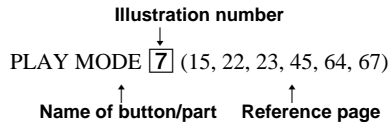

Main unit

ALPHABETICAL ORDER

A - D

ALBUM +/- **15** (16, 22, 45)
 AMP MENU **46** (42, 49, 50, 66)
 CD SYNC **18** (44, 45)
 DECK A **30** (43)
 DECK B **24** (43, 44–46, 56)
 DIRECTION **9** (43–45, 56)
 DISC 1–3 **3** (16, 17, 22, 45)
 DISC SKIP EX-CHANGE **4**
 (15, 16, 22, 45)
 Disc tray **6** (15)
 DISPLAY **44** (50–52)
 Display **2**
 DVD **43** (13–17, 22, 42, 44, 45, 65)
 DVD MENU **17** (18, 31, 65)
 DVD TOP MENU **9** (18)

E - G

ECHO LEVEL **26** (56)
 EFFECT ON/OFF **47** (47)
 FM MODE **8** (42, 66)
 GAME **39** (55, 59, 60)
 GAME EQ **33** (47)
 GAME INPUT (jacks) **29** (44, 55)
 GAME MIXING **37** (44, 55)
 GROOVE **35** (47)

H - M

ILLUMINATION **31** (51)
 IR (receptor) **45**
 KARAOKE/MPX **36** (55, 56)
 MD (VIDEO) **40** (60)
 MIC (jack) **28** (55, 56)
 MIC LEVEL **27** (55, 56)
 MOVIE EQ **16** (47)
 MULTI CHANNEL DECODING
 (indicator) **48**
 MUSIC EQ **38** (47)

O - R

OPEN/CLOSE **5** (15, 16, 63)
 P FILE **22** (49)
 PHONES (jack) **25** (62)
 PLAY MODE **7** (15, 22, 23, 45,
 64, 67)
 Power illuminator **32** (51)
 PUSH ENTER **10** (14, 16, 18, 19,
 22, 41, 45, 46, 49, 50, 57, 58, 67)
 REC PAUSE/START **19** (44, 45,
 55, 56)
 REPEAT **8** (20, 21)

S - Z

SOUND FIELD **21** (48, 63)
 TAPE A/B **41** (43, 44, 56)
 TUNER/BAND **42** (41, 42)
 TUNER MEMORY **7** (41)
 VOLUME **23** (51, 62)

SYMBOLS

I/⏻ (power) **1**
 ◀▶ (play) **11**
 ■ (stop) **12**
 || (pause) **13**
 ◀◀ (go backward) **14**
 ▶▶ + (go forward) **14**
 ◀◀ (rewind) **15**
 ▶▶ (fast forward) **15**
 ⏮/⏪/⏩/⏭ **10**
 ⏮ A (Deck A) **34**
 ⏮ B (Deck B) **20**

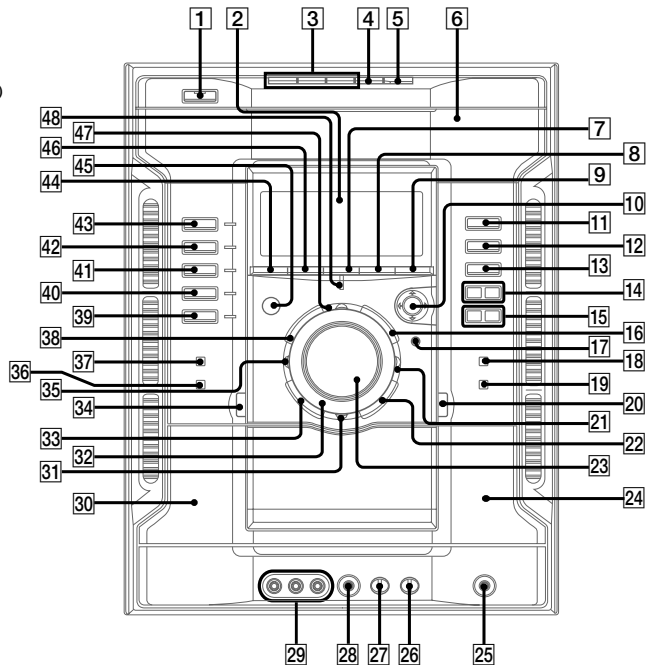

Remote Control

ALPHABETICAL ORDER

A - D

- ALBUM +/- **35** (16, 18, 20, 22, 45)
- AMP MENU **43** (49, 50)
- ANGLE **23** (30)
- AUDIO **24** (26)
- CLEAR **13** (21, 23, 25, 45)
- CLOCK/TIMER SELECT **2** (46, 58, 67)
- CLOCK/TIMER SET **3** (14, 45, 57, 62)
- D.SKIP **11** (15, 16, 22, 45)
- DISPLAY **44** (50-53)
- DVD **48** (14-17, 22, 42, 44, 45)
- DVD DISPLAY **42** (16, 18-22, 24-27, 29, 30, 32, 39, 53, 54)
- DVD MENU **33** (18, 28, 31)
- DVD SETUP **40** (14, 18, 27, 30, 33, 34, 36, 37, 40, 67)
- DVD TOP MENU **34** (18)

E - N

- EFFECT ON/OFF **21** (47)
- ENTER **31** (14, 16, 18-30, 32-37, 41, 45, 46, 49, 50, 53, 54, 57, 58, 67)
- GAME **47** (55, 59, 60)
- GAME EQ **30** (47)
- GAME MIXING **46** (44, 55)
- GROOVE **19** (47)
- KEY CONTROL #/b **27** (56)
- MD (VIDEO) **45** (60)
- MUSIC EQ **32** (47)
- MOVIE EQ **25** (47)
- NEXT **37** (16)
- Numeric button **10** (18, 19, 23, 25, 28, 32-35)

O - S

- P FILE **28** (49)
- PLAY MODE **14** (15, 22, 23, 45, 64, 67)
- PRESET + **37** (41, 42)
- PRESET - **38** (41, 42)
- PREV **38** (16)
- REPEAT **12** (20, 21)
- RETURN **39** (19, 20, 24, 25, 32, 34)
- SELECT **15** (19)
- SOUND FIELD **20** (48, 63)
- SUBTITLE **22** (27)
- SLOW **17** (16)
- SLEEP **1** (57)

T - Z

- TAPE A/B **6** (43)
- TUNER BAND **49** (41, 42)
- TUNING +/- **36** (41, 42)
- TV CH +/- **8** (12)
- TV VOL +/- **7** (12)
- TV/VIDEO **9** (12)
- TV I/⏻ **4** (12)
- VOL +/- **26** (51)

SYMBOLS

- I/⏻ (power) **5**
- (stop) **18**
- || (pause) **16**
- ◀▶ (play) **15**
- ▶▶ (go backward) **37**
- ◀◀ (go forward) **38**
- ▶▶/◀◀ (fast forward/rewind) **36**
- ↑/↓/←/→ **29**
- >10 **41**

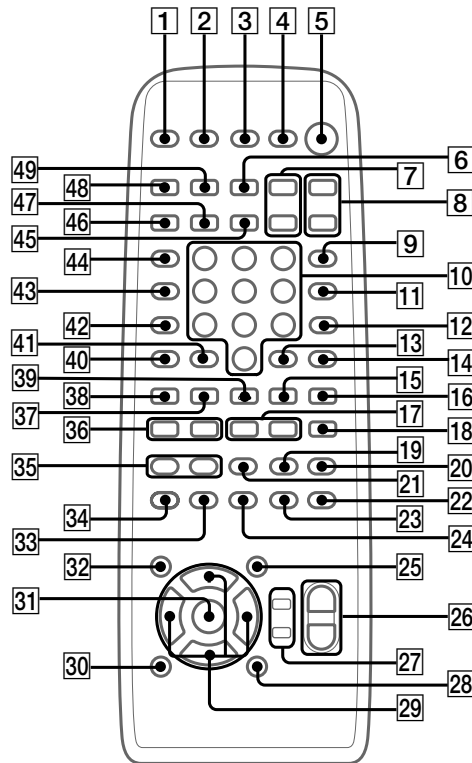

Getting Started

Hooking up the system

Do the following procedures **1** to **7** to hook up your system using the supplied cords and accessories.

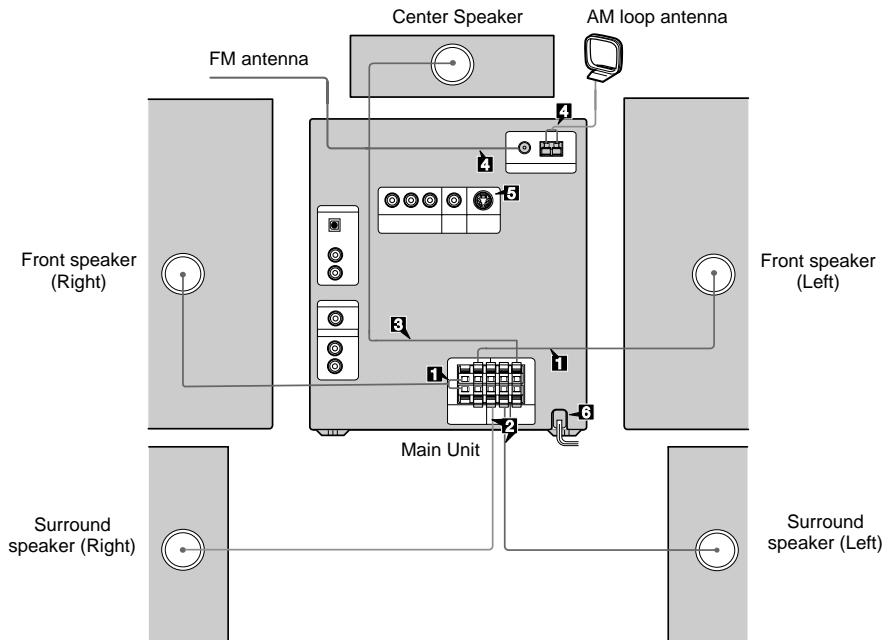

1 Connect the front speakers.

Connect the speaker cords to the FRONT SPEAKER terminals.

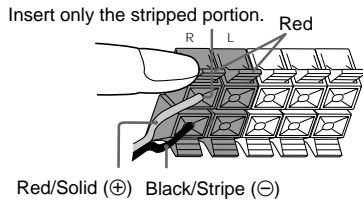

2 Connect the surround speakers

Connect the speaker cords to SURROUND SPEAKER terminals.

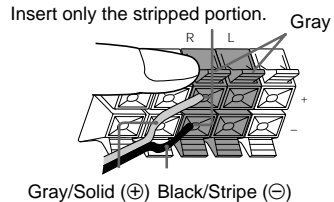

3 Connect the center speaker.

Connect the speaker cords to the CENTER SPEAKER terminals.

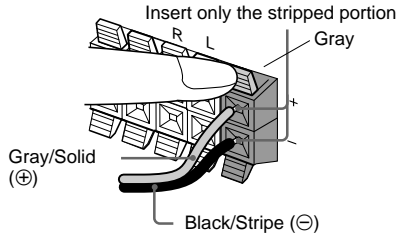

4 Connect the FM and AM antennas.

Set up the AM loop antenna, then connect it.

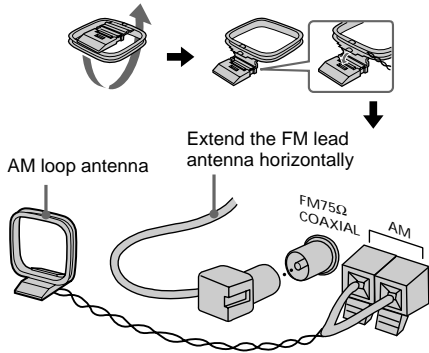

5 Connect the video input jack of your TV to the VIDEO OUT jack with the supplied video cable.

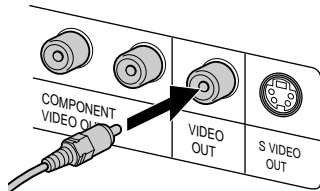

When using a TV
Turn on the TV and select the video input so that you can view the pictures from this system.

When connecting a video deck
Connect the video deck to the TV using an audio/video cord (not supplied). However, do not connect this system to the TV through the video deck. Otherwise, you may experience video leakage when watching video from this system. Connect this system directly to the TV as shown below.

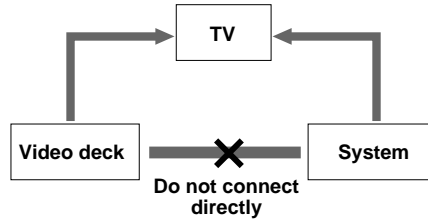

Tip

For even higher quality video images:

- Use an optional component video cables to connect the COMPONENT VIDEO input jacks on your TV to the COMPONENT VIDEO OUT jacks of this system. If your TV is compatible with progressive format file signals, use this connection and set "COMPONENT OUT" to "PROGRESSIVE" in "Adjusting the TV screen" (page 30).
- You can use an optional S Video cord to connect the S VIDEO input jack on your TV to the S VIDEO OUT jack of this system.

continued

Hooking up the system (continued)

6 Connect the power cord to a wall outlet.

The demonstration appears in the display. When you press I/⏻, the system turns on and the demonstration automatically ends.

7 Set the color system to PAL or NTSC depending on the color system of your TV.

The color system is factory set to NTSC for region code 3 models, and PAL for other region code models. Each time you perform the procedure below, the color system changes as follows:

NTSC ↔ PAL

Use the buttons on the system.

1 Press I/⏻ to turn off the system.

2 Press I/⏻ while holding down ■.

The system turns on and the color system is changed.

Notes

- Keep the speaker cords away from the antennas to prevent noise.
- The type of speakers supplied vary according to the model you purchased (see “Specifications” on page 70).
- Be sure to connect both left and right surround speakers. Otherwise, the sound will not be heard.
- You cannot set the color system in the Power Saving Mode (see “Turning off the display” on page 50).
- When you playback a VIDEO CD recorded in a different color system from the one you set to the system, the picture image may be distorted.

To connect optional components

See page 59.

Inserting two R6 (size AA) batteries into the remote

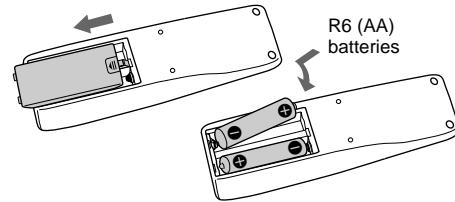

Operating a Sony TV

You can use the following buttons on the remote to operate a Sony TV.

To	Press
Turn the TV on or off	TV I/⏻
Switch the TV's input source between the TV and other input sources	TV/VIDEO
Change the TV channels	TV CH +/-
Adjust the volume of the TV speaker(s)	TV VOL +/-

Note

If you do not use the remote for a long period of time, remove the batteries to avoid possible damage from battery leakage and corrosion.

Tip

With normal use, the batteries should last for about six months. When the remote no longer operates the system, replace both batteries with new ones.

Attaching the speaker pads

Attach the supplied speaker pads to the bottom of the speakers to stabilize the speakers and to prevent them from slipping.

Front speaker (Left (4)/Right (4))

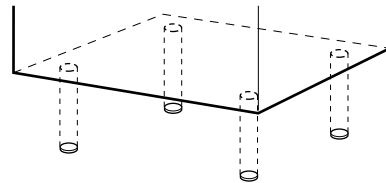

Center/surround speaker (4)

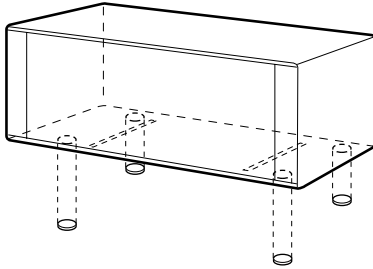

Notice for carrying this system

Do the following to protect the DVD mechanism. Use the buttons on the system.

- 1 Make sure that all discs are removed from the system.
- 2 Hold down DVD and then press I/⏻ until "LOCK" appears in the display.
- 3 Release I/⏻ first, then release DVD.
- 4 Unplug the AC power cord.

Positioning the speakers

- 1 Place the front speakers at an angle of 45 degrees from your listening position.

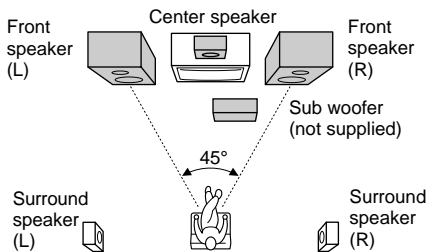

- 2 Place the center speaker at about the same height as the front speakers.

Align the center speaker with the front speakers or place it slightly behind the front speakers.

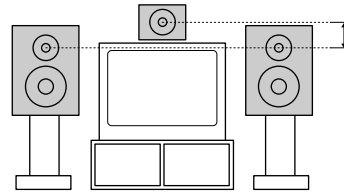

- 3 Place the surround speakers facing each other at about 60 to 90 cm above your listening position.

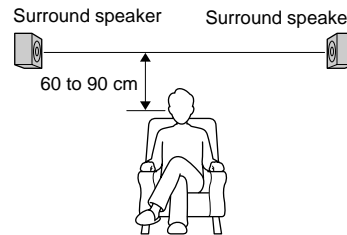

Tip

You can enjoy 5.1 channel surround sound while playing a DVD. To adjust the speaker volume and level, see page 37.

Notes

- If you place the center speaker on the system, be sure to place it at the front side of the system.
- Always place the sub woofer vertically, keeping it a few centimeters away from the wall.
- If the sub woofer is placed in the center of a room, the bass could be extremely weakened. This is due to the influence of the standing wave of the room. If this happens, move the sub woofer away from the center of the room or eliminate the cause of the standing wave, by placing a bookshelf against the wall, etc.

Setting the clock

- 1 Press I/⏻ to turn on the system.
- 2 Press CLOCK/TIMER SET on the remote.
- 3 Press ↑ or ↓ repeatedly to set the hour.
- 4 Press PUSH ENTER (or ENTER on the remote).
- 5 Press ↑ or ↓ repeatedly to set the minute.
- 6 Press PUSH ENTER (or ENTER on the remote).
The clock starts functioning.

To adjust the clock

- 1 Press CLOCK/TIMER SET on the remote.
- 2 Press ↑ or ↓ repeatedly to select "CLOCK SET?" and then press PUSH ENTER (or ENTER on the remote).
- 3 Do the same procedure as steps 3 to 6 above.

Note

The clock settings are canceled when you disconnect the power cord or if a power failure occurs.

Selecting a language

You can change the on-screen display language.

- 1 Turn on your TV and select the video input.
- 2 Press I/⏻ to turn on the system.
- 3 Press DVD to switch the function to DVD.
- 4 Press DVD SETUP on the remote in stop mode.
The Setup Menu appears on the on-screen display.
- 5 Press ↑ or ↓ repeatedly to select "LANGUAGE SETUP", then press PUSH ENTER (or ENTER on the remote).
- 6 Press ↑ or ↓ repeatedly to select "OSD", then press PUSH ENTER (or ENTER on the remote).
- 7 Press ↑ or ↓ repeatedly to select a language from the displayed list, then press PUSH ENTER (or ENTER on the remote).

DVD/VIDEO CD/CD/MP3/JPEG

—Play

Loading a disc

- 1 Press **OPEN/CLOSE** \blacktriangle .
The disc tray slides out.
- 2 Place a disc with the label side facing up on the disc tray.

When you play a CD single, place it on the inner circle of the tray

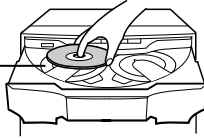

To insert additional discs, press **DISC SKIP EX-CHANGE** to rotate the disc tray.

- 3 Press **OPEN/CLOSE** \blacktriangle to close the disc tray.

Note

Do not push the disc tray when closing it as this may cause malfunction. Press **OPEN/CLOSE** \blacktriangle to close the disc tray.

Playing a disc

—Normal Play/Shuffle Play



You can play up to three discs (DVD, VIDEO CD, audio CD or MP3 audio tracks) in a row. Before playing a DVD or a VIDEO CD, turn on your TV and select the video input. Depending on the DVD or VIDEO CD, some operations may be different or restricted. Refer to the operating instructions supplied with the disc.

When playing a DVD:

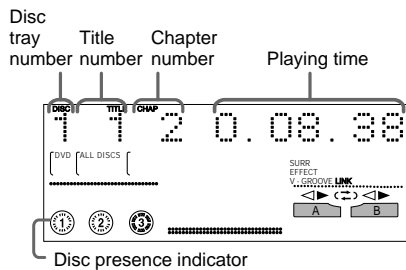

When playing a VIDEO CD:

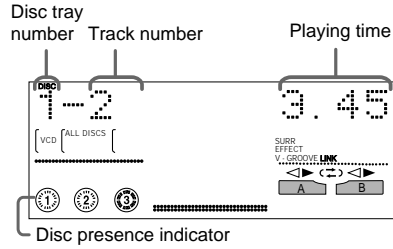

When playing an audio CD:

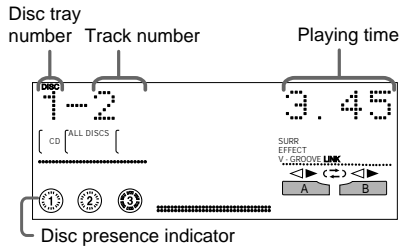

When playing an MP3 audio tracks:

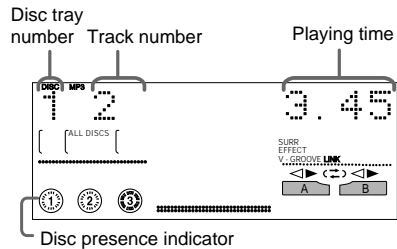

- 1 Press **DVD**.
- 2 When playback is stopped, press **PLAY MODE** repeatedly until the play mode you want lights up in the display.

continued

Playing a disc (continued)

Select	To play
ALL DISCS (Normal Play)	All discs in the disc tray continuously.
1 DISC (Normal Play)	The track on the disc you have selected in the original order.
ALBM (Normal Play)	All MP3 audio tracks in the album on the disc you have selected in original order. When playing a non-MP3 disc, "ALBM" play performs the same operation as "1 DISC" play.
ALL DISCS SHUF (Shuffle Play)*	The tracks on all discs in random order.
1 DISC SHUF (Shuffle Play)*	The tracks on the disc you have selected in random order.
ALBM SHUF (Shuffle Play)*	The MP3 audio tracks in the album on the disc you have selected in random order. When playing a non-MP3 disc, "ALBM SHUF" play performs the same operation as "1 DISC SHUF" play.
PGM (Program Play)*	The tracks on all discs in the order you want them to be played back (see "Creating your own program" on page 22).

* You cannot perform Shuffle Play and Program Play while playing DVD.

3 Press <◁▷> .

Tip

You can change the play mode between 1 DISC, ALL DISCS and ALBM using the on-screen display as follows:

- 1 Press DVD DISPLAY on the remote in stop mode.
The control menu appears.
- 2 Press ↑ or ↓ to select "PLAY MODE", then press PUSH ENTER (or ENTER on the remote).
- 3 Press ↑ or ↓ to select the play mode you want, then press PUSH ENTER (or ENTER on the remote).

Other Operations

To	Do this
Stop playback	Press ■. The playback stops at the point ■ is pressed (Resume Play). Press ■ again to cancel the Resume Play (see page 18).
Pause playback	Press ■ ¹⁾ . Press ■ again to resume playback.
Select a track or chapter	Press ◀◀ or ▶▶ (or PREV or NEXT on the remote) repeatedly during play or pause.
Select an album of MP3 audio tracks	Press ALBUM +/-.
Locate a point quickly in fast forward or fast reverse ²⁾ (Lock Search)	Press ▶▶ or ◀◀ during playback. For DVD or VIDEO CD, each time you press the button, searching speed changes as follows: 1 (slow) ↔ 2 (high) For audio CD, searching speed does not change. Press ◀▷ at the point you want to resume playback.
Watch frame by frame (Slow motion play) ¹⁾³⁾	During playback, press SLOW ◀◀ or SLOW ▶▶. Each time you press the button, the playback speed change as follows: Playback direction SLOW 1 ▶▶ ⁴⁾ ↔ SLOW 2 ▶▶ ⁴⁾ . Opposite direction SLOW 1 ◀◀ ⁴⁾ ↔ SLOW 2 ◀◀ ⁴⁾ . Press ◀▷ at the point you want to resume playback.
Select a disc when playback is stopped	Press one of the DISC 1~3 buttons or DISC SKIP EX-CHANGE (or D.SKIP on the remote).
Switch to DVD function from another source	Press DVD or one of the DISC 1~3 buttons (Automatic Source Selection).
Exchange other discs while playing	Press DISC SKIP EX-CHANGE.
Remove the disc	Press OPEN/CLOSE ▲.

- 1) There may be some disturbance in the video image.
- 2) Except for MP3 audio tracks.
- 3) DVD and VIDEO CD only.
- 4) SLOW 2 /SLOW 2 playback speed is slower than SLOW 1 /SLOW 1 . Slow-motion reverse play is for DVD only.

Notes

- If DVD playback is paused for approximately one hour, the systems automatically turns off.
- Depending on the DVD or VIDEO CD, some operations may be restricted.
- When you use headphones only 2 channel sound is heard.
- During lock search or slow motion play, no sound is output.
- You cannot change the play mode during playback.
- The system may take some times to start playback of the discs which is recorded in complex configurations such as many layers.
- The system can playback MP3 (MPEG 1 Audio Layer 3) audio tracks. The system cannot playback MP3 audio tracks in format other than MPEG 1 Audio Layer 3 format.
- This system can play Multi Session discs when an MP3 audio track is located in the first session. Any subsequent MP3 audio tracks, recorded in the later sessions, can also be played back.
- When naming, be sure to add the file extension “.MP3” to the title name.
- If you save up the extension “.MP3” to a track other than MP3 audio tracks, the system cannot recognize the track properly and will generate random noise that could damage your speakers.
- You are recommended not to save other type of tracks or unnecessary album on a disc that has MP3 audio tracks.
- The disc recorded with complicated tree structure takes a longer time to start playback.

- When the disc is inserted, the system reads all the tracks in that disc. If there are many albums or non MP3 audio tracks on the disc, it may take a longer time for playback to begin or for the next MP3 audio track to start playback.
- An album that does not include an MP3 audio track is skipped.
- The maximum number of albums on a disc which can be recognize by this system is 99.
- The maximum number of MP3 audio tracks on an album which can be recognize by this system is 250.
- Playback follows the recorded order of albums and tracks on the disc.
- Depending on the encoding/writing software, recording device, or the recording media used at the time an MP3 audio track is recorded, you may encounter problems such as cannot playback, sound interruptions, and noise.
- When the system cannot play MP3 audio track, remove the disc and select “CUSTOM SETUP” from the setup items. Then select “DATA CD PRIORITY” and set to “MP3” (page 29) and insert the disc again.
- The system can play to a depth of 8 directories.

Tips

- When you press DVD or one of the DISC 1~3 buttons to switch to DVD function from tuner, you may require a longer time to access the disc. Set “DVD POWER ON” by DVD power manage function (page 42).
- If you press DVD while the power is off, the power turns on and DVD is selected as a function.

continued

Playing a disc (continued)

Resuming playback from the point you stopped the disc

— Resume Play

This system memorizes the point where you stopped the disc so you can resume from that point. Resume Play is not canceled when you turn off the system.

- 1 While playing a disc, press ■ to stop playback.**
“RESUME” appears in the display. If “RESUME” does not appear, Resume Play is not available.
- 2 Press <◀▶.**
The system starts playback from the point you stopped the disc in step 1.

Notes

- You cannot perform Resume Play during Shuffle Play or Program Play.
- Depending on where you stopped the disc, the system may resume playback from a different point.
- Resume play is canceled when:
 - you press ■ when playback is stop.
 - you disconnect the AC power cord.
 - you open the disc tray.
 - you change the play mode.
 - you change the settings using the DVD DISPLAY or DVD SETUP button.

Playing a track by entering the track number (on the remote only)

Press the numeric button(s) to enter the track number of the track you want to play. (To enter the MP3 audio track number, press ALBUM + or – repeatedly to select the desired album before entering the number.)

To enter a track number over 10

- 1 Enter the corresponding digits.**
To enter 0, press 10/0.
- 2 Press ENTER.**
Example:
To play track number 30, press 3 and 10/0, then press ENTER.
To play MP3 audio track number 100, press 1, 10/0 and 10/0, then press ENTER.

Playing DVDs using the menu

DVD

Some DVDs have menus to help you enjoy the DVDs. You can play DVDs using these menus on TV screen.

Using the DVD top menu

A DVD is divided into long sections of a picture or a music feature called “title”. When you play a DVD which contains several titles, you can select the title you want using the menu.

Using the DVD menu

Some DVDs allow you to select the disc contents using a menu. When you play these DVDs, you can select items such as the language for the subtitles and the language for the sound using the DVD menu.

- 1 Press DVD TOP MENU or DVD MENU.**
The menu appears on the TV screen. The contents of the menu vary from disc to disc.
- 2 Press ↑ and ↓ or ← and → (or the numeric buttons on the remote) to select the title or item you want to play.**
- 3 Press PUSH ENTER (or ENTER on the remote).**

Note



If the DVD top menu or a DVD menu is displayed during DVD playback for approximately one hour, the system automatically turns off.

Playing VIDEO CDs with PBC functions (Version 2.0)



— PBC Play

You can use PBC* menus on your TV screen to enjoy the disc's interactive software. The menu format and structure may differ depending on each disc.

*PBC: Playback Control

1 Press   to start playing a VIDEO CD with PBC functions (Version 2.0).

The PBC menu appears on the TV screen.

2 Press  or  (or the numeric buttons on the remote) to select the item number you want.

3 Press PUSH ENTER (or ENTER on the remote).

4 Continue playback according to the instructions on the menus to enjoy interactive playback.

Refer to the operating instructions supplied with the disc, as the operation procedure may differ according to the VIDEO CD.



To go back to the previous menu
Press RETURN  on the remote.



Note

Depending on the VIDEO CD, "Press ENTER" in step 3 may appear as "Press SELECT" in the operating instructions supplied with the disc. In this case, press SELECT on the remote.



Tip

You can cancel playback with PBC functions.

1 In stop mode, press  or  (or the numeric buttons on the remote) to select a track.

2 Press  .

"Play without PBC" appears on the TV screen and playback starts from the selected track. Still images, such as the menu screens, will not be shown.

To return to PBC playback, press  twice, then press  .

Playing JPEG Image Files

You can play JPEG image files on CD-ROMs, CD-Rs, or CD-RWs. However, the discs must be recorded according to ISO9660 level 1, level 2 or Joliet format for the system to recognize the files. You can also play discs recorded in Multi Session. See the instructions of the CD-R/RW device or recording software (not supplied) for details on the recording format.

1 Load a disc with JPEG image files into the system.

2 Press .

The system starts to play the first JPEG image file in the first album on the disc.

Notes

- The system can play JPEG image files with the extension ".JPG" or ".JPEG".
- Progressive JPEG image files cannot be played on this system.
- Some CD-Rs or CD-RWs cannot be played on this system depending on file format.
- The maximum number of albums on a disc which can be recognize by this system is 99.
- The maximum number of JPEG image file on an album can be recognize by this system is 250.
- The system can play to a depth of 8 directories.

Selecting an album and file

Use buttons on the remote for the operation.

1 Press DVD DISPLAY.

The Control Menu and disc title of JPEG data disc appears.

2 Press  or  to select "ALBUM", then press ENTER.

The list of albums contained in the disc appears.

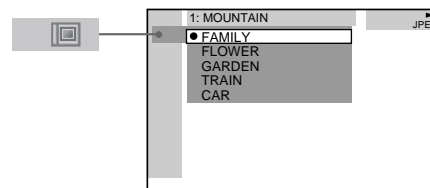

continued

Playing JPEG Image Files (continued)

3 Select an album you want to play using **↑** or **↓** and press **ENTER**.

4 Select "FILE" using **↑** or **↓** and press **ENTER**.

The list of files contained in the current album appears.

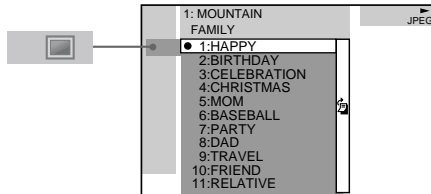

When the list of all files or albums cannot be displayed on the window, the jump bar appears. Press **→** to select the jump bar icon, and then scroll the jump bar to display the rest of the list using **↑** or **↓**.

5 Select a file using **↑** or **↓** and press **ENTER**.

The selected file starts playing.

To return to the previous display

Press **←** or **RETURN** ↵.

To turn off the display

Press **DVD DISPLAY**.

Note

Only the letters in the alphabet and numbers can be used for album or file names. Anything else is displayed as blank space.

Tip

When a JPEG data disc is inserted, you can select an album using **ALBUM + or -**.

Enjoying the slide show

1 Press **▶▶** while displaying a JPEG image file.

Slide show starts from the current image.

2 Press **◀▶** when you want to return to normal play.

To change the interval time of slide show

Each time you press **▶▶** during slide show, the speed time changes cyclically as follows:

FF1 **▶▶** (slow) →

FF2 **▶▶** (normal) →

FF3 **▶▶** (high) →

The FF3 **▶▶** is faster than FF2 **▶▶** and FF2 **▶▶** is faster than FF1 **▶▶**.

To rotate the current image

Rotate the current image using **← or **→**.**

Each time you press **→**, the image turns clockwise by 90°.

Each time you press **←**, the image turns counterclockwise by 90°.

Notes

- Slide show can play in only one direction.
- You cannot rotate the image during slide show. Press **<|>** to return to normal play before this operation.

Playing repeatedly

— Repeat Play



You can play all the titles/tracks/files or a single title/chapter/track on a disc repeatedly.

Using the front panel display

Press **REPEAT** during playback until "**REP**" or "**REP1**" appears.

REP: All the tracks on the disc, or all the tracks in the album* are played back repeatedly up to five times.

REP1: A single title/chapter/track is played back repeatedly until "**REP 1**" is cancelled.

* When "**ALBM**" is selected for MP3 audio tracks and JPEG image files or "**ALBM SHUF**" is selected for MP3 audio tracks.

To cancel Repeat Play
Press REPEAT repeatedly until both “REP”
and “REP1” disappear.

Using the on-screen display

Use buttons on the remote for this operation.

1 Press DVD DISPLAY during playback.

The Control Menu appears.

2 Press \uparrow or \downarrow repeatedly to select “REPEAT”, then press ENTER.

If you do not select “OFF”, the “REPEAT”

 indicator lights up in green.

The options for “REPEAT” appear.

3 Press \uparrow or \downarrow repeatedly to select the Repeat Play setting.

The default setting are underlined.

■ When playing a DVD

- OFF: does not play repeatedly.
- ALL¹⁾: repeats all the titles on the current disc.
- TITLE: repeats the current title.
- CHAPTER: repeats the current chapter.

■ When playing a VIDEO CD/audio CD or MP3 audio tracks in play mode other than “PGM”.

- OFF: does not play repeatedly.
- ALL: repeats all the tracks on the current disc, or all the tracks in the current album²⁾.
- TRACK: repeats the current track.

■ When playing a JPEG image file

- OFF: does not play repeatedly.
- ALL: repeats all the files on the current disc, or repeats all the files in the current album²⁾.

■ When playing a VIDEO CD, audio CD or MP3 audio tracks in “PGM” mode.

- OFF: does not play repeatedly.
- ALL: repeats Program Play.

4 Press ENTER.

Repeat Play starts.

¹⁾ When “SHUFFLE(ALL)” is selected, you cannot set Repeat Play to “ALL”.

²⁾ When “CONTINUE(ALBUM)” is selected for MP3 audio tracks and JPEG image files or “SHUFFLE (ALBUM)” is selected for MP3 audio tracks.

To cancel Repeat Play

Select “OFF” in step 3, or press CLEAR.

To turn off the Control Menu

Press DVD DISPLAY repeatedly until the Control Menu disappears.

Notes

- Depending on the DVD, you cannot perform Repeat Play.
- You cannot perform Repeat Play during PBC playback of VIDEO CDs (page 19).
- You cannot select “REP1” during Program Play.
- When you select “REP1”, that title/chapter/track is repeated endlessly until “REP1” is canceled.
- You cannot select “REP” and “ALL DISCS SHUF” at the same time.
- You cannot select “REP1” for JPEG image files.
- If you select “ALL” the program repeats up to five times.

Tip

If you set Repeat Play when the playback is stopped, press REPEAT repeatedly to select the setting, then press \triangleleft to start Repeat Play.

Creating your own program

— Program Play



You can make a program of up to 25 steps.

You can synchro record the programmed tracks onto a tape (page 44).

Using the front panel display

- 1 Press **DVD**.
- 2 Press **PLAY MODE** in stop mode repeatedly until “**PGM**” lights up in the display.
- 3 Press **DISC SKIP EX-CHANGE** (or **D.SKIP** on the remote) or **DISC 1~3** buttons to select a disc.
- 4 Press **◀◀** or **▶▶** repeatedly until the title or track number you want appears.
When programming an MP3 audio tracks, press **ALBUM +** or **-** to select album, then press **◀◀** or **▶▶** repeatedly until the track number you want appears.
- 5 Press **PUSH ENTER** (or **ENTER** on the remote).
The track is programmed. The program step number appears.
- 6 To program additional tracks, repeat steps 4 and 5.
- 7 Press **◀▶**.
Program Play starts.

Using the on-screen display

Use buttons on the remote for this operation.

- 1 Press **DVD DISPLAY**.
The Control Menu appears.
- 2 Press **PLAY MODE** in stop mode repeatedly until “**PGM**” appears in the display.
The Program Display appears on the screen.

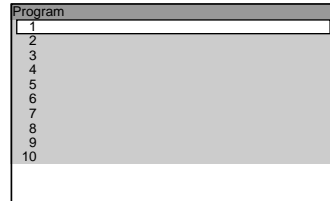

- 3 Press **➡**, then press **↑** or **↓** repeatedly to select the disc you want. Press **➡**.

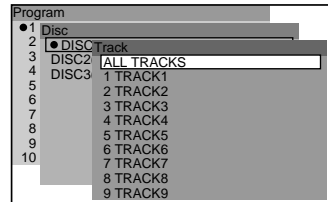

* “-----” appears when the system has not loaded the disc information in the memory.

4 Select the album or track you want to program.

■ When programming a VIDEO CD or audio CD track

For example, select track “6”.

Press **↑** and **↓** or the numeric buttons to select “6”, then press **ENTER**.

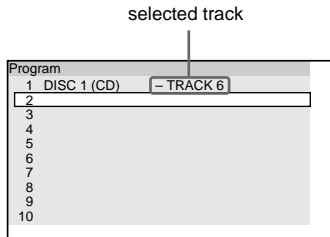

■ When programming an MP3 audio track

For example, select track “3” of album “2”. Press **↑** and **↓** to select “2”, then press **→**.

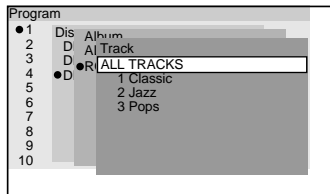

Next, press **↑** and **↓** or the numeric buttons to select “3”, then press **ENTER**.

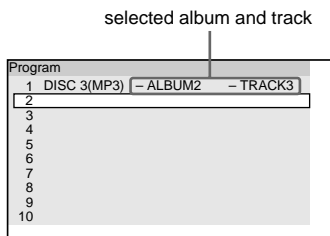

5 To program other tracks, repeat step 4.

6 Press **◀▶.**

Program play starts.

When the program ends, you can restart the same program again by pressing **◀▶**.

Other Operations

To	Do this
Return to Normal Play	Press CLEAR during play.
Cancel Program Play	Press PLAY MODE in stop mode repeatedly until “PGM” disappear.
Clear a track from the end of the program	Press CLEAR when playback is stopped.

Notes

- Program Play function is not available for DVD and JPEG image file.
- When you switch the play mode to “PGM” while “REP1” is selected, “REP1” is automatically canceled.

Tip

The program you made remains in the system’s memory even after Program Play finishes. Press **◀▶** to play the same program again.

Searching for a title/ chapter/track/index/ album/file



You can search a title (DVD), chapter (DVD), track (audio CD, VIDEO CD, MP3), index (VIDEO CD), and album (MP3 audio tracks, JPEG) and file (JPEG image files). As titles, tracks, albums, chapters, indexes and files are assigned unique numbers on the disc, you can select the number you want from the Control Menu on the on-screen display. You can also search for a particular point using the time code (Time Search).

Searching for a title/track/ album/file

Use buttons on the remote for this operation.

1 Press DVD DISPLAY.

The Control Menu appears on the on-screen display.

2 Press **↑** or **↓** repeatedly to select the search method.

■ When playing a DVD

“TITLE”

■ When playing a VIDEO CD without PBC function

“TRACK”

■ When playing an audio CD

“TRACK”

■ When playing an MP3 audio track

“ALBUM” or “TRACK”

■ When playing a JPEG image file

“ALBUM” or “FILE”

3 Press ENTER.

The list of contents in the disc appears.

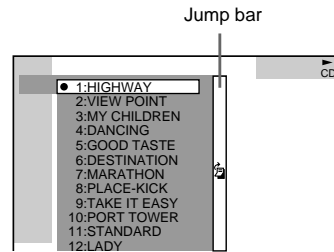

When the list of all tracks or albums cannot be displayed on the window, the jump bar appears. Press **→** to select the jump bar icon, and then scroll the jump bar to display the rest of the list using **↑** or **↓**. Press **←** or RETURN **↵** to return to the track or the album list.

4 Press **↑** or **↓** to select the track you want then press ENTER.

The system starts playback from the selected track.

Searching for a chapter/index

Use buttons on the remote for this operation.

1 Press DVD DISPLAY.

The Control Menu appears on the on-screen display.

2 Press **↑** or **↓** to select the search method.

■ **When playing a DVD**
“CHAPTER”

■ **When playing a VIDEO CD**
“INDEX”

“**(**)” is selected (** refers to a number).

The number in parentheses indicates the total number of chapters or indexes.

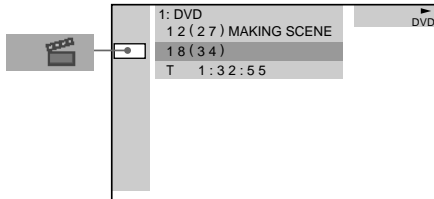

3 Press ENTER.

“**(**)” changes to “- -(**)”.

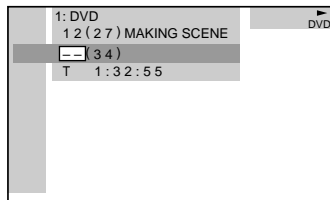

4 Press **↑** or **↓** repeatedly, or press the numeric buttons to select the chapter or index number you want to search.

If you make a mistake, press CLEAR to cancel the number, then select another number.

5 Press ENTER.

The playback starts from the selected number.

To turn off the Control Menu

Press DVD DISPLAY repeatedly until the Control Menu disappears.

To cancel searching

Press RETURN .

To search for a particular point using the time code

— Time Search

Use buttons on the remote for this operation.

1 In step 2, select “TIME”.

“T **: **: **” (playing time of the current title or track) is selected.

2 Press ENTER.

“T - : - : - : - : - : - :” appears above “T **: **: **”.

3 Input the time code using the numeric buttons, then press ENTER.

For example, to find the scene at 2 hours, 10 minutes, and 20 seconds after the beginning, enter “2:10:20”.

Notes

- The title, chapter or track number displayed on the TV screen is recorded data on the disc.
- You cannot search a scene of a VIDEO CD.
- If you play a DVD, input the playing time of the current title using the time code. If you play an audio CD, VIDEO CD or MP3 audio track, input the playing time of the current track using the time code.

Tip

You can change the display to show playing time or remaining time. For details, see “checking the playing time, remaining time and titles (DVD/VIDEO CD/CD/MP3/JPEG)” (page 51).

DVD – Various functions

Changing the sound/ subtitle/language



Changing the sound (DVD only)

If a DVD is recorded with multilingual tracks, you can select the language you want while playing the DVD. If the DVD is recorded in multiple audio formats (PCM, Dolby Digital, MPEG audio, or DTS), you can select the audio format you want while playing the DVD.

Use buttons on the remote for this operation.

1 Press DVD DISPLAY during playback.

The Control Menu appears on the on-screen display.

2 Press ↑ or ↓ repeatedly to select “AUDIO”, then press ENTER.

The options for “AUDIO” appears.

3 Press ↑ or ↓ repeatedly to select the audio signal you want.

Depending on the DVD, the choice of the language and audio format varies. When 4-digit is displayed, they represent the language code (see “Language code list” on back page). When the same language is displayed twice or more times, the DVD is recorded in multiple audio formats.

4 Press ENTER.

To turn off the Control Menu

Press DVD DISPLAY repeatedly until the Control Menu disappears.

Notes

- For discs not recorded in multiple audio format, you cannot change the sound.
- During DVD playback, the sound may change automatically.

Tip

You can select the audio setting by pressing AUDIO on the remote. Each time you press the button, the setting changes.

Displaying the audio information of the disc (DVD only)

When you select “AUDIO”, the channels being played are displayed on the screen.

For example, in Dolby Digital format, multiple signals ranging from monaural to 5.1 channel signals can be recorded on a DVD. Depending on the DVD, the number of recorded channels may differ.

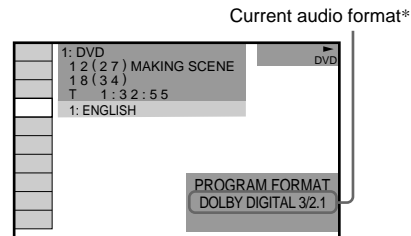

* “PCM”, “DTS”, or “DOLBY DIGITAL” is displayed. For “DOLBY DIGITAL”, the channels in the playing track are displayed numerically as follows:

For Dolby Digital 5.1 ch:

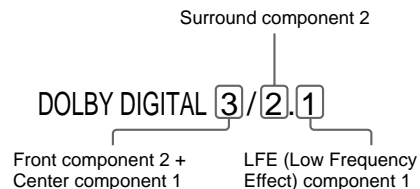

The display examples are as follows:

- PCM (stereo)

PROGRAM FORMAT
PCM 48kHz 24bit

- Dolby Surround

PROGRAM FORMAT
DOLBY DIGITAL 2/0
DOLBY SURROUND

- Dolby Digital 5.1ch

PROGRAM FORMAT
DOLBY DIGITAL 3/2.1

- DTS

PROGRAM FORMAT
DTS 3/2.1

Displaying the subtitles (DVD only)

You can change the subtitle language while playing a DVD, or turn the subtitles on or off whenever you want with DVDs on which multilingual subtitles are recorded.

For example you can select the language you want to master and turn the subtitles on for better understanding.

Use buttons on the remote for this operation.

1 Press DVD DISPLAY during playback.

The Control Menu appears on the on-screen display.

2 Press ↑ or ↓ repeatedly to select “SUBTITLE”, then press ENTER.

The option for “SUBTITLE” appears.

3 Press ↑ or ↓ repeatedly to select language you want, then press ENTER.

The subtitles are displayed in the selected language.

When 4-digit is displayed, they represent the language code (see “Language code list” on back page).

To cancel the SUBTITLE setting

Select “OFF” in step 3.

To turn off the Control Menu

Press DVD DISPLAY repeatedly until the Control Menu disappears.

Note

Depending on the DVD, you may not be able to change the subtitles even if multilingual subtitles are recorded on the DVD.

Tip

You can select the subtitle language by pressing SUBTITLE. Each time you press the button, the language changes.

Changing the on-screen display language, DVD menu language and audio track auto selection mode

— LANGUAGE SETUP/CUSTOM SETUP

Use buttons on the remote for this operation.

1 Press DVD SETUP in stop mode.

The Setup Menu appears on the on-screen display.

2 Press ↑ or ↓ repeatedly to select “LANGUAGE SETUP” or “CUSTOM SETUP”, then press ENTER.

Select	Setup item
LANGUAGE SETUP	OSD
	DVD MENU
	AUDIO
	SUBTITLE
CUSTOM SETUP	TRACK SELECTION
	AUDIO DRC
	DATA CD PRIORITY
	JPEG DATE

continued

Changing the sound/subtitle/ language (continued)

3 Press **↑** or **↓** repeatedly to select an item, then press **ENTER**.

4 Press **↑** or **↓** repeatedly to select a setting, then press **ENTER**.

Note

When the selected language is not recorded on the DVD, one of the recorded language is automatically selected (except for "OSD").

Tips

- You can reset all the DVD settings except for Parental Control by performing the operations described under "To return the DVD setup to the default settings, perform reset as follows:" (page 67).
- If you select "OTHERS →" in "DVD MENU", "AUDIO" or "SUBTITLE", select and enter the language code from the language code list using the numeric buttons (back page). The selected language code (4-digit) is displayed the next time you select "OTHERS →".

■ **OSD (on-screen display)**

Switches the display language on the screen. Select the language from the displayed list.

■ **DVD MENU (DVD only)**

Select the language for the DVD menu.

■ **AUDIO (DVD only)**

Switches the language of the sound track. Select the language from the displayed list.

■ **SUBTITLE (DVD only)**

Switches the language of the subtitle. Select the language from the displayed list.

■ **TRACK SELECTION (DVD only)**

Gives the priority to the sound track which contains the highest number of channels when you play a DVD on which multiple audio formats (PCM, MPEG audio, DTS, or Dolby Digital format) are recorded.

<u>OFF</u>	No priority given.
<u>AUTO</u>	Priority given.

■ **AUDIO DRC* (DVD only)**

Narrows the DYNAMIC range of the soundtrack. Useful for watching movies at low volume late at night.

<u>OFF</u>	No compression of DYNAMIC range.
<u>STANDARD</u>	Reproduces the soundtrack with the kind of DYNAMIC range that the recording engineer intended.
<u>MAX</u>	Narrows the DYNAMIC range fully.

* DRC: Dynamic Range Compression.

Note

DYNAMIC range compression works with Dolby Digital source only.

■ DATA CD PRIORITY (MP3 audio tracks, JPEG image files only)

Set priority data you want to play, when you play the data disc (CD-ROM/CD-R/CD-RW) contained MP3 audio tracks and JPEG image files.

MP3	If an MP3 audio track exists on the disc, the system recognizes the disc as a “disc with MP3 audio tracks”. If only JPEG image files exist on the disc, the system recognizes the disc as a “disc with JPEG image files”.
JPEG	If a JPEG image file exists on the disc, the system recognises the disc as a “disc with JPEG image files”. If only MP3 audio tracks exist on the disc, the system recognises the disc as a “disc with MP3 audio tracks”.

■ JPEG DATE

Change the date display format of a JPEG image file in the Control Menu.

MM/DD/YYYY

YYYY/MM/DD

DD/MM/YYYY

YYYY/DD/MM

YYYY: Year

MM: Month

DD: Day

Notes

- When you set to “AUTO”, the language setting may change. The “TRACK SELECTION” setting has higher priority than the “AUDIO” setting in “LANGUAGE SETUP”.
- If PCM, MPEG audio, DTS and Dolby Digital sound tracks have the same number of channels, the system selects PCM, DTS, Dolby Digital and MPEG audio sound tracks in this order.
- Depending on the DVD, the audio channel with priority may be predetermined. In this case, you cannot give priority to the DTS, or Dolby Digital, or PCM or MPEG audio format by selecting “AUTO”.

Adjusting the angle/image



Changing the angles (DVD only)

When playing a DVD on which various angles (multi-angles) for a scene are recorded, the “ANGLE” icon indicator lights in green on the on-screen display. This means that you can change the viewing angle. For example, while playing a scene of a train in motion, you can display the view from either the front of the train, the left window of the train or from the right window without having the train’s movement interrupted.

Use buttons on the remote for this operation.

- 1 Press DVD DISPLAY during playback.**
The Control Menu appears on the on-screen display.
- 2 Press ↑ or ↓ repeatedly to select the “ANGLE”.**
The angle number appears. The number in parentheses indicates the total number of angles. The “ANGLE” icon indicator lights up in green when angles are recorded on the disc.
- 3 Press ENTER.**
The angle number changes to “-”.
- 4 Select the angle you want using the numeric buttons or ↑ and ↓, then press ENTER.**
The angle is changed to the selected angle.

continued

Adjusting the angle/image (continued)

To turn off the Control Menu
Press DVD DISPLAY repeatedly until the
Control Menu disappears.

Note

Depending on the DVD, you may not be able to
change the angles even if multi-angles are recorded
on the DVD.

Tip

You can select the angle by pressing ANGLE. Each
time you press the button, the angle changes.

Adjusting the TV screen

— SCREEN SETUP/CUSTOM SETUP

Use buttons on the remote for this operation.

1 Press DVD SETUP in stop mode.

The Setup Menu appears on the on-screen
display.

2 Press \uparrow or \downarrow repeatedly to select “SCREEN SETUP” or “CUSTOM SETUP”, then press ENTER.

Select	Setup item
SCREEN SETUP	TV TYPE SCREEN SAVER BACKGROUND COMPONENT OUT
CUSTOM SETUP	VCD COLOR SYSTEM*

* Except for Latin American model

3 Press \uparrow or \downarrow repeatedly to select an item, then press ENTER.

4 Press \uparrow or \downarrow repeatedly to select a setting, then press ENTER.

■ TV TYPE (DVD only)

Select the aspect ratio of the connected TV.

16:9	Select this when you connect a wide-screen TV or a TV with a wide mode function.
4:3 LETTER BOX	Select this when you connect a 4:3 screen TV. This setting displays a wide picture with bands displayed on the upper and lower portions of the screen.
4:3 PAN SCAN	Select this when you connect a 4:3 screen TV. This setting displays a wide picture on the entire screen and cuts off the portions that do not fit.

• 16:9

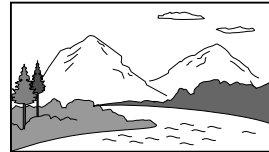

• 4:3 LETTER BOX



• 4:3 PAN SCAN

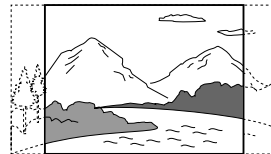

Note

Depending on the DVD, “4:3 LETTER BOX” may be
selected automatically instead of “4:3 PAN SCAN”
or vice versa.



■ SCREEN SAVER

Turn on and off the screen saver. If you turn on the screen saver, the screen saver image appears when you leave the system in pause or stop mode for 15 minutes or when you play an audio CD or MP3 audio tracks or JPEG image files (except during slide show) for more than 15 minutes. The screen saver will help prevent your display device from becoming damaged (ghosting). Press any DVD related button to turn off the screen saver.

<u>ON</u>	Turns on the screen saver.
<u>OFF</u>	Turns off the screen saver.

■ BACKGROUND

Select the background color or picture on the TV screen when the playback is stopped or while playing an audio CD or MP3 audio tracks.

<u>JACKET PICTURE</u>	The jacket picture (still picture) appears in the background, but only when the jacket picture is already recorded on the DVD. If the disc does not contain a jacket picture, the "GRAPHICS" picture appears.
<u>GRAPHICS</u>	The preset picture stored in the system appears in the background.
<u>BLUE</u>	The background color is blue.
<u>BLACK</u>	The background color is black.

■ COMPONENT OUT

Change the type of signal output from the COMPONENT VIDEO OUT jacks on the system.

<u>INTERLACE</u>	Select this when you are connected to a standard (interlace format) TV.
<u>PROGRESSIVE</u>	Select this when you have a TV that can accept progressive signals.

To force the system to switch to interlace when PROGRESSIVE is selected

Make sure the function is set to DVD, then hold down ■ and press DVD MENU.

Notes

- "PROGRESSIVE" does not work for PAL signals. Even if you set "COMPONENT OUT" to "PROGRESSIVE" the output signals is automatically switched to interlace format for PAL signals.
- When "COMPONENT OUT" is set to "PROGRESSIVE", no video signal is output from the VIDEO OUT or S VIDEO OUT jacks.

■ VCD COLOR SYSTEM

Select the color system when you play a VIDEO CD.

<u>AUTO</u>	Outputs the video signal according to the color system of the disc, either PAL or NTSC. If your TV uses a DUAL system, select AUTO.
<u>PAL</u>	Changes the video signal of an NTSC disc and outputs it in the PAL system.
<u>NTSC</u>	Changes the video signal of a PAL disc and outputs it in the NTSC system.

Notes

- You cannot change the color system of the disc itself.
- You can change the color system of this system according to the connected TV (page 12).

Restricting disc playback

— CUSTOM PARENTAL CONTROL/ PARENTAL CONTROL



Preventing playback of specific discs

— CUSTOM PARENTAL CONTROL

You can set the playback restrictions so that the system will not play inappropriate discs. You can set the same Custom Parental Control password for up to 25 discs. When you set the twenty-sixth disc, the playback restriction for the first disc is canceled.

Use buttons on the remote for this operation.

- 1 Insert the disc you want to set the playback restriction.**
If the disc is playing, press ■ to stop playback.
- 2 Press DVD DISPLAY in stop mode.**
The Control Menu appears on the on-screen display.
- 3 Press ↑ or ↓ repeatedly to select the “CUSTOM PARENTAL CONTROL”, then press ENTER.**
The “CUSTOM PARENTAL CONTROL” is selected.
- 4 Press ↑ or ↓ repeatedly to select the “ON→”, then press ENTER.**

- **If you have not entered a password**
The display for registering a new password appears on the on-screen display.



Enter a 4-digit password using the numeric buttons, then press ENTER. The display for confirming the password appears.

- **When you have already registered a password**

The display for entering the password appears on the on-screen display.

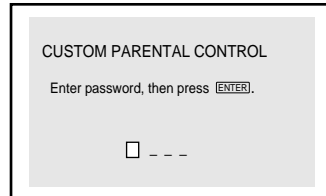

- 5 Enter or re-enter your 4-digit password using the numeric buttons, then press ENTER.**

“Custom parental control is set.” appears and the screen returns to the Control Menu.

If you make a mistake entering your password

Press ← before you press ENTER and input the correct number.

If you make a mistake

Press RETURN ↵, then start from step 3 again.

To turn off the Control Menu

Press RETURN ↵, then press DVD DISPLAY repeatedly until the Control Menu disappears.

To turn off the Custom Parental Control function

- 1 In step 4, select “OFF→”, then press ENTER.**
- 2 Enter your 4-digit password using the numeric buttons, then press ENTER.**

To change the password

- 1 In step 4, select “PASSWORD→”, then press ENTER.

The display for entering the password appears.

- 2 Enter your 4-digit password using the numeric buttons, then press ENTER.
- 3 Enter a new 4-digit password using the numeric buttons, then press ENTER.
- 4 To confirm your password, re-enter it using the numeric buttons, then press ENTER.

Playing the disc for which Custom Parental Control is set

Use buttons on the remote for this operation.

- 1 Insert the disc for which Custom Parental Control is set.
The “CUSTOM PARENTAL CONTROL” display appears on the on-screen display.

- 2 Enter your 4-digit password using the numeric buttons, then press ENTER.
The system is ready for playback.

Tip

If you forgot your password, enter the 6-digit number “199703” using the numeric buttons on the remote when the “CUSTOM PARENTAL CONTROL” display ask you for your password, then press ENTER. The display will ask you to enter a new 4-digit password.

Limiting playback by children (DVD only)

— Parental Control

You can limit the playback of some DVDs according to a predetermined level such as the age of the users. The same password is used for both Custom Parental Control and Parental Control.

When a limited scene is played back, that scene is skipped or replaced with a preset scene.

Use buttons on the remote for this operation.

- 1 Press DVD SETUP in stop mode.
The Setup Menu appears on the on-screen display.
- 2 Press ↑ or ↓ repeatedly to select “CUSTOM SETUP”, then press ENTER.
The “CUSTOM SETUP” display appears on the on-screen display.

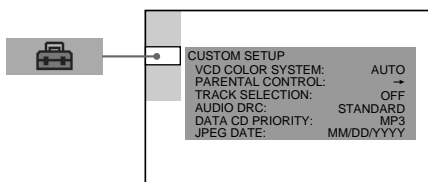

- 3 Press ↑ or ↓ repeatedly to select “PARENTAL CONTROL→”, then press ENTER.

■ If you have not entered a password

The display for registering a new password appears on the on-screen display.

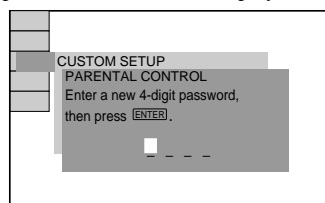

Enter a 4-digit password using the numeric buttons on the remote, then press ENTER. The display for confirming the password appears.

continued

Restricting disc playback (continued)

■ When you have already registered a password

The display for entering the password appears.

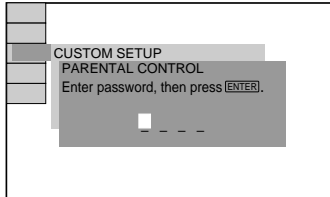

4 Enter or re-enter your 4-digit password using the numeric buttons on the remote, then press ENTER.

The display for setting the playback limitation level and changing the password appears.

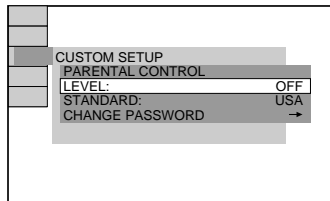

5 Press ↑ or ↓ repeatedly to select “STANDARD”, then press ENTER.

The options for “STANDARD” appears.

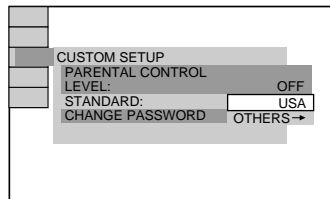

6 Press ↑ or ↓ repeatedly to select a geographic area as the playback limitation level, then press ENTER.

The area is selected.

When you select “OTHERS→”, enter the standard code in the table on page 35 using the numeric buttons.

7 Press ↑ or ↓ repeatedly to select “LEVEL”, then press ENTER.

The option for “LEVEL” appears.

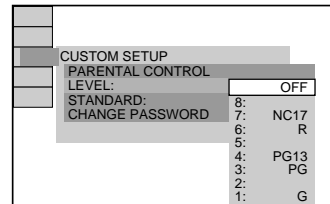

8 Press ↑ or ↓ repeatedly to select the level you want, then press ENTER.

The Parental Control setting is completed.

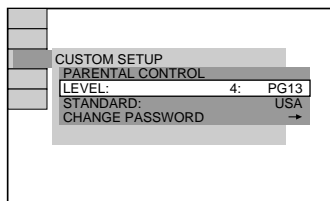

The lower the value, the more strict the limitation.

If you make a mistake

Press ← or RETURN ↵ to go back to the previous screen.

To turn off the Setup Menu

Press DVD SETUP repeatedly until the Setup Menu disappears.

To turn off the Parental Control function

Set "LEVEL" to "OFF" in step 8.

To change the password

1 In step 5, to select "CHANGE PASSWORD →", then press ENTER.

The display for entering the password appears.

2 Follow step 3 to enter a new password.

Playing the disc for which Parental Control is set

Use buttons on the remote for this operation.

1 Insert the disc and press ◀▶.

The "PARENTAL CONTROL" display appears.

2 Enter your 4-digit password using the numeric buttons, then press ENTER.

Playback starts.

Notes

- When you play DVDs which do not have the Parental Control function, playback cannot be limited on this system.
- Depending on the DVD, you may be asked to change the parental control level while playing the disc. In this case, enter your password, then change the level. If the Resume Play mode is canceled, the level returns to the original level.

Tip

If you forgot your password, remove the disc and repeat steps 1 to 3 of "Limiting playback by children (for DVD only)" (page 33). When you are asked to enter your password, enter "199703" using the numeric buttons on the remote, then press ENTER. The display will ask you to enter a new 4-digit password. After you enter a new 4-digit password, replace the disc in the system and press ◀▶. When the "PARENTAL CONTROL" display appears, enter your new password.

Area code

Standard	Code number
Argentina	2044
Australia	2047
Austria	2046
Belgium	2057
Brazil	2070
Canada	2079
Chile	2090
China	2092
Denmark	2115
Finland	2165
France	2174
Germany	2109
Hong Kong	2219
India	2248
Indonesia	2238
Italy	2254
Japan	2276
Korea	2304
Malaysia	2363
Mexico	2362
Netherlands	2376
New Zealand	2390
Norway	2379
Pakistan	2427
Philippines	2424
Portugal	2436
Russia	2489
Singapore	2501
Spain	2149
Sweden	2499
Switzerland	2086
Taiwan	2543
Thailand	2528
United Kingdom	2184

Speaker settings

— SPEAKER SETUP

To obtain the best possible surround sound, set the size of the speakers you have connected and their distance from your listening position. Then use the test tone to adjust the volume and the balance of the speakers to the same level.

Setting the speaker size and distance

Use buttons on the remote for this operation.

- 1 Press **DVD SETUP** in stop mode.
The Setup Menu on the on-screen display appears.
- 2 Press **↑** or **↓** repeatedly to select **“SPEAKER SETUP”**, then press **ENTER**.
- 3 Press **↑** or **↓** repeatedly to select **“SIZE”** or **“DISTANCE”**, then press **ENTER**.
- 4 Press **↑** or **↓** repeatedly to select the setup item, then press **ENTER**.
- 5 Press **↑** or **↓** repeatedly to select or set a setting, then press **ENTER**.

■ SIZE

When you do not connect center speaker, surround speakers or sub woofer, or you move the surround speakers, set the parameters for **CENTER**, **SURROUND** and **SUBWOOFER**. Since the front speaker setting is fixed, you cannot change it.

FRONT	YES
CENTER	<u>YES</u> : Normally select this position. NONE: Select this when center speaker is not used.
SURROUND	<u>YES</u> : Normally select this. NONE: Select this when surround speakers are not used.
SUBWOOFER	<u>NONE</u> : Normally select this. YES: Select this when an optional sub woofer is used.

Notes

- Depending on the settings of other speakers, the sub woofer may output the accessive sound.
- When you play a DVD that does not have sub woofer output recorded, note that no sound is produced from the sub woofer, even if “SUBWOOFER” is set to “YES”.
- When connecting a sub woofer, make sure to set the SUBWOOFER setting to “YES”. If set to “NONE”, no sound is output from the sub woofer.

■ DISTANCE

The default distance setting for the speakers in relation to the listening position is shown below.

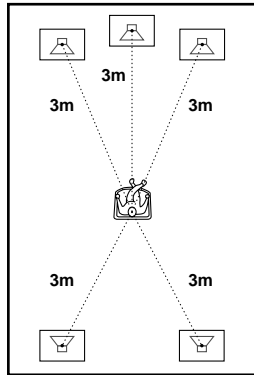

Be sure to change the value in the Setup Menu when you move the speakers.

FRONT <u>3.0 m</u>	Front speaker distance from the listening position can be set in 0.2 meter increments from 1.0 to 7.0 meters.
CENTER <u>3.0 m</u>	Center speaker distance can be moved up to 1.6 meters closer to the listening position, from the front speakers in 0.2 meter increments.
SURROUND <u>3.0 m</u>	Surround speaker distance can be moved up to 4.6 meters closer to the listening position, from the front speakers, in 0.2 meter increments.

Notes

- If each of the front and surround speakers are not placed at an equal distance from your listening position, set the distance of the closest speaker.
- Do not place the surround speakers farther away from your listening position than the front speakers.

Adjusting the speaker volume and level

Use buttons on the remote for this operation.

- 1 **Press DVD SETUP in stop mode.**
The Setup Menu appears on the on-screen display.
- 2 **Press ↑ or ↓ repeatedly to select “SPEAKER SETUP”, then press ENTER.**
- 3 **Press ↑ or ↓ repeatedly to select “TEST TONE”, then press ENTER.**
- 4 **Press ↑ or ↓ repeatedly to select “ON”, then press ENTER.**
You will hear the test tone from each speaker in sequence.
- 5 **From your listening position, adjust the value of “BALANCE” and “LEVEL” using ↑ and ↓ or ← and →.**
The test tone is emitted from selected speakers during “LEVEL” or “BALANCE” adjustment.
- 6 **Press ENTER when you finish adjusting.**
- 7 **Press ↑ or ↓ repeatedly to select “TEST TONE”, then press ENTER.**
- 8 **Press ↑ or ↓ repeatedly to select “OFF”, then press ENTER.**

Tip

To adjust the balance or the level without listening to the test tone, select “BALANCE” or “LEVEL” in step 3 and press ENTER, then adjust the balance or level using ↑ or ↓ and press ENTER.

continued

Speaker settings (continued)

■ LEVEL

You can vary the level of each speaker as follows. Be sure to set “TEST TONE” to “ON” for easy adjustment.
The default settings are underlined.

CENTER <u>0 dB</u>	Adjust the level of the center speaker (–6 dB to +6 dB, 1 dB increments).
SURROUND LEFT <u>0 dB</u>	Adjust the level of the surround speakers (–6 dB to +6 dB, 1 dB increments).
SURROUND RIGHT <u>0 dB</u>	
SUBWOOFER <u>0 dB</u>	Adjust the level of the sub woofer (–10 dB to + 10 dB, 1 dB increments).

■ BALANCE

You can vary the balance of the left and right speakers as follows. Be sure to set “TEST TONE” to “ON” for easy adjustment.
The default settings are underlined.

FRONT <u>---</u> (CENTER)	Adjust the balance between the front left and right speakers (6 steps left or right).
------------------------------	---

■ TEST TONE

The speakers will emit a test tone to adjust “BALANCE” and “LEVEL”.
The default settings are underlined.

<u>OFF</u>	The test tone is not emitted from the speakers.
ON	The test tone is emitted from each speaker in sequence while adjusting balance or level. The test tone is emitted from selected speakers during “LEVEL” or “BALANCE” adjustment.

Note

When you adjust the level of the sub woofer, set “TEST TONE” to “OFF”.

List of items that can be displayed and selected by disc type

When you press DVD DISPLAY on the remote, the following control menu items are displayed.

Control Menu items	Function
 DISC	Displays the disc title or disc type inserted into the system. Select the disc to be played.
 TITLE (DVD only) SCENE (VIDEO CD in PBC playback only) TRACK (VIDEO CD only)	Select the title (DVD), the scene (VIDEO CD in PBC playback), the track (VIDEO CD) to be played.
 CHAPTER (DVD only) INDEX (VIDEO CD only)	Select the chapter (DVD) or the index (VIDEO CD) to be played.
 ALBUM (MP3 audio track only)	Select the album (MP3 audio track) to be played.
 TRACK (Audio CD/MP3 audio track only)	Select the track (Audio CD/MP3 audio track) to be played.
 INDEX (CD only)	Display the index and select the index (Audio CD) to be played.
 TIME	Check the playing time and the remaining time. Input the time code for picture and music searching.
 AUDIO (DVD only)	Change the audio format setting.
 SUBTITLE (DVD only)	Display the subtitles. Change the subtitles language.
 ALBUM (JPEG image file only)	Select the album of JPEG image files to be played.
 FILE (JPEG image file only)	Select the JPEG image file to be played.
 DATE (JPEG image file only)	Display the date information.
 ANGLE (DVD only)	Changes the angle.
 PLAY MODE*	Select the play mode (Normal Play/Shuffle Play/Program Play) for the disc.
 REPEAT	Play the entire disc (all titles/all tracks/all files), one title/chapter/track/album/file or contents of program repeatedly.
 CUSTOM PARENTAL CONTROL	Set the disc to prohibit playback.

* For DVD and JPEG image files, only Normal Play is available.

Tips

- Each time you press DVD DISPLAY, the Control Menu display changes cyclically as follows:
Control Menu display → Control Menu display off
The Control Menu items different depending on the disc.
- The “REPEAT” icon indicator lights up in green when you select any item except “OFF”.
- The “ANGLE” icon indicator lights in green only when multiple angles are recorded on the disc.

System setup item list

When you press DVD SETUP on the remote, the following settings are displayed. The default settings are underlined.

LANGUAGE SETUP (page 27)

OSD	Select the language you want to use from the displayed language list.
DVD MENU	Select the language you want to use from the displayed language list.
AUDIO	Select the language you want to use from the displayed language list.
SUBTITLE	Select the language you want to use from the displayed language list.

SCREEN SETUP (page 30)

TV TYPE	16:9 4:3 LETTER BOX 4:3 PAN SCAN
SCREEN SAVER	<u>ON</u> OFF
BACKGROUND	<u>JACKET PICTURE</u> GRAPHICS BLUE BLACK
COMPONENT OUT	<u>INTERLACE</u> PROGRESSIVE

CUSTOM SETUP (page 27, 30)

VCD COLOR SYSTEM*1	<u>AUTO</u> PAL NTSC
PARENTAL CONTROL→	
TRACK SELECTION	<u>OFF</u> AUTO
AUDIO DRC	OFF <u>STANDARD</u> MAX
DATA CD PRIORITY	<u>MP3</u> JPEG
JPEG DATE	<u>MM/DD/YYYY</u> YYYY/MM/DD DD/MM/YYYY YYYY/DD/MM

SPEAKER SETUP (page 36)

SIZE	FRONT	<u>YES</u>
	CENTER	<u>YES</u> NONE
	SURROUND	<u>YES</u> NONE
	SUB WOOFER	<u>NONE</u> YES
DISTANCE	FRONT	<u>3.0 m</u> (1.0 m - 7.0 m)
	CENTER	<u>3.0 m</u> (1.0 m - 7.0 m)
	SURROUND	<u>3.0 m</u> (1.0 m - 7.0 m)
LEVEL	CENTER	<u>0 dB</u> (-6 dB - +6 dB)
	SURROUND LEFT	<u>0 dB</u> (-6 dB - +6 dB)
	SURROUND RIGHT	<u>0 dB</u> (-6 dB - +6 dB)
	SUBWOOFER	0 dB (-10 dB - +10 dB)
BALANCE	FRONT	<u>--</u> (6 steps left or right)
TEST TONE		<u>OFF</u> ON

RESET

YES
NO

*1 Except for Latin American model

Presetting radio stations

You can preset up to 20 FM stations and 10 AM stations. You can then tune in any of those stations simply by selecting the corresponding preset number.

There are two ways to store the station presets.

To	Do this
Automatically tune in all of the stations that can be received in your area and store your favourite stations manually	Setting presets through automatic tuning
Manually tune in and store the radio frequency of your favourite stations	Setting presets through manual tuning

Setting presets through automatic tuning

- 1 Press **TUNER/BAND** repeatedly to select “FM” or “AM”.
- 2 Press and hold **▶▶** or **◀◀** (or **TUNING +** or **-** on the remote) until “AUTO” appears in the display and the frequency indication starts to change, then release.

Scanning stops when the system tunes in a station. “TUNED” and “STEREO” (for a stereo program) lights up in the display.

- 3 Press **TUNER MEMORY**.

A preset number appears in the display. The stations are stored from preset number 1.

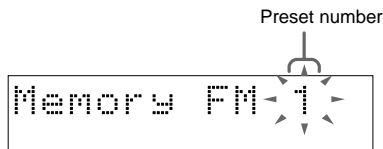

- 4 Press **▶▶** or **◀◀** (or **PRESET +** or **-** on the remote) repeatedly to select the preset number you want to store.

- 5 Press **PUSH ENTER** (or **ENTER** on the remote).

“Complete!” appears in the display. The station is stored.

- 6 Repeat steps 1 to 5 to store other stations.

Setting presets through manual tuning

- 1 Press **TUNER/BAND** repeatedly to select “FM” or “AM”.

- 2 Press **▶▶** or **◀◀** (or **TUNING +** or **-** on the remote) repeatedly to tune in the station you want.

- 3 Press **TUNER MEMORY**.

A preset number appears in the display. The stations are stored from preset number 1.

- 4 Press **▶▶** or **◀◀** (or **PRESET +** or **-** on the remote) repeatedly to select the preset number you want.

- 5 Press **PUSH ENTER** (or **ENTER** on the remote).

“Complete!” appears in the display. The station is stored.

- 6 Repeat steps 1 to 5 to store other stations.

Other Operations

To	Do this
Tune in a station with a weak signal	Follow the procedure described in “Setting presets through manual tuning”.
Set another station to an existing preset number	Start over from step 1. After step 3, press ▶▶ or ◀◀ (or PRESET + or - on the remote) repeatedly to select the preset number you want to store the other station.

continued

Presetting radio stations (continued)

To improve tuner reception

When the tuner reception is poor, set the DVD power manage function to “DVD POWER OFF”. The default setting is “DVD POWER ON”. Use buttons on the system for the operation.

- 1 Press **DVD**.
- 2 Press **I/⏻** to turn off the system.
- 3 Press **I/⏻** while holding **■**.
“DVD POWER OFF” appears.

To set DVD power on

Repeat the procedure above and “DVD POWER ON” appears.

Notes

- When “DVD POWER OFF” is selected, the DVD access time is increased.
- You cannot change the setting in Power Saving Mode.

To change the AM tuning interval

The factory settings for AM tuning interval is 9 kHz (10 kHz in some areas). To change the AM tuning interval, select any AM station first, then turn off the power. While holding down the AMP MENU button, turn the power back on. When you change the interval, AM preset stations will be erased. To reset the interval, repeat the same procedure. Use buttons on the system for the operation.

Tips

- The preset stations are retained for half a day even if you unplug the power cord or if a power failure occurs.
- If you press TUNER/BAND while the power is off, the power turns on automatically and TUNER is selected as a function.

Listening to the radio

You can listen to a radio station either by selecting a preset station, or by manually tuning in the station.

Listening to a preset station

— Preset Tuning

Before tuning to preset stations, be sure to preset them (see “Presetting radio stations” on page 41).

- 1 Press **TUNER/BAND** repeatedly to select “FM” or “AM”.
- 2 Press **▶▶** or **◀◀** (or **PRESET +** or **–** on the remote) repeatedly to tune in the preset station you want.

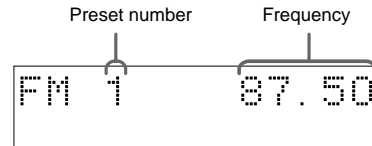

Tip

You can use the numeric button on the remote to select a preset station. Press >10, then press numeric buttons to enter the preset number over 10.

Listening to non-preset radio station

— Manual Tuning

- 1 Press **TUNER/BAND** repeatedly to select “FM” or “AM”.
- 2 Press **▶▶** or **◀◀** (or **TUNING +** or **–** on the remote) repeatedly to tune in the station you want.

Tips

- To improve broadcast reception, adjust the supplied antennas.
- When an FM stereo program has static noise, press **FM MODE** repeatedly until “MONO” appears. There will be no stereo effect, but the reception will improve.
- Press and hold **▶▶** or **◀◀** (or **TUNING +** or **–** on the remote). The frequency indication changes and scanning stops when the system tunes in a station (Automatic Tuning).
- To record from the radio, see “Recording to a tape” on page 44 or “Timer-recording radio programs” on page 45.

Tape

Loading a tape

- 1 Press **TAPE A/B** repeatedly to select deck A or B.
- 2 Press **▲** on the selected deck.
- 3 Insert a tape in deck A or B.

Insert with the side you want to play/record facing forward.

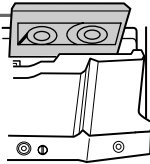

Playing a tape

You can use TYPE I (normal) tape.

- 1 Load a tape.
- 2 Press **DIRECTION** repeatedly to select “**→**” to play one side, “**↔**” to play both sides or “**RELAY**”* (Relay Play) to play both decks in succession.
- 3 Press **<▷**.

The tape starts playing.

Press **<▷** again to play the reverse side.

Tape presence indicator

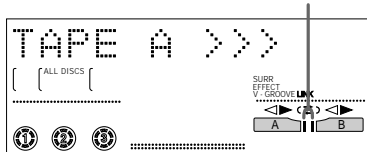

- * Relay Play follows this cyclic sequence:
 Deck A (front side) → Deck A (reverse side) →
 Deck B (front side) → Deck B (reverse side)

To	Do this
Stop playback	Press ■ .
Pause playback	Press . Press again to resume playback.
Fast forward	Press ▶▶ while playing the front side, or press ◀◀ while playing the reverse side. Press <▷ at the point you want to resume playback.
Rewind	Press ◀◀ while playing the front side, or press ▶▶ while playing the reverse side. Press <▷ at the point you want to resume playback.
Remove the tape	Press ⏏ A or ⏏ B.

Tips

- During **↔** or Relay Play, the deck stops automatically after repeating the sequence five times.
- If you press **TAPE A/B** while the power is off, the power turns on automatically and **TAPE** is selected as a function.
- When a tape (tapes) is (are) inserted, corresponding presence indicators light up.

Searching for the beginning of a track (AMS*)

During playback, press **▶▶** or **◀◀** repeatedly for the number of songs you want to skip forward (or backward).

The search direction, + (forward) or - (backward), and the number of songs being skipped (1~9) appear in the display.

Example: searching forward 2 songs

TAPE A >>>+2

* AMS (Automatic Music Sensor)

Note

The AMS function may not operate correctly under the following circumstances:

- When the unrecorded space between songs is less than 4 seconds long.
- When the system is placed near a television.

Recording to a tape

— CD Synchro Recording/Recording Manually/Program Edit

You can record from a whole disc (VIDEO CD, audio CD, MP3 audio tracks), tape, radio or other connected components. The recording level is adjusted automatically.

Steps	Recording from a CD (CD Synchro Recording)	Recording Manually
1	Insert a recordable tape into deck B.	
2	Press DVD.	Press a function button for the recording source.
3	Load the disc you want to record.	Load the disc or tape (or other audio sources), or tune to the station you want to record.
4	Press CD SYNC.	Press REC PAUSE/START.
	Deck B stands by for recording. REC PAUSE/START indicator flashes.	
5	Press DIRECTION repeatedly to select “←→” to record on one side. Select “↔” (or RELAY) to record on both sides.	
6	Press REC PAUSE/START. If you are recording manually, press ◀▶ to start playing the source (for disc or tape). Recording starts.	
7	Press ■ to stop recording.	

Tips

- When you record on both sides, be sure to start from the front side. If you start from the reverse side, recording stops at the end of the reverse side.
- For recording from the reverse side:
After step 1, press TAPE A/B to select deck B and press ◀▶ twice to start playback of the reverse side. Press ■ at the point where you want to start recording. The TAPE B reverse side indicator lights up.
- For recording from the radio:
If noise is heard while recording from the radio, move the respective antenna to reduce the noise.
- For recording from a disc to a tape manually:
You can press ►► or ◀◀ to select tracks during recording pause mode (after step 4 and before step 6).

- You can mix the sound from the component connected to the GAME INPUT jacks with another function such as DVD, tape, radio or MD connected to this system. To record the mixed sound, press GAME MIXING after step 4 of “Recording Manually” and then press REC PAUSE/START to start recording. Game Mixing does not function during CD Synchro Recording.
- When there is severe noise, set “DVD POWER OFF” by DVD power manage function (page 42).

Note

- You cannot listen to other sources while recording.
- CD synchro recording is not available for DVDs and JPEG image file.

Recording a disc by specifying track order

— Program Edit

You can record tracks from all the discs in the order you want. When programming, make sure the playing times for each side do not exceed the length of one side of the tape.

- 1 Insert a recordable tape into deck B, then press DVD.**
- 2 Press PLAY MODE repeatedly until “PGM” lights up in the display.**
- 3 Press DISC SKIP-EXCHANGE (or D.SKIP on the remote) or one of the DISC 1~3 button to select a disc.**

To program all the tracks on a disc at once, proceed to step 5 while “AL” appears in the display.
- 4 Press ►► or ◀◀ repeatedly until the track number you want appears in the display.**

When programming an MP3 audio track, press ALBUM + or – to select album, then press ◀◀ or ►► repeatedly until the track number you want appears.
- 5 Press PUSH ENTER (or ENTER on the remote).**

The track(s) is (are) programmed. The program step number appears.
- 6 To program additional tracks, repeat steps 3 to 5.**

Skip step 3 to select tracks from the same disc.
- 7 Press CD SYNC.**

Deck B standby for recording. The REC PAUSE/START indicator flashes.

- 8 Press DIRECTION repeatedly to select “◄►” to record on one side. Select “◄◄►►” (or RELAY) to record on both sides.**

- 9 Press REC PAUSE/START.**

Recording starts.

To	Do This
Cancel Program Edit	Press PLAY MODE repeatedly until “1 DISC” or “ALL DISCS” lights up in the display.
Clear a track from the end of the program	Press CLEAR on the remote when playback is stopped.

Timer recording radio programs

Tape

To timer-record, you must preset the radio station (see “Presetting radio stations” on page 41) and set the clock (see “Setting the clock” on page 14) beforehand.

- 1 Tune in the preset radio station (see “Listening to the radio” on page 42).**
- 2 Press CLOCK/TIMER SET on the remote.**

“DAILY SET?” appears in the display.
- 3 Press ↑ or ↓ repeatedly to select “REC SET?”, then press PUSH ENTER (or ENTER on the remote).**

“ON” appears and the hour indication flashes in the display.
- 4 Set the time to start recording.**

Press ↑ or ↓ repeatedly to set the hour, then press PUSH ENTER (or ENTER on the remote).

The minute indication starts flashing.

Press ↑ or ↓ repeatedly to set the minute, then press PUSH ENTER (or ENTER on the remote).

continued

45^{GB}

Timer-recording radio programs (continued)

5 Repeat step 4 to set the time to stop recording.

The start time appears, followed by the stop time, the preset radio station to be recorded (e.g., "TUNER FM 5"), then the original display appears.

6 Insert a recordable tape into deck B.

Make sure the tape is in forward direction.

7 Press I/⏻ to turn off the power.

When the recording starts, the volume level is set to the minimum.

To	Do this
Check the setting	Press CLOCK/TIMER SELECT on the remote and press ↑ or ↓ repeatedly to select "REC SELECT?". Then, press PUSH ENTER (or ENTER on the remote).
Change the setting	Start from step 1.
Cancel timer operation	Press CLOCK/TIMER SELECT on the remote and press ↑ or ↓ repeatedly to select "TIMER OFF?". Then, press PUSH ENTER (or ENTER on the remote).

Notes

- You cannot activate the Timer Recording and Daily Timer at the same time.
- If you activate the Timer Recording and the Sleep Timer at the same time, the Sleep Timer has priority.
- If the system is on at the preset time, the Timer Recording and Daily Timer will not be activated.
- The volume is reduced to minimum during Timer Recording.
- Do not operate the system from the time the system turns on until the recording starts (about 15 seconds before the preset time).

Tip

The system turns on 15 seconds before the preset time.

Sound Adjustment

Adjusting the sound



You can reinforce the bass and create a more powerful sound.

Press GROOVE repeatedly.

Each time you press the button, the display changes cyclically as follows:

GROOVE ON → V-GROOVE ON → GROOVE OFF

GROOVE ON

The volume switches to power mode and the equalizer curve changes to suit the music source.

V-GROOVE ON

The volume switches to power mode and the equalizer curve changes to suit the movie source.

Selecting the preset effect



Press **MUSIC EQ**, **MOVIE EQ** or **GAME EQ** repeatedly to select the preset effect you want.

The preset effect name appears in the display. See the chart “Preset effect options”.

To cancel the effect

Press **EFFECT ON/OFF** repeatedly until “EFFECT OFF” appears in the display.

Preset effect options

MENU button	Effect	For
MUSIC EQ	ROCK	standard music sources.
	POP	
	JAZZ	
	DANCE	
	SOUL	
ORIENTAL		
MOVIE EQ	ACTION	soundtracks and special listening situations.
	DRAMA	
	MUSICAL	
GAME EQ	ARCADE	Play station 1, 2 and other video game music sources.
	RACING	
	ADVENTURE	

Selecting the sound field



Press **SOUND FIELD** repeatedly to select the sound field you want.

“**SURR**” lights up in the display when sound field with surround effect is selected.

Each time you press the button, the display changes cyclically as follows:

SBS MULTI¹⁾ → A.F.D. AUTO¹⁾ →
PRO LOGIC¹⁾ → PLII MOVIE¹⁾ →
PLII MUSIC¹⁾ → LINK →
LINK SURR → 2CH SURR → 2CH
STEREO

When the headphone are connected

HP 2CH → HP SURR → HP VIRTUAL¹⁾

¹⁾ These sound fields can be selected during DVD function except when:

- the system is in standby for recording or recording.
- Game Mixing is activated.
- Key Control is activated.
- Karaoke mode is used.
- a microphone is connected.

SBS MULTI (Sound Broadcasting System Multi mode): Performs suitable decoding based on the source to maximize the sound field effect. This mode lets you enjoy audio playback of all types of discs from multiple speakers.

A.F.D. AUTO: Auto Format Decoding (A.F.D.). The number of sound channels is depends on the source, which is recorded on the discs. Playback of 2 channels source such as audio CD, VIDEO CD and MP3 audio tracks would only produce 2 sound channels where as the number of sound channels during DVD's playback is depend on audio format selection. This setting is ideal when you want to listen to the original sound from the source.

PRO LOGIC: Performs Pro Logic decoding. The source recorded in 2 channels is decoded into 4.1 channels.

PLII MOVIE: Performs Pro Logic II Movie mode decoding. This setting is ideal for movie encoded in Dolby Surround. In addition, this mode can reproduce 5.1 channels sound when watching videos of overdubbed or old movies.

PLII MUSIC: Performs Pro Logic II Music mode decoding. This setting is ideal for normal stereo sources such as CDs.

LINK: Reproduces the surround sound channels from the front sound channels output with different output levels.

LINK SURR: Reproduces the surround sound channels from the front sound channels output with different output levels.

2CH STEREO: Reproduces stereo output from multi channel source playback such as DVDs. You should select this mode or 2CH SURR when only front speakers are connected.

2CH SURR: Reproduces stereo output from multi channel source playback such as DVDs with surround effect.

HP 2CH: The normal sound field of headphone.

HP SURR: The headphone sound field with surround effect.

HP VIRTUAL: The headphone sound field with virtual surround effect.

Adjusting the graphic equalizer and storing the personal file



You can adjust the sound by raising or lowering the level of specific frequency band, then store up to three personal files (P FILE) in the memory.

Before adjustment, select the preset effect you want for your basic sound.

- 1 Press **AMP MENU**.
“SPECTRUM” appears on the display.
- 2 Press **↑** or **↓** repeatedly to select “EQ EDIT”, then press **PUSH ENTER** (or **ENTER** on the remote).
Frequency band and frequency level appears.
- 3 Press **←** or **→** repeatedly to select a frequency band, then press **↑** or **↓** repeatedly to adjust the level.

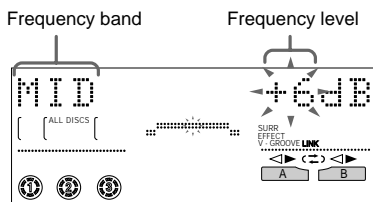

- 4 Press and hold **P FILE** until the personal file number appears in the display.

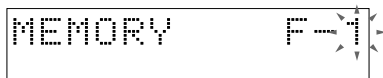

- 5 Press **↑** and **↓** or **←** and **→** repeatedly to select the personal file number where you want to store the equalizer setting.

You can select from “P FILE 1” to “P FILE 3”.

- 6 Press **PUSH ENTER** (or **ENTER** on the remote).

The setting is stored automatically in the personal file number you selected in step 5. The previous setting stored at this memory location is erased and replaced by the new setting.

To call up the personal file Press P FILE repeatedly until the personal file number you want appears in the display.

Tip

If you do not want to store a personal file, press **PUSH ENTER** (or **ENTER** on the remote) after step 3.

Sound Adjustment

Turning off the display

— Power Saving Mode

The demonstration display and the clock display can be turned off to minimize the amount of power consumed during standby mode (Power Saving Mode).

Press DISPLAY repeatedly while the system is turned off until the demonstration display or the clock display disappears.

To cancel Power Saving Mode

Press DISPLAY once to show the demonstration display or twice to show the clock display.

Each time you press the button, the system changes cyclically as follows:

Demonstration¹⁾ → Clock²⁾ → Power Saving Mode

¹⁾ The display changes and the indicators flashes even when the system is turned off.

²⁾ “--:--” appears in the display if you have not set the clock.

Tips

- The  indicator lights up even in Power Saving Mode.
- The timer continues to operate in Power Saving Mode.
- During Power Saving Mode, the following item do not functions:
 - Setting the time.
 - Changing the AM tuning interval (except for Saudi Arabian models).
 - Pressing a function button to turn the power on.
 - Switching the function of MD (VIDEO).
 - Changing “DVD POWER” settings (page 42).
 - Changing the color system.

Changing the spectrum analyzer display

1 Press AMP MENU.

“SPECTRUM” appears in the display.

2 Press PUSH ENTER (or ENTER on the remote).

The last selected spectrum appears.

3 Press ← or → repeatedly to select the setting you want.

The display changes as follows:

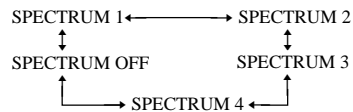

4 Press PUSH ENTER (or ENTER on the remote).

Note

Depending on the audio source and decoding format, the spectrum analyzer may not display during DVD function.

Adjusting the brightness of the display

1 Press AMP MENU.

“SPECTRUM” appears.

2 Press ↑ or ↓ repeatedly to select “DIMMER”, then press PUSH ENTER (or ENTER on the remote).

The last selected dimmer appears.

3 Press ← or → repeatedly to select the setting you want.

The display changes as follows:

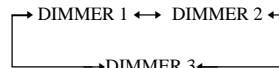

4 Press PUSH ENTER (or ENTER on the remote).

Changing the power illuminator

You can select the power illuminator as you want.

Press ILLUMINATION repeatedly to select the power illuminator you want when the system is turned on.

Each time you press the button, the power illuminator mode changes cyclically as follows:

PATTERN 1 → PATTERN 2 → PATTERN 3 → PATTERN 4 → PATTERN OFF

Notes

- When you turn VOLUME (or press VOL +/- on the remote), power illuminator shows the current volume level.
- During the demonstration display, you can turn on or off power illuminator by pressing ILLUMINATION.
- Depending on the audio source and decoding format, the power illuminator may not display during DVD function.

Viewing information about the disc in the display

You can check the playing time and remaining time of the current track or that of the disc. When a DVD-TEXT or CD-TEXT disc or a disc with MP3 audio tracks or JPEG image files is loaded, you can also check the information recorded on disc, such as the titles. When the system detects DVD-TEXT or CD-TEXT discs, the "DVD TEXT" or "CD TEXT" indication appears in the display.

Checking the playing time, remaining time and titles

Press DISPLAY during playback.

Each time you press the button, the display changes cyclically as follows:

■ When playing a DVD

Playing time of the current title → Remaining time of the current title → Playing time of the current chapter → Remaining time of the current chapter → Disc title¹⁾ → Clock display (for eight seconds) → Effect status → Sound field status → Karaoke effect status⁶⁾

■ When playing an audio CD/VIDEO CD without PBC function

Playing time of the current track → Remaining time of the current track → Playing time of the current disc²⁾ → Remaining time of the current disc²⁾ → Track title³⁾ → Clock display (for eight seconds) → Effect status → Sound field status → Karaoke effect status⁶⁾

■ When playing a VIDEO CD with PBC function (ver 2.0)

Playing time of the current scene⁴⁾ → Clock display (for eight seconds) → Effect status → Sound field status → Karaoke effect status⁶⁾

■ When playing an MP3 audio track

Playing time of the current track → Remaining time of the current track → Track title⁵⁾ → Album title → Clock display (for eight seconds) → Effect status → Sound field status → Karaoke effect status⁶⁾

continued

Display

Viewing information about the disc in the display (continued)

■ When playing a JPEG image file

Current file number → File title → Album title → Clock display (for eight seconds) → Effect status → Sound field status → Karaoke effect status⁶⁾

- ¹⁾ For DVD-TEXT disc only.
- ²⁾ During normal play only.
- ³⁾ For CD-TEXT disc only.
- ⁴⁾ May not appear with still images.
- ⁵⁾ When you playback a track with an ID3 tag version 1.0 or version 1.1, the track title from the ID3 tag is displayed.
- ⁶⁾ When KARAOKE PON, MPX L or MPX R is selected only.

Note

- Only alphabet letters, numbers and some symbol can be display.
- ID3 tag applies only to version 1.0 and 1.1.
- If you play back the MP3 audio track with an ID3 tag, the ID3 tag information is displayed as a track title.
- The ID3 tag character codes comply with ASCII and ISO standards. Joliet format discs can only be displayed in ASCII. Incompatible characters will be displayed as "(space)".
- Playing time and remaining time of the track may not displayed accurately when an MP3 audio track of VBR (variable bit rate) is played.

Checking the total playing time and titles

Press DISPLAY when the playback is stopped.

Each time you press the button, the display changes cyclically as follows:

■ During play modes other than "PGM"

• CD/VIDEO CD

Total number of tracks on the disc and total playing time of the disc → Disc title¹⁾ → Clock display (for eight seconds) → Effect status → Sound field status → Karaoke effect status⁵⁾

• Disc with MP3 audio tracks and JPEG image files

Total number of albums in the disc²⁾ or total number of tracks or files in the selected album³⁾ → Clock display (for eight seconds) → Effect status → Sound field status → Karaoke effect status⁵⁾

• DVD

Total number of titles on the disc → Disc title⁴⁾ → Clock display (for eight seconds) → Effect status → Sound field status → Karaoke effect status⁵⁾

- ¹⁾ For CD-TEXT discs only.
- ²⁾ When the play mode is not "ALBM" or ALBM SHUF".
- ³⁾ When the play mode is "ALBM" or "ALBM SHUF".
- ⁴⁾ For DVD-TEXT discs only.
- ⁵⁾ When KARAOKE PON, MPX L or MPX R is selected.

Depending on the disc, some DVD TEXT or CD TEXT information may not appear.

■ During "PGM" mode

The last track number of the program and total number of programmed step → Disc title¹⁾ → Clock display (for eight seconds) → Effect status → Sound field status → Karaoke status²⁾

- ¹⁾ For discs with CD-TEXT or MP3 audio tracks.
- ²⁾ When KARAOKE PON, MPX L or MPX R is selected only.

Note

Depending on the DVD, the disc information may not be displayed.

Tip

You can check the playing time of the disc using the Control Menu (see "Viewing information about the disc in the on-screen display" on page 53).

Viewing information about the disc in the on-screen display

You can check the playing time and remaining time of the current title, chapter, or track, and the total playing time of the disc.

You can also check the DVD-TEXT, CD-TEXT, disc title, track title, file title and ID3 tag recorded on the disc.

Use buttons on the remote for this operation.

1 Press DVD DISPLAY during playback.

The Control Menu appears.

2 Press **↑** or **↓** repeatedly to select "TIME", then press ENTER.

3 Press DISPLAY repeatedly to change the time information.

The display and the kinds of the time that you can change depend on the disc you are playing.

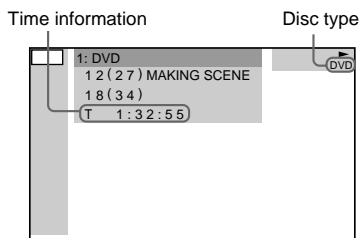

■ When playing a DVD

- T **:**:**
Playing time of the current title
- T_ **:**:**
Remaining time of the current title
- C **:**:**
Playing time of the current chapter
- C_ **:**:**
Remaining time of the current chapter
- **:**:**
Playing time of the menu or current title without a chapter

■ When playing a VIDEO CD (with PBC functions)

- **:**:**
Playing time of the current scene

■ When playing a VIDEO CD (without PBC functions) or audio CD

- T **:**:**
Playing time of the current track
- T_ **:**:**
Remaining time of the current track
- D **:**:**
Playing time of the current disc
- D_ **:**:**
Remaining time of the current disc

■ When playing an MP3 audio track

- T **:**:**
Playing time of the current track
- T_ **:**:**
Remaining time of the current track

To turn off the Control Menu
Press DVD DISPLAY repeatedly until the Control Menu disappears.

Note

- Only alphabet letters, numbers and some symbols can be displayed.
- Depending on the type of disc being played, the system can only display a limited number of characters. Depending on the disc, not all text characters are displayed.

Display

Checking the date information

(JPEG image file only)

You can check the date information during play when Exif* tag is recorded in the JPEG image files.

Use buttons on the remote for this operation.

1 Press DVD DISPLAY during playback.

The Control Menu appears on the on-screen display.

2 Press \uparrow or \downarrow repeatedly to select "DATE", then press ENTER.

Date information

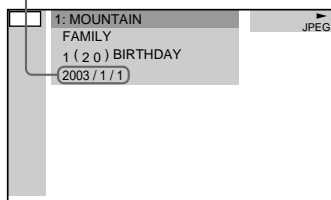

* "Exchangeable Image File Format" is a digital camera image format defined by the Japan Electronics & Information Technology Industries Association.

Note

If there is no date information or data is damaged on the disc, the system cannot display the date information.

Tip

You can change the date display format in "JPEG DATE" of "CUSTOM SETUP" (see page 27).

Enhancing the video game sound

— Game Sync

You need to connect a video game player (see “Hooking up optional components” on page 59).

Press GAME.

“GAME EQ” is selected automatically.

Tip

If you press GAME while the power is off, the power turns on automatically and GAME is selected as the function.

Mixing video game sound with other sound source

— Game Mixing

You can mix the sound from the component connected to the GAME INPUT jacks with another function such as DVD, tape, radio or MD connected to this system.

1 Select the source sound you want.

2 Press GAME MIXING.

Each time you press the button, the level of the game sound changes cyclically as follows:

MIXING LOW → MIXING MID →
MIXING HIGH → MIXING OFF

Tips

- To record the mixed sound, press GAME MIXING after step 4 of “Recording Manually” on page 44 and then press REC PAUSE/START to start recording.
- The GAME MIXING indicator lights up while Game Mixing is activated and it will remain active while the power is on even if the function is changed.

Notes

- When GAME MIXING is activated, video signal from the video game player connected to the GAME INPUT jacks will only be output from the system’s VIDEO OUT jacks. Therefore, to view game images, connect the system and your TV using only the supplied video cable. You will view video images from DVD if you make S Video or component video connections.
- Game Mixing is cancelled when you press REC PAUSE/START.
- Game Mixing does not function during CD Synchro Recording.

Singing along: Karaoke

You can sing along with any multiplex VIDEO CD or audio CD. You can also output either the left or right channel sound from both speakers while playing a stereo CD or VIDEO CD. Note that this results in monaural sound. For example, when playing a Karaoke VIDEO CD (disc with the vocals on one channel and the instruments on the other channel), you can switch the sound to cancel the vocal track and listen only to the instruments from both speakers. You cannot change the sound of MP3 audio tracks. You need to connect an optional microphone.

1 Turn MIC LEVEL to MIN to turn down the microphone volume.

2 Connect an optional microphone to MIC jack.

3 Press KARAOKE/MPX.

Each time you press the button, the display changes cyclically as follows:

KARAOKE PON → MPX L* → MPX R*
→ KARAOKE OFF

To sing karaoke of multiplex audio CD or VIDEO CD, select “MPX L” or “MPX R”.

The “” indicator appears in the display when a karaoke mode is activated.

To sing karaoke by decreasing the vocal level of the music source, select “KARAOKE PON”.

* You cannot select MPX L and MPX R during DVD playback.

continued

Singing along: Karaoke (continued)

4 Start playing the music and adjust the volume.

5 Adjust the microphone volume by turning MIC LEVEL.

To	Do this
Use VIDEO CDs or DVDs	Turn on your TV and select the video input.
Cancel karaoke mode	Turn MIC LEVEL to MIN, disconnect the microphone from MIC jack, then press KARAOKE/MPX repeatedly until “  ” disappears.
Adjust the microphone echo	Turn ECHO LEVEL to adjust the echo effect. To cancel the echo effect, turn ECHO LEVEL to MIN.
Adjust the key (Except JPEG image file)	Press KEY CONTROL # or b on the remote to suit your vocal range. You can adjust the key higher or lower in 13 half-tone steps (b6 ~ #6).

Notes

- With some songs, vocals may not be canceled when you select “KARAOKE PON”.
- The instrumental sound may be reduced as well as the singer’s voice when the sound is recorded in monaural.
- If you connect the microphone while playing a 5.1 channel, the sound switches to 2 channel.
- If the disc changes, karaoke mode is canceled.
- Karaoke can be used during DVD function only.
- The singer’s voice may not be reduced when:
 - only a few instruments are playing.
 - a duet is being played.
 - the source has strong echoes or chorus.
 - the singer’s voice deviates from the center.
 - the voice on the source is singing in high soprano or tenor.

Tip

You cannot select KARAOKE PON, MPX L or MPX R for discs with JPEG image files.

Mixing and recording sounds

You can “mix” sounds by playing one of the components and singing or speaking into a microphone.

The mixed sound can be recorded on a tape.



1 Do the procedure for singing along (steps 1 to 5 on page 55). Then, insert a recordable tape in deck B.

2 Press the function button of the source you want to record (e.g., DVD).

If you want to record from TAPE A, press TAPE A/B repeatedly until TAPE A is selected.

3 Press REC PAUSE/START.

Deck B standby for recording. The REC PAUSE/START button flashes.

4 Press DIRECTION repeatedly to select  to record on one side. Select  (or RELAY) to record on both sides.

5 Press REC PAUSE/START.

Recording starts.

6 Press  to start playing the source to be recorded.

Start singing along with the music.

After you have finished.

Turn MIC LEVEL to MIN and disconnect the microphone from MIC jack.

Tips

- You can mix and record sound from microphone after step 2. To record the sound see “Recording Manually” on page 44. To stop recording, press .
- If acoustic feedback (howling) occurs, move the microphone away from the speakers or change the direction of the microphone.
- If you want to record your voice through the microphone only, you can do so by selecting the DVD function and not playing a disc.
- When high level sound signals are input, the system automatically adjust the recording level to prevent distortion of the recorded sound signals (Auto Level Control Function).

Falling asleep to music

— Sleep Timer

You need to use the remote to activate the Sleep Timer. You can set the system to turn off at a preset time, so you can fall asleep to the music.

Press SLEEP.

Each time you press the button, the minute display (the turn-off time) changes cyclically as follows:

AUTO* → 90 → 80 → 70 → ... → 10 → OFF

* The system turns off when the current disc or tape finishes playback (for up to 100 minutes).

To	Do this
Check the remaining time**	Press SLEEP once.
Change the time to turn off	Press SLEEP repeatedly to select the time you want.
Cancel the Sleep Timer	Press SLEEP repeatedly until "SLEEP OFF" appears in the display.

** You cannot check the remaining time when you select "SLEEP AUTO".

Note

Do not set to "SLEEP AUTO" during CD Synchro Recording on a tape.

Tip

You can use the Sleep Timer, even you have not set the clock.

Waking up to music

— Daily Timer

You can wake up to music at a preset time every day. Make sure you have set the clock (see "Setting the clock" on page 14).

1 Prepare the music source you want to play.

- DVD: Load a disc. To start from a specific track, make a program (see "Creating your own program" on page 22).
- Tape: Load a tape with the side you want to play facing forward.
- Radio: Tune in the preset station you want (see "Listening to the radio" on page 42).

2 Adjust the volume.

3 Press CLOCK/TIMER SET on the remote.

"DAILY SET?" appears in the display.

4 Press PUSH ENTER (or ENTER on the remote).

"ON" appears and the hour digits flash in the display.

5 Set the time to start playback.

Press ↑ or ↓ repeatedly to set the hour, then press PUSH ENTER (or ENTER on the remote).

The minute indication flashes.

Press ↑ or ↓ repeatedly to set the minute, then press PUSH ENTER (or ENTER on the remote).

6 Set the time to stop playback following step 5 above.

7 Press ↑ or ↓ repeatedly until the music source you want appears.

The display changes as follows:

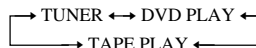

continued

Waking up to music (continued)

8 Press PUSH ENTER (or ENTER on the remote).

The type of timer, followed by the start time, stop time and the music source appears, then the original display appears.

9 Press I/⏻ to turn off the system.

Other Operations

To	Do this
Check the setting	Press CLOCK/TIMER SELECT on the remote and press ↑ or ↓ repeatedly to select "DAILY SELECT?"; then press PUSH ENTER (or ENTER on the remote).
Change the setting	Start from step 1.
Cancel the timer operation	Press CLOCK/TIMER SELECT on the remote and press ↑ or ↓ repeatedly to select "TIMER OFF?"; then press PUSH ENTER (or ENTER on the remote).

Notes

- You cannot activate the Daily Timer and Timer Recording at the same time.
- If you use the Daily Timer and the Sleep Timer at the same time, the Sleep Timer has priority.
- If the system is on at the preset time, the Daily Timer will not be activated.

Tip

The systems turns on 15 seconds before the preset time.

Hooking up optional components

To enhance your system, you can connect optional components. Refer to the operating instructions provided with each component.

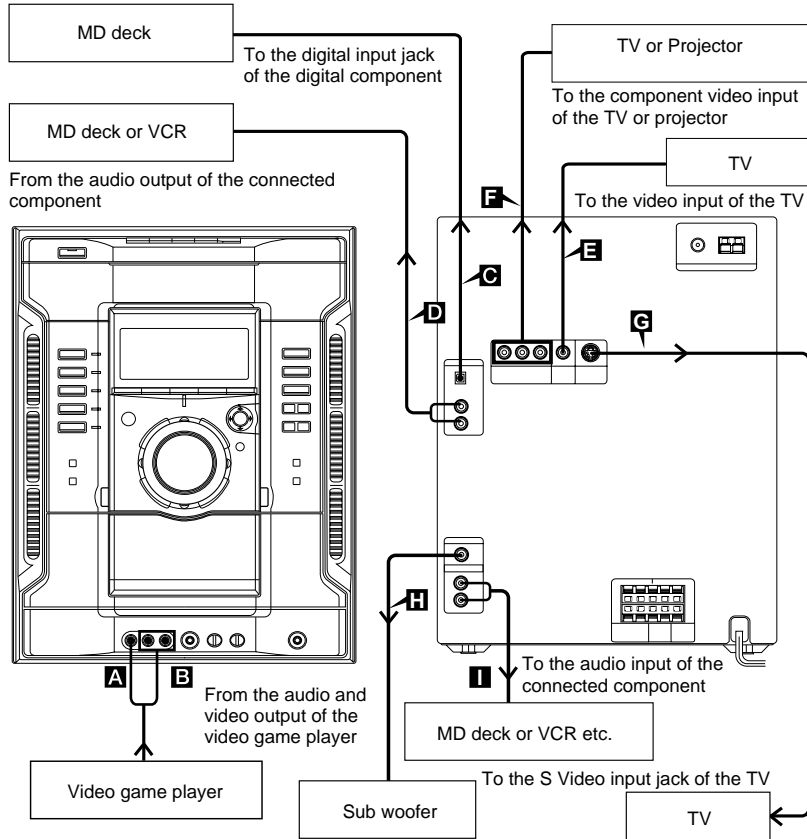

- A GAME INPUT VIDEO jack**
Use a video cable (not supplied) to connect the video output of the optional video game player to this jack.
- B GAME INPUT AUDIO jacks**
Use audio cords (not supplied) to connect the audio output of the optional video game player to these jacks. You can then output audio through this system. To listen to the analog sound of connected video game, press GAME.

- Notes**
- To enjoy video game sound, see “Enhancing the video game sound” on page 55, or see “Selecting the preset effect” on page 47 for video game sound effects.
 - The video game machine image may appear on the TV screen even if the system is turned off.
 - If you press GAME while the system is off, the system turns on, the function switches to GAME, and the equalizer also switches to the GAME EQ (previously selected effect).
 - If you press GAME while the system is on, the function switches to GAME and the equalizer automatically switches to the GAME EQ (previously selected effect).

continued

Hooking up optional components (continued)

C DVD DIGITAL OUT jack

Use a digital optical cable (square, not supplied) to connect the digital input of the optional MD deck or amplifier to this jack. You can then record digital audio from this system.

Note

There is no digital audio output from this jack during playback of a DVD, VIDEO CD or MP3 audio tracks.

D MD/VIDEO (AUDIO) IN jacks

Use audio cords (not supplied) to connect the audio output of the optional component (such as MD deck or VCR) to these jacks. You can then output audio through this system.

E VIDEO OUT jack

Use a supplied video cable to connect the video input of TV to this jack.

F COMPONENT VIDEO OUT jack

Use the optional video cable (not supplied) to connect component video input of the TV to these jacks. If your TV accept progressive format file signals, you must use this connection and set "COMPONENT OUT" to "PROGRESSIVE" in "Adjusting the TV screen" (page 30).

Note

You cannot output the video signal from GAME INPUT VIDEO jack through COMPONENT VIDEO OUT and S VIDEO OUT jacks of this system.

G S VIDEO OUT jacks

Use an S video cord (not supplied) to connects video input of the TV to this jack. You can enjoy higher quality video images.

Note

You cannot output the video signal from GAME INPUT VIDEO jack through COMPONENT VIDEO OUT and S VIDEO OUT jacks of this system.

H SUBWOOFER OUT jack

Use an audio cord (not supplied) to connect an optional sub woofer* to this jack.

* SA-GN1 is recommended.

In some areas, the SA-GN1 may not yet be available.



Note

The effect may be limited or noise may occur depending on the connected sub woofer or the type of music being played. For details, consult your nearest Sony dealer.

I AUDIO OUT jack

Use audio cord (not supplied) to connect the audio input of the optional component such as MD deck or VCR to this jack.

Listening to audio from a connected component

To	Do This
Listen to a connected MD deck	<ol style="list-style-type: none"> 1 Connect the audio cords. See "Hooking up optional components" on page 59. 2 Press MD (VIDEO). Start playing the connected MD deck.
Listen to a connected VCR	<ol style="list-style-type: none"> 1 Connect the audio cords. See "Hooking up optional components" on page 59. 2 Hold down MD (VIDEO) on the system and press  on the system while the power is on. Release  first, then release MD (VIDEO). This switches the function from MD to VIDEO. Start playing the connected VCR.
Listen to the sound of a connected video game player	<ol style="list-style-type: none"> 1 Press GAME. 2 Select the preset effect. See "Selecting the preset effect" on page 47.

Notes

- If you press MD (VIDEO) while the power is off, the power turns on automatically and MD (VIDEO) is selected as the function.
- If the sound is distorted or too loud when VIDEO function is selected, or you want to switch back to MD function, repeat step 2 of "Listen to a connected VCR".

Recording on a connected component

To	Do This
Make a digital recording from an audio CD onto a connected MD deck	<ol style="list-style-type: none"> 1 Connect the optional optical cable from DVD DIGITAL OUT jack to digital audio input MD deck. 2 Start recording. Refer to operating instructions provided with the connected MD deck.
Make an analog recording from DVD, TAPE or TUNER onto a connected MD deck	<ol style="list-style-type: none"> 1 Connect an optional audio cord from AUDIO OUT jacks to the audio input of the MD deck. See "Hooking up optional components" on page 59. 2 Start recording. Refer to the operating instruction provided with connected component.
Record the audio and video signals from a VIDEO CD onto a video tape	<ol style="list-style-type: none"> 1 Connect an optional audio cords from AUDIO OUT jack and the supplied video cable from the VIDEO OUT jack to the audio and video input of your VCR. 2 Start recording. Refer to the operating instruction provided with connected component.

Tip
When you remove the optical cover, keep it for future use.

Note
You cannot record from a VIDEO CD, an MP3 audio track or a DVD digitally. When you record from a VIDEO CD, an MP3 audio track or DVD to a connected MD deck, make an analog recording on MD.

Connecting external antennas

Connect an external antenna to improve the reception.

FM antenna

Connect an optional FM external antenna. You can also use the TV antenna instead.

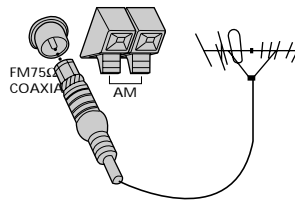

AM antenna

Connect a 6 to 15 meter (20 to 50 feet) insulated wire to the AM antenna terminal. Leave the supplied AM loop antenna connected.

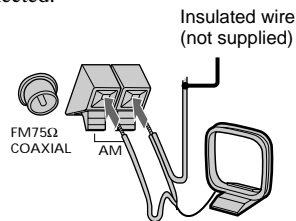

Optional Components

Problems and remedies

If you run into any problem using this system, use the following check list. First, check that the power cord is connected firmly and the speakers are connected correctly and firmly. Should any problem persist, consult your nearest Sony dealer.

When the I/⏻ indicator flashes

Immediately unplug the power cord and check the following items.

- Are the + and – speaker cords short circuited?
- Are you using only the prescribed speakers?
- Is anything blocking the ventilation holes on the rear of the system?

After checking the above items and fixing any problems, connect the power cord again and turn on the system. If the indicator still flashes, or if the cause of the problem cannot be found even after checking all the above items, consult your nearest Sony dealer.

General

The display starts flashing as soon as you plug in the power cord even though you haven't turned on the power.

- The demonstration mode started. Press I/⏻ (see step 7 on page 12).

The clock/timer setting is cancelled.

- The power cord is disconnected or a power failure occurs. Redo "Setting the clock" (on page 14). If you have set the timer, redo "Waking up to music" (on page 57) and "Timer-recording radio programs" (on page 45).

The radio presetting is canceled.

- The power cord is disconnected or a power failure occurs for longer than half a day. Redo "Presetting radio stations" (on page 41).

There is no sound.

- Turn VOLUME clockwise.
- The headphones are connected to the PHONES jack.
- Insert only the stripped portion of the speaker cord into the SPEAKER terminal. Inserting the vinyl portion of the speaker cord will obstruct the speaker connections.
- There is no audio output during Timer Recording.
- The system is in pause mode, in slow motion play or in lock search. Press ◀▶ to return to normal play mode.

There is severe hum or noise.

- A TV or VCR is placed too close to the system. Move the system away from the TV or VCR.

The sound from the component connected to the MD/VIDEO (AUDIO) jacks is distorted.

- If "VIDEO" appears in the display when you press MD (VIDEO), switch to "MD" function (see "Listen to audio from a connected component" on page 60).

"-- --" appears in the display.

- A power failure occurred. Set the clock and timer settings again.

The timer can not be set.

- Set the clock again (page 14).

The timer does not function.

- Set the clock correctly.
- You cannot activate the Daily timer and Timer Recording simultaneously.

"DAILY SET?" and "REC SET?" do not appear when you press the CLOCK/TIMER SET button on the remote.

- Set the timer correctly.
- Set the clock.

The remote does not function.

- There is an obstacle between the remote and the system.
- The remote is not pointing in the direction of the system's sensor.
- The batteries have run down. Replace the batteries.

There is acoustic feedback.

- Decrease the volume level.
- Move the microphone away from the speakers or change the direction of the microphone.

The color irregularity on a TV screen persists.

- Turn off the TV set once, then turn it on after 15 to 30 minutes. If the color irregularity still persists, place the speakers farther away from the TV set.
-

Speakers

Sound comes from only one channel or unbalanced left and right volume.

- Check the speaker connection and speaker placement.
-

The sound comes from the center speaker only.

- Depending on the disc, the sound may come from the center speaker only.
-

There is no sound from the sub woofer.

- No sound is produced from the sub woofer when you play a DVD that does not have sub woofer output recorded.
 - Make sure that the SUBWOOFER setting is set to "YES" (page 36).
-

There is no sound from the center speaker.

- Set the center speaker level to the appropriate level.
 - The software being played back has limited sound effects. Check the volume with the test tone.
-

Sound lacks bass.

- Check that the speaker's + and – terminals are connected correctly.
-

DVD/VIDEO CD/CD/MP3/JPEG Player

The disc tray does not open and "LOCKED" appears on the display.

- Contact your Sony dealer or local authorized Sony service facility.
-



"MECHA LOCK" appears on the display.

- Turn off the system and unplug AC power cord. Then, connect the AC power cord again.
-



The disc tray does not close.

- The disc is not placed properly.
 - Always close the tray by pressing OPEN/CLOSE  on the system. Trying to press the tray closed with your fingers may cause problems with the system.
-

The disc does not eject.

- You cannot eject the disc during CD Synchro Recording. Press  to cancel the CD Synchro Recording, then press OPEN/CLOSE  on the system to eject the disc.
 - Consult your nearest Sony dealer.
-

Play does not start.

- Open the disc tray and check whether a disc is loaded.
 - Wipe the disc clean (page 69).
 - Replace the disc.
 - Place the disc that this system can play (page 6).
 - Place the disc correctly.
 - Place the disc in the tray with the label side up.
 - Remove the disc and wipe away the moisture on the disc, then leave the system turned on for a few hours until the moisture evaporates.
 - Press   to start play.
 - The region code on the DVD does not match the system.
 - Cancel the Custom Parental Control function (page 32).
-

Disc access takes a longer time.

- Set "DVD POWER ON" by DVD power manage function (page 42).
-

Audio signal drops when making an analog recording to a connected optional component through AUDIO OUT jacks.

- Audio signal may be intermittently output from AUDIO OUT jacks while recording if the followings are done.
 - SOUND FIELD is pressed.
 - the headphones are connected or disconnected.
 - a microphone is connected or disconnected.
-

The recording is not done properly when making a digital recording from the audio CD to a connected MD deck through DVD DIGITAL OUT jacks.

- Digital audio data is output from the DVD DIGITAL OUT jack without any surround effects or other sound processing, so that the audio data is output slightly ahead from the sound from the speakers. Therefore, start the connected MD deck recording in advance when making a digital recording to a connected MD deck.
-

continued

Problems and remedies (continued)

The sound skips.

- Wipe the disc clean (page 69).
 - Replace the disc.
 - Try moving the system to a place without vibration (e.g., on top of a stable stand).
 - Try moving the speakers away from the system, or placing them on separate stands. When you listen to a track with bass sounds at high volume, the speaker vibration may cause the sound to skip.
-

Play does not start from the first track.

- Press PLAY MODE repeatedly until “ALL DISCS” and “1 DISC” appears in the display.
 - Resume Play has been selected. Press ■ in stop mode, then start playback (page 16).
 - The title, DVD or PBC menu automatically appears on the screen.
-

Playback starts automatically.

- The DVD features an auto playback function.
-

Playback stops automatically.

- Some discs may contain an auto pause signal. While playing such a disc, the playback stops at auto pause signal.
-

The system turned off during DVD playback.

- If the system is set in DVD pause mode, DVD top menu or DVD menu for approximately 1 hour, the system would turned off automatically.
-

You cannot perform some function such as Stop, Search, Slow-motion Play, Repeat Play, Shuffle Play, or Program Play.

- Depending on the disc, you may not be able to do some of the operations above. Refer to the operating instructions supplied with the disc.
-

MP3 audio track cannot be played back.

- Recording was not performed according to the ISO9660 level 1, level 2, or Joliet in the expansion format.
 - The MP3 audio track does not have the extension “.MP3”.
 - The data is not stored in MP3 format even though it has extension “.MP3”.
 - The discs containing tracks other than MPEG 1 Audio Layer 3 files cannot be played back.
 - The system can play to a depth of 8 directories.
-

MP3 audio tracks take a longer time to playback than others.

- After the system reads all tracks on the disc, playback may take more time than usual if
 - the number of albums or tracks on the disc is very large.
 - the album and track organization structure is very complex.
-

The JPEG image file cannot be played.

- The data CD is not recorded in JPEG format that conforms to ISO 9660 level 1, level 2 or Joliet in expansion format.
 - The JPEG image file does not have the extension “.JPG” or “.JPEG”.
 - The data is not stored in JPEG format even though it has extension “.JPG” or “.JPEG”.
 - Length or width of image is more than 4720 dots.
 - Remove the disc and select “CUSTOM SETUP” from the setup items. Then select “DATA CD PRIORITY” and set to “JPEG” again (page 29).
 - The JPEG image files in progressive format is not supported.
 - The system can play to a depth of 8 directories.
-

The disc title, album title, track title, ID3 tag, DVD-TEXT and the CD-TEXT characters do not appear properly.

- Use a disc that conforms with ISO 9660 level 1, level 2, or Joliet in the expansion format.
 - The ID3 tag is not version 1.
 - The character code that can be displayed by this system are as follows.
 - Upper cases (A to Z)
 - Lower cases (a to z)
 - Numbers (0 to 9)
 - Symbols (<> * +, - / [] \ _)Other characters may not be displayed correctly.
-

The sound effect is difficult to hear when you are playing a Dolby Digital or MPEG sound track.

- Make sure the sound field is set properly (page 48).
- Check the speaker connections and settings (pages 10 and 36).
- Depending on the DVD, the output signal may not be the entire 5.1 channel. It may be monaural or stereo, even if the sound track is recorded in Dolby Digital or MPEG audio format.

The sound loses stereo effect when you play an audio CD, VIDEO CD, MP3 audio tracks or DVD.

- Select "KARAOKE OFF".
- Make sure the system is connected properly.

Picture

There is no picture.

- Press DVD on the system.
- Check that the system is connected securely.
- The video cable is damaged. Replace it with a new one.
- Make sure you connect the system to the video input jack of your TV (page 11).
- Make sure you turn on the TV and operate the TV correctly.
- You have set "COMPONENT OUT" in "SCREEN SETUP" to "PROGRESSIVE" even though your TV cannot accept the signal in progressive format. In this case, press ■ and DVD MENU on the system simultaneously (see page 31).
- Make sure you select the video input on the TV so that you can view the pictures from the system.
- Make sure you set the color system correctly, according to your TV color system.
- Make sure Game Mixing is cancelled.
- Make sure you connect the system and your TV using only the supplied video cable.

Picture noise appears.

- Clean the disc.
- If video signal from your system has to go through your VCR to your TV, the copy-protection applied to some DVD programs could affect picture quality. If you still experience problems after checking your connections, please try to connect your system directly to your TV's S Video input (page 11).
- Set the color system to match your TV (page 31).

The aspect ratio of the TV screen cannot be changed even though you can set "TV TYPE" in "SCREEN SETUP" in the Setup Menu when you play a wide picture.

- The aspect ratio is fixed on your DVD.
- If you connect the system with the S Video cable, connect directly to the TV. Otherwise, you may not change the aspect ratio.
- Depending on the TV, you may not change the aspect ratio.

Messages do not appear on the TV screen in the language you want.

- Select the language you want for the on-screen display in "OSD" under "LANGUAGE SETUP" in the Setup Menu (page 40).

The language for the sound track cannot be changed.

- Multilingual tracks are not recorded on the DVD being played.
- The DVD prohibits changing the language for the sound track.

The subtitles language cannot be changed.

- Multilingual subtitles are not recorded on the DVD being played.
- The DVD prohibits changing the subtitles.

The subtitle's cannot be turned off.

- The DVD prohibits turning off subtitles.

The angles cannot be changed.

- Multi-angles are not recorded on the DVD being played.
- The DVD prohibits changing the angles.

continued

Problems and remedies (continued)

Tape Deck

The tape does not record.

- The tab has been removed from the tape. Cover the broken tab with adhesive tape.
- The tape has reeled to the end.

The tape does not record nor play or there is a decrease in sound level.

- The tape heads are dirty. (See “Cleaning the tape heads” on page 69).
- The record/playback heads are magnetized. (See “Demagnetizing the tape heads” on page 69).

The tape does not erase completely.

- The record/playback heads are magnetized. (See “Demagnetizing the tape heads” on page 69).

There is excessive wow or flutter, or the sound drops out.

- The capstans or pinch rollers are dirty. (See “Cleaning the tape heads” on page 69).

Noise increases or the high frequencies are erased.

- The record/playback heads are magnetized. (See “Demagnetizing the tape heads” on page 69).

Tuner

There is severe hum or noise (“TUNED” or “STEREO” flashes in the display).

- Set the proper band and frequency (page 41).
- Connect the antenna properly (page 11).
- Find a place and an orientation that provide good reception, then set up the antenna again. If you cannot obtain good reception, we recommend you connect a commercially available antenna.
- The supplied FM lead antenna receives signals along its entire length, so make sure you extend it fully.
- Locate the antennas as far away from the speaker cord as possible.
- Try turning off surrounding electrical equipment.
- Set “DVD POWER OFF” by DVD power manage function (page 42).

A stereo FM program cannot be received in stereo.

- Press FM MODE so that “MONO” disappears.

Optional components

There is no sound.

- Refer to General item “There is no sound.” (page 62) and check the condition of the system.
- Connect the component properly (page 59) while checking:
 - if the cords are connected properly.
 - if the cord plugs are firmly inserted all the way.
- Turn on the connected component.
- Refer to the operating instructions supplied with the connected component and start playing.

If the system still does not operate properly after performing the above measures or other troubles does not described above occur, reset the system as follows:

Use the buttons on the system for this operation.

- 1 Unplug the power cord.
- 2 Plug the power cord back in.
- 3 Press **■**, **AMP MENU** and **I/⏻** at the same time.
- 4 Press **I/⏻** to turn on the system.

The system is reset to factory settings. All the settings are cleared.

The system is reset to the factory settings except for DVD settings. You should set the settings you made, such as the preset stations, clock and timer.

To return the DVD setup to the default settings, perform reset as follows:

1 Press DVD SETUP on the remote in stop mode.

The Setup Menu appears on the on-screen display.

2 Press ↑ or ↓ repeatedly to select “RESET”, then press PUSH ENTER (or ENTER on the remote).

3 Press ↑ or ↓ repeatedly to select “YES”, then press PUSH ENTER (or ENTER on the remote).

It takes a few seconds to complete. Do not press I/⏪ when resetting the system.

Note

Turn off the sub woofer before you reset the system.

Messages

One of the following messages may appear or flash in the display during operation.

DVD/VIDEO CD/CD/MP3/JPEG

Cannot Play

- A disc that cannot be played was inserted.
- A disc with an unsupported Region code was inserted.

No Disc

- There is no disc on the disc tray.

Push STOP!

- You pressed PLAY MODE or DVD SETUP during playback.

Step Full!

- You tried to program 26 or more tracks (steps).

Reading

- The system is reading information of the disc. Some buttons are not available.

Please Wait

- The system is doing initialization process.

Play Limit

- You tried to playback an MP3 audio track whose format is not supported by this system.

Data Error

- You tried to playback a JPEG image file whose format is not supported by this system.

Not in Use

- You pressed an invalid button.

TAPE

No Tab

- You cannot record the tape because the tab has been removed from the tape.

No Tape

- There is no tape in the tape deck.

TIMER

OFF TIME NG!

- The on time and off time of Daily Timer or Timer Recording is same.

SET CLOCK!

- You pressed CLOCK/TIMER SELECT before the clock is set.

SET TIMER!

- You pressed CLOCK/TIMER SELECT before Daily Timer or Timer Recording is set.

Additional Information

Precautions

On operating voltage

Before operating the system, check that the operating voltage of your system is identical with the voltage of your local power supply.

On safety

- The system is not disconnected from the AC power source (mains) as long as it is connected to the wall outlet, even if the system itself has been turned off.
- Unplug the system from the wall outlet (mains) if it is not to be used for an extended period of time. To disconnect the cord (mains lead), pull it out by the plug. Never pull the cord itself.
- Should any solid object or liquid fall into the component, unplug the system and have the component checked by qualified personnel before operating it any further.
- The AC power cord must be changed only at the qualified service shop.

On placement

- Do not place the system in an inclined position.
- Do not place the system in locations where it is:
 - extremely hot or cold
 - dusty or dirty
 - very humid
 - vibrating
 - subject to direct sunlight
- Use caution when placing the system or speakers on surfaces that have been specially treated (with wax, oil, polish, etc.) as staining or discoloration of the surface may result.

On heat build-up

- Although the system heats up during operation, this is not a malfunction.
- Place the system in a location with adequate ventilation to prevent heat build-up in the system.

If you use this system at a large volume, the cabinet temperature of the top, side and bottom rises considerably. To avoid burning yourself, do not touch the cabinet.

To prevent a malfunction, do not cover the ventilation hole for the cooling fan.

If you have any questions or problems concerning your system, please consult your nearest Sony dealer.

In case color irregularity is observed on a nearby TV screen

With the magnetically shielded type of speaker system, the speakers can be installed near a TV set. However, color irregularity may still be observed on the TV screen depending on the type of your TV set.

If color irregularity is observed...

Turn off the TV set once, then turn it on after 15 to 30 minutes.

If color irregularity is observed again...

Place the speakers farther away from the TV set.

IMPORTANT NOTICE

Caution: This system is capable of holding a still video image or on-screen display image on your television screen indefinitely. If you leave the still video image or on-screen display image displayed on your TV for an extended period of time you risk permanent damage to your television screen. Projection televisions are especially susceptible to this.

On operation

- If the system is brought directly from a cold to a warm location, or is placed in a very damp room, moisture may condense on the lens inside the system. Should this occur, the system will not operate properly. Remove any disc and leave the system turned on for about an hour until the moisture evaporates.
- When you move the system, take out any disc.

Notes on discs

- Before playing, clean the disc with a cleaning cloth. Wipe the disc from the center out.
- Do not use solvents such as benzene, thinner, commercially available cleaners or anti-static spray intended for vinyl LPs.
- Do not expose the disc to direct sunlight or heat sources such as hot air dusts nor leave it in a car parked in direct sunlight.
- Do not use disc encircled with a protection ring. This may cause a malfunction to the system.
- When using disc that have glue or similiar tacky substance on the label side of the disc or that used a special ink when the label was printed, there is a chance that the disc or label may become attached to parts inside this system. When this occurs, it may not be possible to remove the disc, and may also cause this system to malfunction. Be sure to check that the label side of the disc is not sticky before using.
The following types of disc should not be used:
 - Rental or used discs with attached seals where the glue extends beyond the seal. The perimeter of the seal on the disc is tacky.
 - Discs that have labels printed using a special ink that feels tacky when touched.
- Discs with non-standard shapes (e.g., heart, square, star) cannot be played on this system. Attempting to do so may damage the system. Do not use such discs.

Cleaning the cabinet

Use a soft cloth slightly moistened with mild detergent solution.

To save a tape permanently

To prevent a tape from being accidentally recorded over, break off the tape tab. Refer to the instructions of the tape.

Before placing a tape in the tape deck

Take up any slack in the tape deck. Otherwise the tape may get entangled in the parts of the tape deck and become damaged.

When using a tape longer than 90 minutes

The tape is very elastic. Do not change the tape operations such as play, stop, and fast-winding etc. frequently. The tape may get entangled in the tape deck.

Cleaning the tape heads

Clean the tape heads after every 10 hours of use. Make sure to clean the tape heads before you start an important recording or after playing an old tape. Use separately sold dry-type or wet-type cleaning cassette. For details, refer to the instructions of the cleaning cassette.

Demagnetizing the tape heads

Demagnetize the tape heads and the metal parts that have contact with the tape every 20 to 30 hours of use with a separately sold demagnetizing cassette. For details, refer to the instructions of the demagnetizing cassette.

Specifications

Amplifier section

MHC-GN88D

The following are measured at AC 220V 50/60 Hz
DIN power output (rated)

Front speaker:	185 + 185 watts (6 ohms at 1 kHz, DIN)
Center speaker:	50 watts (8 ohms at 1 kHz, DIN)
Surround speaker:	50 + 50 watts (8 ohms at 1 kHz, DIN)

Continuous RMS power output (reference)

Front speaker:	235 + 235 watts (6 ohms at 1 kHz, 10% THD)
Center speaker:	70 watts (8 ohms at 1 kHz, 10% THD)
Surround speaker:	70 + 70 watts (8 ohms at 1 kHz, 10% THD)

MHC-GN77D

The following are measured at AC 220V 50/60 Hz
DIN power output (rated)

Front speaker:	110 + 110 watts (6 ohms at 1 kHz, DIN)
Center speaker:	30 watts (8 ohms at 1 kHz, DIN)
Surround speaker:	30 + 30 watts (8 ohms at 1 kHz, DIN)

Continuous RMS power output (reference)

Front speaker:	150 + 150 watts (6 ohms at 1 kHz, 10% THD)
Center speaker:	40 watts (8 ohms at 1 kHz, 10% THD)
Surround speaker:	40 + 40 watts (8 ohms at 1 kHz, 10% THD)

Inputs

GAME (VIDEO): (phono jack)	1 Vp-p, 75 ohms
GAME (AUDIO): (phono jacks)	Voltage 250 mV, impedance 47 kilohms
MD/VIDEO (AUDIO) IN: (phono jacks)	voltage 450 mV/250 mV, impedance 47 kilohms
MIC: (phone jack)	sensitivity 1 mV, impedance 10 kilohms

Outputs

AUDIO OUT: (phono jacks)	Voltage 250 mV impedance 1 kilohms
VIDEO OUT: (phono jack)	max. output level 1 Vp-p, unbalanced, Sync. negative load impedance 75 ohms

COMPONENT VIDEO OUT:

Y: 1 Vp-p, 75 ohms
PB/CB: 0.7 Vp-p, 75 ohms
Pr/Cr: 0.7 Vp-p, 75 ohms

S VIDEO OUT

(4-pin/mini-DIN jack):	Y: 1 Vp-p, unbalanced, Sync negative C: 0.286 Vp-p load impedance 75 ohms
------------------------	--

PHONES:

(stereo mini jack)	accepts headphones of 8 ohms or more
FRONT SPEAKER:	accepts impedance of 6 to 16 ohms

SUBWOOFER OUT:

(phono jack)	Voltage 250 mV impedance 1 kilohms
SURROUND SPEAKER:	accepts impedance of 8 ohms to 16 ohms

CENTER SPEAKER:

accept impedance of 8 ohms to 16 ohms
--

Disc player section

Laser	Semiconductor laser (DVD: $\lambda = 650$ nm, CD: $\lambda = 780$ nm) Emission duration: continuous
Frequency response	DVD (PCM 48 kHz): 2 Hz – 22 kHz = (± 1 dB) CD: 2 Hz – 20 kHz (± 0.5 dB)
Video color system format	NTSC, PAL (except Latin American models)
DVD DIGITAL OUT (OPTICAL)	(Square optical connector jack, rear panel)
Wave length	660 nm

Tape player section

Recording system	4-track 2-channel stereo
Frequency response	50 – 13,000 Hz (± 3 dB), using Sony TYPE I cassette
Wow and flutter	$\pm 0.15\%$ W.Peak (IEC) 0.1% W.RMS (NAB) $\pm 0.2\%$ W.Peak (DIN)

Tuner section

FM stereo, FM/AM superheterodyne tuner

FM tuner section

Tuning range	87.5 – 108.0 MHz
Antenna	FM lead antenna
Antenna terminals	75 ohm unbalanced
Intermediate frequency	10.7 MHz

AM tuner section

Tuning range	531 – 1,602 kHz (with the interval set at 9 kHz) 530 – 1,710 kHz (with the interval set at 10 kHz)
Antenna	AM loop antenna
Antenna terminals	External antenna terminal
Intermediate frequency	450 kHz

Speaker

Front speaker SS-GN88D

Speaker system	3-way, 4-unit, bass-reflex type, magnetically shielded
Speaker units	
Sub woofer	20 cm, cone type
Woofer:	8 cm, cone type
Tweeter:	5 cm, cone type
Nominal impedance	6 ohms
Dimensions (w/h/d)	Approx. 265 x 415 x 320 mm
Mass	Approx. 8.7 kg net per speaker

Surround speaker SS-RS88D for MHC-GN88D

Speaker system	2-way, 3-units, bass-reflex type, magnetically shielded
Speaker units	
Woofer:	10 cm, cone type
Tweeter:	5 cm, cone type
Nominal impedance	8 ohms
Dimensions (w/h/d)	Approx. 175 x 415 x 190 mm
Mass	Approx. 4.8 kg net per speaker

Surround speaker/Center speaker SS-RS77D for MHC-GN77D

Speaker system	1-way, 1-unit, bass-reflex type, magnetically shielded
Speaker units	
Full range	7 x 10 cm, cone type
Nominal impedance	8 ohms
Dimensions (w/h/d)	Approx. 230 x 81 x 121 mm
Mass	Approx. 1.0 kg net per speaker

Center Speaker SS-CT88 for MHC-GN88D

Speaker system	1-way, 2-unit, bass-reflex type, magnetically shielded
Speaker units	
Full range	8 cm, cone type
Nominal Impedance	8 ohms
Dimensions (w/h/d)	Approx. 268 x 107 x 117 mm
Mass	Approx. 1.6 kg net per speaker

continued

Additional Information

Specifications (continued)

General

Power requirements 220 V AC, 50/60 Hz

Power consumption

MHC-GN88D 320 watts

MHC-GN77D 220 watts

Dimensions (w/h/d)

HCD-GN88D/ Approx. 280 x 360 x

HCD-GN77D 386.5 mm

Mass :

HCD-GN88D Approx. 15.2 kg

HCD-GN77D Approx. 12.9 kg

Supplied accessories:

AM loop antenna (1)
Remote commander (1)
Batteries (2)
FM lead antenna (1)
Video cable (1)
Front speaker pads (8)
Center/Surround speaker
pads (12)
Speaker cords (10 m) (2)
(MHC-GN77D only)
Speaker cord (3.5 m) (1)
(MHC-GN77D only)

Design and specifications are subject to change
without notice.

Glossary

Album

Section of a music or picture piece on a data CD containing MP3 audio tracks or JPEG image files.

Chapter

Subdivision of a title on a DVD. A title is composed of several chapters.

Dolby Digital

This sound format for movie theaters is more advanced than Dolby Pro Logic Surround. In this format, the surround speakers output stereo sound with an expanded frequency range and a subwoofer channel for deep bass is independently provided. This format is also called "5.1" because the subwoofer channel is counted as 0.1 channel (since it functions only when a deep bass effect is needed). All six channels in this format are recorded separately to realize superior channel separation. Furthermore, since all the signals are processed digitally, less signal degradation occurs.

Dolby Pro Logic Surround

As one method of decoding Dolby Surround, Dolby Pro Logic Surround produces four channels from two-channel sound. Compared with the former Dolby Surround system, Dolby Pro Logic Surround reproduces left-to-right panning more naturally and localizes sounds more precisely. To take full advantages of Dolby Pro Logic Surround, you should have one pair of surround speakers and a center speaker. The surround speakers output monaural sound.

Dolby Pro Logic II

Dolby Pro Logic II creates five full-bandwidth output channels from two-channel sources. This is done using an advanced, high-purity matrix surround decoder that extracts the spatial properties of the original recording without adding any new sounds or tonal colorations.

Dolby Pro Logic II Movie mode

The Movie mode is for use with stereo television shows and all the programmes encoded in Dolby Surround. The result is enhanced soundfield directionality that approaches the quality of discrete 5.1-channel sound.

Dolby Pro Logic II Music mode

The Music mode is for use with any stereo music recordings, and provides a wide and deep sound space.

DTS

Digital audio compression technology that the Digital Theater Systems, Inc. developed. This technology conforms to 5.1-channel surround. The rear channel is stereo and there is discrete subwoofer channel in this format. DTS provides the same 5.1 discrete channels of high quality digital audio. The good channel separation is realized because the all channel data is recorded discrete and processed in digital.

continued

Additional Information

Glossary (continued)

DVD

A disc that contains up to 8 hours of moving pictures even though its diameter is the same as a CD.

The data capacity of a single-layer and single-sided DVD, at 4.7 GB (Giga Byte), is 7 times that of a CD. Furthermore, the data capacity of a dual-layer and single-sided DVD is 8.5 GB, a single-layer and double-sided DVD 9.4 GB, and a dual-layer and double-sided DVD 17 GB.

The picture data uses the MPEG 2 format, one of the worldwide standards for digital compression technology. The picture data is compressed to about 1/40 of its original size. The DVD also uses variable rate coding technology that changes the data to be allocated according to the status of the picture.

The audio data is recorded in Dolby Digital as well as in PCM, allowing you to enjoy more realistic audio presence.

Furthermore, various advanced functions such as the multi-angle, multilingual, and Parental Control functions are provided with the DVD.

File

Section of a picture on a data CD containing JPEG image files.

Film based software, Video based software

DVDs can be classified as Film based or Video based software. Film based DVDs contain the same images (24 frames per second) that are shown at movie theaters. Video based DVDs, such as television dramas or sit-coms, displays images at 30 frames (or 60 fields) per second.

Index (CD) / Video Index (VIDEO CD)

A number that divides a track into sections to easily locate the point you want on a VIDEO CD or a CD. Depending on the disc, no indexes may be recorded.

Multi-angle function

Various angles, or viewpoints of the video camera, for a scene are recorded on some DVDs.

Multilingual function

Several languages for the sound or subtitles in a picture are recorded on some DVDs.

Parental Control

A function of the DVD to limit playback of the disc by the age of the users according to the limitation level in each country. The limitation varies from disc to disc; when it is activated, playback is completely prohibited, violent scenes are skipped or replaced with other scenes and so on.

Playback Control (PBC)

Signals encoded on VIDEO CDs (Version 2.0) to control playback. By using menu screens recorded on VIDEO CDs with PBC functions, you can enjoy playing simple interactive programs, programs with search functions, and so on.

This system conforms to Version 1.1 and Version 2.0 of VIDEO CD standards. You can enjoy two kinds of playback depending on the disc type.

VIDEO CDs without PBC functions (Version. 1.1 discs)

Enjoy video playback (moving pictures) as well as music.

VIDEO CDs with PBC functions (Version. 2.0 discs)

Play interactive software using menu screens displayed on the TV screen (PBC Playback), in addition to the video playback function of Version 1.1 discs. Moreover, you can play high-resolution still pictures, if they are included on the disc.

Progressive format

Compared to the Interlace format that alternately shows every other line of an image (field) to create one frame, the Progressive format shows the entire image at once as a single frame. This means that while the Interface format can show 30 frames (60 fields) in one second, the Progressive format can show 60 frames in one second. The overall picture quality increases and still images, text, and horizontal lines appear sharper. This system is compatible with 525 progressive format.

Region Code

This system is used to protect copyrights. A region code is allocated on each DVD system or DVD disc according to the sales region. Each region code is shown on the system as well as on the disc packaging. The system can play the discs that match its region code. The system can also play discs with the “” mark. Even when the region code is not shown on the DVD, the region limit may still be activated.

Scene

On a VIDEO CD with PBC functions (page 19), the menu screens, moving pictures and still pictures are divided into sections called “scenes”. Each scene is assigned a scene number enabling you to locate the scene you want.

Title

The longest section of a picture or a music piece on a DVD; a movie, etc., for a picture piece on video software; or an album, etc., for a music piece on audio software. Each title is assigned a title number enabling you to locate the title you want.

Track

Sections of a picture or a music piece on a CD or VIDEO CD. Each track is assigned a track number enabling you to locate the track you want.

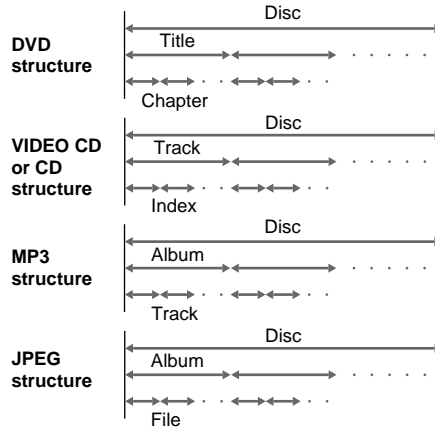

VIDEO CD

A compact disc that contains moving pictures.

The picture data uses the MPEG 1 format, one of the worldwide standards for digital compression technology. The picture data is compressed to about 1/140 of its original size. Consequently, a 12 cm VIDEO CD can contain up to 74 minutes of moving pictures.

VIDEO CDs also contain compact audio data.

Sound outside the range of human hearing are compressed while the sounds we can hear are not compressed. VIDEO CDs can hold 6 times the audio information of conventional audio CDs.

There are 2 versions of VIDEO CDs.

- Version 1.1: You can play only moving pictures and sounds.
- Version 2.0: You can play high-resolution still pictures and enjoy PBC functions.

This system conforms to both versions.



Language code list

For details, see pages 27 and 28.

The language spellings conform to the ISO 639: 1988 (E/F) standard.

Code	Language	Code	Language	Code	Language	Code	Language
1027	Afar	1186	Scots Gaelic	1350	Malayalam	1513	Siswati
1028	Abkhazian	1194	Galician	1352	Mongolian	1514	Sesotho
1032	Afrikaans	1196	Guarani	1353	Moldavian	1515	Sundanese
1039	Amharic	1203	Gujarati	1356	Marathi	1516	Swedish
1044	Arabic	1209	Hausa	1357	Malay	1517	Swahili
1045	Assamese	1217	Hindi	1358	Maltese	1521	Tamil
1051	Aymara	1226	Croatian	1363	Burmese	1525	Telugu
1052	Azerbaijani	1229	Hungarian	1365	Nauru	1527	Tajik
1053	Bashkir	1233	Armenian	1369	Nepali	1528	Thai
1057	Byelorussian	1235	Interlingua	1376	Dutch	1529	Tigrinya
1059	Bulgarian	1239	Interlingue	1379	Norwegian	1531	Turkmen
1060	Bihari	1245	Inupiak	1393	Occitan	1532	Tagalog
1061	Bislama	1248	Indonesian	1403	(Afan) Oromo	1534	Setswana
1066	Bengali; Bangla	1253	Icelandic	1408	Oriya	1535	Tonga
1067	Tibetan	1254	Italian	1417	Punjabi	1538	Turkish
1070	Breton	1257	Hebrew	1428	Polish	1539	Tsonga
1079	Catalan	1261	Japanese	1435	Pashto; Pushto	1540	Tatar
1093	Corsican	1269	Yiddish	1436	Portuguese	1543	Twi
1097	Czech	1283	Javanese	1463	Quechua	1557	Ukrainian
1103	Welsh	1287	Georgian	1481	Rhaeto-Romance	1564	Urdu
1105	Danish	1297	Kazakh	1482	Kirundi	1572	Uzbek
1109	German	1298	Greenlandic	1483	Romanian	1581	Vietnamese
1130	Bhutani	1299	Cambodian	1489	Russian	1587	Volapük
1142	Greek	1300	Kannada	1491	Kinyarwanda	1613	Wolof
1144	English	1301	Korean	1495	Sanskrit	1632	Xhosa
1145	Esperanto	1305	Kashmiri	1498	Sindhi	1665	Yoruba
1149	Spanish	1307	Kurdish	1501	Sangho	1684	Chinese
1150	Estonian	1311	Kirghiz	1502	Serbo-Croatian	1697	Zulu
1151	Basque	1313	Latin	1503	Singhalese	1703	Not specified
1157	Persian	1326	Lingala	1505	Slovak		
1165	Finnish	1327	Laothian	1506	Slovenian		
1166	Fiji	1332	Lithuanian	1507	Samoan		
1171	Faroese	1334	Latvian; Lettish	1508	Shona		
1174	French	1345	Malagasy	1509	Somali		
1181	Frisian	1347	Maori	1511	Albanian		
1183	Irish	1349	Macedonian	1512	Serbian		