

# ***Multi-Channel Integrated Amplifier***

---

Operating Instructions

***TA-DA9000ES***

## WARNING

### To prevent fire or shock hazard, do not expose the unit to rain or moisture.

To prevent fire, do not cover the ventilation of the apparatus with news papers, table-cloths, curtains, etc. And don't place lighted candles on the apparatus.

To prevent fire or shock hazard, do not place objects filled with liquids, such as vases, on the apparatus.

Do not install the appliance in a confined space, such as a bookcase or built-in cabinet.

Install this system so that the power cord can be unplugged from the wall socket immediately in the event of trouble.



Don't throw away batteries with general house waste; dispose of them correctly as chemical waste.

## About This Manual

- The instructions in this manual are for model TA-DA9000ES. Check your model number by looking at the lower right corner of the front panel. In this manual, TA-DA9000ES (area code CEL) is used for illustration purposes unless stated otherwise. Any difference in operation is clearly indicated in the text, for example, "Model of area code CEL only".
- The instructions in this manual describe the controls on the amplifier. You can also use the controls on the supplied remote if they have the same or similar names as those on the amplifier. For details on the use of your remote, see the separate operating instructions supplied with the remote.

### About area codes

The area code of the amplifier you purchased is shown on the upper right portion of the rear panel (see the illustration below).

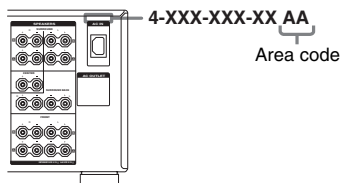

Any differences in operation, according to the area code, are clearly indicated in the text, for example, "Models of area code AA only".

This amplifier incorporates Dolby\* Digital and Pro Logic Surround and the DTS\*\* Digital Surround System.

\* Manufactured under license from Dolby Laboratories.

"Dolby", "Pro Logic" and the double-D symbol are trademarks of Dolby Laboratories.

\*\* "DTS", "DTS-ES Extended Surround", and "Neo:6" are trademarks of Digital Theater Systems, Inc.

# Table of Contents

---

## Getting Started

- 1: Check how to hookup your components ..... 4
  - 1a: Connecting components with digital audio output jacks ..... 6
  - 1b: Connecting components with multi channel output jacks..... 9
  - 1c: Connecting components with only analog audio jacks ..... 11
- 2: Connecting speakers ..... 13
- 3: Connecting the AC power cord ..... 17
- 4: Setting up the speakers ..... 18
- 5: Adjusting the speaker levels and balance ..... 21
  - TEST TONE

---

## Amplifier Operation

- Selecting the component ..... 22
- Listening to multi channel sound..... 23
  - MULTI CH IN
- Changing the display..... 23
- About the indications in the display..... 24

---

## Enjoying Surround Sound

- Using only the front speakers ..... 26
- Enjoying higher fidelity sound..... 26
  - AUTO FORMAT DIRECT
- Selecting a sound field..... 27
- Selecting the surround back decoding mode ..... 29
  - SURR BACK DECODING

---

## Advanced Adjustments and Settings

- Assigning the audio input ..... 31
  - DIGITAL ASSIGN
- Switching the audio input mode for digital components ..... 32
  - INPUT MODE
- Customizing sound fields..... 32
- Adjusting the equalizer ..... 34
- Advanced settings ..... 36
- Storing the adjusted settings ..... 42
  - USER PRESET

---

## Other Operations

- Naming inputs..... 44
- Using the Sleep Timer ..... 44
- Selecting the speaker system ..... 45
- Recording..... 46
- CONTROL A1II Control System ..... 48
- i.LINK connection ..... 49

---

## Additional Information

- Precautions..... 50
- Troubleshooting..... 51
- Specifications..... 53
- List of button locations and reference pages..... 56
- Index ..... 58

# 1: Check how to hookup your components

Steps 1a through 1c beginning on page 6 describe how to hook up your components to this amplifier. Before you begin, refer to “Connectable components” below for the pages which describe how to connect each component.

## Connectable components

Component to be connected	Page
DVD player	
With digital audio output <sup>a)</sup>	6–7
With multi-channel audio output <sup>b)</sup>	9–10
With analog audio output only <sup>c)</sup>	6–7
LD player	
With digital audio output <sup>a)</sup>	6
With analog audio output <sup>c)</sup>	6
TV monitor	
With component video input <sup>d)</sup>	7 or 10
With S-Video or composite video input only	12
Satellite tuner	
With digital audio output <sup>a)</sup>	6–7
With analog audio output only <sup>c)</sup>	6–7
VCR	
With digital audio output <sup>a)</sup>	6
With analog audio output <sup>c)</sup>	6
CD/Super Audio CD player	
With digital audio output <sup>a)</sup>	8
With multi-channel audio output <sup>b)</sup>	9
With analog audio output only <sup>c)</sup>	11
MD/DAT deck	
With digital audio output <sup>a)</sup>	8
With analog audio output only <sup>c)</sup>	11
Tape deck, Analog disc turntable, tuner	11
Multi-channel decoder	9
Video camera, video game, etc.	12

a) Model with a DIGITAL OPTICAL OUTPUT or DIGITAL COAXIAL OUTPUT jack, etc.

b) Model with MULTI CH OUTPUT jacks, etc. This connection is used to output the audio decoded by the component’s internal multi-channel decoder through this amplifier.

c) Model equipped only with AUDIO OUT L/R jacks, etc.

d) Model with component video (Y, P<sub>B</sub>/C<sub>B</sub>/B-Y, P<sub>R</sub>/C<sub>R</sub>/R-Y) input jacks.

## Required cords

The hookup diagrams on the subsequent pages assume the use of the following optional connection cords (**A** to **I**) (not supplied).

### **A** Audio cord

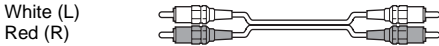

### **B** Audio/video cord

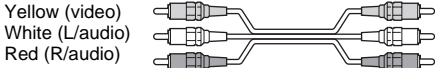

### **C** Video cord



### **D** S-video cord



### **E** Optical digital cord



### **F** Coaxial digital cord



### **G** Monaural audio cord

Black



### **Tip**

Audio cord **A** can be torn into two monaural audio cords **G**.

### **H** Component video cord

Green  
Blue  
Red

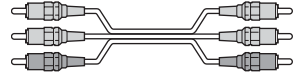

### **I** i.LINK cable



### Notes

- Turn off the power to all components before making any connections.
- Be sure to make connections firmly to avoid hum and noise.
- When connecting an audio/video cord, be sure to match the color-coded pins to the appropriate jacks on the components: yellow (video) to yellow; white (left, audio) to white; and red (right, audio) to red.
- When connecting optical digital cords, insert the cord plugs straight in until they click into place.
- Do not bend or tie optical digital cords.

## If you have Sony components with CONTROL A1II/CONTROL S jacks

See “CONTROL A1II Control System” on page 48.

## If you have Sony component (SCD-XA9000ES) with i.LINK jacks

Use the i.LINK cable (**I**) supplied with SCD-XA9000ES. For details, refer to the Operating Instructions supplied with SCD-XA9000ES.

See also “i.LINK connection” on page 49.

# 1a: Connecting components with digital audio output jacks

## Hooking up a DVD player, LD player, VCR, TV monitor, or satellite tuner

For details on the required cords (**A-I**), see page 5.

### 1 Connect the audio jacks.

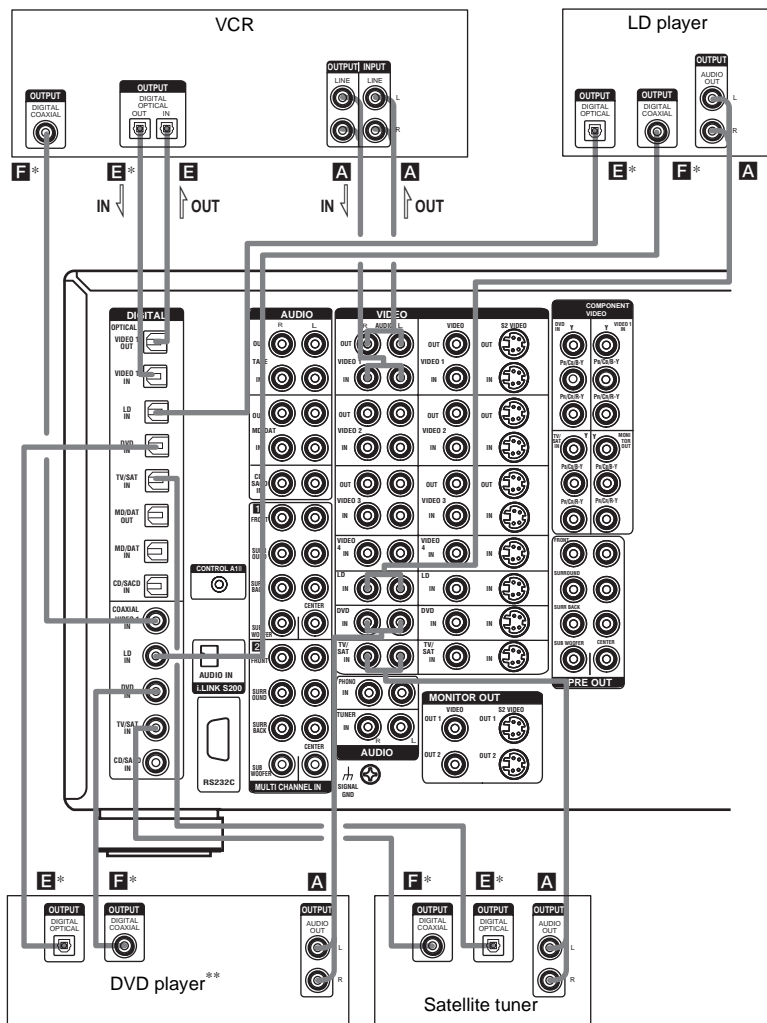

\* Connect to either the DVD COAXIAL IN or the DVD OPTICAL IN jack. We recommend making connections to the DVD COAXIAL IN jack.

\*\* To output the multi channel digital audio, set the digital audio output setting on the DVD player.

## 2 Connect the video jacks.

The following illustration shows how to connect a TV or satellite tuner and a DVD player with COMPONENT VIDEO (Y, P<sub>B</sub>/C<sub>B</sub>/B-Y, P<sub>R</sub>/C<sub>R</sub>/R-Y) output jacks. Connecting a TV with component video input jacks allows you to enjoy higher quality video. You can upconvert the video signals, and adjust the hue, etc. of the converted signals (page 38).

### Notes

- You can listen to the sound of your TV by connecting your TV's audio output jacks to the TV/SAT AUDIO IN jacks on the amplifier. In this case, do not connect the TV's video output jack to the TV/SAT VIDEO IN jack on the amplifier.
- On this amplifier, standard video signals can be converted to component video and S-video signals, in addition S-video signals can be converted to component video signals. However, you cannot convert component video signals downward to standard video or S-video signals.
- When standard video signals (composite video signals) or S-video signals from a VCR etc. are converted upward on this receiver and then output to your TV, depending on the status of the video signal output, the image on the TV screen may appear distorted horizontally or no image may be output.

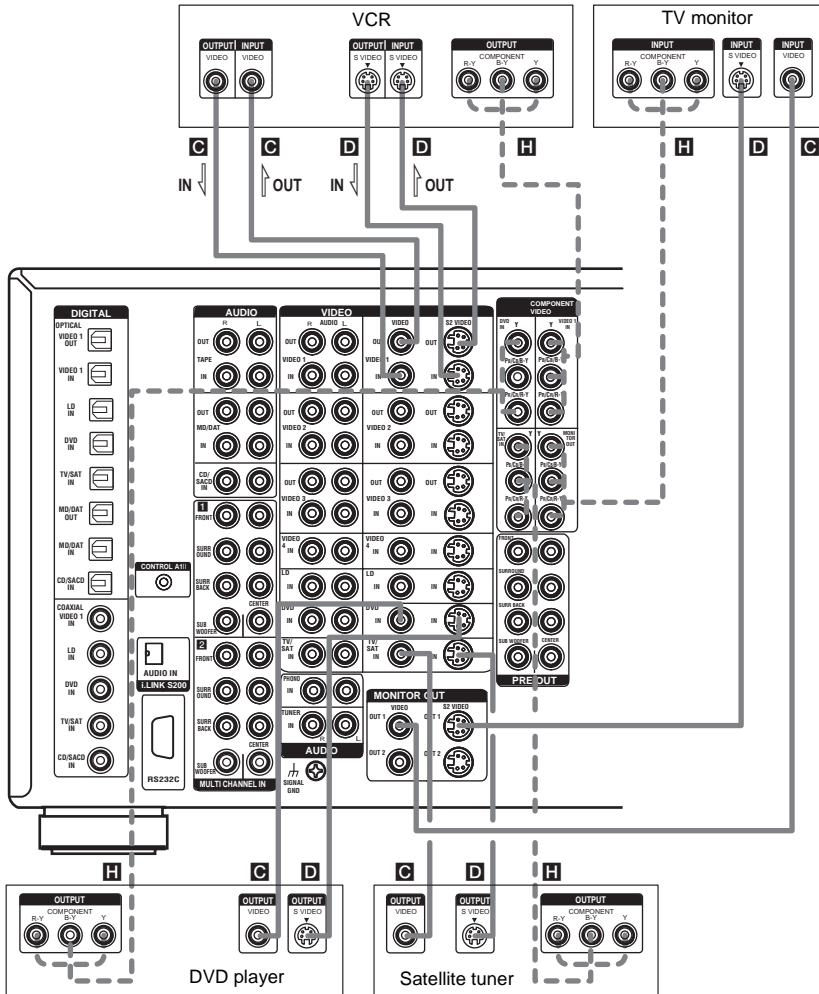

continued

# Hooking up a CD/Super Audio CD player or MD/DAT deck

For details on the required cords (**A**–**I**), see page 5.

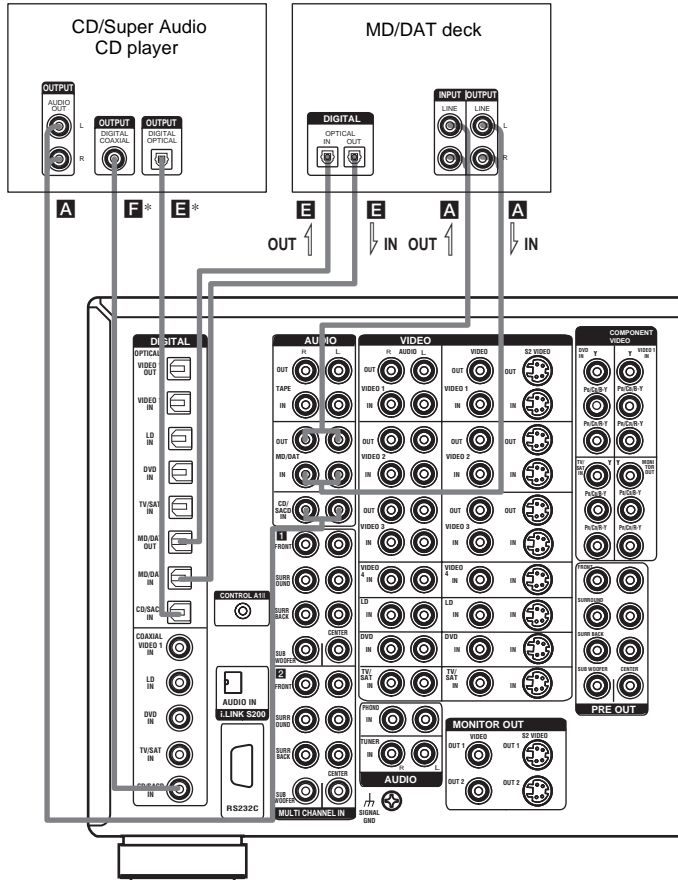

\* Connect to either the CD/SACD COAXIAL IN or the CD/SACD OPTICAL IN jack. We recommend making connections to the CD/SACD COAXIAL IN jack.

## If you want to connect several digital components, but cannot find an unused input

See “Assigning the audio input” (page 31).

### Tip

All the digital audio jacks are compatible with 32 kHz, 44.1 kHz, 48 kHz and 96 kHz sampling frequencies.

### Notes

- No sound is output when playing a Super Audio CD disc on a Super Audio CD player connected to the CD/SACD OPTICAL or CD/SACD COAXIAL IN jack on this amplifier. Connect the player to the analog input jacks (CD/SACD IN jacks). Refer to the operating instructions supplied with the Super Audio CD player.
- You cannot make digital recordings of digital multi channel surround signals.



# 1b: Connecting components with multi channel output jacks

## 1 Connect the audio jacks.

If your DVD or Super Audio CD player is equipped with multi channel output jacks, you can connect it to this amplifier's MULTI CHANNEL INPUT jacks to enjoy the multi channel sound. Alternatively, the multi channel input jacks can be used to connect an external multi channel decoder. For details on the required cords (**A-I**), see page 5.

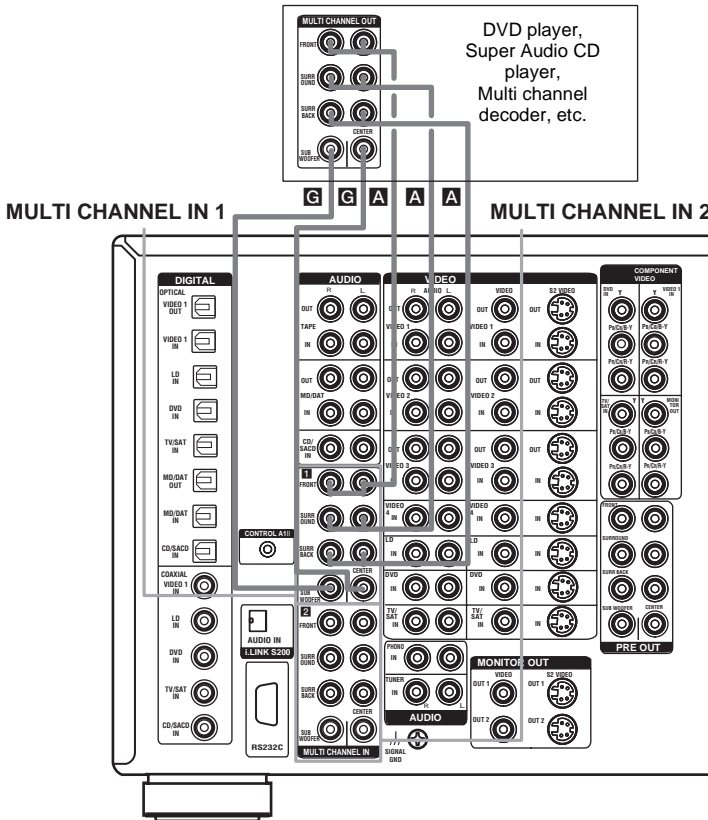

### Tip

This connection also allows you to enjoy software with multi-channel audio recorded in formats other than the Dolby Digital and DTS.

### Note

DVD and Super Audio CD players do not have SURR BACK terminals.

## 2 Connect the video jacks.

The following illustration shows how to connect a DVD player with COMPONENT VIDEO (Y, P<sub>B</sub>/C<sub>B</sub>/B-Y, P<sub>R</sub>/C<sub>R</sub>/R-Y) output jacks. Connecting a TV with component video input jacks allows you to enjoy higher quality video. You can upconvert the video signals, and adjust the hue, etc. of the converted signals (page 38).

### Notes

- On this amplifier, standard video signals can be converted to component video and S-video signals, in addition S-video signals can be converted to component video signals. However, you cannot convert component video signals downward to standard video or S-video signals.
- When standard video signals (composite video signals) or S-video signals from a VCR etc. are converted upward on this receiver and then output to your TV, depending on the status of the video signal output, the image on the TV screen may appear distorted horizontally or no image may be output.

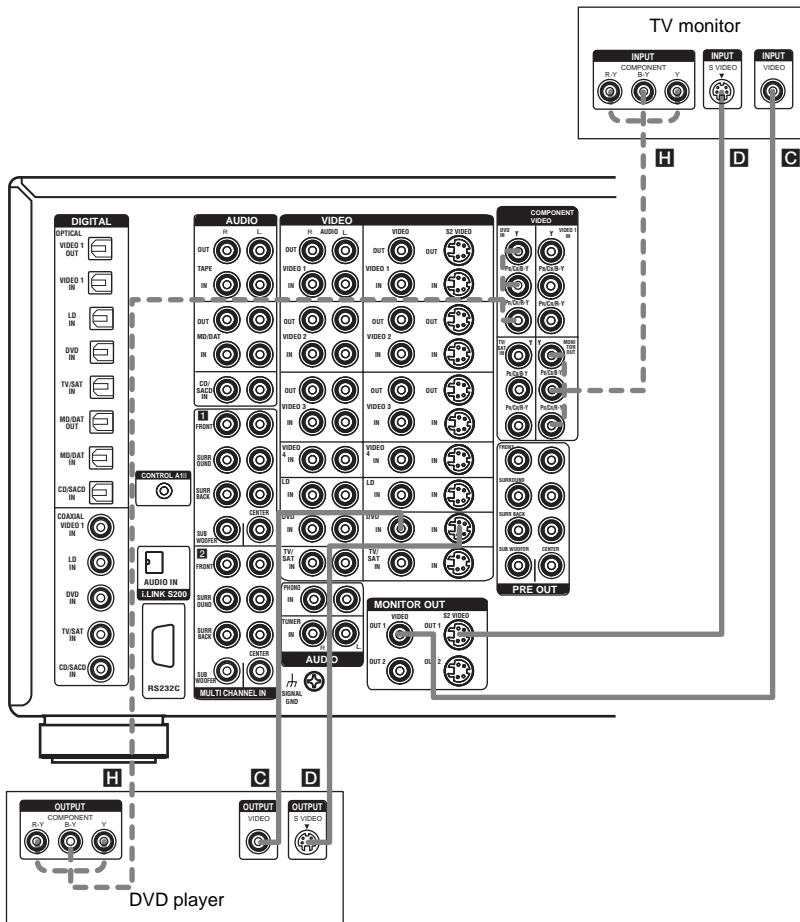

# 1c: Connecting components with only analog audio jacks

## Hooking up audio components

For details on the required cords (**A-I**), see page 5.

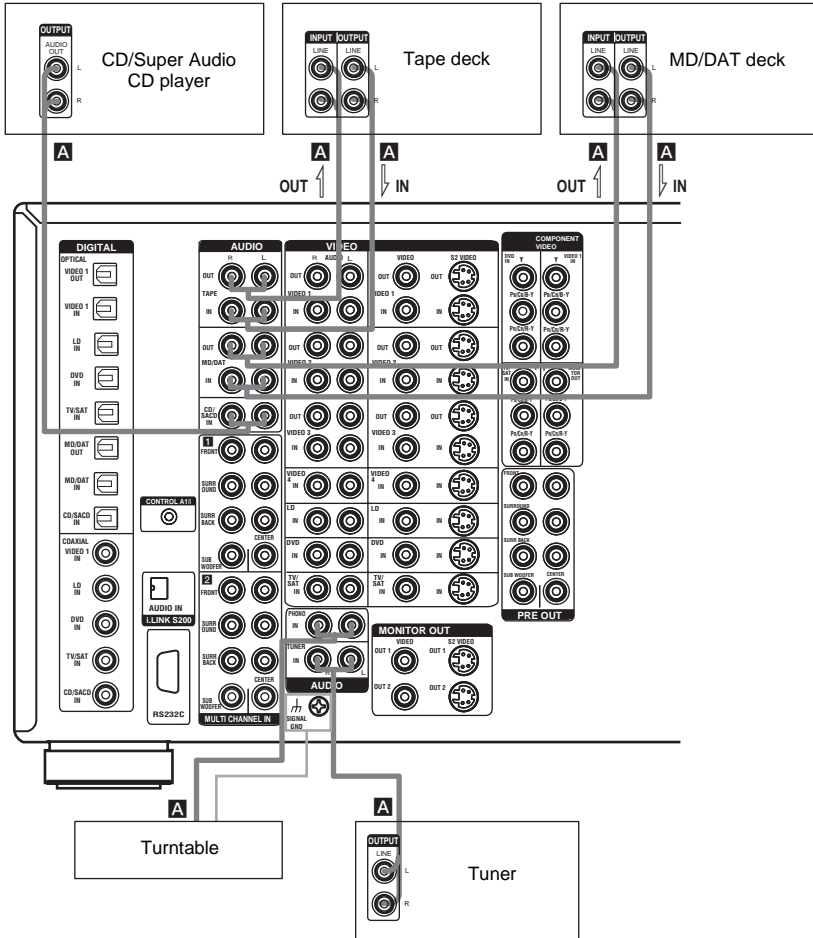

**Note**

If your turntable has a ground wire, connect it to the  $\hbar$  SIGNAL GND terminal.

## Hooking up video components

If you connect your TV to the MONITOR jacks, you can watch the video from the selected input (page 22). You can also display the SPEAKER SET UP, LEVEL, SURR SET UP, EQUALIZER, CUSTOMIZE menu settings and sound fields on your TV by pressing ON SCREEN on the remote. For details on the required cords (A–I), see page 5.

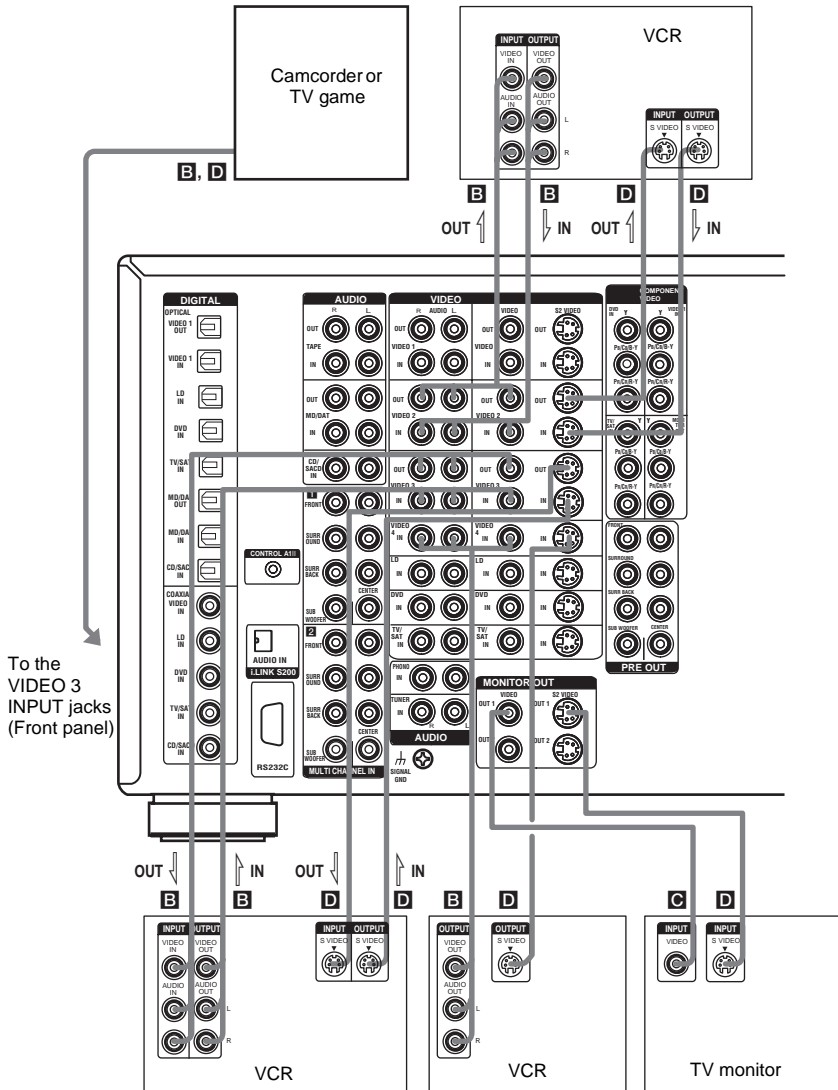

## 2: Connecting speakers

Connect your speakers to the amplifier. This amplifier allows you to use a 9.1 channel system. To fully enjoy theater-like multi channel surround sound requires five speakers (two front speakers, a center speaker, and two surround speakers) and a sub woofer (5.1 channel). You can enjoy high fidelity reproduction of DVD software recorded in the Surround EX format if you connect one additional surround back speaker (6.1 channel) or two surround back speakers (7.1 channel) (see “Selecting the surround back decoding mode” on page 29). You can even enjoy the 9.1 channel surround sound by connecting four surround speakers (see “Selecting the speaker system” on page 45).

### Example of 7.1 channel speaker system configuration

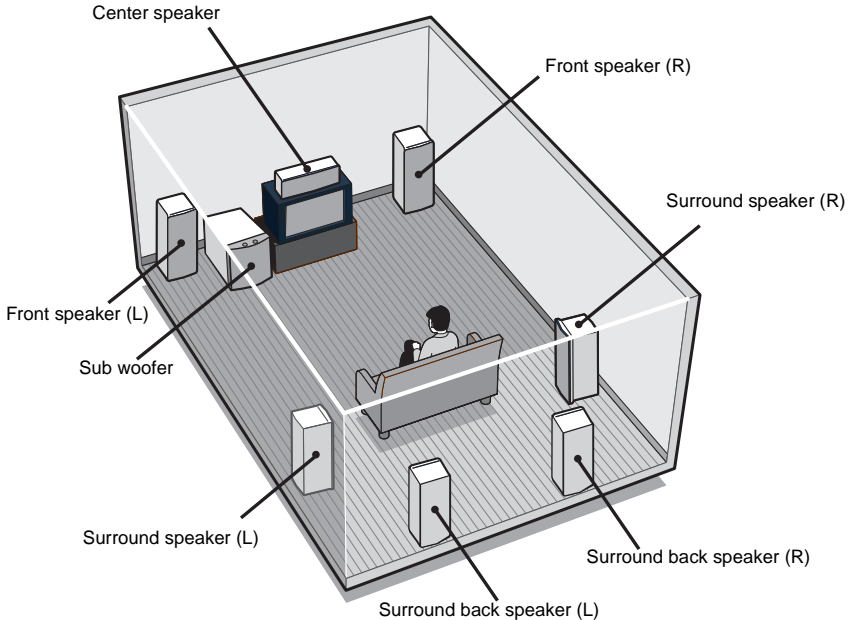

#### Tips

- When you connect 6.1 channel speaker system, place the surround back speaker behind the listening position.
- Since the sub woofer does not emit highly directional signals, you can place it wherever you want.

### Speaker impedance

To enjoy the best possible multi channel surround, connect speakers with a nominal impedance of 8 ohms or higher to the FRONT, CENTER, SURROUND and SURROUND BACK terminals, and set the IMPEDANCE SELECTOR to “8Ω”. Refer to the operating instructions supplied with your speakers if you are not sure of their impedance. (This information is often on the back of the speaker.) Alternatively, you may connect speakers with nominal impedances between 4 and 8 ohms to any or all of the speaker terminals. However, be sure to set the IMPEDANCE SELECTOR to “4Ω” if you connect even one speaker with a nominal impedance between 4 and 8 ohms.

#### Note

Be sure to turn the power off before adjusting the IMPEDANCE SELECTOR.

continued

## Required cords

### A Speaker cords (not supplied)



### B Monaural audio cord (not supplied)

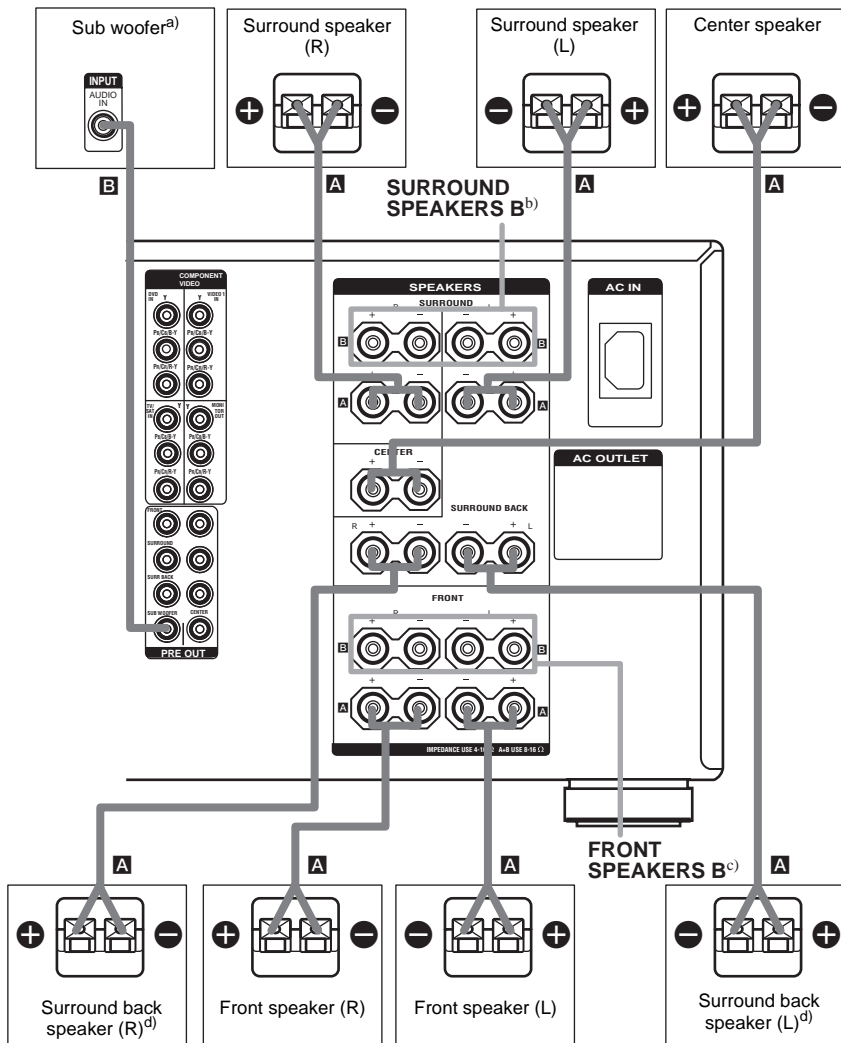

- a) When you connect a sub woofer with an auto standby function, turn off the function when watching movies.
- b) You can select the surround speakers you want to use with SPEAKERS SURROUND. For details, see “Selecting the speaker system” (page 45).
- c) You can select the front speakers you want to use with SPEAKERS FRONT. For details, see “Selecting the speaker system” (page 45).
- d) If you connect only one surround back speaker, connect it to the SURROUND BACK SPEAKERS L terminal.

**Tip (Models of area code U, CA only)**

To connect certain speakers to another power amplifier, use the PRE OUT jacks. The same signal is output from both the SPEAKERS FRONT jacks and the PRE OUT jacks. For example, if you want to connect just the front speakers to another amplifier, connect that amplifier to the PRE OUT FRONT L and R jacks.

## Enjoying the 9.1 channel speaker system

### What is the 9.1 channel speaker system?

A large dubbing theater for recording movie soundtracks uses 10 surround speakers. However, in a small dubbing theater, only 2 speakers each are placed on the right, left, and back walls. Thus, the minimum setup for a dubbing theater is 9.1 channels. When SPEAKERS SURROUND is set to A+B, you can enjoy 9.1 channel speaker operation, just like a dubbing theater.

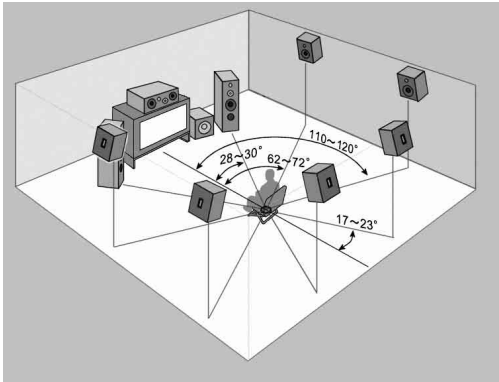

Arrange the speakers around the center of the room based on the angles shown in the illustration on the left. If you are unable to position the speakers according to the angles shown, place one set of surround speakers slightly forward of the listening position (toward the front speakers).

Although the center of the room is used as an axis for determining speaker placement, 9.1 channel speaker operation covers an extremely wide listening area which you can enjoy from anywhere in the room behind the central point.

When using the CINEMA STUDIO EX modes with the 9.1 channel system, be sure to set Virtual Speaker to OFF in SURR SET UP. (You can enjoy the surround effects of movies even without the use of virtual speakers since so many real speakers are used.)

In addition, unlike virtual speakers, the expressive capability of real speakers will vary depending on the speaker. Adjust the effect level so that the actor's lines sound natural and the impact of sound effects is nicely balanced.

The advantage of a 9.1 channel speaker system is a drastic improvement in the connection between the front (video) sound field and the surround sound field. Previously, we have employed virtual speaker technology to present this sound effect, but a real 9.1 channel multi channel surround system has a much wider effect area so that all family members can enjoy the surround effect. Of course, when seated in the middle of the listening position, you can enjoy the sound exactly as the movie director listened.

### Tips for placing speakers

Place surround speakers B between the front speakers and the listening position. Adjusting the position of these speakers improves the connection between the front and surround sound stage.

### **Tips for using the 9.1 channel speaker system**

You can also use the CINEMA STUDIO EX modes with the 9.1 channel speaker system. In this case, the number of virtual surround speakers doubles (for a total of 12 virtual surround speakers).

However, this large number of speakers may narrow the surround effect area. Thus, it may be more effective to set "VIR.SPEAKERS" in the SURR SET UP menu to "OFF".

Please note that the front L/R and center speakers are common to all modes, and this function only changes the use of the surround speakers. Depending on how you use SPEAKERS FRONT to switch the front speaker system (A/B), and how you set "CENTER SP" in the SPEAKER SET UP menu ("YES" or "MIX"), you can set up two completely different systems. For example, you can set up a 2 channel or 4 channel speaker system for pure audio sources, and a 7.1 channel speaker system for AV sources.

Please note that in most cases you can use the 9.1 channel setting for Super Audio CD and other pure audio sources without any adjustments. However, depending on the type of speakers you have and the way the music software was recorded, you may want to switch to 7.1 channel or 5.1 channel playback. In such cases, you should set up your surround speaker system to switch between A and B. Use surround speakers B for 5.1 channel operation and surround speakers A+B for 9.1 channel operation.



### 3: Connecting the AC power cord

Connect the supplied AC power cord to the AC IN terminal on the amplifier, then connect the AC power cord to a wall outlet.

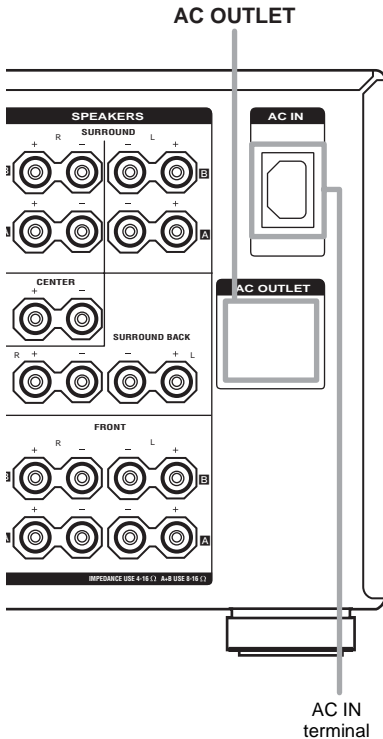
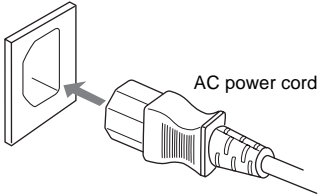

\* The configuration, shape, and number of AC outlets vary according to the area code.

#### Notes

- The AC OUTLET(s) on the rear of the amplifier is a switched outlet, which supplies power to the

connected component only while the amplifier is turned on.

- Make sure that the total power consumption of the component(s) connected to the amplifier's AC OUTLET(s) does not exceed the wattage stated on the rear panel. Do not connect high-wattage electrical home appliances such as electric irons, fans, or TVs to this outlet. This may cause a malfunction.

### Performing initial setup operations

Before using the amplifier for the first time, initialize the amplifier by performing the following procedure.

This procedure can also be used to return settings you have made to their factory defaults.

**1 Press I/⏻ to turn off the amplifier.**

**2 Hold down I/⏻ for 5 seconds.**

“ENTER to Clear ALL” appears in the display for 10 seconds.

**3 Press ENTER while “ENTER to Clear ALL” appears in the display.**

After “MEMORY CLEARING...” appears in the display for a while, “MEMORY CLEARED!” appears.

The following are reset to their factory settings.

- All settings in the SPEAKER SET UP, LEVEL, SURR SET UP, EQUALIZER, and CUSTOMIZE menus.
- The sound field memorized for each input.
- All index names for inputs.

## 4: Setting up the speakers

You can use the **SPEAKER SET UP** menu to set the size and distance of the speakers connected to this system.

**1** Press **I/⏻** to turn on the system.

**2** Rotate **MAIN MENU** to select “**SPEAKER SET UP**”.

**3** Rotate **MENU** to select the menu item you want.

For more information, see “Speaker setup parameters”.

### Notes

- Certain setup parameters may be dimmed in the display. This means that the selected parameter is either unavailable or fixed and unchangeable due to sound field (pages 27–29) or other settings.
- Some speaker setup items may appear dimmed in the display. This means that they have been adjusted automatically due to other speaker settings. Depending on the settings, you may or may not be able to adjust certain speakers.

**4** Rotate **-/+** to select the parameter.

**5** Repeat steps 3 and 4 until you have set all of the items that follow.

### Note

Before setting up the surround speakers, select the surround speakers you use (page 45).

---

## Speaker setup parameters

The initial settings are underlined.

### ■ SP EASY SET UP (Speaker easy setup)

- YES  
You can set up your speakers automatically by selecting a pre-defined speaker pattern (see the supplied “Easy Setup Guide”).
- NO  
Select to adjust the settings of each speaker manually.

### ■ SPEAKER PATTERN (Speaker setup pattern)

When “**SP EASY SET UP**” is set to “**YES**”, select the speaker setup pattern. Rotate **-/+** to select the speaker setup pattern and press

**ENTER** to enter the selection. Check your speaker pattern using the supplied “Easy Setup Guide”.

### ■ SUB WOOFER (Sub woofer)

- YES  
If you connect a sub woofer, select “**YES**”.
- NO  
If you did not connect a sub woofer, select “**NO**”. This activates the bass redirection circuitry and outputs the LFE signals from other speakers.

### Tip

In order to take full advantage of the Dolby Digital bass redirection circuitry, we recommend setting the sub woofer’s cut off frequency as high as possible.

### ■ FRONT SP (Front speakers)

- LARGE  
If you connect large speakers that will effectively reproduce bass frequencies, select “**LARGE**”. Normally, select “**LARGE**”.  
When the sub woofer is set to “**NO**”, front speakers are automatically set to “**LARGE**”.
- SMALL  
If the sound is distorted, or you feel a lack of surround effects when using multi channel surround sound, select “**SMALL**” to activate the bass redirection circuitry and output the front channel bass frequencies from the sub woofer. When the front speakers are set to “**SMALL**”, the center, surround and surround back speakers are also automatically set to “**SMALL**” (unless previously set to “**NO**”).

### ■ CENTER SP (Center speaker)

- LARGE  
If you connect a large speaker that will effectively reproduce bass frequencies, select “**LARGE**”. Normally, select “**LARGE**”.  
However, if the front speakers are set to “**SMALL**”, you cannot set the center speaker to “**LARGE**”.
- SMALL  
If the sound is distorted, or you feel a lack of surround effects when using multi channel surround sound, select “**SMALL**” to activate the bass redirection circuitry and output the center channel bass frequencies from the front speakers (if set to “**LARGE**”) or sub woofer.

- NO or MIX

If you did not connect a center speaker, select “NO” or “MIX”. When set to “MIX”, the sound of the center speaker can be output from the front speakers without deteriorating the sound quality. For details, see “MIX SCALING” in the CUSTOMIZE menu (page 37). The sound of the center channel will be output from the front speakers.

When the multi channel input is selected, analog downmixing is performed. Whether the setting is “NO” or “MIX”.

- **SURROUND SP-A**  
(Surround speaker-A)

- **SURROUND SP-B**  
(Surround speaker-B)

The surround back speakers are set to the same setting.

- **LARGE**

If you connect large speakers that will effectively reproduce bass frequencies, select “LARGE”. Normally, select “LARGE”.

However, if the front speakers are set to “SMALL”, you cannot set the surround speakers to “LARGE”.

- **SMALL**

If the sound is distorted, or you feel a lack of surround effects when using multi channel surround sound, select “SMALL” to activate the bass redirection circuitry and output the surround channel bass frequencies from the sub woofer or other “LARGE” speakers.

- **NO**

If you did not connect surround speakers, select “NO”.

**Tip**

When the SPEAKERS SURROUND switch is set to A+B, the settings for surround speaker-A are also set for surround speaker-B.

- **SURR BACK SP**  
(Surround back speakers)

When the surround speakers are set to “NO”, the surround back speakers are also automatically set to “NO” and the setting cannot be changed.

- **DUAL**

If you connect two surround back speakers, select “DUAL”. The sound will be output to a maximum of 7.1 channels.

- **SINGLE**

If you connect only one surround back speaker, select “SINGLE”. The sound will be output to a maximum of 6.1 channels.

- **NO**

If you did not connect surround back speakers, select “NO”.

**Tip**

The “LARGE” and “SMALL” settings for each speaker determine whether or not the internal sound processor will cut the bass signal from that channel. When the bass is cut from a channel, the bass redirection circuitry sends the corresponding bass frequencies to the sub woofer or other “LARGE” speakers.

However, it best not to cut them, if possible. Therefore, even when using small speakers, you can set them to “LARGE” if you want to output the bass frequencies from that speaker. On the other hand, if you are using a large speaker, but prefer not to have bass frequencies output from that speaker, set it to “SMALL”.

If the overall sound level is lower than you prefer, set all speakers to “LARGE”. If there is not enough bass, you can use the equalizer to boost the bass levels. To adjust the equalizer, see page 34.

- **FRONT XXX meter**  
(Front speaker distance)

Initial setting: 3.0 meter

Lets you set the distance from your listening position to the front speakers (A). You can adjust from 1.0 meter to 7.0 meters in 0.1 meter steps.

If both front speakers are not placed an equal distance from your listening position, set the distance to the closest speaker.

When placing only one surround back speaker

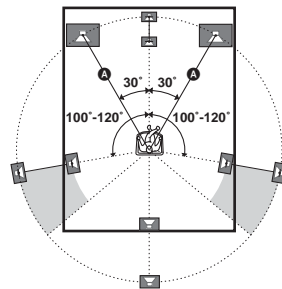

When placing two surround back speakers  
(The angle **B** should be the same)

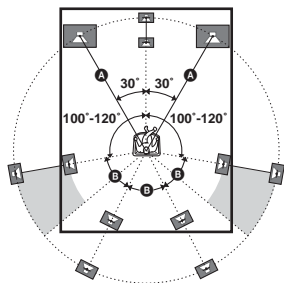

■ **CENTER XXX meter**  
(Center speaker distance)

Initial setting: 3.0 meter

Lets you set the distance from your listening position to the center speaker. You can adjust from 1.0 meter to 7.0 meters in 0.1 meter steps.

■ **SURROUND-A XXX meter**  
(Surround speaker-A distance)

■ **SURROUND-B XXX meter**  
(Surround speaker-B distance)

Initial setting: 3.0 meter

Lets you set the distance from your listening position to the surround speakers. You can adjust from 1.0 meter to 7.0 meters in 0.1 meter steps.

If both surround speakers are not placed an equal distance from your listening position, set the distance to the closest speaker.

■ **SURR BACK XXX meter**  
(Surround back speaker distance)

Initial setting: 3.0 meter

Lets you set the distance from your listening position to the surround back speaker. You can adjust from 1.0 meter to 7.0 meters in 0.1 meter steps.

If you connect two surround back speakers and both surround back speakers are not placed an equal distance from your listening position, set the distance to the closest speaker.

■ **SUB WOOFER XXX meter**  
(Sub woofer distance)

Initial setting: 3.0 meter

Lets you set the distance from your listening position to the sub woofer. You can adjust from 1.0 meter to 7.0 meters in 0.1 meter steps.

**Tip**

The amplifier lets you to input the speaker position in terms of distance. However, it is not possible to set the center speaker further than the front speakers. Also, the center speaker cannot be set more that 1.5 meters closer than the front speakers.

Likewise, the surround speakers can not be set farther away from the listening position than the front speakers. And they can be no more than 4.5 meters closer.

This is because incorrect speaker placement is not conducive to the enjoyment of surround sound.

Please note that, setting the speaker distance closer than the actual location of the speakers will cause a delay in the output of the sound from that speaker. In other words, the speaker will sound like it is farther away.

For example, setting the center speaker distance 1–2 meters closer than the actual speaker position will create a fairly realistic sensation of being “inside” the screen. If you cannot obtain a satisfactory surround effect because the surround speakers are too close, setting the surround speaker distance closer (shorter) than the actual distance will create a larger sound stage. Adjusting these parameter while listening to the sound often results in much better surround sound. Give it a try!

**For advanced speaker setups**

Use the CUSTOMIZE menu and set “MENU EXPAND” to “ON”. This enables advanced setups including surround speaker positioning. For details on “MENU EXPAND”, see page 36. For details on how to set the items, see page 38.

## 5: Adjusting the speaker levels and balance

### — TEST TONE

Adjust the speaker levels and balance while listening the test tone from your listening position. Use the remote for these operations. For details on remote operations, refer to the operating instructions supplied with the remote.

#### Tip

The amplifier employs a test tone with a frequency centered at 800 Hz.

- 1** Press **I/⏻** on the remote to turn on the amplifier.
- 2** Press **<** on the remote repeatedly until **RECEIVER** menu appears.
- 3** Move the easy scroll key to select **“TEST TONE”**, then press the key to enter the selection.  
 “TEST TONE” in the LEVEL menu appears in the display and the test tone is output from each speaker in sequence.
- 4** Adjust the speaker level and balance using the LEVEL menu so that the level of the test tone sounds the same from each speaker.

For details on the LEVEL menu settings, see page 33.

#### Tips

- To adjust the level of all speakers at the same time, press **MASTER VOL +/-** on the remote or turn **MASTER VOLUME** on the amplifier.
- You can also use **TEST TONE** on the amplifier to turn on or off the test tone.
- You can also use **-/+** on the amplifier for the adjustment.

- 5** After the adjustment, press **<** on the remote repeatedly again until amplifier menu appears.
- 6** Move the easy scroll key to select **“TEST TONE”**, then press the key repeatedly to select **“TEST TONE [OFF]”**.

The test tone turns off.

### To output the test tone only from a specific speaker

Set **“TEST TONE”** in the LEVEL menu to **“FIX”** (page 33). The test tone is output only from the selected speaker.

### For more precise adjustment

You can output the test tone or sound source from two adjacent speakers to adjust their balance and level.

Set **“MENU EXPAND”** in the CUSTOMIZE menu to **“ON”** (page 36). Then select the two speakers you want to adjust using **“PHASE NOISE”** or **“PHASE AUDIO”** in the LEVEL menu (page 41).

## Amplifier Operation

### Selecting the component

#### 1 Rotate INPUT SELECTOR to select the input.

The selected input appears in the display.

To select the	Display
VCR	VIDEO 1, VIDEO 2, VIDEO 3 or VIDEO 4
Camcorder or TV game	VIDEO 5
LD player	LD
DVD player	DVD
Satellite tuner	TV/SAT
Tape deck	TAPE
MD or DAT deck	MD/DAT
CD or Super Audio CD player	CD/SACD
Tuner	TUNER
Turntable	PHONO
i.LINK component*	i.LINK

\* See "Note when "i.LINK" is selected" below.

#### 2 Turn on the component and start playback.

#### 3 Rotate MASTER VOLUME to adjust the volume.

##### Note when "i.LINK" is selected

When "i.POWER" is set to "AUTO" (page 36), the power of the i.LINK circuits turns on after "i.LINK" is selected, and "i.LINK Connecting" appears in the display while the power of the i.LINK circuits is turning on. While this message appears, no sound is output because LINC is not established. (See page 49 for details on LINC.)

Make sure to control the player after "i.LINK Connecting" turns off.

The connected i.LINK component name appears except in the following cases.

"No LINC": No i.LINK component is connected when "i.LINK" is selected.

"Disc": The amplifier could obtain only general information from the connected component.

"Unknown": The amplifier could not obtain information from the connected component.

#### To mute the sound

Press MUTING on the remote. To cancel, press MUTING on the remote again or turn MASTER VOLUME clockwise to raise the volume. Even if you turn off the amplifier, the muting function continues to mute the sound when you turn the amplifier back on.

#### Note on using headphones

When headphones are connected, you can select only the following sound fields (page 28).

- HEADPHONE (2CH)
- HEADPHONE (DIRECT)
- HEADPHONE (MULTI 1)
- HEADPHONE (MULTI 2)
- HEADPHONE THEATER

## Listening to multi channel sound

### — MULTI CH IN

You can select the audio directly from the components connected to the MULTI CHANNEL IN jacks. This enables you to enjoy high quality analog inputs like DVD or Super Audio CD.

Surround effects and LIP SYNC (page 37) are not activated when using this input.

**Press MULTI CH IN 1/2 repeatedly to select the multi channel audio source (“MULTI CH 1” or “MULTI CH IN 2”).**

The selected audio source is output.

#### Note

This function is canceled when you select the sound field indication by pressing MULTI CH IN 1/2, or when you switch the input or sound field (page 26-29).

### When a center speaker or sub woofer is not connected (Analog downmix function)

If you have set the center speaker to “NO” or “MIX”, or set the sub woofer to “NO” in the SPEAKER SET UP menu (page 18), and you activate the MULTI CH IN function, the analog center or sub woofer audio will be output from the front left and right speakers.

## Changing the display

### Changing the information in the display

You can check the sound field etc. by changing the information in the display.

**Press DISPLAY repeatedly.**

Each time you press DISPLAY, the display will change as follows.

Index name\* and sound field name ↔ Input name and sound field name

\* Index name appears only when you have assigned one to the input (page 44). Index name does not appear when only blank spaces have been entered, or it is the same as the input name.

### Displaying the input stream information

You can check the input stream information (about format, channel, etc.) of digital input signals. The input stream information also appears for 4 seconds when the amplifier detects any changes in the digital input signal.

- 1** Rotate MAIN MENU to select “STREAM INFO”.
- 2** Rotate MENU.  
The input stream information appears.
- 3** Rotate -/+ for more information.

### Changing the brightness of the display

**Press DIMMER repeatedly.**

The brightness of the display changes in 3 steps (0% DOWN, 60% DOWN, 100% DOWN\*).

\* When 100% DOWN is selected, the indication “100% DOWN” does not appear in the display.

## About the indications in the display

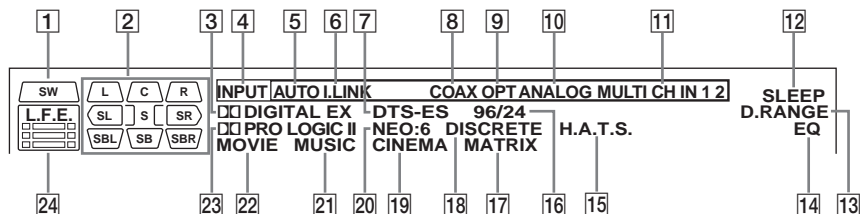

- 1 **SW:** Lights up when sub woofer selection is set to “YES” (page 18). While this indicator lights up, the amplifier creates a sub woofer signal based on the LFE signal in the disc being played back or the low frequency components of the front channels. This indicator does not light during the 2CH STEREO mode or when 2 channel signal is input while [A.F.D. AUTO] is selected and [A.F.D. 2CH SW] in the SURR SET UP menu is set to “OFF”.
- 2 **Playback channel indicators:** The letters (L, C, R, etc.) indicate the channels being played back. The boxes around the letters vary to show how the amplifier downmixes the source sound (based on the speakers settings). L (Front Left), R (Front Right), C (Center (monaural)), SL (Surround Left), SR (Surround Right), S (Surround (monaural) or the surround components obtained by Pro Logic processing), SBL (Surround back Left)\*, SBR (Surround back right)\*, SB (Surround Back (the surround back components obtained by 6.1 channel decoding))
 

**Example:**  
Recording format (Front /Surround): 3/2.1  
Output channel: Surround speakers absent  
Sound Field: A.F.D. AUTO

\* Lights up when the test tone for SBL or SBR signal is output.
- 3 **DIGITAL (EX):** Lights up when Dolby Digital signals are input. “EX” lights up when Dolby Digital EX signals are input.
- 4 **INPUT:** Lights up constantly. One of the input indicators also lights up according to the current input.
- 5 **AUTO:** Lights up when INPUT MODE is set to “AUTO 2CH” (page 32).
- 6 **i.LINK:** Lights up when an i.LINK component is connected.
- 7 **DTS (-ES):** Lights up when DTS signals are input. “-ES” lights up when DTS-ES signals are input. When playing a DTS format disc, be sure that you have made digital connections and that INPUT MODE is NOT set to “ANALOG 2CH FIXED” (page 32).
- 8 **COAX:** Lights up when INPUT MODE is set to “AUTO” and the source signal is a digital signal being input through the COAXIAL terminal, or when INPUT MODE is set to “COAXIAL FIXED” (page 32).
- 9 **OPT:** Lights up when INPUT MODE is set to “AUTO” and the source signal is a digital signal being input through the OPTICAL terminal, or when INPUT MODE is set to “OPTICAL FIXED” (page 32).
- 10 **ANALOG:** Lights up when INPUT MODE is set to “AUTO” and no digital signal is input to COAXIAL or OPTICAL jack, or when INPUT MODE is set to “ANALOG 2CH FIXED” (page 32).
- 11 **MULTI CH IN 1/2:** Lights up when “MULTI CH IN 1” or “MULTI CH IN 2” is selected.
- 12 **SLEEP:** Lights up when sleep timer is activated.
- 13 **D.RANGE:** Lights up when dynamic range compression is activated (page 41).
- 14 **EQ:** Lights up when the equalizer is activated.



- 15 **H.A.T.S.:** Lights up when the connected i.LINK component is compatible with the H.A.T.S. function.
- 16 **96/24:** Lights up when the amplifier is decoding DTS 96 kHz/24 bit signals.
- 17 **MATRIX:** Lights up when DTS-ES Matrix decoding is activated.
- 18 **DISCRETE:** Lights up when DTS-ES Discrete decoding is activated.
- 19 **CINEMA:** Lights up when DTS Neo:6 Cinema decoding is activated.
- 20 **NEO:6:** Lights up when DTS Neo:6 Cinema/Music decoding is activated.
- 21 **MUSIC:** Lights up when Pro Logic **II** Music or DTS Neo:6 Music decoding is activated.
- 22 **MOVIE:** Lights up when Pro Logic **II** Movie decoding is activated.
- 23 **□□ PRO LOGIC (II):** Lights up when the amplifier applies Pro Logic processing to 2 channel signals in order to output the center and surround channel signals. This indicator also lights when the Pro Logic **II** Movie/Music decoder is activated. However, this indicator does not light if both the center and surround speakers are set to “NO”.
- 24 **L.F.E.:** Lights up when the disc being played back contains the LFE (Low Frequency Effect) channel. When the sound of the LFE channel signal is actually being reproduced, the bars underneath the letters lights up to indicate the level. Since the LFE signal is not recorded in all parts of the input signal the bar indication will fluctuate (and may turn off) during playback.

## Enjoying Surround Sound

### Using only the front speakers

In this mode, the amplifier outputs the sound from the front L/R speakers only. There is no sound from the sub woofer.

### Listening to 2 channel stereo sources (2CH STEREO)

Standard 2 channel stereo sources completely bypass the sound field processing and multi channel surround formats are downmixed to 2 channel.

#### Press 2CH.

“2CH STEREO” appears in the display and the amplifier switches to the 2CH STEREO mode.

#### Note

No sound is output from the sub woofer in the 2CH STEREO mode. To listen to the 2 channel stereo sources using the front L/R speakers and a sub woofer, select “A.F.D. AUTO” and set “A.F.D. 2CH SW” in the SURR SET UP menu to “CREATE”.

## Enjoying higher fidelity sound

### — AUTO FORMAT DIRECT

The Auto Format Direct (A.F.D.) mode allows you to select the decoding mode you want for your audio sound.

A.F.D. mode	Decoding mode
AUTO	As encoded
PRO LOGIC	Dolby Pro Logic
PRO LOGIC II MOVIE	Dolby Pro Logic II
PRO LOGIC II MUSIC	
Neo:6 Cinema	DTS Neo:6
Neo:6 Music	
Multi Stereo	Multi Stereo

### Decoding the input audio signal automatically

In this mode, the amplifier automatically detects the type of audio signal being input (Dolby Digital, DTS, standard 2 channel stereo, etc.) and performs the proper decoding if necessary. This mode presents the sound as it was recorded/encoded, without adding any surround effects. However, when “A.F.D. 2CH SW” in the SURR SET UP menu is set to “CREATE” and if there are no low frequency signals (Dolby Digital LFE, etc.) it will generate a low frequency signal for output to the sub woofer.

#### Press A.F.D. repeatedly to select “A.F.D. AUTO”.

The amplifier automatically detects the type of audio signal being input and performs the proper decoding if necessary.

#### Tip

In most cases, “A.F.D. AUTO” provides the most appropriate decoding. You may want to use SURR BACK DECODING (page 29) to match the input stream to the mode you prefer.

## Enjoying stereo sound in multi channel (2 channel decoding mode)

This mode lets you specify the type of decoding for 2 channel audio sources. This amplifier can reproduce 2 channel sound in 5 channels through Dolby Pro Logic II; 6 channels through DTS Neo:6; or 4 channels through Dolby Pro Logic. However, DTS 2CH sources are not decoded by DTS Neo:6; they are output in 2 channels. When the multi channel signal are input, the encoded multi channel signals are output as they are.

**Press A.F.D. repeatedly to select the 2 channel decoding mode.**

### ■ PRO LOGIC

Performs Dolby Pro Logic decoding. The source recorded in 2 channel is decoded into 4 channels.

### ■ PRO LOGIC II MOVIE

Performs Dolby Pro Logic II Movie mode decoding. This setting is ideal for movies encoded in Dolby Surround. In Addition, this mode can reproduce sound in 5.1 channel when watching videos of overdubbed or old movies.

### ■ PRO LOGIC II MUSIC

Performs the Dolby Pro Logic II Music mode decoding. This setting is ideal for normal stereo sources such as CDs.

### ■ Neo:6 Cinema

Performs the DTS Neo:6 Cinema mode decoding.

### ■ Neo:6 Music

Performs the DTS Neo:6 Music mode decoding. This setting is ideal for normal stereo sources such as CDs.

### ■ MULTI STEREO

Outputs the 2 channel L/R signals from all speakers.

## If you connect a sub woofer

When the source signal does not include a LFE signal, the amplifier generates a low frequency signal for output to the sub woofer. However the low frequency signal is not generated for “Neo:6 Cinema” or “Neo:6 Music” when all speakers are set to “LARGE”.

## Selecting a sound field

You can take advantage of surround sound simply by selecting one of the amplifier’s pre-programmed sound fields. They bring the exciting and powerful sound of movie theaters and concert halls into your home.

## Selecting a sound field for movies

**Press MOVIE repeatedly to select the sound field you want.**

The selected sound field appears in the display.

### Sound field

CINEMA STUDIO EX A **DCS**

CINEMA STUDIO EX B **DCS**

CINEMA STUDIO EX C **DCS**

V.MULTI DIMENSION **DCS**

## About DCS (Digital Cinema Sound)

Sound fields marked **DCS** use DCS technology.

DCS is the concept name of the surround technology for home theater developed by Sony. DCS uses the DSP (Digital Signal Processor) technology to reproduce the sound characteristics of an actual cinema cutting studio in Hollywood.

When played at home, DCS will create a powerful theater effect that mimics the artistic combination of sound and action as envisioned by the movie director.

When a sound field with the **DCS** mark is selected, Digital Cinema Sound indicator lights up.

### ■ CINEMA STUDIO EX A **DCS**

Reproduces the sound characteristics of the Sony Pictures Entertainment “Cary Grant Theater” cinema production studio. This is a standard mode, great for watching most any type of movies.

### ■ CINEMA STUDIO EX B **DCS**

Reproduces the sound characteristics of the Sony Pictures Entertainment “Kim Novak Theater” cinema production studio. This mode is ideal for watching

science-fiction or action movies with lots of sound effects.

### ■ CINEMA STUDIO EX C **DCS**

Reproduces the sound characteristics of the Sony Pictures Entertainment scoring stage. This mode is ideal for watching musicals or films where orchestra music is featured in the soundtrack.

### ■ V.MULTI DIMENSION **DCS**

Creates 5 sets of virtual speakers from a single pair of actual surround speakers.

## About CINEMA STUDIO EX modes

CINEMA STUDIO EX modes are suitable for watching motion picture DVDs (etc.), with multi channel surround effects. You can reproduce the sound characteristics of Sony Pictures Entertainment's dubbing studio in your home.



The CINEMA STUDIO EX modes consist of the following three elements.

- Virtual Multi Dimension  
Creates 5 sets of virtual speakers from a single pair of actual surround speakers.
- Screen Depth Matching  
Creates the sensation that the sound is coming from inside the screen like in theaters.
- Cinema Studio Reverberation  
Reproduces the type of reverberation found in theaters.

The CINEMA STUDIO EX modes integrate these three elements simultaneously.

### Tips

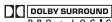
You can identify the encoding format of DVD software, etc. by looking at the logo on the package.

-  : Dolby Digital discs
-  : Dolby Surround encoded programs
-  : DTS Digital Surround encoded programs

### Notes

- The effects provided by the virtual speakers may cause increased noise in the playback signal.
- When listening with sound fields that employ the virtual speakers, you will not be able to hear any sound coming directly from the surround speakers.

---

## Selecting a sound field for music

Press **MUSIC** repeatedly to select the sound field you want.

The selected sound field appears in the display.

---

### Sound field

---

D.CONCERT HALL A

D.CONCERT HALL B

CHURCH

JAZZ CLUB

LIVE CONCERT

STADIUM

SPORTS

---

### ■ D.CONCERT HALL A

Uses 3D sound imaging to reproduce the sound characteristics of the CONCERTGEBOUW in Amsterdam, which is famous for a large sound stage produced by reflectivity.

### ■ D.CONCERT HALL B

Uses 3D sound imaging to reproduce the sound characteristics of the MUSIKVEREIN in Vienna, which is famous for its hall resonance and unique reverberative sound.

### ■ CHURCH

Reproduces the acoustics of a stone church.

### ■ JAZZ CLUB

Reproduces the acoustics of a jazz club.

### ■ LIVE CONCERT

Reproduces the acoustics of a 300-seat live house.

### ■ STADIUM

Reproduces the feeling of a large open-air stadium.

### ■ SPORTS

Reproduces the feeling of sports broadcasting.

## When the headphones are connected

You can select only from the following sound fields.

### ■ HEADPHONE (2CH)

Press 2CH or A.F.D. Outputs the sound in 2 channel (stereo). Standard 2 channel stereo sources completely bypass the sound field processing and multi channel surround formats are downmixed to 2 channels.

### ■ HEADPHONE (DIRECT)

Press DIRECT. Outputs the analog signals without digital processing by the equalizer.

### ■ HEADPHONE (MULTI 1/MULTI 2)

Press MULTI CH 1/2. Outputs the analog signals input to the MULTI CHANNEL INPUT jacks by downmixing to 2 channels.

**■ HEADPHONE THEATER DCS**

Press MOVIE or MUSIC. Allows you to experience a theater-like environment while listening through a pair of headphones.

**To turn off the surround effect**

Press 2CH, or press A.F.D. to select “A.F.D. AUTO”.

**Enjoying the surround effect at low volume level (NIGHT MODE)**

This function allows you to retain a theater like environment at low volume levels. This function can be used with other sound fields.

When watching a movie late at night, you will be able to hear the dialog clearly even at a low volume level.

**Press NIGHT MODE.**

The NIGHT MODE function is activated.

**Tip**

While this function is on, the BASS, TREBLE, and EFFECT level increase, and “D.RANGE COMP.” is automatically set to “MAX” (page 41).

**Note**

This function cannot be activated when the DIRECT function is activated.

**Listening to the sound without any adjustment**

You can listen to the sound without adjusting the equalizer and surround effect.

**Press DIRECT.**

The equalizer and sound fields are canceled.

**Note**

LIP SYNC (page 37) is not activated when an analog input is selected and the DIRECT function is used.

**Selecting the surround back decoding mode****— SURR BACK DECODING**

This function lets you select the decoding mode for the surround back signals of the multi channel input stream.

By decoding the surround back signal of DVD software (etc.) recorded in Dolby Digital EX, DTS-ES Matrix, DTS-ES Discrete 6.1, etc. format, you can enjoy the surround sound intended by the filmmakers.

**Press SURR BACK DECODING repeatedly to select the surround back decoding mode.**

For details, see “How to select the surround back decoding mode” on page 30.

**Tip**

You can select the surround back decoding mode using “SB DECODING” in the CUSTOMIZE menu (page 36).

---

## How to select the surround back decoding mode

You can select the surround back mode you want according to the input stream.

### When you select “AUTO”

When the input stream contains the 6.1 channel decode flag<sup>a)</sup>, the appropriate decoder is applied to decode the surround back signal.

Input stream	Output channel	Applied surround back decoder
Dolby Digital 5.1	5.1 <sup>e)</sup>	—
Dolby Digital EX <sup>b)</sup>	6.1 <sup>e)</sup>	Matrix decoder for Dolby Digital EX
DTS 5.1	5.1 <sup>e)</sup>	—
DTS-ES Matrix 6.1 <sup>c)</sup>	6.1 <sup>e)</sup>	DTS Matrix decoder
DTS-ES Discrete 6.1 <sup>d)</sup>	6.1 <sup>e)</sup>	DTS Discrete decoder

### When you select “MATRIX”

Dolby Digital EX is applied to decode the surround back signal regardless of the 6.1 channel decode flag<sup>a)</sup> in the input stream. This decoder conforms to the Dolby Digital EX specifications and functions the same as the decoders<sup>f)</sup> used in movie theaters.

Input stream	Output channel	Applied surround back decoder
Dolby Digital 5.1	6.1 <sup>e)</sup>	Matrix decoder for Dolby Digital EX
Dolby Digital EX <sup>b)</sup>	6.1 <sup>e)</sup>	Matrix decoder for Dolby Digital EX
DTS 5.1	6.1 <sup>e)</sup>	Matrix decoder for Dolby Digital EX
DTS-ES Matrix 6.1 <sup>c)</sup>	6.1 <sup>e)</sup>	Matrix decoder for Dolby Digital EX
DTS-ES Discrete 6.1 <sup>d)</sup>	6.1 <sup>e)</sup>	Matrix decoder for Dolby Digital EX

### When you select “OFF”

Surround back decoding is not performed.

The SB DEC indicator lights up when the surround back signal is actually decoded.

- a) 6.1 channel decode flag is the information recorded in software like DVDs.
- b) Dolby Digital DVD software that includes a Surround EX flag. The Dolby Corporation web page can help you distinguish Surround EX films.
- c) Software encoded with a flag to denote it has both Surround EX and 5.1 channel signals.
- d) Software encoded with both 5.1 channel signals and an extension stream designed for returning those signals to 6.1 discrete channels. Discrete 6.1 channel signals are DVD specific signals not used in movie theaters.
- e) When two surround back speakers are connected, the output channel will be 7.1 channels.
- f) This decoder can be used for all 6.1 formats (Dolby Digital EX, DTS-ES Matrix 6.1, DTS-ES Discrete 6.1).

#### Note

There may be no sound from the surround back speaker in Dolby Digital EX mode. Some discs have no Dolby Digital EX flag even though the packages have Dolby Digital EX logos. In this case, select “MATRIX”.

### Assigning the audio input

#### — DIGITAL ASSIGN

You can assign the digital audio inputs to other inputs. This function is convenient in the following cases.

**(Example) When you have two DVD players and no digital audio input jack is available for the second DVD player.**

Connect the first DVD player to the DVD COAXIAL IN jack and connect the second DVD player to the DVD OPTICAL IN jack. Also, connect the analog audio/video output jacks on the second DVD player to the VIDEO 2 INPUT jacks on the amplifier.

Assign “DVD COAX” to DVD and assign “DVD OPT” to VIDEO 2.

- 1** Rotate MAIN MENU to select “CUSTOMIZE”.
- 2** Rotate MENU to select “DIGITAL ASSIGN ?”.
- 3** Press ENTER.
- 4** Rotate MENU to select the digital audio input you want to assign.
- 5** Rotate  $\rightarrow/\leftarrow$  to select the input you want to assign the digital audio input jack selected in step 4.

The input you can assign varies for each audio input. For details, see “Selectable inputs for each digital audio input”.

#### Selectable inputs for each digital audio input

---

##### VIDEO 1 COAX, VIDEO 1 OPT

VIDEO 1, VIDEO 2, VIDEO 3, VIDEO 4, TAPE, TUNER

---

##### VIDEO 5 OPT

VIDEO 5, VIDEO 2, VIDEO 3, VIDEO 4, TAPE, TUNER

---

##### DVD COAX, DVD OPT

DVD, VIDEO 2, VIDEO 3, VIDEO 4, TAPE, TUNER

---

##### LD COAX, LD OPT, LD DD RF

LD, VIDEO 2, VIDEO 3, VIDEO 4, TAPE, TUNER

---

##### TV/SAT COAX, TV/SAT OPT

TV/SAT, VIDEO 2, VIDEO 3, VIDEO 4, TAPE, TUNER

---

##### MD/DAT OPT

MD/DAT, VIDEO 2, VIDEO 3, VIDEO 4, TAPE, TUNER

---

##### CD/SACD COAX, CD/SACD OPT

CD/SACD, VIDEO 2, VIDEO 3, VIDEO 4, TAPE, TUNER

---

#### Notes

- You cannot assign several digital audio inputs to the same input.
- You cannot use the digital audio input with its the original input when it is assigned to another input.
- When you assign the digital audio input, the INPUT MODE setting may change automatically (page 32).

## Switching the audio input mode for digital components

### — INPUT MODE

You can switch the audio input mode for components for which this amplifier has digital audio input jacks.

- 1 Rotate INPUT SELECTOR to select the input.**
- 2 Press INPUT MODE repeatedly to select the audio input mode.**

The selected audio input mode appears in the display.

### Audio input modes

- **AUTO 2CH**  
Gives priority to the digital audio signals input to the DIGITAL COAXIAL jack, DIGITAL OPTICAL jack, and to the AUDIO IN (L/R) jacks in that order. When there are no digital audio signals, the analog audio signals input to the AUDIO IN (L/R) jacks are selected.
- **COAXIAL FIXED**  
Specifies the digital audio signals input to the DIGITAL COAXIAL jack.
- **OPTICAL FIXED**  
Specifies the digital audio signals input to the DIGITAL OPTICAL jack.
- **ANALOG 2CH FIXED**  
Specifies the analog audio signals input to the AUDIO IN (L/R) jacks.

### Notes

- You cannot select the digital audio input assigned to another function with the DIGITAL ASSIGN function (page 31).
- Some of the audio input modes do not appear depending on the input.

## Customizing sound fields

By adjusting the SURR SET UP menu and LEVEL menu, you can customize the sound fields to suit your particular listening situation.

### Note on the displayed items

The setup items you can adjust in each menu vary depending on the sound field. Certain setup parameters may be dimmed in the display. This means that the selected parameter is either unavailable or fixed and unchangeable.

---

### Adjusting the SURR SET UP menu

You can customize the surround effects of the selected sound field. The settings are stored individually for each sound field.

- 1 Start playing a source encoded with multi channel surround effects (DVD, etc.).**
- 2 Rotate MAIN MENU to select “SURR SET UP”.**
- 3 Rotate MENU to select the parameter.**  
For details, see “SURR SET UP menu parameters” below.
- 4 While monitoring the sound, rotate +/- to adjust the selected parameter.**
- 5 Repeat steps 3 and 4 to adjust the other parameters.**

### SURR SET UP menu parameters

#### ■ EFFECT LEVEL XXX% (Effect level)

Initial setting: 100%

Higher settings apply more surround effect. You can adjust from 20% to 120% in 5% steps.

### For advanced SURR SET UP menu adjustments

Use the CUSTOMIZE menu and set “MENU EXPAND” to “ON” to enable advanced adjustments.

For details on “MENU EXPAND”, see page 36.

For details on how to set the items, see page 39.



## Adjusting the LEVEL menu

You can adjust the balance and level of each speaker. These settings are applied to all sound fields.

- 1 Start playing a source encoded with multi channel surround effects (DVD, etc.).**
- 2 Rotate MAIN MENU to select “LEVEL”.**
- 3 Rotate MENU to select the parameter.**  
For details, see “LEVEL menu parameters” below.
- 4 While monitoring the sound, rotate  $\pm$  to adjust the selected parameter.**
- 5 Repeat steps 3 and 4 to adjust the other parameters.**

### LEVEL menu parameters

#### ■ TEST TONE (Test Tone)

Initial setting: OFF

Lets you output the test tone sequentially from each speaker. When set to “AUTO”, the test tone is output from each speaker automatically. When set to “FIX”, you can select which speaker will output the test tone.

#### ■ FRONT L\_I\_R (Front speaker balance)

Initial setting: 0 (BALANCE)

Lets you adjust the balance between front left and right speakers. You can adjust from  $-8$  dB to  $+8$  dB in 0.5 dB steps.

#### ■ CENTER XXX.X dB (Center speaker level)

#### ■ SURROUND L XXX.X dB (Surround speaker (L) level)

#### ■ SURROUND R XXX.X dB (Surround speaker (R) level)

#### ■ SURR BACK XXX.X dB (Surround back speaker level)\*

#### ■ SURR BACK L XXX.X dB (Surround back (L) level)\*\*

#### ■ SURR BACK R XXX.X dB (Surround back (R) level)\*\*

#### ■ SUB WOOFER XXX.X dB (Sub woofer level)

Initial setting: 0 dB

You can adjust from  $-20$  dB to  $+10$  dB in 0.5 dB steps.

#### ■ MULTI CH 1 SW XXX dB (Multi channel 1 sub woofer level)

#### ■ MULTI CH 2 SW XXX dB (Multi channel 2 sub woofer level)

Initial setting: 0 dB

Lets you increase the level of the MULTI CHANNEL INPUT 1/MULTI CHANNEL INPUT 2 sub woofer channel by  $+10$  dB. This adjustment may be necessary when connecting a DVD player to the MULTI CHANNEL INPUT 1/MULTI CHANNEL INPUT 2 jacks. The sub woofer level from DVD players is 10 dB lower than Super Audio CD players.

\* Only when the surround back speaker is set to “SINGLE” in the SPEAKER SET UP menu (page 19).

\*\* Only when the surround back speaker is set to “DUAL” in the SPEAKER SET UP menu (page 19).

#### Note

When one of the following sound fields are selected, no sound is output from the sub woofer if all the speakers are set to “LARGE” in the SPEAKER SET UP menu. However, the sound will be output from the sub woofer if the digital input signal contains LFE (Low Frequency Effect) signals, or if the front or surround speakers are set to “SMALL”.

- D.CONCERT HALL A
- D.CONCERT HALL B
- CHURCH
- JAZZ CLUB
- LIVE CONCERT
- STADIUM
- SPORTS

### For advanced LEVEL menu adjustments

Use the CUSTOMIZE menu and set “MENU EXPAND” to “ON” to enable advanced adjustments.

For details on “MENU EXPAND”, see page 36.  
For details on how to set the items, see page 40.

### Resetting sound fields to the initial settings

- 1 Press  $I/\phi$  to turn off the power.**
- 2 While holding down MUSIC, press  $I/\phi$ .**

“S.F. Initialize” appears in the display and all sound fields are reset to the initial setting.

## Adjusting the equalizer

You can adjust the tonal quality (bass, midrange, treble level) of each speaker using the EQUALIZER menu.

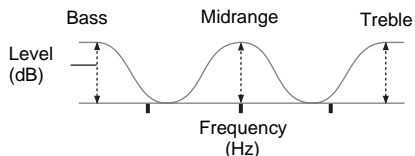

You can store up to 5 different equalizer settings in the equalizer bank (EQ BANK [1] – [5]) and apply them.

- 1** Start playing a source encoded with multi channel surround effects (DVD, etc.).
- 2** Rotate MAIN MENU to select “EQUALIZER”.
- 3** Rotate MENU to select “EQ BANK”.
- 4** Rotate  $-/+$  to select the equalizer bank you want to adjust (EQ BANK [1] – [5]).
- 5** Rotate MENU to select the parameter.  
For details, see “EQUALIZER menu parameters” below.
- 6** While monitoring the sound, rotate  $-/+$  to adjust the selected parameter.
- 7** Repeat steps 5 and 6 to adjust the other items.

### EQUALIZER menu parameters

#### ■ EQ BANK (Equalizer bank selection)

Lets you select the equalizer bank ([1] – [5]). When you select “OFF”, the equalizer is cancelled.

#### ■ FRONT BASS XXX dB (Front speaker bass level)

#### ■ FRONT TREBLE XXX dB (Front speaker treble level)

#### ■ CENTER BASS XXX dB (Center speaker bass level)

#### ■ CENTER MID XXX dB (Center speaker midrange level)

#### ■ CENTER TREBLE XXX dB (Center speaker treble level)

■ **SURR/SB BASS XXX dB**  
(Surround/surround back speaker bass level)

■ **SURR/SB TRE. XXX dB**  
(Surround/surround back speaker treble level)

Initial setting: 0 dB

You can adjust from -10 dB to +10 dB in 1 dB steps.

■ **PRESET X CLEAR**  
(Equalizer bank clear)

You can reset the adjusted equalizer settings to the initial setting. For details, see “Clearing stored equalizer settings”.

#### Tip

You can adjust the front speaker bass and treble level with BASS control and TREBLE control.

### To apply the stored equalizer

- 1 Rotate MAIN MENU to select “EQUALIZER”.
- 2 Rotate MENU to select “EQ BANK”.
- 3 Rotate -/+ to select “EQ BANK [1] – [5]”.

### To turn off the equalizer

Select “EQ BANK [OFF]”.

### Clearing stored equalizer settings

- 1 Rotate MAIN MENU to select “EQUALIZER”.
- 2 Rotate MENU to select “EQ BANK”.
- 3 Rotate +/- to select the equalizer (EQ BANK [1] – [5]) you want to clear.
- 4 Rotate MENU to select “PRESET X CLEAR”.  
“X” is the number of the selected equalizer bank.
- 5 Rotate -/+ to select “YES”, then press ENTER.  
“Are you sure?” appears in the display.
- 6 Rotate -/+ to select “YES”, then press ENTER.  
“PRESET X CLEARED!” appears in the display and the adjusted contents of the selected equalizer bank are cleared.

### For advanced EQUALIZER menu adjustments

Use the CUSTOMIZE menu and set “MENU EXPAND” to “ON” to enable advanced adjustments.

For details on “MENU EXPAND”, see page 36.

For details on how to set the items, see page 41.

## Advanced settings

### Using the CUSTOMIZE menu to adjust the amplifier

You can adjust various amplifier settings using the CUSTOMIZE menu.

- 1 Rotate MAIN MENU to select “CUSTOMIZE”.**
- 2 Rotate MENU to select the parameter.**  
For details, see “CUSTOMIZE menu parameters” below.
- 3 Rotate  $-/+$  to adjust the selected parameter.**
- 4 Repeat steps 2 and 3 to adjust the other items.**

### CUSTOMIZE menu parameters

The initial setting is underlined.

#### ■ MENU EXPAND (Menu expanding)

- ON

The advanced parameters for the SPEAKER SET UP, SURR SET UP and LEVEL menus are displayed and can be adjusted.

For details on each setup item, see pages 18, 32, 33 and the following pages.

- OFF

The advanced parameters are not displayed.

#### ■ DTS 96/24 DEC. (DTS 96/24 decoding mode)

- AUTO

When a DTS 96/24 signal is input, it is played back at 96 kHz sampling frequencies.

- OFF

Even when a DTS 96/24 signal is input, it is played back at 48 kHz sampling frequencies.

#### Note

This parameter is valid only in the A.F.D. mode (page 26). In other sound fields, this parameter is always set to “OFF”.

#### ■ SB DECODING (Surround back decoding mode)

You can use the CUSTOMIZE menu to set the surround back decoding mode. See page 29.

- AUTO
- MATRIX
- OFF

#### ■ i POWER (i.LINK power management)

- AUTO

Lets you turn off the power of the unnecessary i.LINK circuits automatically. You can enjoy high quality digital or analog audio without the influence of the i.LINK circuits. When set to “AUTO”, it takes some time to output the sound. See page 22 for a note on switching the input when set to “AUTO”.

- EVER ON

Lets you keep the power of the i.LINK circuits.

Select if you do not like the time lag that occurs with the “AUTO” setting.

#### ■ H.A.T.S. (H.A.T.S. (High quality digital Audio Transmission System) function)

- ON

The digital audio signals input from the i.LINK component is stored in the buffer temporarily, then retrieved from the buffer and converted to analog audio signals at the proper timing. The sound quality is enhanced because there is no jitter (timing gaps when reading signals) when transmitting the digital audio signals. If you do not want to use this function, select “OFF”.

- OFF

This function is not activated.

#### Note

It takes some time to output the sound after the playback operation is performed on the connected component (ex., press PLAY button, press STOP button, press PAUSE button) due to limitations of the H.A.T.S. system. The time lag depends on the sound source.

#### ■ DSD-SW SWAP (DSD-SW swapping)

On some multi channel Super Audio CDs, the 6th channel is not for the sub woofer, but contains some other sound (such as reverberation from the ceiling, etc.).

This item lets you switch the output of the 6th channel signals from the SUB WOOFER PRE OUT to the SURROUND BACK terminals.

- ON

6th channel DSD signals input through the i.LINK connection and SUB WOOFER channel signals input through the MULTI CHANNEL IN 1 or MULTI CHANNEL IN 2 terminals are output from the SURROUND BACK terminals, and no sound is output from the SUB WOOFER PRE OUT.

- OFF

Sound is output from the SUB WOOFER PRE OUT as normal.

**Note**

This function does not work when “SURR BACK SP” in the SPEAKER SET UP menu is set to “NO” (page 19).

**■ LIP SYNC (Time alignment)**

Initial setting: 0 ms

Lets you delay the output of audio to adjust the gap between video and audio. You can adjust from 0 ms to 200 ms in 10 ms steps.

This function is not available in the following cases:

- When analog input is selected and DIRECT function is used.
- When MULTI CH IN 1/2 is selected.
- When DSD signal is input from the i.LINK component.

**■ DC PHASE L. (DC Phase Linearizer)**

Lets you approximate the low frequency phase characteristics to a traditional analog amplifier.

## • OFF

Phase correction is not performed.

• LOW-A, STD-A, HIGH-A, LOW-B, STD-B, HIGH-B

The bandwidth range of the phase correction increases in the order of “LOW”, “STD”, “HIGH”. “B” parameter phase correction provides more enhanced bass characteristics.

**■ MIX SCALING (Downmix scaling)**

Lets you adjust the downmix scaling processing for center and sub woofer channels. This parameter can be set only when the center speaker is set to “MIX”.

• ON

The downmix scaling is performed.

## • OFF

The downmix scaling is not performed so that the sound quality is not deteriorated. If the sound is heard like a noise at the high input level, set to “ON”.

**■ S.FIELD LINK (Sound field link)**• ON

Lets you apply the last selected sound field to an input whenever it is selected. For example, if you select STADIUM for the CD/SACD input, then change to a different input and return to CD/SACD, STADIUM will automatically be applied again.

## • OFF

Sound field link is not activated.

**■ DEC. PRIORITY (Digital audio input decoding priority)**

Lets you specify the input mode for the digital signal input to the DIGITAL IN jacks.

The initial setting is “AUTO” for VIDEO 1, VIDEO 2, VIDEO 3, VIDEO 4, VIDEO 5, LD, TV/SAT, TAPE, TUNER, PHONO and i.LINK, and “PCM” for DVD,

CD/SACD and MD/DAT. You can use DECODE PRIORITY on the front panel.

## • AUTO

Automatically switches the input mode between DTS, Dolby Digital, or PCM.

## • PCM

PCM signals are given priority (to prevent interruption when playback starts). When set to “AUTO” and the sound from the digital audio jacks (for CD, etc.) is interrupted when playback starts, set to “PCM”. However, when other signals are input, there may be no sound depending on the format. In this case, set to “AUTO”.

**■ 2 WAY REMOTE (2 way remote control system)**• ON

Lets you turn on the 2 way remote control system. Normally, select “ON”.

## • OFF

Lets you turn off the 2 way remote control system. When you use another amplifier, etc. that is also compatible with the 2 way remote control system, together with this amplifier, select the component for which you use the 2 way remote control system. Then set the 2 way remote control system for the component to “ON”. For other components, set the 2 way remote control system to “OFF”.

**■ COLOR SYSTEM (OSD color system) (Models of area code CEL only)**

Lets you select the color system.

## • NTSC

• PAL**■ OSD H.POSITION (OSD horizontal position)**

Initial setting: 4

Lets you adjust the position of the on-screen display horizontally. You can adjust from 0 to 64.

**■ OSD V.POSITION (OSD vertical position)**

Initial setting: 4

Lets you adjust the position of the on-screen display vertically. You can adjust from 0 to 32.

**■ UP YUV HUE (Video hue level)**

Initial setting: 4

Lets you adjust the hue of the images when you upconvert the video or S-video signals to component video signals. You can adjust from 1 to 7.

**■ UP YUV SHARPNESS (Video sharpness level)**

Initial setting: 4

Lets you adjust the sharpness of the images when you upconvert the video or S-video signals to component video signals. You can adjust from 1 to 5.

■ **UP YUV COLOR (Video chroma level)**

Initial setting: 4

Lets you adjust the chroma of the images when you upconvert the video or S-video signals to component video signals. You can adjust from 1 to 7.

■ **DIGITAL ASSIGN ? (Digital audio input assignment)**

Lets you assign the digital audio input to other input. For details, see "Assigning the audio input" on page 31.

■ **USER PRESET MEM.? (User preset memory)**

Lets you store the adjusted sound field settings, etc. For details, see "Storing the adjusted settings" on page 42.

■ **NAME IN? (Naming inputs)**

Lets you set the name of inputs selected with INPUT SELECTOR. For details, see "Naming inputs" on page 44.

---

## Advanced SPEAKER SET UP menu parameters

When "MENU EXPAND" is set to "ON", all of the following parameters are displayed and adjustable.

See page 18 for the SPEAKER SET UP menu adjustments. Initial settings are underlined.

## All SPEAKER SET UP menu parameters

---

SP EASY SET UP

---

SPEAKER PATTERN

---

SUB WOOFER

---

FRONT SP

---

CENTER SP

---

SURROUND SP-A

---

SURROUND SP-B

---

SURR BACK SP

---

FRONT XXX meter

---

CENTER XXX meter

---

SURROUND-A XXX meter

---

SURROUND-B XXX meter

---

SURR BACK XXX meter

---

SUB WOOFER XXX meter

---

DISTANCE UNIT\*

---

SP-A POSI\*

---

SP-B POSI\*

---

SP CROSSOVER > XXX Hz\*

---

OUTPUT\*

---

\* Adjustable only when "MENU EXPAND" is set to "ON".

■ **DISTANCE UNIT (Distance unit)**

Lets you select the unit of measure for setting distances.

- feet

The distance is displayed in feet.

- meter

The distance is displayed in meters.

■ **SP-A POSI (Surround speaker-A position)\***

■ **SP-B POSI (Surround speaker-B position)\***

Lets you specify the location of your surround speakers for proper implementation of the surround effects in the Cinema Studio EX modes (page 27).

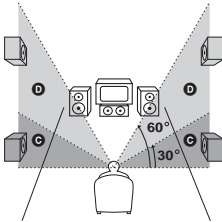
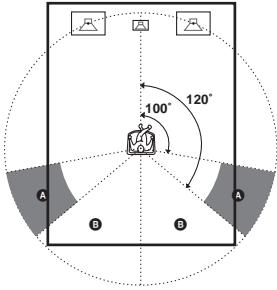

- **SIDE/LOW**  
Select if the location of your surround speakers corresponds to section **A** and **C**.
- **SIDE/HIGH**  
Select if the location of your surround speakers corresponds to section **A** and **D**.
- **BEHD/LOW**  
Select if the location of your surround speakers corresponds to section **B** and **C**.
- **BEHD/HIGH**  
Select if the location of your surround speakers corresponds to section **B** and **D**.

\* This setup item is not available when the surround speaker parameter is set to “NO” (page 19).

### Tip

Surround speaker position is designed specifically for implementation of the Cinema Studio EX modes. For other sound fields, speaker position is not so critical. Those sound fields were designed under the premise that the surround speakers would be located behind the listening position, but presentation remains fairly consistent even with the surround speakers positioned at a rather wide angle. However, if the speakers are pointing toward the listener from the immediate left and right of the listening position, the surround effects becomes unclear unless set to “SIDE”. Nevertheless, each listening environment has many variables, like wall reflections, and you may obtain better results using “BEHD” if your speakers are located high above the listening position, even if they are to the immediate left and right.

Therefore, although it may result in a setting contrary to the above explanation, we recommend that you playback multi channel surround encoded software and select the setting that provides a good sense of spaciousness and that best succeeds in forming a cohesive space between the surround sound from the surround speakers and the sound of the front speakers. If you are not sure which sounds best, select “BEHD” and then use the speaker distance parameter and speaker level adjustments to obtain proper balance.

### ■ SP CROSSOVER > XXX Hz (Speaker crossover frequency)

Initial setting: 100 Hz

Lets you set the bass crossover frequency of speakers set to “SMALL” in the SPEAKER SET UP menu. You can adjust from 40 Hz to 160 Hz in 10 Hz steps.

### ■ OUTPUT (Preout downmixing)

- **ALL ON**  
Lets you output the sound from both SPEAKERS and PREOUT jacks. (All downmixing is performed by DSP.)
- **FRONT SP OFF**  
Lets you turn off the sound output from front speakers and perform the analog downmixing. Select this when you use this amplifier as a preamp for front speakers only.
- **PREOUT ONLY**  
Lets you output the sound from PREOUT jacks and not output from SPEAKERS jacks (analog downmixing is performed). Select this when you use this amplifier as a full-channel preamp.

## Advanced SURR SET UP menu parameters

When “MENU EXPAND” is set to “ON”, all of the following parameters are displayed and adjustable.

See page 32 for the SURR SET UP menu adjustments. Initial settings are underlined.

## All SURR SET UP menu parameters

---

EFFECT LEVEL

---

C. WIDTH L\_C\_R\*

---

DIMENSION F\_I\_S\*

---

PANORAMA MODE\*

---

FRONT REVERB\*

---

SCREEN DEPTH\*

---

VIR.SPEAKERS\*

---

A.F.D. 2CH SW\*

---

\* Adjustable only when "MENU EXPAND" is set to "ON".

### ■ C. WIDTH L\_C\_R (Center width control)

Initial setting: (3)

Lets you perform further adjustments for Dolby Pro Logic II Music mode decoding. You can set this parameter only when A.F.D. mode is set to "PRO LOGIC II MUSIC" (page 26).

You can adjust the distribution of the center channel signal, generated through the Dolby Pro Logic II decoding, to the L/R speakers.

### ■ DIMENSION F\_I\_S (Dimension control)

Initial setting: midpoint (0)

Lets you perform further adjustments for Dolby Pro Logic II Music mode decoding. You can set this parameter only when A.F.D. mode is set to "PRO LOGIC II MUSIC" (page 26).

You can adjust the difference between the front channels and the surround channels.

### ■ PANORAMA MODE (Panorama mode)

Lets you perform further adjustments for Dolby Pro Logic II Music mode decoding. You can set this parameter only when A.F.D. mode is set to "PRO LOGIC II MUSIC" (page 26).

- ON

Lets you enjoy the surround sound by spreading the sound field of front speakers to the left and right of the listening position (panorama mode).

- OFF

Panorama mode is not activated.

### ■ FRONT REVERB (Front reverberation)

This parameter is especially for "D.CONCERT HALL A/B" (page 28). This parameter lets you adjust the amount of reverberations to add to the front signals according to the original reverberations in the source.

- STD

Normally, select "STD".

- WET

Select to increase front reverberations.

### ■ SCREEN DEPTH (Screen depth)

Lets you create the sensation that the sound of the front speakers comes from inside the screen in your listening room, like theatres.

- ON

Lets you create the sensation that the sound comes from a very large screen with a great amount of screen depth.

- OFF

This function is not activated.

### ■ VIR.SPEAKERS (Virtual speakers)

This parameter is especially for the Cinema Studio EX modes (page 27).

- ON

The virtual speakers are created.

- OFF

The virtual speakers are not created.

### Note

The setting of "SCREEN DEPTH" and "VIR.SPEAKERS" are not linked with sound fields.

### ■ A.F.D. 2CH SW (Creating, low frequency signals)

- CREATE

Lets you create low frequency signals for output to the subwoofer when "A.F.D. AUTO" is selected.

- OFF

Low frequency signals are not created.

---

## Advanced LEVEL menu parameters

When "MENU EXPAND" is set to "ON", all of the following parameters are displayed and adjustable.

See page 33 for the LEVEL menu adjustments. Initial settings are underlined.



## All LEVEL menu parameters

TEST TONE
PHASE NOISE <sup>a)</sup>
PHASE AUDIO <sup>a)</sup>
FRONT L_I_R
CENTER XXX.X dB
SURROUND L XXX.X dB
SURROUND R XXX.X dB
SURR BACK XXX.X dB <sup>b)</sup>
SURR BACK L XXX.X dB <sup>c)</sup>
SURR BACK R XXX.X dB <sup>c)</sup>
SUB WOOFER XXX.X dB
SUB WOOFER TRIM X.X dB <sup>a)</sup>
CENTER TRIM X.X dB <sup>a)</sup>
MULTI CH 1 SW XXX dB
MULTI CH 2 SW XXX dB
D.RANGE COMP. <sup>a)</sup>

a) Adjustable only when “MENU EXPAND” is set to “ON”.

b) When surround back speaker is set to “SINGLE” (page 19).

c) When surround back speaker is set to “DUAL” (page 19).

### ■ PHASE NOISE (Phase noise)

Initial setting: OFF

Lets you output the test tone sequentially from adjacent speakers.

### ■ PHASE AUDIO (Phase audio)

Initial setting: OFF

Lets you output the front 2 channel source sound (instead of the test tone) sequentially from adjacent speakers. When i.LINK input is selected, this function is unavailable.

### ■ SUB WOOFER TRIM (Sub woofer trim adjustment)

Initial setting: 0 dB

Lets you adjust the level of the sub woofer when the signals of sub woofer channel is input. Use this parameter to adjust the sub woofer level when connecting headphones or when the sub woofer is not connected. You can adjust from -6 dB to +6 dB in 1 dB steps.

### ■ CENTER TRIM X.X dB (Center speaker trim adjustment)

Initial setting: 0 dB

Lets you adjust the output of the center speaker. Increase this parameter if you are having trouble

hearing the dialogue. If you did not install a center speaker, this parameter adjusts the level of the center channel as it is mixed with the sound of the front speakers. You can adjust from -3 dB to +3 dB in 0.5 dB steps.

### Notes

- “SUB WOOFER TRIM” and “CENTER TRIM” can be adjusted only when the center speaker is set to “MIX”.
- “SUB WOOFER TRIM” and “CENTER TRIM” do not function for Super Audio CD signals from an i.LINK component, MULTI CH IN signals, or DTS 96/24 decoded signals.

### ■ D.RANGE COMP. (Dynamic range compressor)

Lets you compress the dynamic range of the sound track. This may be useful when you want to watch movies at low volumes late at night.

#### • OFF

The dynamic range is not compressed.

#### • STD

The dynamic range is compressed as intended by the recording engineer.

#### • MAX

The dynamic range is compressed dramatically.

### Tip

Dynamic range compressor lets you compress the dynamic range of the soundtrack based on the dynamic range information included in the Dolby Digital signal. “STD” is the standard setting, but it only enacts light compression.

Therefore, we recommend using the “MAX” setting. This greatly compresses the dynamic range and lets you view movies late at night at low volumes. Unlike analog limiters, the levels are predetermined and provide a very natural compression.

### Note

Dynamic range compression is possible with Dolby Digital sources only.

## Advanced EQUALIZER menu parameters

When “MENU EXPAND” is set to “ON”, all of the following parameters are displayed and adjustable.

See page 34 for the EQUALIZER menu adjustments. Initial settings are underlined.

## All EQUALIZER menu parameters

EQ BANK

FRONT BASS XXX dB

FRONT BASS XXX Hz\*

FRONT TREBLE XXX dB

FRONT TREBLE XXX Hz\*

CENTER BASS XXX dB

CENTER BASS XXX Hz\*

CENTER MID XXX dB

CENTER MID XXX Hz\*

CENTER TREBLE XXX dB

CENTER TREBLE XXX Hz\*

SURR/SB BASS XXX dB

SURR/SB BASS XXX Hz\*

SURR/SB TRE. XXX dB

SURR/SB TRE. XXX Hz\*

PRESET X CLEAR

\* Adjustable only when “MENU EXPAND” is set to “ON”.

### ■ FRONT BASS XXX Hz (Front speaker bass frequency)

Initial setting: 500 Hz

You can adjust either to 250 Hz or to 500 Hz.

### ■ FRONT TREBLE XXX Hz (Front speaker treble frequency)

Initial setting: 2.2 kHz

You can adjust either to 2.2 kHz or to 4.3 kHz.

### ■ CENTER BASS XXX Hz (Center speaker bass frequency)

Initial setting: 500 Hz

You can adjust either to 250 Hz or to 500 Hz.

### ■ CENTER MID XXX Hz (Center speaker midrange frequency)

Initial setting: 1 kHz

You can adjust from 100 Hz to 10 kHz in 5 steps.

### ■ CENTER TREBLE XXX Hz (Center speaker treble frequency)

Initial setting: 2.2 kHz

You can adjust either to 2.2 kHz or to 4.3 kHz.

### ■ SURR/SB BASS XXX Hz (Surround/surround back speaker bass frequency)

Initial setting: 500 Hz

You can adjust either to 250 Hz or to 500 Hz.

### ■ SURR/SB TRE. XXX Hz (Surround/surround back speaker treble frequency)

Initial setting: 2.2 kHz

You can adjust either to 2.2 kHz or to 4.3 kHz.

## Storing the adjusted settings

### — USER PRESET

You can store the adjusted sound field settings, etc. as user presets. You can store up to 3 user presets and easily apply them.

## Setting the USER PRESET

- 1 Adjust the sound field, etc.**  
For the settings you can store, see “Settings that can be stored in USER PRESET”.
- 2 Rotate MAIN MENU to select “CUSTOMIZE”.**
- 3 Rotate MENU to select “USER PRESET MEM.?”.**
- 4 Rotate +/- to select the USER PRESET number.**
- 5 Press ENTER.**
- 6 To store other settings, repeat steps 1 to 5.**

## Settings that can be stored in USER PRESET

- Input selected by the INPUT SELECTOR
- INPUT MODE setting
- Selected sound field
- MULTI CH IN setting
- DIRECT setting
- NIGHT MODE setting
- C.WIDTH setting
- DIMENSION setting
- PANORAMA MODE setting
- EFFECT LEVEL setting
- FRONT REVERB setting
- SCREEN DEPTH setting
- VIR.SPEAKERS setting

---

## To use the USER PRESET

- 1** Press **USER PRESET** repeatedly to select the **USER PRESET** you want.
- 2** Press **ENTER**.

### Note

If the **DIGITAL ASSIGN** setting is changed after you store a **USER PRESET** and if the stored **INPUT MODE** setting cannot be used, a selectable setting is applied automatically.

Example:

- 1) Use the **DIGITAL ASSIGN** function to assign "DVD OPT" to "TAPE".
- 2) Set the **INPUT MODE** of **TAPE** to "AUTO 2CH" or "OPTICAL FIXED", then store this setting in a **USER PRESET**.
- 3) Use the **DIGITAL ASSIGN** function to assign "DVD OPT" to "DVD".
- 4) Select the **USER PRESET** stored in example 2. The **INPUT MODE** of **TAPE** is automatically set to "ANALOG 2CH FIXED". You cannot select "AUTO 2CH" or "OPTICAL FIXED".

## Other Operations

### Naming inputs

You can enter a name of up to 8 characters for inputs selected with INPUT SELECTOR, and display it in the amplifier's display.

**1 Rotate INPUT SELECTOR to select an input you want to create an index name for.**

**2 Rotate MAIN MENU to select "CUSTOMIZE".**

**3 Rotate MENU to select "NAME IN?".**

**4 Press ENTER or rotate -/+.**

The cursor flashes and you can select a character.

**5 Use MENU and -/+ to create an index name.**

Rotate -/+ to select a character, then rotate MENU to move the cursor to the next position.

#### Tips

- You can select the character type as follows by rotating -/+.  
Alphabet (upper case) → Numbers → Symbols
- To enter a blank space, rotate -/+ until a blank space appears in the display.
- If you make a mistake, rotate MENU until the character you want to change flashes, then rotate -/+ to select the correct character.

**6 Press ENTER.**

The entered name is registered.

**7 To index other inputs, repeat steps 1 to 6.**

## Using the Sleep Timer

You can set the amplifier to turn off automatically at a specified time.

**Press SLEEP repeatedly while the power is on.**

Each time you select or press SLEEP, the display changes cyclically as follows:  
2:00:00 → 1:30:00 → 1:00:00 → 0:30:00 → OFF

While using Sleep Timer, "SLEEP" lights up in the display.

#### Tip

To check the remaining time before the amplifier turns off, press SLEEP while the power is on. The remaining time appears in the display.

## Selecting the speaker system

This amplifier allows you to switch between 3 different surround speaker configurations (A, B, and A+B). There are two sets of surround speaker terminals (A and B). The SPEAKERS SURROUND A terminals are for standard operation with up to 7.1 channels. Use the SPEAKERS SURROUND B terminals to connect additional surround speakers for use in either a separate 5.1 channel system (independent from the 7.1 channel system), or as additional speakers to make the 7.1 channel system into a 9.1 channel system.

### Using only the speakers connected to the SPEAKERS SURROUND A terminals

This is a standard speaker system for use with movies and Super Audio CDs.

### Using the speakers connected to the SPEAKERS SURROUND B terminals

You can create two separate surround systems, a 7.1 channel system for movies and a 5.1 channel system for Super Audio CDs. In this case, connect the surround speakers for movies to the SPEAKERS SURROUND A terminals and connect the surround speakers for music to the SPEAKERS SURROUND B terminals. This is useful if you mainly listen to Super Audio CDs, but also want to enjoy a theater-like sound stage for movies.

## Selecting the front speaker system

Set the SPEAKERS FRONT switch according to the front speakers you want to drive.

Set to	To select
A	The speakers connected to the SPEAKERS FRONT A terminals.
B	The speakers connected to the SPEAKERS FRONT B terminals.
A+B*	The speakers connected to both the SPEAKERS FRONT A and SPEAKERS FRONT B terminals (parallel connection).

Set to	To select
OFF**	No speaker output. (All the sound output from SPEAKERS and PREOUT jacks are turned off.)

- \* When the IMPEDANCE SELECTOR is set to “8Ω”, connect speakers with a nominal impedance of 16 ohm or higher. When the IMPEDANCE SELECTOR is set to “4Ω”, connect the speakers with a nominal impedance of 8 ohms or higher.
- \*\* When you want to turn off the sound output from SPEAKERS jacks while turning on the sound output from PREOUT jacks, set the SPEAKERS FRONT switch to “A”, “B” or “A+B”, then set “OUTPUT” in the SPEAKER SET UP menu to “PREOUT ONLY” (page 39).

## Selecting the surround speaker system

Set the SPEAKERS SURROUND switch according to the surround speakers you want to drive.

Set to	To select
A	The speakers connected to the SPEAKERS SURROUND A terminals (7.1 channel).
B	The speakers connected to the SPEAKERS SURROUND B terminals (5.1 channel). No sound is output from the surround back speakers.
A+B*	The speakers connected to both the SPEAKERS SURROUND A and SPEAKERS SURROUND B terminals (9.1 channel). When this setting is selected, the parameters set for surround speaker-A in SPEAKER SET UP are also set for surround speaker-B.

- \* When the IMPEDANCE SELECTOR is set to “8Ω”, connect speakers with a nominal impedance of 16 ohm or higher. When the IMPEDANCE SELECTOR is set to “4Ω”, connect the speakers with a nominal impedance of 8 ohms or higher.

### Notes

- The settings for surround speakers (page 19) can be set separately for the surround speakers connected to SPEAKERS SURROUND A and SPEAKERS SURROUND B terminals.

- Before setting the surround speakers, select the surround speaker system you use.

## Recording

Before you begin, make sure you have connected all components properly.

### Recording on an audio tape or MiniDisc

You can record on a MiniDisc or cassette tape using the amplifier. See the operating instructions of your cassette deck or MD deck if you need help.

**1 Select the component to be recorded.**

**2 Prepare the component for playing.**

For example, insert a CD into the CD player.

**3 Insert a blank tape or MD into the recording deck and adjust the recording level, if necessary.**

**4 Press REC OUT SELECTOR +/- repeatedly to select the input (component for playing).**

REC OUT SELECTOR +/- are for analog output only. Digital output is available for SOURCE (current input) only. You can not select "i.LINK".

**5 Start recording on the recording deck, then start playback on the playback component.**

#### Notes

- You cannot record a digital audio signal using a component connected to the analog TAPE OUT or MD/DAT OUT jacks. To record a digital audio signal, connect a digital component to the MD/DAT OPTICAL OUT jacks.
- Sound adjustments do not affect the signal output from the TAPE OUT or MD/DAT OUT jacks.
- The signals input to the MULTI CHANNEL INPUT jacks are not output from the TAPE OUT or MD/DAT OUT jacks even when MULTI CH IN is being used. The analog audio signals of the current or previously used input are output.
- When "OFF" is selected with REC OUT SELECTOR +/-, no sound is output from TAPE OUT or MD/DAT OUT jacks.

---

## Recording on a video tape

You can record from a VCR, a TV, or an LD player using the amplifier. You can also add audio from a variety of audio sources when editing a video tape. See the operating instructions of your VCR if you need help.

- 1 Select the program source to be recorded.**
- 2 Prepare the component for playing.**

For example, insert the laser disc you want to record into the LD player.
- 3 Insert a blank video tape into the VCR (VIDEO 1, VIDEO 2 or VIDEO 3) for recording.**
- 4 Press REC OUT SELECTOR +/- repeatedly to select the input (component for playing).**
- 5 Start recording on the recording VCR, then start playing the video tape or laser disc you want to record.**

### Tip

You can record the sound from any audio source onto a video tape while copying from a video tape or laser disc. Locate the point where you want to start recording from another audio source, select the program source, then start playback. The audio from that source will be recorded onto the audio track of the video tape instead of the audio from the original medium. To resume audio recording from the original medium, select the video source again.

### Notes

- The analog audio signals of the current input are output from the VIDEO 1 OUT, VIDEO 2 OUT, or VIDEO 3 OUT jacks.
- You cannot record a digital audio signal using a component connected to the analog VIDEO 1 OUT, VIDEO 2 OUT or VIDEO 3 OUT jacks. To record a digital audio signal, connect a digital component to the VIDEO 1 OPTICAL OUT jack. Note that only the digitally input signal is output from the VIDEO 1 OPTICAL OUT jack.
- Make sure to make both digital and analog connections to the TV/SAT or DVD inputs. Analog recording is not possible if you make only digital connections.
- Some sources contain copy guards to prevent recording. In this case, you may not be able to record from the sources.

- The signals input to the MULTI CHANNEL IN jacks are not output from VIDEO 1 OUT, VIDEO 2 OUT, or VIDEO 3 OUT jacks even when MULTI CH IN is being used. The analog audio signals of the current or previously used input are output.

# CONTROL A1II Control System

The CONTROL A1II Control System was designed to simplify the operation of audio systems composed of separate Sony components. CONTROL A1II connections provide a path for the transmission of control signals which enable automatic operation and control features usually associated with integrated systems. Currently, CONTROL A1II connections between a Sony CD player, amplifier (receiver), MD deck and cassette deck provide automatic function selection.

## Note

Do not operate a 2 way remote control unit when the CONTROL A1II jacks are connected via a PC interface kit to a personal computer running "MD Editor" or similar application. Also, do not operate the connected component in a manner contrary to the functions of the application, as this may cause the application to operate incorrectly.

## CONTROL A1II and CONTROL A1 compatibility

The CONTROL A1 control system has been updated to the CONTROL A1II which is the standard system in the Sony 300 disc CD changer and other recent Sony components. Components with CONTROL A1 jacks are compatible with components with CONTROL A1II, and can be connected to each other. Basically, the majority of the functions available with the CONTROL A1 control system will be available with the CONTROL A1II control system.

However, when making connections between components with CONTROL A1 jacks and components with CONTROL A1II jacks, the number of functions that can be controlled may be limited depending on the component. For detailed information, refer to the operating instructions supplied with the component(s).

## If you have a Sony CD changer with a COMMAND MODE selector

If your CD changer's COMMAND MODE selector can be set to CD 1, CD 2, or CD 3, be sure to set the command mode to "CD 1" and connect the changer to the CD jacks on the amplifier (receiver).

If, however, you have a Sony CD changer with VIDEO OUT jacks, set the command mode to "CD 2" and connect the changer to the VIDEO 2 jacks on the amplifier (receiver).

## Connections

You can connect up to 10 CONTROL A1II compatible components in any order. However, you can connect only one of each type of component (i.e., 1 CD player, 1 MD deck, 1 tape deck and 1 amplifier).

(You may be able to connect more than one CD player or MD deck, depending on the model. Refer to the operating instructions supplied with the respective component for details.)

Example

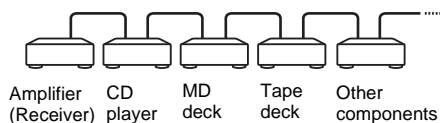

In the CONTROL A1II control system, the control signals flow both ways, so there is no distinction of IN and OUT jacks. If a component has more than one CONTROL A1II jack, you can use either one, or connect different components to each jack.

Some CONTROL A1 compatible components are supplied with a connecting cord as an accessory. In this case, use the connecting cord for your connection.

When using a commercially available cord, use a monaural (2P) mini-plug cord less than 2 meters long, with no resistance.

## Basic Functions

The input selector on the amplifier automatically switches to the correct input when you press the play button on one of the connected components (Auto input selection). The CONTROL A1II functions will operate as long as the component you want to operate is turned on, even if all of the other connected components are not turned on.

## Note

When recording, do not play any components other than the recording source. It will cause the automatic input selection to operate.



## i.LINK connection

If you have the i.LINK component SCD-XA9000ES, connect to this amplifier with an i.LINK cable (supplied with SCD-XA9000ES). This amplifier is only compatible with i.LINK connections to the SCD-XA9000ES. i.LINK connections to SCD-XA9000ES through other components, and i.LINK connections to other component are not guaranteed.

### Notes

- If a metal object should fall into the i.LINK jack, short-circuiting may occur and damage the components.
- Be sure to insert the plug firmly to prevent malfunction.
- For details about compatible signals, see page 54. This amplifier cannot process incompatible signals such as DV, MICROMV, or MPEG-TS. Some i.LINK components conform to copy protection technology standards and handle encrypted signals. This amplifier conforms to the copy protection technology of DTLA (Revision 1.2).
- Sound fields and LIP SYNC function (page 37) are not activated when DSD signals are input to this amplifier.

### Establishing a LINC

Before an audio signal can be transmitted between i.LINK components, a LINC (Logical INterface Connection) must first be established between the component receiving the audio signal and the component sending the audio signal. Establishing a LINC means establishing a logical path for the transmission of digital audio signals between the two components. Each logical path has an ID number. Since the component that sends an audio signal must output the signal to a path, and the component that receives the signal must input it from the same path, the path must be mutually known by both components. During the establishment of a LINC, the following communication occurs between the two i.LINK components.

### Example

This amplifier establishes a LINC with SCD-XA9000ES. Select i.LINK using the INPUT SELECTOR on this unit, and set the player to i.LINK output mode.

- ① This amplifier sends a request and path information to SCD-XA9000ES to establish a transmission path for the audio signal.

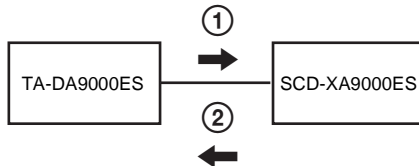

- ② SCD-XA9000ES responds to the component, agreeing to the establishment of a LINC.

The digital audio signal transmission becomes possible only after the communication described above has occurred and a LINC has been established.

### Notes

The LINC is cancelled in the following cases.

- When i.LINK cable is connected or disconnected.
- When the input selection is switched.

## Additional Information

### Precautions

#### On safety

Should any solid object or liquid fall into the cabinet, unplug the amplifier and have it checked by qualified personnel before operating it any further.

#### On power sources

- Before operating the unit, check that the operating voltage is identical with your local power supply. The operating voltage is indicated on the nameplate at the rear of the amplifier.
- The unit is not disconnected from the AC power source (mains) as long as it is connected to the wall outlet, even if the unit itself has been turned off.
- If you are not going to use the amplifier for a long time, be sure to disconnect the amplifier from the wall outlet. To disconnect the AC power cord, grasp the plug itself; never pull the cord.
- (Models of area code U, CA only)  
One blade of the plug is wider than the other for the purpose of safety and will fit into the wall outlet only one way. If you are unable to insert the plug fully into the outlet, contact your dealer.
- AC power cord must be changed only at the qualified service shop.

#### On heat buildup

Although the unit heats up during operation, this is not a malfunction. If you continuously use this unit at a large volume, the cabinet temperature of the top, side and bottom rises considerably. To avoid burning yourself, do not touch the cabinet.

#### On placement

- Place the amplifier in a location with adequate ventilation to prevent heat buildup and prolong the life of the amplifier.
- Do not place the amplifier near heat sources, or in a place subject to direct sunlight, excessive dust or mechanical shock.
- Do not place anything on top of the cabinet that might block the ventilation holes and cause malfunctions.
- Do not place the amplifier near equipment such as a television, video deck or cassette deck. (If the amplifier is being used in combination with a television, video deck or cassette deck and is placed too close to that equipment, noise may result, and picture quality may suffer. This is especially likely when using an indoor antenna. Therefore, we recommend using an outdoor antenna.)

#### On operation

Before connecting other components, be sure to turn off and unplug the amplifier.

#### On cleaning

Clean the cabinet, panel and controls with a soft cloth slightly moistened with a mild detergent solution. Do not use any type of abrasive pad, scouring powder or solvent such as alcohol or benzine.

If you have any question or problem concerning your amplifier, please consult your nearest Sony dealer.

# Troubleshooting

If you experience any of the following difficulties while using the amplifier, use this troubleshooting guide to help you remedy the problem. Should any problem persist, consult your nearest Sony dealer.

---

## There is no sound no matter which component is selected.

- Check that both the amplifier and all components are turned on.
- Check that the MASTER VOLUME control is not set at  $-\infty$  dB.
- Check that the SPEAKERS is not set to “OFF” (page 45).
- Check that all speaker cords are connected correctly.
- Press MUTING on the remote to cancel the muting function.
- Check that “OUTPUT” in the SURR SET UP menu is set to “ALL ON”.

---

## There is no sound from a specific component.

- Check that the component is connected correctly to the audio input jacks for that component.
- Check that the cord(s) used for the connection is (are) fully inserted into the jacks on both the amplifier and the component.

---

## There is no sound from one of the front speakers.

- Connect a pair of headphones to the PHONES jack to verify that sound is output from the headphones. If only one channel is output from the headphones, the component may not be connected to the amplifier correctly. Check that all the cords are fully inserted into the jacks on both the amplifier and the component. If both channels are output from the headphones, the front speaker may not be connected to the amplifier correctly. Check the connection of the front speaker which is not outputting any sound.
- Make sure you have not connected only the L or R jack to a monaural component. Use a monaural-stereo cable (not supplied) and connect it to both the L and R jacks. However, there will be no sound from the center speaker when a sound field (PRO LOGIC, etc.) is selected. When the center speaker is set to “NO”, sound is output only from front L/R speakers.

---

## There is no sound or only a very low-level sound is heard.

- Check that the speakers and components are connected securely.
- Check that you have selected the correct component with INPUT SELECTOR.
- Check that the SPEAKERS is not set to “OFF” (page 45).
- Check that the headphones are not connected.
- Press MUTING on the remote to cancel the muting function.
- When only a very low-level sound is heard, check to see if NIGHT MODE is activated (page 29).
- The protective device on the amplifier has been activated. Turn off the amplifier, eliminate the short-circuit problem and turn on the power again.

---

## There is no sound from analog 2 channel sources.

- Check that the DIGITAL ASSIGN function is not used to assign the digital audio input for the selected input (page 31).
- Check that the INPUT MODE is not set to “COAXIAL FIXED” nor “OPTICAL FIXED” for the selected input (page 32).
- Check that the MULTI CH IN function is not selected.

---

## There is no sound from digital sources (from COAXIAL or OPTICAL input jack).

- Check that the DIGITAL ASSIGN function is not used to assign the digital audio input of the selected input to the other input (page 31).
- Check that the INPUT MODE is not set to “ANALOG 2CH FIXED” (page 32). Check that the INPUT MODE is not set to “COAXIAL FIXED” for the sources from OPTICAL input jack, nor set to “OPTICAL FIXED” for the sources from COAXIAL input jack.
- Check that the MULTI CH IN function is not selected.

---

## There is no sound when i.LINK is selected.

- Check that the i.LINK component is connected correctly.
- Check that SCD-XA9000ES is set to output signals from the i.LINK jack.

---

## The left and right sounds are unbalanced or reversed.

- Check that the speakers and components are connected correctly and securely.
- Adjust balance parameters in the LEVEL menu.

---

**There is severe hum or noise.**

- Check that the speakers and components are connected securely.
- Check that the connecting cords are away from a transformer or motor, and at least 3 meters away from a TV set or fluorescent light.
- Move your TV away from the audio components.
- Check that equipment such as a video deck or cassette deck is not placed on top of the amplifier.
- Make sure you have grounded the SIGNAL GND terminal (only when a turntable is connected).
- The plugs and jacks are dirty. Wipe them with a cloth slightly moistened with alcohol.

---

**There is no sound from the center speaker.**

- Make sure the sound field function is on (press A.F.D., MOVIE or MUSIC).
- Select the CINEMA STUDIO EX mode (page 27).
- Adjust the speaker level (page 33).
- Make sure the center speaker is set to either "SMALL" or "LARGE" (page 18).

---

**There is no sound or only a very low-level sound is heard from the surround/surround back speakers.**

- Make sure the sound field function is on (press A.F.D., MOVIE or MUSIC).
- Select a CINEMA STUDIO EX mode (page 33).
- Adjust the speaker level (page 21).
- Make sure the surround speakers are set to either "SMALL" or "LARGE" (page 19).

---

**There is no sound from the surround back speakers.**

- Some discs have no Dolby Digital EX flag even though the packages have Dolby Digital EX logos. In this case, select "MATRIX" (page 30).

---

**There is no sound from sub woofer.**

- When all speakers are set to "LARGE" and "Neo:6 Cinema" or "Neo:6 Music" is selected, there is no sound from the sub woofer.

---

**The surround effect cannot be obtained.**

- Make sure the sound field function is on (press A.F.D., MOVIE or MUSIC).
- Sound fields do not function for the signals with a sampling frequency of more than 48 kHz.

---

**Dolby Digital or DTS multi channel sound is not reproduced.**

- Check that the playing DVD, etc. is recorded in Dolby Digital or DTS format.
- When connecting the DVD player, etc. to the digital input jacks of this amplifier, check the

audio setting (settings for the audio output) of the connected component.

---

**Recording cannot be done.**

- Check that the components are connected correctly.
- Select the source component with REC OUT SELECTOR +/-.

---

**There is no picture or an unclear picture appears on the TV screen or monitor.**

- Select the appropriate input on the amplifier.
- Set your TV to the appropriate input mode.
- Move your TV away from the audio components.
- Connect your TV to the receiver using the same type of connecting cord as the one used to connect the receiver and video component (pages 7 and 10).

---

**Remote control**

---

**The remote does not function.**

- Point the remote at the remote sensor on the amplifier.
- Remove any obstacles in the path between the remote and the amplifier.
- Replace all the batteries in the remote with new ones, if they are weak.
- Check if the command modes of the amplifier and the remote is the same. If the command mode of the amplifier and the remote is different, you cannot operate the amplifier with the remote. To switch the command mode of the remote, press I/⏻ while pressing INPUT MODE. Each time you press I/⏻, the command mode switches between "C.MODE. AV2" and "C.MODE. AV1". (The initial setting is "C.MODE. AV2".)
- Make sure you select the correct input on the remote.

---

**Error messages**

If there is a malfunction, the display shows a code of two numbers and a message. You can check the condition of the system by the message. Refer to the following table to solve the problem. If any problem persists, consult your nearest Sony dealer.

---

**DECODE ERROR/CHECK CODE 01**

Appears when the signal which the amplifier cannot decode (ex. DTS-CD) is input when "DEC. PRIORITY" in the CUSTOMIZE menu is set to "PCM". Set to "AUTO".

**PROTECTOR/CHECK CODE 11**

Irregular current is output from the speakers. Turn off the amplifier, check the speaker connection and turn on the power again.

**PROTECTOR/CHECK CODE 12**

The amplifier section is overheated. Check that the ventilation hole is not covered. Turn off the amplifier, leave the amplifier for a while and turn on the power again.

**PROTECTOR/CHECK CODE 13**

The power section is overheated. Check that the ventilation hole is not covered. Turn off the amplifier, leave the amplifier for a while and turn on the power again.

**PROTECTOR/CHECK CODE 21**

Turn off the amplifier and consult your nearest Sony dealer.

**PROHIBITED/CHECK CODE 71**

The amplifier cannot output the sound due to the copyright protection.

**UNKNOWN SIGNAL/CHECK CODE 72**

The amplifier is not compatible with the format of the input signal.

**Reference sections for clearing the memory**

To clear	See
All memorized settings	page 17
Customized sound fields	page 33

**Specifications**

**Amplifier section**

**POWER OUTPUT**

Rated Power Output at Stereo Mode<sup>1)</sup>  
 (8 ohms, 20 Hz – 20 kHz, THD 0.15%)  
 200 W + 200 W

(4 ohms, 20 Hz – 20 kHz, THD 0.15%)  
 220 W + 220 W

Reference Power Output

(8 ohms, 1 kHz, THD 0.09%)

FRONT<sup>2)</sup>: 200 W + 200 W

CENTER<sup>2)</sup>: 200 W

SURR<sup>2)</sup>: 200 W + 200 W

SURR BACK<sup>2)</sup>: 200 W + 200 W

(4 ohms, 1 kHz, THD 0.09%)

FRONT<sup>2)</sup>: 220 W + 220 W

CENTER<sup>2)</sup>: 220 W

SURR<sup>2)</sup>: 220 W + 220 W

SURR BACK<sup>2)</sup>: 220 W + 220 W

Actual Rated Maximum Output at Stereo Mode<sup>1)</sup>

(8 ohms, JEITA) 260 W + 260 W

(4 ohms, JEITA) 320 W + 320 W

Actual Rated Maximum Output at Surround Mode

(8 ohms, JEITA) FRONT<sup>2)</sup>: 260 W + 260 W

CENTER<sup>2)</sup>: 260 W

SURR<sup>2)</sup>: 260 W + 260 W

SURR BACK<sup>2)</sup>: 260 W + 260 W

(4 ohms, JEITA) FRONT<sup>2)</sup>: 320 W + 320 W

CENTER<sup>2)</sup>: 320 W

SURR<sup>2)</sup>: 320 W + 320 W

SURR BACK<sup>2)</sup>: 320 W + 320 W

1) Depending on the sound field settings and the source, there may be no sound output.

2) Measured under the following conditions:

Area code	Power requirements
CEL	230 V AC, 50/60 Hz
TW	110 V AC, 60 Hz
KR	230 V AC, 60 Hz

Frequency response

PHONO RIAA equalization curve  
 ±0.5 dB

Power Amp Block 10 Hz – 50 kHz  
 ± 3 dB (8 ohms)

Inputs (Analog)

PHONO Sensitivity: 3.5 mV  
 Impedance: 50 kilohms  
 S/N<sup>3)</sup>: 90 dB (A, 40 mV<sup>4)</sup>)

*continued*

CD/SACD, TAPE, MD/DAT, DVD, LD, TV/SAT, VIDEO 1, 2, 3, 4, 5	Sensitivity: 170 mV Impedance: 50 kilohms S/N <sup>3</sup> : 100 dB (A, 2V <sup>4</sup> )
--	---

- 3) Input shorted and sealed at VOL MAX.  
4) Weighted network + 20 kHz LPF, input level.

#### Inputs (Digital)

CD/SACD, DVD, LD, VIDEO 1, TV/SAT (Coaxial)	Impedance: 75 ohms S/N: 100 dB (A Network, 20 kHz LPF)
---	--

CD/SACD, DVD, LD, TV/SAT, MD/DAT, VIDEO1, 3 (Optical)	S/N: 100 dB (A Network, 20 kHz LPF)
---	--

#### Outputs

TAPE, MD/DAT (REC OUT), VIDEO 1, 2, 3 (AUDIO OUT)	Voltage: 170 mV Impedance: 2.2 kilohms
---	---

FRONT L/R, CENTER, SURROUND L/R, SURROUND BACK L/R, SUB WOOFER	Voltage: 2 V Impedance: 220 ohms
--	-------------------------------------

#### EQUALIZER

Gain levels	±10 dB, 1 dB step
-------------	-------------------

### Video section

#### Inputs/Outputs

Video:	1 V <sub>p-p</sub> , 75 ohms
S-video:	Y: 1 V <sub>p-p</sub> , 75 ohms C: 0.286 V <sub>p-p</sub> , 75 ohms

COMPONENT VIDEO:	Y: 1 V <sub>p-p</sub> , 75 ohms P <sub>B</sub> /C <sub>B</sub> /B-Y: 0.7 V <sub>p-p</sub> , 75 ohms P <sub>R</sub> /C <sub>R</sub> /R-Y: 0.7 V <sub>p-p</sub> , 75 ohms 80 MHz HD Pass Through
------------------	---

### i.LINK section

Pin	4 pins
Transmission speed	S200 (Maximum data transmission speed 200 Mbps)
Transmission protocol Format (input)	A/M transmission protocol Super Audio CD* (DSD PLAIN) 2 channel linear PCM (IEC-60958-3) Sampling frequency: 44.1 kHz

\* Conforms to the copy protection technology of DTLA (Revision 1.2).

### General

#### Power requirements

Area code	Power requirements
CEL	230 V AC, 50/60 Hz
TW	110 V AC, 60 Hz
KR	220 V AC, 60 Hz

Power consumption	600 W
Power consumption (during standby mode)	1 W

#### AC outlets

Area code	AC outlets
CEL	1 switched, 100 W MAX
TW, KR	– (no AC outlet)

Dimensions	430 × 238 × 480 mm including projecting parts and controls
------------	--

Mass (Approx.)	28.5 kg
----------------	---------

### Supplied accessories

- AC power cord (1)
- Easy Setup Guide (1)
- Remote commander RM-LJ312 (1)
- Operating Instructions for RM-LJ312 (1)
- R6 (size-AA) batteries (3)

For details on the area code of the component you are using, see page 2.

Design and specifications are subject to change without notice.



# List of button locations and reference pages

## How to use this page

Use this page to find the location of buttons and other parts of the system that are mentioned in the text.

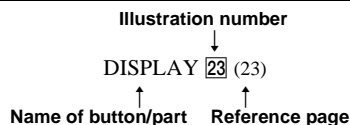

## Main unit

### ALPHABETICAL ORDER

A.F.D. **7** (26, 27, 29)  
BASS **37** (35)  
DECODE PRIORITY **24** (37)  
Digital Cinema Sound indicator  
**5**  
DIMMER **16**  
DIRECT **25** (29)  
DIRECT indicator **2**  
DISPLAY **23** (23)  
Display **3** (23)  
ENTER **21** (31, 44)  
Input indicators **14**  
INPUT MODE **12** (32)  
INPUT SELECTOR **11** (22, 32, 44)  
IR receptor **15**  
MAIN MENU **33** (18, 23, 31, 32, 33, 34, 35, 42, 44)  
MASTER VOLUME **10** (22)  
MENU **31** (18, 23, 31, 32, 33, 34, 35, 42, 44)  
MOVIE **8** (27)  
MULTI CH IN 1/2 **26** (23)  
MULTICHANNEL DECODING indicator **13**  
MUSIC **9** (28, 33)  
NIGHT MODE **18**  
ON SCREEN **19**  
PHONES jack **36**  
REC OUT SELECTOR +/- **28**  
SB DEC indicator **4**  
SLEEP **17**  
SPEAKERS FRONT switch **34** (45)  
SPEAKERS SURROUND switch **32** (45)  
SURR BACK DECODING **27** (29)  
TEST TONE **20**  
TREBLE **35** (35)

USER PRESET **22** (42)  
VIDEO 5 INPUT jacks **29** (12)

### NUMBERS AND SYMBOLS

2CH **6** (26)  
I/⏻ (power) **1**  
-/+ **30** (18, 31, 32, 33, 34, 35, 42, 44)



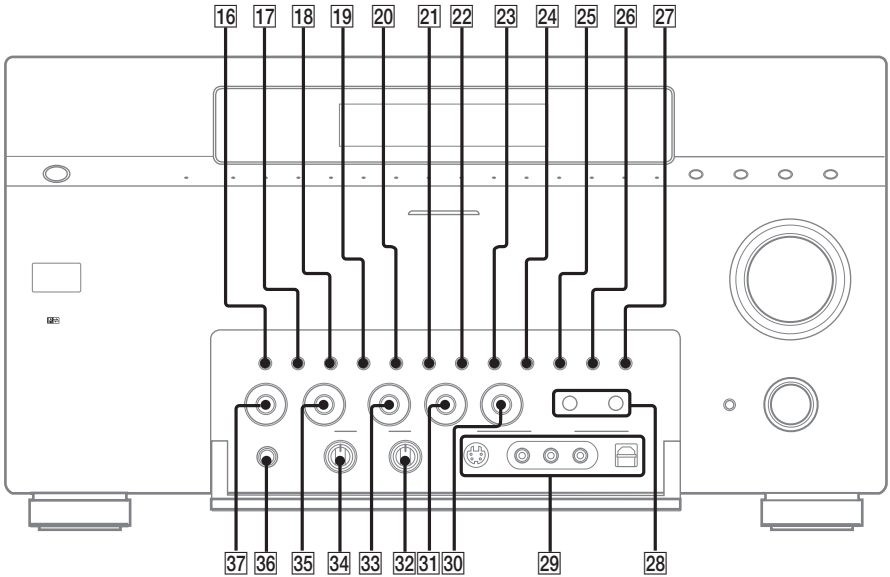
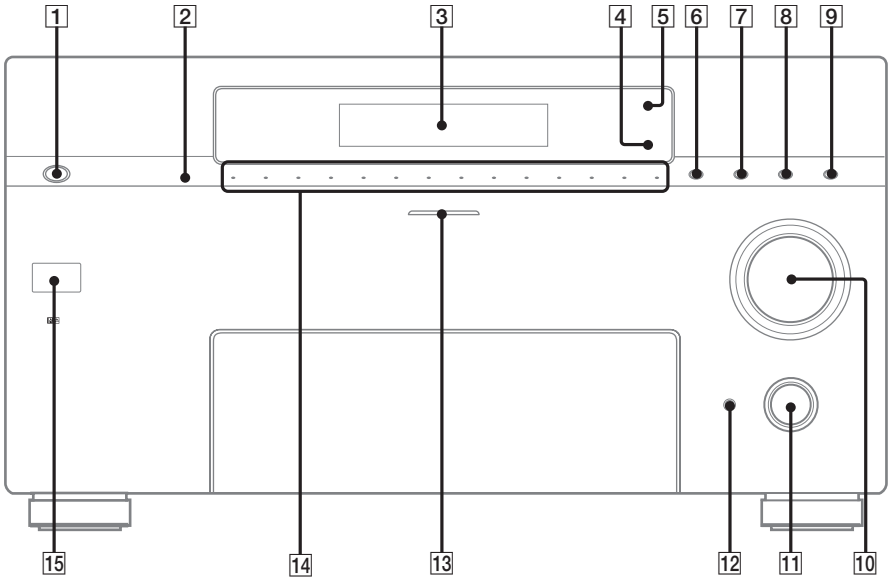

# Index

## A

### Adjusting

- CUSTOMIZE parameters 36
- EQUALIZER parameter 34
- LEVEL parameter 33, 40, 41
- SPEAKER SET UP parameters 18, 38
- speaker volume 21
- SURR SET UP parameters 32

## C

### Changing

- display 23
- effect level 32

### Clearing receiver's memory 17

### CONTROL A1 II 48

### Crossover frequency 39

### CUSTOMIZE menu 36

## D

### Digital Cinema Sound 27

### Dubbing. *See* Recording

## E

### Editing. *See* Recording

### Effect level 32

### EQUALIZER menu 34

## I

### Indexing. *See* Naming

## L

### Labeling. *See* Naming

### LEVEL menu 40, 41

## N

### Naming 44

## R

### Recording

on a video tape 47

on an audio tape or MD 46

## S

### Selecting

- component 22
- front speaker system 45
- sound field 27–28

### Sleep Timer 44

### Sound field

- customizing 32
- pre-programmed 27–28
- resetting 33
- selecting 27–28

### SPEAKER SET UP menu 18, 38

### Speakers

- adjusting speaker volume 21
- connection 13
- impedance 13, 14
- placement 13

### Supplied accessories 54

### SURR SET UP menu 32, 40

## T

### Test tone 21





Printed on 100% recycled paper.