

Compact Hi-Fi Stereo System

Operating Instructions

Owner's Record

The model and serial numbers are located on the rear of the unit. Record the serial number in the space provided below. Refer to them whenever you call upon your Sony dealer regarding this product.

Model No. _____ Serial No. _____



FST-ZX8

FST-ZX6

LBT-ZX8

LBT-ZX6

WARNING

To reduce the risk of fire or electric shock, do not expose this apparatus to rain or moisture.

To prevent fire, do not cover the ventilation of the apparatus with newspapers, table-cloths, curtains, etc. And don't place lighted candles on the apparatus.

To prevent fire or shock hazard, do not place objects filled with liquids, such as vases, on the apparatus.

Do not install the appliance in a confined space, such as a bookcase or built-in cabinet.

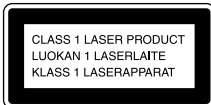

This appliance is classified as a CLASS 1 LASER product. This label is located on the rear exterior.



Don't throw away the battery with general house waste, dispose of it correctly as chemical waste.

NOTICE FOR THE CUSTOMERS IN THE U.S.A.

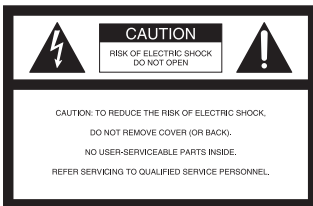

This symbol is intended to alert the user to the presence of uninsulated "dangerous voltage" within the product's enclosure that may be of sufficient magnitude to constitute a risk of electric shock to persons.



This symbol is intended to alert the user to the presence of important operating and maintenance (servicing) instructions in the literature accompanying the appliance.



WARNING

This equipment has been tested and found to comply with the limits for a Class B digital device, pursuant to Part 15 of the FCC Rules. These limits are designed to provide reasonable protection against harmful interference in a residential installation. This equipment generates, uses, and can radiate radio frequency energy and, if not installed and used in accordance with the instructions, may cause harmful interference to radio communications. However, there is no guarantee that interference will not occur in a particular installation. If this equipment does cause harmful interference to radio or television reception, which can be determined by turning the equipment off and on, the user is encouraged to try to correct the interference by one or more of the following measures:

- Reorient or relocate the receiving antenna.
- Increase the separation between the equipment and receiver.
- Connect the equipment into an outlet on a circuit different from that to which the receiver is connected.
- Consult the dealer or an experienced radio/TV technician for help.

CAUTION

You are cautioned that any changes or modification not expressly approved in this manual could void your authority to operate this equipment.

Note to CATV system installer:

This reminder is provided to call CATV system installer's attention to Article 820-40 of the NEC that provides guidelines for proper grounding and, in particular, specifies that the cable ground shall be connected to the grounding system of the building, as close to the point of cable entry as practical.

For customers in the United States



ENERGY STAR[®] is a U.S. registered mark. As an ENERGY STAR[®] partner, Sony Corporation has determined that this product meets the ENERGY STAR[®] guidelines for energy efficiency.

Table of Contents

| | |
|-------------------------|---|
| About this manual | 5 |
| Playable discs | 5 |

Getting Started

| | |
|--------------------------------|----|
| Hooking up the system | 8 |
| Positioning the speakers | 10 |
| Setting the clock | 11 |

CD/MP3

| | |
|---------------------------------|----|
| Loading a disc | 12 |
| Playing a disc | 12 |
| — Normal Play/Shuffle Play | |
| Playing repeatedly | 14 |
| — Repeat Play | |
| Creating your own program | 15 |
| — Program Play | |

Tuner

| | |
|---------------------------------|----|
| Presetting radio stations | 16 |
| Listening to the radio | 17 |
| — Preset Tuning | |
| — Manual Tuning | |

Tape

| | |
|----------------------|----|
| Loading a tape | 18 |
| Playing a tape | 18 |

Tape - Recording

| | |
|---|----|
| Recording your favorite tracks on a disc into a tape | 19 |
| — CD Synchro Recording | |
| — Program Edit | |
| Recording to a tape manually | 20 |
| — Manual Recording | |

Sound Adjustment

| | |
|--|----|
| Adjusting the sound | 21 |
| Selecting the preset effect | 22 |
| Adjusting the graphic equalizer and storing the personal file | 22 |
| Selecting the surround effect | 23 |
| Selecting the MP3 Booster effect | 23 |
| Creating a party environment | 24 |
| (FST-ZX8/LBT-ZX8 only) | |
| — X-ROUND | |
| — FLASH | |
| Listening to the sound in another room | 25 |
| — Multi Room | |
| (FST-ZX8/LBT-ZX8 only) | |
| Enhancing the video game sound | 25 |
| — Game Sync | |
| Mixing video game sound with other sound source | 26 |
| — Game Mixing | |
| Singing along | 26 |

Timer

| | |
|--------------------------------------|----|
| Falling asleep to music | 27 |
| — Sleep Timer | |
| Waking up to music | 27 |
| — Play Timer | |
| Timer recording radio programs | 28 |

Display

| | |
|--|----|
| Turning off the display | 29 |
| — Power Saving Mode | |
| Viewing information about the disc in the display | 30 |
| Changing the power illuminator | 31 |
| Changing the spectrum analyzer display | 31 |
| Adjusting the brightness of the display | 32 |

Optional Components

| | |
|--|----|
| Hooking up optional components | 33 |
| Listening to audio from a connected component | 34 |
| Recording on a connected component | 35 |
| Connecting external antennas | 35 |

Troubleshooting

| | |
|-----------------------------|----|
| Problems and remedies | 36 |
| Messages | 39 |

Additional Information

| | |
|---|----|
| Precautions | 40 |
| Specifications | 41 |
| List of button locations and reference pages | 44 |

About this manual

- The instructions in this manual are for models FST-ZX8, FST-ZX6, LBT-ZX8 and LBT-ZX6. In this manual, the FST-ZX8 is used for illustration purposes unless stated otherwise.
- This manual mainly explains operations using the buttons on the system, but the same operations can also be performed using the buttons on the remote having the same or similar names.

The FST-ZX8/LBT-ZX8 consists of the following components:

- Tuner/CD/MP3 player/Stereo cassette deck/Amplifier (main unit) HCD-ZX8
- Speaker System
 - Front/Surround speakers SS-ZX8



The FST-ZX6/LBT-ZX6 consists of the following components:

- Tuner/CD/MP3 player/Stereo cassette deck/Amplifier (main unit) HCD-ZX6
- Speaker System
 - Front speakers SS-ZX6

Playable discs

You can playback the following discs on this system. The other discs cannot be played back.

List of playable discs

| Format of discs | Disc logo | Contents |
|--|---|----------|
| Audio CDs |  | Audio |
| CD-R/CD-RW (Audio CDs) |  | Audio |
| CD-R/CD-RW (Discs with MP3 audio tracks) |  | Audio |

Discs that this system cannot play

- A disc that has a non-standard shape (e.g., card, heart).
- A disc that has the adhesive, cellophane tape, or a sticker still left on it.
- Discs other than the following:
 - Audio CDs
 - CD-Rs/CD-RWs that recorded in the Audio CD format.
 - CD-Rs/CD-RWs and CD-ROMs that has MP3 audio tracks those format that conforms to ISO 9660^{*1} Level 1, Level 2, Joliet in expansion format or Multi Session^{*2}. MP3 audio tracks must be in MPEG 1, 2, 2.5 Audio Layer 3 format.
- Data part of CD-Extras^{*3}.
- Data part of Mixed CDs^{*4}.
- Audio side of a DualDisc.

^{*1} ISO 9660 Format

The most common international standard for the logical format of files and folders on a CD-ROM. There are several specification levels. In Level 1, file names must be in the 8.3 format (no more than eight characters in the name, no more than three characters in the extension “.MP3”) and in capital letters. Folder names can be no longer than eight characters. There can be no more than eight nested folder levels. Level 2 specifications allow file names and folder names up to 31 characters long. Each folder can have up to 8 trees. For Joliet or Romeo in the expansion format, make sure of the contents of the writing software, etc.

^{*2} Multi Session

This is a recording method that enables adding of data using the Track-At-Once method. Conventional discs begin at a disc control area called the Lead-in and end at an area called Lead-out. A Multi Sessions disc is a disc having multiple sessions, with each segment from Lead-in to Lead-out regarded as a single session.

^{*3} CD-Extra

This format records audio (audio CD data) on the tracks in session 1 and data on the tracks in session 2.

^{*4} Mixed CD

This format records data on the first track and audio (audio CD data) on the second and subsequent tracks of a session.

Notes on discs

- This system can play CD-R/CD-RW discs edited by the user. However, note that playback of some discs may not be possible depending on the recording device used for recording or the disc condition.
- Discs recorded on CD-R/CD-RW drives may not be played back because of scratches, dirt, recording condition or the driver’s characteristics.
- CD-R and CD-RW discs that have not been finalized (processing to allow playback by a normal disc player) cannot be played back.
- CD-R and CD-RW discs recorded in Multi Session that have not ended by “closing the session” are not supported.
- The system may be unable to playback MP3 format files that do not have the extension “.MP3”.
- Attempting to playback non-MP3 format files that have the extension “.MP3” may result in noise or malfunction.
- With format other than ISO 9660 Level 1, Level 2 or Joliet in expansion format, album titles or track titles may not be displayed correctly.
- The following discs take a longer time to start playback.
 - a disc recorded with complicated tree structure.
 - a disc recorded in Multi Session.
 - a disc to which data can be added (non-finalized disc).

CD-RWs that recorded in packet write format cannot be played back.

Note on DualDiscs

This product is designed to play back discs that conform to the Compact Disc (CD) standard. A DualDisc is a two sided disc product which mates DVD recorded material on one side with digital audio material on the other side. Please be aware that the audio side of a DualDisc may not be played back on this product because these discs do not conform to the CD standard. “DualDisc” is a trademark of the Recording Industry Association of America (RIAA).

Music discs encoded with copyright protection technologies

This product is designed to playback discs that conform to the Compact Disc (CD) standard. Recently, various music discs encoded with copyright protection technologies are marketed by some record companies. Please be aware that among those discs, there are some that do not conform to the CD standard and may not be playable by this product.

Cautions when playing a disc that is recorded in Multi Session

- This system can play Multi Session discs when an MP3 audio track is contained in the first session. Any subsequent MP3 audio tracks recorded in later sessions can also be played back.
- When you play Multi Session discs with different formats for each session, the format of the first session is recognized as the disc type. Tracks in the second and subsequent sessions are played if they are the same formats as the first session.

Getting Started

Hooking up the system

Do the following procedures **1** to **5** to hook up your system using the supplied cords and accessories (page 43).

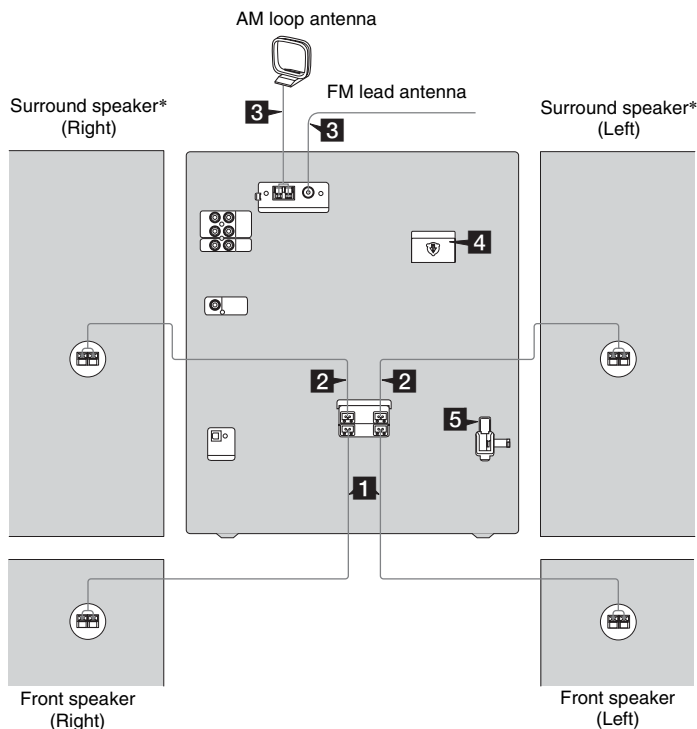

* FST-ZX8/LBT-ZX8 only.

1 Connect the front speakers.

(FST-ZX8/LBT-ZX8 only)

Connect the speaker cords to the FRONT SPEAKER (SPEAKER A) terminals.

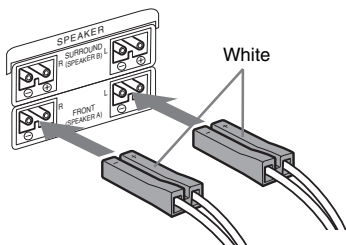

(FST-ZX6/LBT-ZX6 only)

Connect the speaker cords to the SPEAKER terminals.

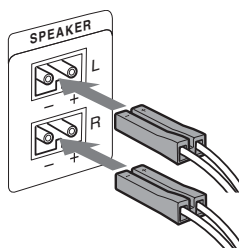

Tip

Connect the speaker cords to the terminals on the speakers.

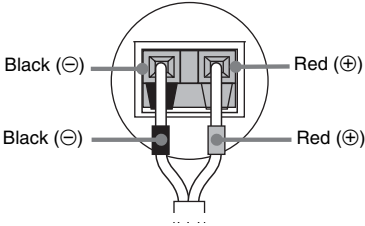

2 **Connect the surround speakers.**
(FST-ZX8/LBT-ZX8 only)

Connect the speaker cords to the SURROUND SPEAKER (SPEAKER B) terminals and to the terminals on the speakers as shown in the tip above.

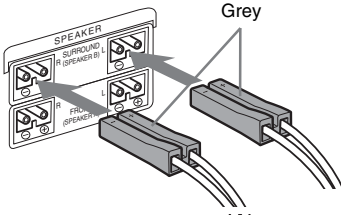

3 **Connect the FM and AM antennas.**

Set up the AM loop antenna, then connect it.

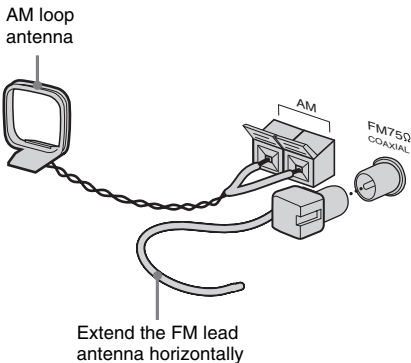
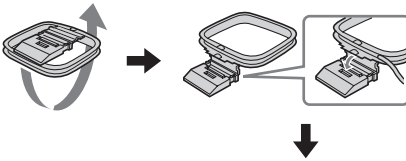

4 **For models equipped with a voltage selector, set VOLTAGE SELECTOR to the position of your local power line voltage.**

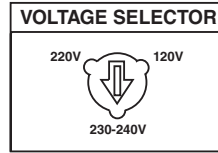

5 **Connect the power cord to a wall outlet.**

The demonstration appears in the display. When you press I/⏻, the system turns on and the demonstration automatically ends.

Notes

- Keep the speaker cords away from the antennas to prevent noise.
- Be sure to match the color of the speaker terminals on the system and the connectors.
- Be sure to connect the speakers securely and correctly.

Inserting two R6 (size AA) batteries into the remote

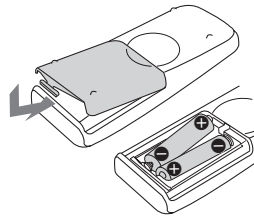
**Note**

If you do not use the remote for a long period of time, remove the batteries to avoid possible damage from battery leakage and corrosion.

Tip

With normal use, the batteries should last for about six months. When the remote no longer operates the system, replace both batteries with new ones.

Attaching the speaker pads

Attach the supplied speaker pads to the bottom of the speakers to stabilize the speakers and prevent them from slipping.

FST-ZX8/LBT-ZX8 only

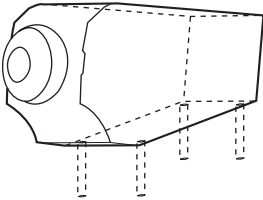

FST-ZX6/LBT-ZX6 only

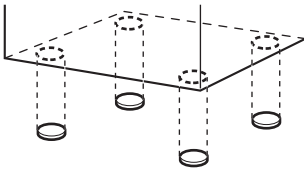

Notice for carrying this system

Do the following procedure to protect the disc mechanism. Use buttons on the system for the operation.

- 1 Press I/⏻ to turn on the system.
- 2 Make sure that all discs are removed from the system.
- 3 Hold down REPEAT and then press I/⏻ until "LOCK" appears in the display.
- 4 Release I/⏻ first, then release REPEAT.
- 5 Unplug the power cord.

Positioning the speakers

Positioning the speakers for FST-ZX8/LBT-ZX8 only

There are 3 ways to place the front speakers and the surround speakers.

Example 1: Place the surround speakers on the top of the front speakers as shown below.

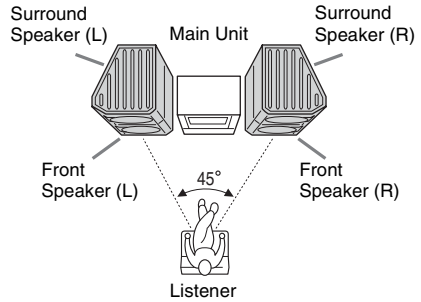

Example 2: Place the speakers at an equal distance from your listening position as shown below.

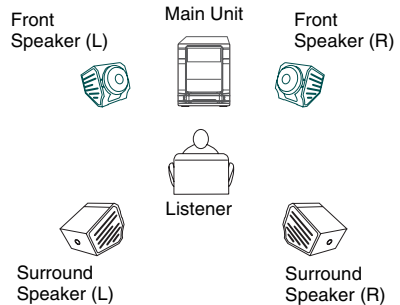

Example 3: Place the front speakers in one room and the surround speakers in another room.

Positioning the speakers for FST-ZX6/LBT-ZX6 only

Place the front speakers at an angle of 45 degrees from your listening position.

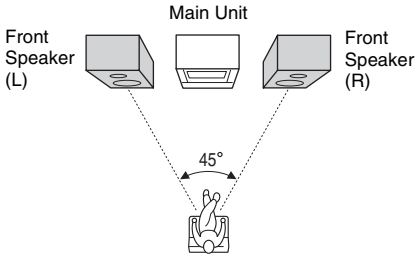

Setting the clock

- 1** Press **I/⏻** to turn on the system.
- 2** Press **CLOCK/TIMER SET**.
“CLOCK” appears in the display. Then, the hour indication flashes in the display.
- 3** Press **↑** or **↓** (or **▶▶I+** or **-I◀◀** on the remote) repeatedly to set the hour.
- 4** Press **ENTER**.
The minute indication flashes in the display.
- 5** Press **↑** or **↓** (or **▶▶I+** or **-I◀◀** on the remote) repeatedly to set the minute.
- 6** Press **ENTER**.
The clock starts functioning.

To adjust the clock

- 1** Press **CLOCK/TIMER SET**.
“PLAY SET?” flashes in the display.
- 2** Press **↑** or **↓** (or **▶▶I+** or **-I◀◀** on the remote) to select “CLOCK SET?”, then press **ENTER**.
The hour indication flashes in the display.
- 3** Do the same procedures as step 3 to 6 above.

Note

The clock settings are canceled when you disconnect the power cord or if a power failure occurs.

Loading a disc

- 1 Press ▲ OPEN/CLOSE.**
The disc tray slides out.
- 2 Place a disc with the label side facing up on the disc tray.**

When you play a CD single, place it on the inner circle of the tray

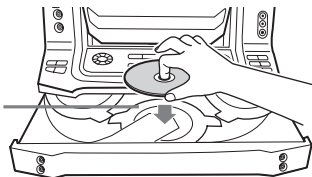

To load additional discs, press DISC SKIP to rotate the disc tray.

- 3 Press ▲ OPEN/CLOSE to close the disc tray.**

Note

Do not push the disc tray when closing it as this may cause malfunction. Press ▲ OPEN/CLOSE to close the disc tray.

Playing a disc

— Normal Play/Shuffle Play

This system lets you play audio CDs and discs with MP3 audio tracks in different play modes.

When playing an audio CD:

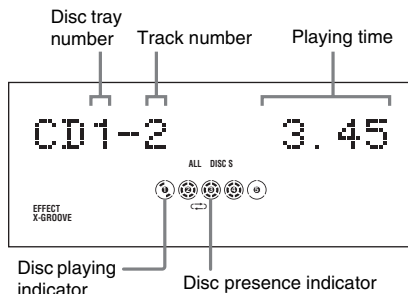

When playing an MP3 audio track:

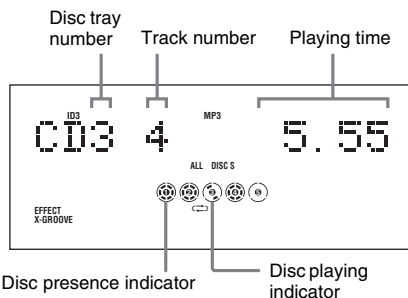

- 1 Press FUNCTION repeatedly until "CD" appears in the display (or press CD on the remote).**

2 When the playback is stopped, press **PLAY MODE** repeatedly until the indication of the play mode you want appears in the display.

| Select | To play |
|----------------------------------|--|
| ALL DISCS (Normal Play) | The tracks on all discs in the disc tray continuously. |
| 1 DISC (Normal Play) | The tracks on the disc you have selected in original order. |
| ALBM (Normal Play) | All MP3 audio tracks in the album on the disc you have selected in original order. When playing an audio CD, "ALBM" play mode performs the same operation as "1 DISC" play mode. |
| ALL DISCS SHUF (Shuffle Play) | The tracks on all discs in random order. |
| 1 DISC SHUF (Shuffle Play) | The tracks on the disc you have selected in random order. |
| ALBM SHUF (Shuffle Play) | The MP3 audio tracks in the album on the disc you have selected in random order. When playing an audio CD, "ALBM SHUF" play mode performs the same operation as "1 DISC SHUF" play mode. |
| PGM (Program Play) | The tracks on all discs in the order you want them to be played back (see "Creating your own program" on page 15). |

3 Press **▶||** (or **▶** on the remote).

▶|| indicator lights up.

Tips

- You cannot change the play mode during playback. To change the play mode, press **■** to stop playback.
- When an MP3 audio track with ID3 tag is played back, "ID3" lights up in the display.
- When the current disc is a disc with MP3 audio tracks, "MP3" lights up in the display.

Other operations

| To | Do this |
|---|---|
| Stop playback | Press ■ . |
| Pause playback | Press ▶ (or on the remote). Press again to resume playback. |
| Select a track | Press ◀◀ or ▶▶ (or -◀◀ or ▶▶+ on the remote) repeatedly. |
| Select an album of MP3 audio tracks | Press ALBUM +/- . |
| Find a point in a track* ¹ | Press and hold down ◀◀ or ▶▶ during playback and release it at the point you want to resume playback. Use button on the remote for this operation while playing an MP3 audio track. |
| Select a disc | Press one of the DISC 1 ~ 5 buttons or DISC SKIP . |
| Switch to CD function from another source and start playback automatically.* ² | Press one of the DISC 1 ~ 5 buttons or ▶ (Automatic Source Selection). |
| Exchange other discs while playing | Press EX-CHANGE . The disc tray slides out. Then press DISC SKIP to select the disc you want to exchange. |
| Remove the disc | Press ▲ OPEN/CLOSE . |

*¹ The playing time may not be displayed correctly depending on the MP3 audio tracks.

*² Only when there is a disc in disc tray.

Notes

- This system can playback MP3 audio tracks in the format of MPEG 1 Audio Layer 3, MPEG 2 Audio Layer 3 and MPEG 2.5 Audio Layer 3.
- This system can playback Multi Session discs when an MP3 audio track is located in the first session. Any subsequent MP3 audio tracks, recorded in the later sessions, can also be played back.
- When naming the MP3 audio tracks, be sure to add the file extension “.MP3” to the file name.
- If you save up the extension “.MP3” to a track other than MP3 audio tracks, the system cannot recognize the track properly and will generate random noise that could damage your speakers.
- You are recommended not to save other type of tracks or unnecessary album on a disc that has MP3 audio tracks.
- The disc recorded with complicated tree structure takes a longer time to start playback.
- When the disc is loaded, the system reads all the tracks in that disc. If there are many albums or non MP3 audio tracks on the disc, it may take a longer time for playback to begin or for the next MP3 audio track to start playback.
- An album that does not include an MP3 audio track is skipped.
- The maximum number of albums on a disc which can be recognize by this system is 150 (including root album).
- The maximum number of MP3 audio tracks and albums on a disc which can be recognize by this system is 300.
- Depending on the encoding/writing software, recording device, or the recording media used at the time an MP3 audio track is recorded, you may encounter problems such as cannot playback, sound interruptions, and noise.

Tips

- When switching to “CD” function from “TUNER” function by pressing **▶||**, a longer time may be required to access the disc. In this case, set “CD POWER ON” by CD power manage function (page 17).
- If you press **▶||** while the system is turned off, the system turns on automatically and “CD” is selected as a function. Then, playback starts if there is a disc in the disc tray (One Touch Play).
- If you press CD on the remote while the system is turned off, the system turns on automatically and “CD” is selected as a function.

Playing repeatedly

— Repeat Play

You can playback all the tracks or a single track on a disc repeatedly.

Press REPEAT repeatedly until “REP” or “REP1” lights up in the display.

REP: All the tracks on the disc, or all the tracks in the album* are played back repeatedly up to five times.

REP1: A single track is played back repeatedly until “REP1” is canceled.

* When “ALBM” or “ALBM SHUF” is selected for MP3 audio tracks.

To cancel Repeat Play

Press REPEAT repeatedly until both “REP” and “REP1” disappear from the display.

Note

You cannot select “REP” and “ALL DISCS SHUF” at the same time.

Creating your own program

— Program Play

You can make a program of up to 25 steps from all the discs in the order you want to play them. You can synchro record the programmed tracks onto a tape (page 19).

- 1 Press FUNCTION repeatedly until “CD” appears in the display (or press CD on the remote).**
- 2 Press PLAY MODE in stop mode repeatedly until “PGM” lights up in the display.**
- 3 Press one of DISC 1 ~ 5 buttons or DISC SKIP to select a disc.**
To program all the tracks on a disc at once, proceed to step 5 while “AL” appears in the display.
To program all the MP3 audio tracks on an album at once, press ALBUM +/- repeatedly until the album you want appears in the display, then proceed to step 5.
- 4 Press ◀◀ or ▶▶ (or -◀◀ or ▶▶+ on the remote) repeatedly until the track number you want appears in the display.**

The total playing time flashes in the display.

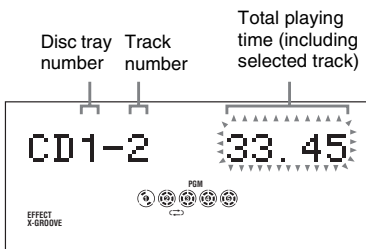

When programming an MP3 audio track, press ALBUM +/- to select album, then press ◀◀ or ▶▶ (or -◀◀ or ▶▶+ on the remote) repeatedly until the track number you want appears in the display.

5 Press PLAY MODE.

The track(s) is (are) programmed.
The program step number appears, followed by total playing time.

6 Program additional discs or tracks.

| To program | Repeat steps |
|-------------------------------|--------------|
| Other discs | 3 and 5 |
| Other tracks on the same disc | 4 and 5 |
| Other tracks on other discs | 3 to 5 |

7 Press ▶◻◻ (or ▶ on the remote).

Program Play starts.

Other operations

| To | Do this |
|----------------------------|---|
| Cancel Program Play | Press PLAY MODE repeatedly until “PGM” disappears from the display. |
| Clear a track from the end | Press CLEAR on the remote when the playback is stopped. |

Tips

- The program you made remains in the system’s memory even after it has been played back. Press ▶◻◻ (or ▶ on the remote) to play the same program again.
- If “--.--” appears instead of the total playing time during programming, this means:
 - you have programmed a track number which exceeds 20.
 - the total playing time has exceeded 100 minutes.
 - you have programmed an MP3 audio track.

Presetting radio stations

You can preset up to 20 FM stations and 10 AM stations. You can then tune in any of those stations simply by selecting the corresponding preset number.

Automatic tuning preset

You can automatically tune in all of the stations that can be received in your area and then store the frequency of your favorite stations manually.

- 1** Press **TUNER/BAND** repeatedly to select “FM” or “AM”.
- 2** Press **TUNING MODE** repeatedly until “AUTO” lights up in the display.
- 3** Press **TUNING +/-** (or **▶▶+ or -◀◀** on the remote) repeatedly to tune in the station you want.

The frequency changes as the system scans for a station. Scanning stops automatically when a station is tuned in. “TUNED” lights up in the display. When a FM stereo program is tuned in, “ST” lights up in the display.

If “TUNED” does not light up in the display and the scanning does not stop

Set the frequency of the radio station you want as described in steps 2 to 6 of “Manual tuning preset”.

- 4** Press **MEMORY** (or **TUNER MEMORY** on the remote).

A preset number flashes in the display. The stations are stored from preset number 1.

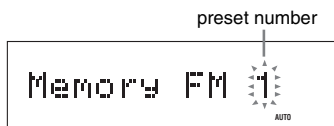

- 5** Press **TUNING +/-** (or **▶▶+ or -◀◀** on the remote) repeatedly to select the preset number you want to store.

- 6** Press **TUNER ENTER** or **ENTER**.
“Complete!” appears in the display. The station is stored.

- 7** Repeat steps 1 to 6 to store other stations.

Manual tuning preset

You can manually tune in and store the radio frequency of your favorite stations.

- 1** Press **TUNER/BAND** repeatedly to select “FM” or “AM”.
- 2** Press **TUNING MODE** repeatedly until “MANUAL” lights up in the display.
- 3** Press **TUNING +/-** (or **▶▶+ or -◀◀** on the remote) repeatedly to tune in the station you want.
- 4** Press **MEMORY** (or **TUNER MEMORY** on the remote).

A preset number flashes in the display. The stations are stored from preset number 1.

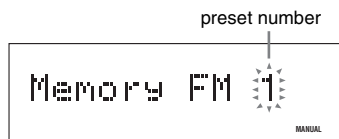

- 5** Press **TUNING +/-** (or **▶▶+ or -◀◀** on the remote) repeatedly to select the preset number you want to store.
- 6** Press **TUNER ENTER** or **ENTER**.
“Complete!” appears in the display. The station is stored.
- 7** Repeat steps 1 to 6 to store other stations.

Other Operations

| To | Do this |
|---------------------------------------|---|
| Tune in a station with a weak signal | Follow the procedure described in “Manual tuning preset” (page 16). |
| Stop scanning during automatic tuning | Press TUNING MODE . |

To improve tuner reception

When the tuner reception is poor, set the CD power manage function to “CD POWER OFF”. The default setting is “CD POWER ON”. Use buttons on the system for the operation.

- 1 Press FUNCTION repeatedly until “CD” appears in the display.
- 2 Press I/⏻ to turn off the system.
- 3 Press I/⏻ while holding down ■ (CD). The system turns on automatically.
“CD POWER OFF” appears in the display.

To set CD power on

Repeat the procedure above and “CD POWER ON” appears in the display.

Notes

- When “CD POWER OFF” is selected, disc access time is increased.
- You cannot change the CD power manage setting in Power Saving Mode (page 29).

To change the AM tuning interval

The factory settings for AM tuning interval is 9 kHz (or 10 kHz for some areas). To change the AM tuning interval, select any AM station first, then turn off the system. While holding down TUNER ENTER, press I/⏻ to turn on the system again. “AM 10k STEP” or “AM 9k STEP” appears in the display. When you change the interval, AM preset stations will be erased. To reset the interval, repeat the same procedure. Use buttons on the system for the operation.

Note

You cannot change the AM tuning interval in the Power Saving Mode (page 29).

Tips

- The preset stations are retained for half a day even if you unplug the power cord or if a power failure occurs.
- If you press TUNER/BAND while the system is turned off, the system turns on automatically and “TUNER” is selected as the function.
- You can also press FUNCTION repeatedly to select “TUNER”.

Listening to the radio

You can listen to a radio station either by selecting a preset station, or by manually tuning in the station.

Listening to a preset station

— Preset Tuning

Before tuning to preset stations, be sure to preset them first (see “Presetting radio stations” on page 16).

- 1 Press TUNER/BAND repeatedly to select “FM” or “AM”.
- 2 Press TUNING MODE repeatedly until “PRESET” lights up in the display.
- 3 Press TUNING +/- (or ►►I+ or I-◄◄ on the remote) repeatedly to select the preset station you want.

Listening to non-preset radio station

— Manual Tuning

- 1 Press TUNER/BAND repeatedly to select “FM” or “AM”.
- 2 Press TUNING MODE repeatedly until “MANUAL” lights up in the display.
- 3 Press TUNING +/- (or ►►I+ or I-◄◄ on the remote) repeatedly to tune in the station you want.

Tips

- To improve broadcast reception, adjust the supplied antennas, or connect an external antenna.
- When an FM stereo program has static noise, press FM MODE repeatedly until “MONO” lights up in the display. There will be no stereo effect, but the reception will improve.
- To record from the radio programs, see “Manual Recording” (page 20).

Tape

Loading a tape

- 1 Press A \blacktriangle or \blacktriangle B.
- 2 Load a tape in deck A or B.

With the side you want to play/record facing forward.

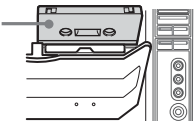

Playing a tape

You can use TYPE I (normal) tape.

- 1 Load a tape.
- 2 Press FUNCTION (or TAPE on the remote) repeatedly until "TAPE A" or "TAPE B" appears in the display.
- 3 Press DIRECTION repeatedly to select " \rightleftarrows " to play one side, " \rightleftarrows " to play both sides or "RELAY" (Relay Play)* to play both decks in succession.
- 4 Press \blacktriangleright (or \blacktriangleright on the remote).

The tape starts playing.

Press \blacktriangleleft (or \blacktriangleright on the remote again) to play the reverse side.

* Relay Play follow this cyclic sequence:

Deck A (front side) \rightarrow Deck A (reverse side) \rightarrow
Deck B (front side) \rightarrow Deck B (reverse side)

Other operations

| To | Do this |
|--|--|
| Stop playback | Press \blacksquare . |
| Pause playback | Press \mathbb{I} on the remote. Press again to resume playback. |
| Fast-forward or rewind | Press $\blacktriangleleft\blacktriangleleft\blacktriangleleft$ or $\blacktriangleright\blacktriangleright\blacktriangleright$ (or press \blacktriangleleft or \blacktriangleright on the remote) in stop mode. |
| Switch to TAPE A or TAPE B function from another source and start playback automatically.* | Press \blacktriangleleft or \blacktriangleright (Automatic source selection). |
| Remove the tape | Press A \blacktriangle or \blacktriangle B in stop mode. |

* Only when there is a tape in tape deck.

Searching for the beginning of a track (AMS*)

During playback, press **◀◀◀◀** or **▶▶▶▶** (or press **◀◀** or **▶▶**+ on the remote) repeatedly for the number of songs you want to skip forward (or backward).

The search direction, + (forward) or – (backward), and the number of songs being skipped (1 to 9) appear in the display.

Example: searching forward 2 songs

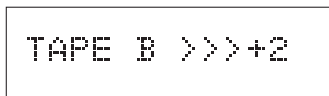

* AMS (Automatic Music Sensor)

Notes

- Do not press **A** ▲ or ▲ **B** while playing a tape, otherwise the tape could be damaged.
- The AMS function may not operate correctly under the following circumstances:
 - When the unrecorded space between songs is less than 4 seconds long.
 - When the system is placed near a television.

Tips

- During “◀↔▶” or Relay Play, the deck stops automatically after repeating the sequence for five times.
- If you press ◀ or ▶ while the system is turned off, the system turns on automatically and “TAPE A” or “TAPE B” is selected as a function. Then, the playback starts if there is tape in the tape deck (One Touch Play).
- If you press ▶ on the remote during “TAPE A” function and there is no tape in deck A, the system automatically switches to “TAPE B” function when there is a tape in deck B. Then, playback will start and vice versa.
- If you press TAPE on the remote while the system is turned off, the system turns on automatically and “TAPE A” or “TAPE B” is selected as a function.

Tape – Recording

Recording your favorite tracks on a disc into a tape

— CD Synchro Recording

You can record a whole disc into a tape. You can use TYPE I (normal) tape. The recording level is adjusted automatically.

- 1 Load a recordable tape into deck B.**
- 2 Press FUNCTION repeatedly until “CD” appears in the display (or press CD on the remote). Load a disc you want to record.**

When you want to record an album of MP3 audio tracks, press **PLAY MODE** repeatedly until “ALBM” lights up in the display and then press **ALBUM +/-** to select the album you want.

- 3 Press CD SYNC.**
Deck B stands by for recording. **REC PAUSE/START** indicator flashes. If you want to record on the reverse side, press ◀ (TAPE B).
- 4 Press DIRECTION repeatedly to select “↔” to record on one side. Select “↔↔” (or “RELAY”) to record on both sides.**
- 5 Press REC PAUSE/START.**
Recording starts.

To stop recording

Press ■ (TAPE B).

Recording a disc by specifying track order

— Program Edit

You can record tracks from all the discs in the order you want. Between step 2 and step 3 of “CD Synchro Recording” (page 19), perform step 1 to 6 of “Creating your own program” (page 15). When programming, make sure the playing times for each side do not exceed the length of one side of the tape.

Notes

- You cannot use Tape Select Edit for discs containing over 20 tracks or MP3 audio tracks.
- You cannot listen to other sources while recording.
- Game Mixing does not function during CD Synchro Recording.

Tip

To check the required tape length for recording a disc, press EDIT after you have loaded a disc in CD function. The required tape length for the currently selected disc appears, followed by the total playing time for side A and side B respectively (Tape Select Edit).

Recording to a tape manually

— Manual Recording

You can record just the portions you like from a disc, tape or radio program on a tape. You can also record from connected components.

- 1 Load a recordable tape into deck B.**
- 2 Press FUNCTION or TUNER/BAND repeatedly (or press CD or press TAPE repeatedly on the remote) to select the recording source you want to record.**
- 3 Load the disc or tape or tune to the station you want to record. To record from connected component, connect the external audio sources.**
- 4 Press REC PAUSE/START.**
Deck B stands by for recording.
REC PAUSE/START indicator flashes.
If you want to record on the reverse side, press ◀ (TAPE B).
- 5 Press DIRECTION repeatedly to select “→” to record on one side. Select “↔” (or “RELAY”) to record on both sides.**
- 6 Press REC PAUSE/START, then start playing the source (for disc or tape).**
Recording starts.

To stop recording

Press ■ (TAPE B).

Note

You cannot listen to other sources while recording.

Tips

- When you record on both sides, be sure to start from the front side. If you start from the reverse side, recording stops at the end of the reverse side.
- For recording from the tape:
If you set the direction to “C↔” (or “RELAY”) when the tapes you use have different lengths, the tapes in each deck reverses independently.
- For recording from the radio:
If noise is heard while recording from the radio, move the respective antenna to reduce the noise.
- For recording from a disc to a tape manually:
You can press ◀◀ or ▶▶ (or ◀◀ or ▶▶+ on the remote) to select tracks during recording pause mode (after step 4 and before step 6).
- For recording from an album of MP3 audio tracks manually:
Press PLAY MODE repeatedly until “ALBM” lights up in the display and then press ALBUM +/- to select the album you want.
- You can mix the sound from the component connected to the GAME INPUT jacks with another function such as CD, tape, radio, VCR or turntable connected to this system. To record the mixed sound (page 26), press GAME MIXING after step 4 of “Manual Recording” and then press REC PAUSE/START to start recording.

Sound Adjustment

Adjusting the sound

You can reinforce the bass and create a more powerful sound.

Press X-GROOVE.

Each time you press the button, the display changes as follows:

X-GROOVE OFF



X-GROOVE ON

Tip

The default setting is “X-GROOVE ON”.

Selecting the preset effect

Press one of the Preset Effect buttons to select the preset effect you want.

The preset effect name appears in the display. See the chart “Preset effect options.”

Preset effect options

“SURR” lights up in the display if you select an effect with surround effects.

| Effect | For |
|--------|---|
| SALSA | standard music sources |
| REGGAE | |
| POP | |
| SAMBA | |
| TANGO | |
| ROCK | |
| JAZZ | |
| DANCE | |
| MOVIE | soundtracks and special listening situations |
| GAME | play station 1, 2 and other video game music source |

To cancel the effect

Press EFFECT ON/OFF repeatedly until “EFFECT OFF” appears in the display.

Tip

You can also select the preset effect including the personal file by pressing EQ on the remote repeatedly.

Adjusting the graphic equalizer and storing the personal file

You can adjust the sound by raising or lowering the level of specific frequency band, then store up to a personal file (P FILE) in the memory. Before adjustment, select the preset effect you want for your basic sound.

- 1 Press ← or → repeatedly to select a frequency band, then press ↑ or ↓ repeatedly to adjust the level.**

Frequency band Frequency level



- 2 Press and hold down P FILE until “P FILE MEMORY” appears in the display.**

The setting is stored automatically in the personal file. The previous setting stored at this memory location is erased and replaced by the new setting.

To call up the personal file

Press P FILE.

Tip

If you do not want to store a personal file, press ENTER after step 1.

Selecting the surround effect

Press SURROUND.

Each time you press the button, the display changes as follows:

SURROUND ON



SURROUND OFF

Note

When you select certain preset effect, the surround effect may be canceled.

Selecting the MP3 Booster effect

You can improve the sound quality of MP3 audio tracks during playback.

1 Press AMP MENU repeatedly to select "MP3 BOOSTER".

The last selected MP3 booster setting appears in the display.

2 Press ← or → repeatedly to select the setting you want.

The display changes as follows:

BOOSTER OFF ↔ BOOSTER ON

3 Press ENTER.

Note

You can only listen to MP3 Booster effect during playback of MP3 audio tracks.

Creating a party environment

(FST-ZX8/LBT-ZX8 only)

You can create a party environment by using X-ROUND for “moving” sound effect or/and FLASH for flashing effect.

To enjoy the X-ROUND mode, place your front and surround speakers at an equal distance from your listening position (see Example 2 of “Positioning the speakers for FST-ZX8/LBT-ZX8 only” on page 10).

Moving sound effect

— X-ROUND

- 1 Press X-ROUND ON/OFF repeatedly until the X-ROUND indicator lights up.

The last selected X-ROUND mode appears in the display.

- 2 Press MODE repeatedly to select the X-ROUND mode you want.

The display changes cyclically as follows:
MANUAL WAVE → MANUAL FADER
→ MANUAL BAL → AUTO WAVE →
AUTO FADER → AUTO BAL →
RANDOM POS → TWISTER

| Select | To output sound |
|---|--|
| MANUAL WAVE ¹⁾ , AUTO WAVE ²⁾ | In circular motion |
| MANUAL FADER ¹⁾ , AUTO FADER ²⁾ | From front speakers to surround speakers |
| MANUAL BAL ¹⁾ , AUTO BAL ²⁾ | From left speakers to right speakers |
| RANDOM POS | In random position |
| TWISTER | In circular motion like “twister” |

¹⁾ You can manually change the sound movement from one speaker to another speaker by turning the JOG clockwise or anticlockwise.

²⁾ You can change the speed of sound movement by turning the JOG clockwise or anticlockwise.

To cancel the X-ROUND effect

Press X-ROUND ON/OFF repeatedly until “X-ROUND OFF” appears in the display. The X-ROUND indicator turns off.

Notes

- If you cannot get the sound effect you want, check the speaker connections.
- When the headphones are connected to the PHONES jack, X-ROUND mode is automatically changed to “X-ROUND OFF” and you cannot change this setting.

Flashing sound effect

— FLASH

With the flash function, you can flash the sound output. The sound cuts off periodically.

Hold down FLASH during playback

The flashing effect is activated.

To cancel the flashing effect

Release FLASH.

To change the flash speed

Hold down FLASH and turn the JOG clockwise or counterclockwise to change the flash speed (1 ~ 20).

Tips

- You can activate the X-ROUND and FLASH effect simultaneously.
- The power illuminator will synchronize with the selected FLASH effect.

Listening to the sound in another room

— Multi Room

(FST-ZX8/LBT-ZX8 only)

You can place your front speakers in one room and your surround speakers in another room. Then, use the Multi Room function to select the speakers you want to turn on.

1 Press X-ROUND ON/OFF repeatedly until “X-ROUND OFF” appears in the display.

The X-ROUND indicator turns off.

2 Press SPEAKERS.

Each time you press the button, the corresponding speaker indicators light up and the display changes cyclically as follow:

SPEAKERS A → SPEAKERS B →
SPEAKERS A+B

| To select | Display |
|--------------------------------------|--------------|
| The front speakers | SPEAKERS A |
| The surround speakers | SPEAKERS B |
| Both the front and surround speakers | SPEAKERS A+B |

Notes

- When X-ROUND mode is selected, the Multi Room setting automatically changes to SPEAKERS A+B.
- When the headphones are connected to the PHONES jack, the Multi Room setting is automatically changed to “SPEAKERS A+B” and you cannot change this setting.

Enhancing the video game sound

— Game Sync

You need to connect a video game player (see “Hooking up optional components” on page 33).

Press GAME.

The “GAME” preset effect is selected automatically.

Tips

- If you press GAME while the system is turned off, the system turns on automatically and GAME is selected as the function.
- This operation cannot be performed in the Power Saving Mode (page 29).
- You can also press FUNCTION repeatedly to select “GAME”.

Mixing video game sound with other sound source

— Game Mixing

You can mix the sound from the component connected to the GAME INPUT jacks with another function such as CD, tape, radio, VCR or turntable connected to this system.

- 1 Select the source sound you want.**
- 2 Press GAME MIXING.**

Each time you press the button, the level of the game sound changes cyclically as follows:

MIXING LOW → MIXING MID →
MIXING HIGH → MIXING OFF

Notes

- Game Mixing is canceled when you press REC PAUSE/START.
- Game Mixing does not function during CD Synchro Recording.
- During Game Mixing, when “TAPE A” or “TAPE B” function is selected, you will not hear any sound output from GAME INPUT if you use the AMS function.

Tips

- To record the mixed sound, press GAME MIXING after step 4 of “Manual Recording” on page 20 and then press REC PAUSE/START to start recording.
- The GAME MIXING indicator lights up in the display while Game Mixing is activated and it will remain active while the power is on even if the function is changed.

Singing along

You can sing along with any stereo CD or tape. You need to connect an optional microphone.

- 1 Turn MIC LEVEL to MIN to turn down the microphone volume.**
- 2 Connect an optional microphone to MIC 1 or MIC 2 jacks.**
- 3 Start playing the music and adjust the volume.**
- 4 Adjust the microphone volume by turning MIC LEVEL.**

After you have finished

Turn MIC LEVEL to MIN and disconnect the microphone from MIC 1 or MIC 2 jacks.

Note

When “TAPE A” or “TAPE B” function is selected, you will not hear any sound output from microphone if you use the AMS function.

Tips

- If acoustic feedback (howling) occurs, move the microphone away from the speakers or change the direction of the microphone.
- If you want to record your voice through the microphone only, you can do so by selecting the “CD” function and not playing any disc.
- When high level sound signals are input, the system automatically adjust the recording level to prevent distortion of the recorded sound signals (Auto Level Control Function).

Falling asleep to music

— Sleep Timer

You can set the system to turn off after a certain time, so that you can fall asleep to music.

Press SLEEP repeatedly.

Each time you press the button, the minute display (the turn-off time) changes cyclically as follows:

AUTO* → 90 → 80 → 70 → ... → 10 → OFF

* The system automatically turns off in 100 minutes or after the current disc or tape finishes playing.

Other operations

| To | Do this |
|-----------------------------|--|
| Check the remaining time** | Press SLEEP once. |
| Change the time to turn off | Press SLEEP repeatedly to select the time you want. |
| Cancel the Sleep Timer | Press SLEEP repeatedly until "SLEEP OFF" appears in the display. |

** You cannot check the remaining time if you select "AUTO".

Notes

- Do not set to "AUTO" during CD Synchro Recording on a tape.
- The "SLEEP" lights up in the display when the Sleep Timer is activated.

Tip

You can use the Sleep Timer, even if you have not set the clock.

Waking up to music

— Play Timer

You can wake up to music at a preset time everyday. Make sure you have set the clock (see "Setting the clock" on page 11).

1 Prepare the music source you want to play.

- Disc: Load a disc. To start from a specific track, make a program (see "Creating your own program" on page 15).
- Tape: Load a tape with the side you want to play facing forward.
- Radio: Tune in the preset station you want (see "Listening to the radio" on page 17).

2 Turn VOLUME +/- (or press VOLUME + or - on the remote) to adjust the volume.

3 Press CLOCK/TIMER SET.

"PLAY SET?" flashes in the display.

4 Press ENTER.

"ON" appears and the hour indication flashes in the display.

5 Set the time to start playback.

Press ↑ or ↓ (or ►►+ or -◄◄ on the remote) repeatedly to set the hour, then press ENTER.

The minute indication flashes in the display.

Press ↑ or ↓ (or ►►+ or -◄◄ on the remote) repeatedly to set the minute, then press ENTER.

6 Set the time to stop playback following the same procedure as step 5.

7 Press ↑ or ↓ (or ►►+ or -◄◄ on the remote) repeatedly until the music source you want appears in the display.

The display changes as follows:



8 Press ENTER.

The type of timer, followed by start time, stop time and the music source appears in the display.

9 Press I/⏻ to turn off the system.

Other operations

| To | Do this |
|--------------------|--|
| Check the setting | <ol style="list-style-type: none">1 Press CLOCK/TIMER SELECT.2 Press ↑ or ↓ (or ►►+ or -◄◄ on the remote) repeatedly until "PLAY SELECT?" flashes in the display, then press ENTER. |
| Change the setting | Start from step 1. |
| Cancel the timer | <ol style="list-style-type: none">1 Press CLOCK/TIMER SELECT.2 Press ↑ or ↓ (or ►►+ or -◄◄ on the remote) repeatedly until "TIMER OFF?" flashes in the display, then press ENTER. |

Notes

- You cannot select the Play Timer and Timer Recording at the same time.
- If you use Play Timer and Sleep Timer at the same time, the Sleep Timer has priority.
- The Play Timer will not be activated if the system is on.

Tips

- The system turns on 15 seconds before the preset time.
- When the Play Timer is selected, "PLAY" lights up in the display.

Timer recording radio programs

You can record from a preset radio station at the specified time.

To timer record, you must first preset the radio station (see "Presetting radio stations" on page 16) and set the clock (see "Setting the clock" on page 11).

- 1 Tune in the preset radio station (see "Listening to a preset station" on page 17).**
- 2 Press CLOCK/TIMER SET.**
"PLAY SET?" flashes in the display.
- 3 Press ↑ or ↓ (or ►►+ or -◄◄ on the remote) repeatedly to select "REC SET?", then press ENTER.**
"ON" appears and the hour indication flashes in the display.
- 4 Set the time to start recording.**
Press ↑ or ↓ (or ►►+ or -◄◄ on the remote) repeatedly to set the hour, then press ENTER.
The minute indication flashes in the display.
Press ↑ or ↓ (or ►►+ or -◄◄ on the remote) repeatedly to set the minute, then press ENTER.
- 5 Set the time to stop recording following the same procedure as step 4.**
The type of timer, followed by start time, stop time and the preset radio station to be recorded (e.g., "TUNER FM 5") appears in the display.
- 6 Load a recordable tape into deck B.**

7 Press DIRECTION repeatedly to select “←→” to record on one side. Select “↔” (or “RELAY”) to record on both sides.

If you want to record on the reverse side, press ◀ (TAPE B). Then, press ■ (TAPE B).

When you record on both sides, be sure to start from the front side. If you start from the reverse side, recording stops at the end of the reverse side.

8 Press I/⏻ to turn off the system.

When the recording starts, the volume level is set to minimum.

Other operations

| To | Do this |
|--------------------|---|
| Check the setting | <ol style="list-style-type: none"> 1 Press CLOCK/TIMER SELECT. 2 Press ↑ or ↓ (or ►►+ or ◀◀ on the remote) repeatedly until “REC SELECT?” flashes in the display, then press ENTER. |
| Change the setting | Start from step 1. |
| Cancel the timer | <ol style="list-style-type: none"> 1 Press CLOCK/TIMER SELECT. 2 Press ↑ or ↓ (or ►►+ or ◀◀ on the remote) repeatedly until “TIMER OFF?” flashes in the display, then press ENTER. |

Notes

- You cannot select the Play Timer and Timer Recording at the same time.
- If you use the Timer Recording and Sleep Timer at the same time, the Sleep Timer has priority.
- The Timer Recording will not activated if the system is on.
- Do not operate the system from the time the system turns on until the recording starts (about 15 seconds before preset time).

Tips

- The system turns on 15 seconds before the preset time.
- When the Timer Recording is selected, the “REC” lights up in the display.

Display

Turning off the display

— Power Saving Mode

The demonstration display and the clock display can be turned off to minimize the amount of power consumed during standby mode (Power Saving Mode).

Press DISPLAY repeatedly while the system is turned off until the demonstration display and the clock display disappears.

To cancel Power Saving Mode

Press DISPLAY once to show the demonstration display or twice to show the clock display. Each time you press the button, the display changes cyclically as follows: Demonstration display¹⁾ → Clock display²⁾ → Power Saving Mode

¹⁾The display changes and the indicators flashes even when the system is turned off.

²⁾“-.-” appears in the display if you have not set the clock.

Note

You cannot do the following operations in Power Saving Mode.

- setting the clock (page 11)
- changing the AM tuning interval (page 17)
- turning on the system by pressing the following buttons
 - (a) TUNER/BAND
 - (b) GAME
 - (c) ◀/▶ (TAPE A)
 - (d) ◀/▶ (TAPE B)
 - (e) ►|| (CD)
 - (f) CD on the remote
 - (g) TAPE on the remote
- changing “CD POWER” settings (page 17)
- switching the VIDEO/MD function (page 34)

Tips

- The timer continues to operate in Power Saving Mode.
- The I/⏻ indicator lights up even in Power Saving Mode.

Viewing information about the disc in the display

You can check the playing time and remaining time of the current track or current disc. When a CD-TEXT disc or a disc with MP3 audio tracks is loaded, you can check the information stored on the disc, such as the titles. When the system detects CD-TEXT discs, “CD TEXT” lights up in the display.

Checking the remaining time

Press DISPLAY repeatedly during playback.

Each time you press the button, the display changes cyclically as follows:
Playing time of the current track → Remaining time of the current track¹⁾ → Remaining time of the current disc²⁾ → Title of the current track³⁾ → Title of the current album (for a few seconds)⁴⁾ → Clock display¹²⁾ (for 8 seconds) → Effect status (for 8 seconds)

Checking the total playing time

Press DISPLAY repeatedly when playback is stopped (except for Program Mode).

Each time you press the button, the display changes cyclically as follows:
Total number of tracks⁵⁾ or albums⁶⁾ or the total playing time⁷⁾ → Title of current album⁵⁾ or title of current disc⁸⁾ → Clock display¹²⁾ (for 8 seconds) → Effect status (for 8 seconds)

Press DISPLAY repeatedly when playback is stopped during Program Play and there is a program.

Each time you press the button, the display changes cyclically as follows:
The last track number of the program and the total playing time⁹⁾ → Total number of programmed tracks (for 8 seconds)¹⁰⁾ → Disc title¹¹⁾ → Clock display¹²⁾ (for 8 seconds) → Effect status (for 8 seconds)

- 1) “--:--” appears while an MP3 audio track is played back.
- 2) “--:--” appears in the following cases:
 - while an MP3 audio track is played back.
 - All play modes except “1 DISC” and “ALBM”.
- 3) Only for CD-TEXT disc and a disc with MP3 audio tracks.
 - When the CD-TEXT disc contains more than 20 tracks, the current track title is not displayed from track 21 onwards.
- 4) Only for disc with MP3 audio tracks.
- 5) For disc with MP3 audio tracks in “ALBM” and “ALBM SHUF” modes.
- 6) For disc with MP3 audio tracks in play modes other than “ALBM” and “ALBM SHUF”.
- 7) For audio CDs.
- 8) For disc with MP3 audio tracks in play modes other than “ALBM”, “ALBM SHUF” and CD-TEXT discs.
- 9) “--:--” appears in the following cases:
 - When the audio CD contains 21 tracks or more, and the track number which exceeds 20 is selected.
 - When the total program exceeds 100 minutes.
 - When the program list contains MP3 audio tracks.
- 10) “NO STEP” appears if there is no program.
- 11) Only for CD-TEXT disc and a disc with MP3 audio tracks.
- 12) “--:--” appears in the display if you have not set the clock.

Note

Some characters may not be displayed for track title, album title or disc title.

Changing the power illuminator

You can select the power illuminator as you want.

Press ILLUMINATION repeatedly to select the power illuminator you want when the system is turned on.

Each time you press the button, the power illuminator changes cyclically as follows:

PATTERN 1 → PATTERN 2 → PATTERN 3
→ PATTERN 4 → PATTERN OFF

When X-ROUND mode is selected (FST-ZX8/LBT-ZX8 only)

Each time you press the button, the power illuminator changes cyclically as follows:

X-PATTERN* ↔ PATTERN OFF

* The power illuminator will synchronize with the selected X-ROUND effect.

Notes

- When you turn VOLUME +/- (or press VOLUME +/- on the remote), power illuminator shows the current volume level.
- During the demonstration display, you can turn on or off power illuminator by pressing ILLUMINATION.

Changing the spectrum analyzer display

1 Press AMP MENU repeatedly to select "SPECTRUM".

The last selected spectrum appears in the display.

2 Press ← or → repeatedly to select the setting you want.

The display changes as follows:



When X-ROUND mode is selected (FST-ZX8/LBT-ZX8 only)

The display changes as follows:

X-POSITION* ↔ SPECTRUM OFF

* The spectrum analyzer display will synchronize with the selected X-ROUND effect.

3 Press ENTER.

Adjusting the brightness of the display

- 1** Press **AMP MENU** repeatedly to select "DIMMER".

The last selected dimmer appears in the display.

- 2** Press **←** or **→** repeatedly to select the setting you want.

The display changes as follows:

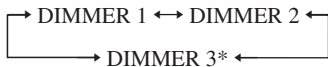

* DIMMER 3 is the darkest.

- 3** Press **ENTER**.

Optional Components

Hooking up optional components

To enhance your system, you can connect optional components. Refer to the operating instructions provided with each component.

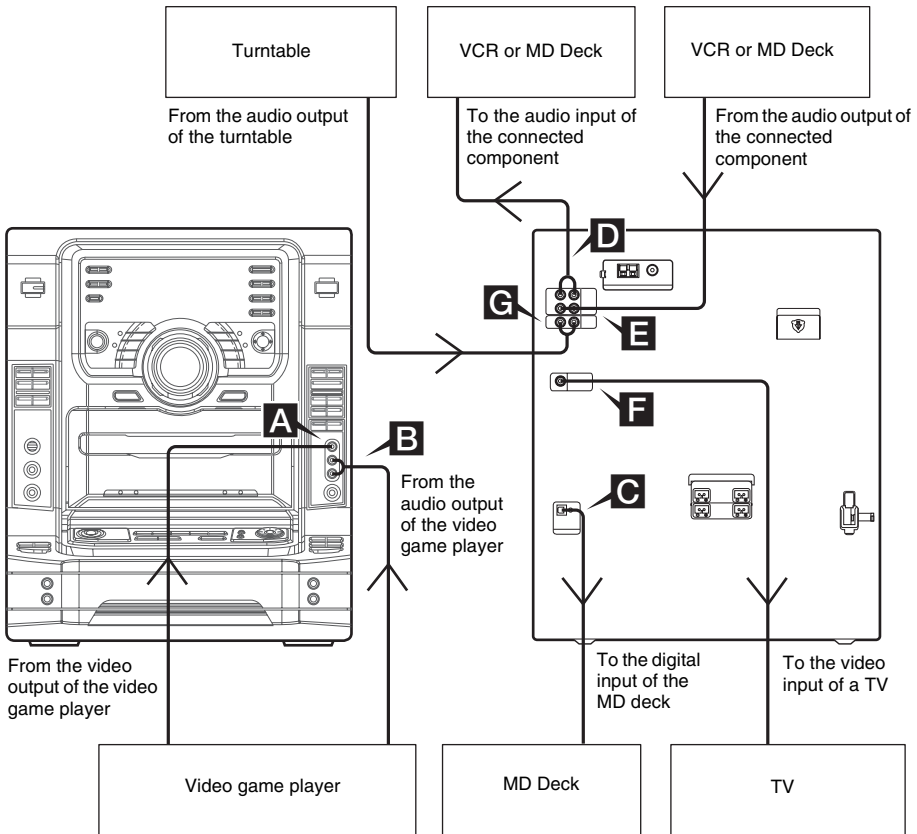

A GAME INPUT VIDEO jack

Use video cable (not supplied) to connect the video output of the optional video game player to this jack. You can then output video through this system.

Note

The video game player image may appear on the TV screen even if the system is turned off.

B GAME INPUT AUDIO L/R jacks

Use audio cords (not supplied) to connect the audio output of the optional video game player to these jacks. You can then output audio through this system.

C CD DIGITAL OUT jack

Use a digital optical cable (square, not supplied) to connect the digital input of the optional MD deck to this jack. You can then record digital audio from this system.

Note

There is no digital audio output from this jack during playback of MP3 audio tracks.

D VIDEO/MD OUT L/R jacks

Use audio cords (not supplied) to connect the audio input of the optional component (such as VCR or an MD deck) to these jacks. You can then output audio to that component from this system.

Note

There is no audio output from this jack during VIDEO or MD function when GAME MIXING is turned off.

E VIDEO/MD IN L/R jacks

Use audio cords (not supplied) to connect the audio output of the optional component (such as VCD or MD deck) to these jacks. You can then output audio through this system.

F VIDEO OUT jack

Use a video cable (not supplied) to connect the video input of TV to this jack.

G PHONO IN L/R jacks

Use audio cords (not supplied) to connect the audio output of the turntable to these jacks. You can then output audio through this system.

Listening to audio from a connected component

| To | Do this |
|--|--|
| Listen to a connected VCR | <ol style="list-style-type: none">1 Connect the audio cords. See “Hooking up optional components” on page 33.2 Press FUNCTION repeatedly until “VIDEO” appears in the display. Start playing the connected VCR. |
| Listen to a connected MD deck | <ol style="list-style-type: none">1 Connect the audio cords. See “Hooking up optional components” on page 33.2 Press I/⏻ to turn off the system.3 Hold down FUNCTION and press I/⏻. Release I/⏻ first, then release FUNCTION. The system turns on automatically and switches the function from VIDEO to MD. Start playing the connected MD deck. |
| Listen to the sound of a connected video game player | <ol style="list-style-type: none">1 Press GAME.2 Select the preset effect. See “Selecting the preset effect” on page 22. |
| Listen to a connected turntable | <ol style="list-style-type: none">1 Connect the audio cords. See “Hooking up optional components” on page 33.2 Press FUNCTION repeatedly until “PHONO” appears in the display. Start playing the connected turntable. |

Notes

- If you want to switch back to “VIDEO” function, repeat step 2 and 3 of “Listen to a connected MD deck”.
- If the sound is distorted or too loud when “VIDEO” function is selected, switch to “MD” function. (See “Listen to a connected MD deck”).
- Use buttons on the system for the operation.

Recording on a connected component

| To | Do this |
|--|--|
| Make a digital recording from an audio CD onto a connected MD deck | <ol style="list-style-type: none"> 1 Connect the optional optical cable from CD DIGITAL OUT jack to digital audio input of the MD deck. See “Hooking up optional components” on page 33. 2 Start recording. Refer to the operating instructions provided with the connected MD deck. |
| Make an analog recording from disc, tape, radio, connected turntable or video game player onto a connected MD deck | <ol style="list-style-type: none"> 1 Connect the optional audio cords from VIDEO/MD OUT L/R jacks to the analog audio input of the MD deck. See “Hooking up optional components” on page 33. 2 Start recording. Refer to the operating instructions provided with connected component. |

Note

You cannot record from an MP3 audio track digitally. When you record from an MP3 audio track to a connected MD deck, make an analog recording on MD deck.

Connecting external antennas

Connect an external antenna to improve the reception.

FM antenna

Connect an optional FM external antenna. You can also use the TV antenna instead.

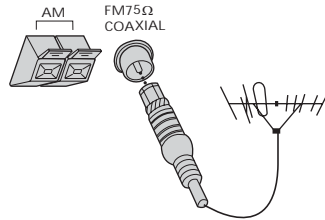

AM antenna

Connect a 6 to 15 meters insulated wire to the AM antenna terminal. Leave the supplied AM loop antenna connected.

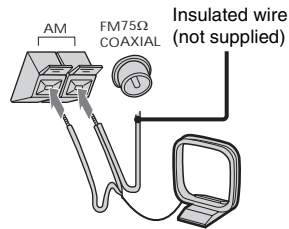

Troubleshooting

Problems and remedies

Should you encounter a problem with your system, do the following:

- 1 Make sure the power cord and speaker cords are correctly and firmly connected.
- 2 Find your problem in the troubleshooting checklist below and take the indicated corrective action.

If the problem persists after doing all of the above, consult your nearest Sony dealer.

When the I/⏻ indicator flashes

Immediately unplug the power cord and check the following items.

- Is the voltage selector set to the correct voltage? Check the voltage for your region, then make sure the voltage selector is set correctly.
- Are the + and – speaker cords short-circuited?
- Are you using only the prescribed speakers?
- Is anything blocking the ventilation holes on the rear of the system?

After checking the above items and fixing any problems, connect the power cord again and turn on the system. If the I/⏻ indicator still flashes, or if the cause of the problem cannot be found even after checking all the above items, consult your nearest Sony dealer.

General

The display starts flashing as soon as you plug in the power cord even though you have not turned on the power.

- The demonstration mode started. Press I/⏻ (see step 5 of “Hooking up the system” on page 8).

The clock/timer setting is canceled.

- The power cord is disconnected or a power failure occurs. Redo “Setting the clock” (page 11). If you have set the timer, redo “Waking up to music” (page 27) and “Timer recording radio programs” (page 28).

The radio presetting is canceled.

- The power cord is disconnected or a power failure occurs for longer than half a day. Redo “Presetting radio stations” (page 16).

There is no sound.

- Turn VOLUME +/- clockwise or press VOLUME + on the remote.
- The headphones are connected to the PHONES jack.
- There is no audio output during Timer Recording.
- The tape is in AMS operation during “TAPE A” or “TAPE B” function.
- Check the Multi Room setting (see “Listening to the sound in another room” on page 25).

“--:--” appears in the display.

- A power failure has occurred. Set the clock (page 11) and timer settings (pages 27 – 29) again.

There is no microphone sound.

- Turn VOLUME +/- (or press VOLUME + or – on the remote) or MIC LEVEL to adjust the microphone volume.
- Make sure the microphone is connected to the MIC 1 or MIC 2 jack correctly.
- The tape is in AMS operation during “TAPE A” or “TAPE B” function.

Sound comes from one channel, or unbalanced left and right volume.

- Place the speakers as symmetrically as possible.
- Check that the speakers are connected securely and correctly.
- Turn off the X-ROUND effect (page 24).

Sound lacks bass.

- Check that the speaker’s + and – terminals are connected correctly.

There is severe hum or noise.

- A TV or VCR is placed too close to the system. Move the system away from the TV or VCR.
- Move the system away from the source of noise.
- Connect the system to a different wall outlet.
- Install a noise filter (commercially available) to the power cord.

The sound from the component connected to the VIDEO/MD IN L/R jacks is distorted.

- If “VIDEO” appears in the display when you press FUNCTION repeatedly, switch to “MD” function (see “Listening to audio from a connected component” on page 34).

The timer cannot be set.

- Set the clock again (page 11).

The timer does not function.

- Check the timer setting (page 27 – 29) and set the clock correctly (page 11).
- Cancel the Sleep Timer (page 27).
- You cannot activate the Play Timer and Timer Recording simultaneously.

The remote does not function.

- Remove the obstacle between the remote and the system.
- Move the remote closer to the system.
- Point the remote at the system's sensor.
- Replace the batteries (R6/size AA).
- Locate the system away from the fluorescent light.

There is acoustic feedback.

- Decrease the volume level.
- Move the microphone away from the speakers or change the direction of the microphone.

The color irregularity on a TV screen persists.

- Turn off the TV set once, then turn it on after 15 to 30 minutes. If the color irregularity still persists, place the speakers farther away from the TV set.

CD/MP3 player

The disc tray does not open and "LOCKED" appears on the display.

- Contact your Sony dealer or local authorized Sony service facility.

The disc tray does not close.

- Place the disc correctly.
- Always close the tray by pressing **▲ OPEN/CLOSE** on the system. Trying to close the tray with your fingers may cause problems with the system.

The disc does not eject.

- You cannot eject the disc during CD Synchro Recording. Press **■ (TAPE B)** to cancel the CD Synchro Recording, then press **▲ OPEN/CLOSE** on the system to eject the disc.
- Consult your nearest Sony dealer.

Playback does not start.

- Open the disc tray and check whether a disc is loaded.
- Wipe the disc clean (page 40).
- Replace the disc.
- Place the disc that this system can play.
- Place the disc correctly.
- Place the disc in the tray with the label side up.
- Remove the disc and wipe away the moisture on the disc, then leave the system turned on for a few hours until the moisture evaporates.
- Press **▶||** (or **▶** on the remote) to start playback.

Disc access takes a long time.

- Set "CD POWER ON" by CD power manage function (page 17).

The sound skips.

- Wipe the disc clean (page 40).
- Replace the disc.
- Try moving the system to a place without vibration (e.g., on top of a stable stand).
- Try moving the speakers away from the system, or placing them on separate stands. When you listen to a track with bass sounds at high volume, the speaker vibration may cause the sound to skip.

Playback does not start from the first track.

- The system is in Program Play or Shuffle Play mode. Press **PLAY MODE** repeatedly until "ALL DISCS", "1 DISC" or "ALBM" lights up in the display.

MP3 audio track cannot be played back.

- Recording was not performed according to the ISO 9660 level 1, level 2, or Joliet in the expansion format.
- The MP3 audio track does not have the extension ".MP3".
- The data is not stored in MP3 format even though it has extension ".MP3".
- The discs containing tracks other than MPEG 1, 2 and 2.5 Audio Layer 3 files cannot be played back.
- The system can play to a depth of 8 directories.

MP3 audio tracks take a longer time to playback than others.

- After the system reads all tracks on the disc, playback may take more time than usual if
 - the number of albums or tracks on the disc is very large.
 - the album and track organization structure is very complex.

The disc title, album title, track title, ID3 tag and the CD-TEXT characters do not appear properly.

- Use a disc that conforms with ISO 9660 level 1, level 2, or Joliet in the expansion format.
 - The ID3 tag is not version 1 or version 2.
 - The character code that can be displayed by this system are as follows.
 - Upper cases (A to Z)
 - Lower cases (a to z)
 - Number (0 to 9)
 - Symbols (<>*, - / [] \ _)
- Other characters may not be displayed correctly.
-

Tuner

There is severe hum or noise (“TUNED” or “ST” flashes up in the display).

- Set the proper band and frequency (page 16).
- Connect the antenna properly (page 9).
- Find a place and an orientation that provide good reception, then set up the antenna again. If you cannot obtain good reception, we recommend you connect a commercially available external antenna.
- The supplied FM lead antenna receives signals along its entire length, so make sure you extend it fully.
- Locate the antennas as far away from the speaker cords as possible.
- Try turning off surrounding electrical equipment.
- Set “CD POWER OFF” by CD power manage function (page 17).

A stereo FM program cannot be received in stereo.

- Press FM MODE until “MONO” disappears.
-

Tape deck

The tape does not record or play, or there is a decrease in sound level.

- The tape heads are dirty. (See “Cleaning the tape heads” on page 41).
 - The record/playback heads are magnetised. (See “Demagnetising the tape heads” on page 41).
-

The tape does not erase completely.

- The record/playback heads are magnetised. (See “Demagnetising the tape heads” on page 41).

There is excessive wow or flutter, or the sound drops out.

- The capstans or pinch rollers are dirty. (See “Cleaning the tape heads” on page 41).
-

Noise increases or the high frequencies are erased.

- The record/playback heads are magnetised. (See “Demagnetising the tape heads” on page 41).
-

The tape does not record.

- The tab has been removed from the tape. Cover the broken tab with adhesive tape (page 41).
 - The tape has reeled to the end.
-

If the system still does not operate properly after performing the above measures or other troubles does not described above occur, reset the system as follows:

Use buttons on the system for the operation.

- 1** Unplug the power cord.
- 2** Plug the power cord back in.
- 3** Press I/⏻ to turn on the system.
- 4** Press ■ (TAPE B), TUNER ENTER and I/⏻ at the same time.

The system is reset to the factory settings. You should set the settings you made, such as the preset stations, clock, and timer.

Messages

One of the following messages may appear or flash in the display during operation.

CD/MP3

No Disc

There is no disc on the disc tray.

Cannot Edit

- You pressed EDIT before the information of a disc is read.
- The selected disc is a disc with MP3 audio tracks.
- The selected audio CD contains more than 20 tracks.

NO STEP

You have cleared all the steps you programmed.

OVER

You have reached the end of the disc while pressing **▶▶** during playback or pause.

Push STOP!

You have pressed PLAY MODE during playback.

Step Full!

You tried to program more than 25 steps.

Reading

The system is reading information of the disc. Some buttons are not available.

Tape

No Tab

You cannot record the tape because the tab has been removed from the tape.

No Tape

There is no tape in the tape deck.

Timer

OFF TIME NG!

The on time and off time of Play Timer or Timer Recording is same.

SET CLOCK!

You pressed CLOCK/TIMER SELECT before the clock is set.

SET TIMER!

You pressed CLOCK/TIMER SELECT before Play Timer or Timer Recording is set.

PUSH SELECT!

You tried to set the clock or timer during timer operation.

Sound Adjustment

Not in Use

You pressed X-ROUND ON/OFF or SPEAKERS when the headphones are connected to the PHONES jack.

Additional Information

Precautions

On operating voltage

Before operating the system, check that the operating voltage of your system is identical with the voltage of your local power supply.

On safety

- The system is not disconnected from the AC power source (mains) as long as it is connected to the wall outlet, even if the system itself has been turned off.
- Unplug the system from the wall outlet (mains) if it is not to be used for an extended period of time. To disconnect the power cord (mains lead), pull it out by the plug. Never pull the cord itself.
- Should any solid object or liquid fall into the system, unplug the system and have it checked by qualified personnel before operating it any further.
- For customers in United States
One blade of the plug is wider than other for the purpose of safety and will fit to the wall outlet only one way. If you are unable to insert the plug fully into the outlet, contact your dealer.
- AC power cord must be changed only at the qualified service shop.

On placement

- Do not place the system in an inclined position.
- Do not place the system in locations where it is:
 - Extremely hot or cold
 - Dusty or dirty
 - Very humid
 - Subject to vibrations
 - Subject to direct sunlight.
- Use caution when placing the system or speakers on surfaces that have been specially treated (with wax, oil, polish, etc.) as staining or discoloration of the surface may result.

On heat buildup

- Although the system heats up during operation, this is not a malfunction.
- Place the system in a location with adequate ventilation to prevent heat buildup in the system.
- If you continuously use this system at a high volume, the cabinet temperature of the top, side and bottom rises considerably. To avoid burning yourself, do not touch the cabinet.
- To prevent a malfunction, do not cover the ventilation hole for the cooling fan.

On operation

- If the system is brought directly from a cold to a warm location, or is placed in a very damp room, moisture may condense on the lens inside the system. Should this occur, the system will not operate properly. Remove the disc and leave the system turned on for about an hour until the moisture evaporates.
- When you move the system, take out any disc.

If you have any question or problem concerning your system, please consult your nearest Sony dealer.

Notes on discs

- Before playing, clean the disc with a cleaning cloth. Wipe the disc from the center out.
- Do not use solvents such as benzene, thinner, commercially available cleaners or anti-static spray intended for vinyl LPs.
- Do not expose the disc to direct sunlight or heat sources such as hot air ducts, nor leave it in a car parked in direct sunlight.
- Do not use discs encircled with a protection ring. This may cause a malfunction to the system.
- When using discs that have glue or similar tacky substance on the label side of the disc or that used a special ink when the label was printed, there is a chance that the disc or label may become attached to parts inside this system. When this occurs, it may not be possible to remove the disc, and may also cause this system to malfunction. Be sure to check that the label side of the disc is not sticky before using.
The following types of disc should not be used:
 - Rental or used discs with attached seals where the glue extends beyond the seal. The perimeter of the seal on the disc is tacky.
 - Discs that have labels printed using a special ink that feels tacky when touched.
- Discs with non-standard shapes (e.g., heart, square, star) cannot be played on this system. Attempting to do so may damage the system. Do not use such discs.

Cleaning the cabinet

Clean the cabinet, panel and controls with a soft cloth slightly moistened with mild detergent solution. Do not use any type of abrasive pad, scouring powder or solvent such as thinner, benzene or alcohol.

To save a tape permanently

To prevent a tape from being accidentally recorded over, break off the tape tab from side A or B as illustrated.

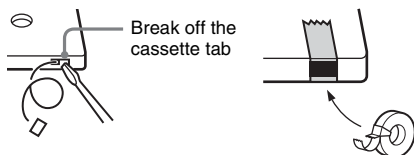

If you later want to reuse the tape for recording, cover the broken tab with adhesive tape.

Before placing a tape in the tape deck

Take up any slack in the tape deck. Otherwise, the tape may get entangled in the parts of the tape deck and become damaged.

When using a tape longer than 90 minutes

The tape is very elastic. Do not change the tape operations such as playback, stop, and fast-winding frequently. The tape may get entangled in the tape deck.

Cleaning the tape heads

Clean the tape heads after every 10 hours of use. Be sure to clean the tape heads before you start an important recording or after playing an old tape. Use a separately sold dry-type or wet-type cleaning cassette. For details, refer to the instructions of the cleaning tape.

Demagnetising the tape heads

Demagnetise the tape heads and the metal parts that have contact with the tape after every 20 to 30 hours of use with a separately sold demagnetising tape. For details, refer to the instructions of the demagnetising tape.

Specifications

AUDIO POWER SPECIFICATION (LBT-ZX8 USA model only)

POWER OUTPUT AND TOTAL HARMONIC DISTORTION:

With 6-ohm loads, both channels driven, from 120 Hz – 10 kHz; rates 140 watts per channel minimum RMS power, with no more than 10% total harmonic distortion from 250 milliwatts to rated output.

Continuous RMS power output (reference):

180×2 + 180×2 watts
(6 ohms at 1 kHz, 10% THD)

(LBT-ZX6 USA model only)

POWER OUTPUT AND TOTAL HARMONIC DISTORTION:

With 6-ohm loads, per channel driven, from 120 Hz – 10 kHz; rates 270 watts per channel minimum RMS power, with no more than 10% total harmonic distortion from 250 milliwatts to rated output.

Amplifier section

FST-ZX8

Mexican models:

The following measured at AC 127 V, 60 Hz
DIN power output (rated): 140×2 + 140×2 watts
(6 ohms at 1 kHz, DIN)

Continuous RMS power output (reference):
180×2 + 180×2 watts
(6 ohms at 1 kHz, 10% THD)

Other models:

The following measured at AC 120, 220, 240 V,
50/60 Hz
DIN power output (rated): 140×2 + 140×2 watts
(6 ohms at 1 kHz, DIN)

Continuous RMS power output (reference):
180×2 + 180×2 watts
(6 ohms at 1 kHz, 10% THD)

FST-ZX6

Mexican models:

The following measured at AC 127 V, 60 Hz
DIN power output (rated): 220 + 220 watts (4 ohms at 1 kHz, DIN)
Continuous RMS power output (reference):
280 + 280 watts (4 ohms at 1 kHz, 10% THD)

Other models:

The following measured at AC 120, 220, 240 V, 50/60 Hz
DIN power output (rated): 220 + 220 watts (4 ohms at 1 kHz, DIN)
Continuous RMS power output (reference):
280 + 280 watts (4 ohms at 1 kHz, 10% THD)

Inputs

PHONO IN (phono jacks):

sensitivity 3 mV,
impedance 47 kOhms
MIC (phone jack):
sensitivity 1 mV,
impedance 10 kOhms

GAME INPUT AUDIO L/R (phono jacks):

sensitivity 250 mV,
impedance 47 kOhms

GAME INPUT VIDEO (phono jack):

1 Vp-p, 75 ohms

VIDEO/MD IN L/R (phono jacks):

sensitivity 250 mV/
450 mV, impedance
47 kOhms

Outputs

PHONES (stereo phone jack):

accepts headphones of
8 ohms or more

VIDEO/MD OUT L/R (phono jacks):

voltage 250 mV,
impedance 1 kOhm

VIDEO OUT (phono jack):

max. output level 1 Vp-p,
load impedance 75 ohms

FRONT SPEAKER:

FST-ZX8/LBT-ZX8:

FRONT L/R

Use only the supplied
speaker SS-ZX8

SURROUND L/R

Use only the supplied
speaker SS-ZX8

FST-ZX6/LBT-ZX6:

FRONT L/R

Use only the supplied
speaker SS-ZX6

CD/MP3 player section

| | |
|---|---|
| System | Compact disc and digital audio system |
| Laser | Semiconductor laser ($\lambda=780$ nm) Emission duration: continuous |
| Laser Output | Max. 44.6 μ W* *This output is the value measured at a distance of 200 mm from the objective lens surface on the Optical Pick-up Block with 7 mm aperture. |
| Frequency response | 2 Hz – 20 kHz (± 0.5 dB) |
| Wave length | 780 – 790 nm |
| Signal-to-noise ratio | More than 90 dB |
| Dynamic range | More than 90 dB |
| OPTICAL CD DIGITAL OUT (Square optical connector jack, rear panel) | |
| Wave length | 660 nm |
| Output level | -18 dBm |

Tape deck section

| | |
|--------------------|---|
| Recording system | 4-track 2-channel, stereo |
| Frequency response | 50 – 13,000 Hz (± 3 dB), using Sony TYPE I tapes |
| Wow and flutter | $\pm 0.15\%$ W. Peak (IEC) 0.1% W. RMS (NAB) $\pm 0.2\%$ W. Peak (DIN) |

Tuner section

FM stereo, FM/AM superheterodyne tuner

FM tuner section

| | |
|------------------------|--------------------|
| Tuning range | 87.5 – 108.0 MHz |
| Antenna | FM lead antenna |
| Antenna terminals | 75 ohms unbalanced |
| Intermediate frequency | 10.7 MHz |

AM tuner section

| | |
|------------------------|---|
| Tuning range | 530 – 1,710 kHz (with the tuning interval set at 10 kHz) 531 – 1,710 kHz (with the tuning interval set at 9 kHz) |
| Antenna | AM loop antenna |
| Antenna terminals | External antenna terminal |
| Intermediate frequency | 450 kHz |

Speaker

Speaker SS-ZX8 for FST-ZX8/LBT-ZX8

| | |
|--------------------|--------------------------------|
| Speaker system | 2-way, bass-reflex type |
| Speaker units | |
| Woofer: | 22 cm, cone type |
| Tweeter: | 6.5 cm, cone type |
| Rated impedance | 6 ohms |
| Dimensions (w/h/d) | Approx. 290 × 353 × 482 mm |
| Mass | Approx. 9.5 kg net per speaker |

Speaker SS-ZX6 for FST-ZX6/LBT-ZX6

| | |
|----------------------|-------------------------------------|
| Speaker system | 3-way BUILT IN SW, bass-reflex type |
| Speaker units | |
| Super Woofer/Woofer: | 17 cm/17 cm, cone type |
| Tweeter: | 2.5 cm, horn type |
| Rated impedance | 6 ohms |
| Dimensions (w/h/d) | Approx. 250 × 530 × 362 mm |
| Mass | Approx. 9.5 kg net per speaker |

General

Power requirements

| | |
|------------------------|--|
| North American models: | 120 V AC, 60Hz |
| Mexican models: | 127 V, 60 Hz |
| Other models: | 120 V, 220 V or 230 – 240 V AC, 50/60 Hz |
| | Adjustable with voltage selector |

Power consumption

FST-ZX8/LBT-ZX8: 330 watts

FST-ZX6/LBT-ZX6: 240 watts

Dimensions (w/h/d) (Main Unit)
Approx. 362 × 437 × 465 mm

Mass (Main Unit)

FST-ZX8/LBT-ZX8: Approx. 19.0 kg

FST-ZX6/LBT-ZX6: Approx. 15.6 kg

Supplied accessories:

- AM loop antenna (1)
- FM lead antenna (1)
- Remote Commander (1)
- Batteries (2)
- Speaker cords:
 - FST-ZX6/LBT-ZX6 only 2m (2)
 - FST-ZX8/LBT-ZX8 only
 - grey (10 m) (2)
 - white (3 m) (2)
- Speaker pads:
 - FST-ZX6/LBT-ZX6 only (8)
 - FST-ZX8/LBT-ZX8 only (16)

Design and specifications are subject to change without notice.

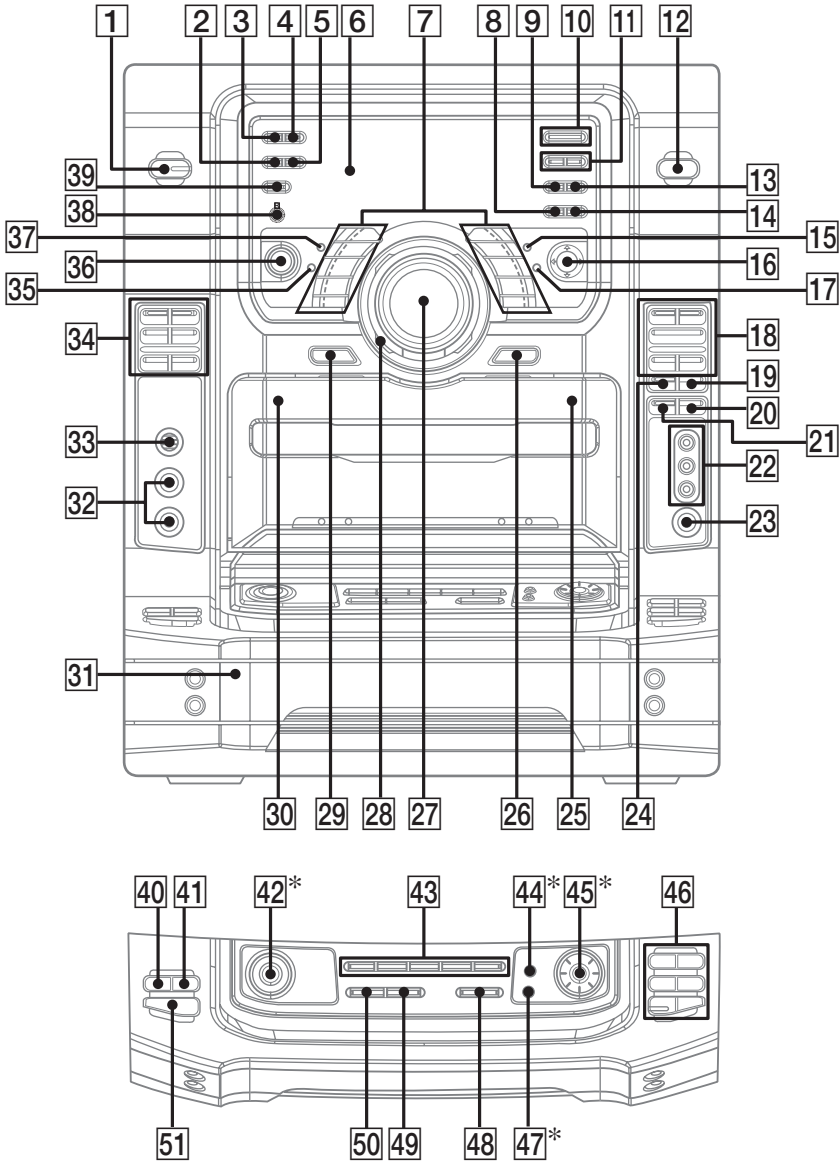

* FST-ZX8/LBT-ZX8 only.

Remote control

ALPHABETICAL ORDER

A - E

- ALBUM + **14** (13)
- ALBUM - **16** (13)
- CD **24**
- CLEAR **18** (15)
- CLOCK/TIMER SELECT **2**
(28, 29)
- CLOCK/TIMER SET **4** (11, 27,
28)
- DISC SKIP **13** (12, 13, 15)
- DISPLAY **26** (29, 30)
- ENTER **12** (11, 27, 28, 29, 31,
32)
- EQ **17**

F - Z

- FM MODE **6** (17, 38)
- FUNCTION **8** (12, 15, 17, 20,
34)
- PLAY MODE **5** (13, 15, 37, 39)
- REPEAT **6** (14)
- SLEEP **1** (27)
- TAPE **23**
- TUNER/BAND **7** (16, 17, 20,
29)
- TUNER MEMORY **25** (16)
- TUNING MODE **5** (16, 17)
- VOLUME +/- **15** (27, 31, 36)

SYMBOLS

- I/⏻ (power) **3** (9, 11, 28)
- (stop) **11** (13, 18)
- ⏸ (pause) **19**
- ▶ (play) **20** (18, 19)
- ◀ (go backward) **22** (11, 13,
15, 16, 17, 19, 21, 27, 28, 29)
- ▶▶ (go forward) **21** (11, 13,
15, 16, 17, 19, 21, 27, 28, 29)
- ◀◀ (rewind) **10** (13, 18)
- ▶▶ (fast forward) **9** (13, 18)

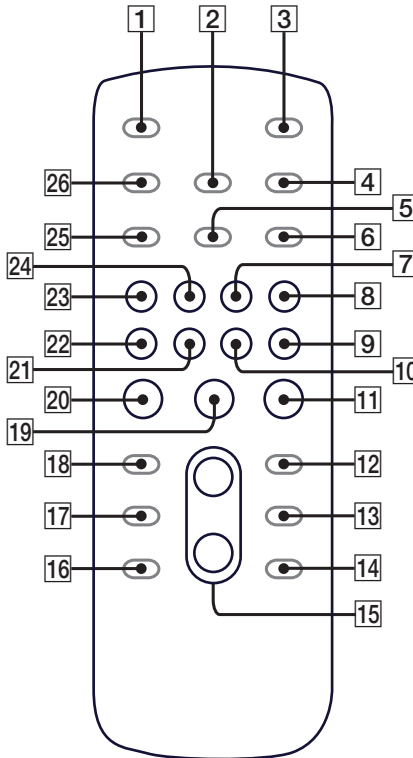



* 4 2 5 3 1 7 2 1 6 * (1)