



For details, refer to the Operating Instructions.

Quick Setup Guide

BDV-E280

©2011 Sony Corporation Printed in Malaysia

1 Connect the speakers

Connect the speaker cords to match the color of the SPEAKERS jacks of the unit.

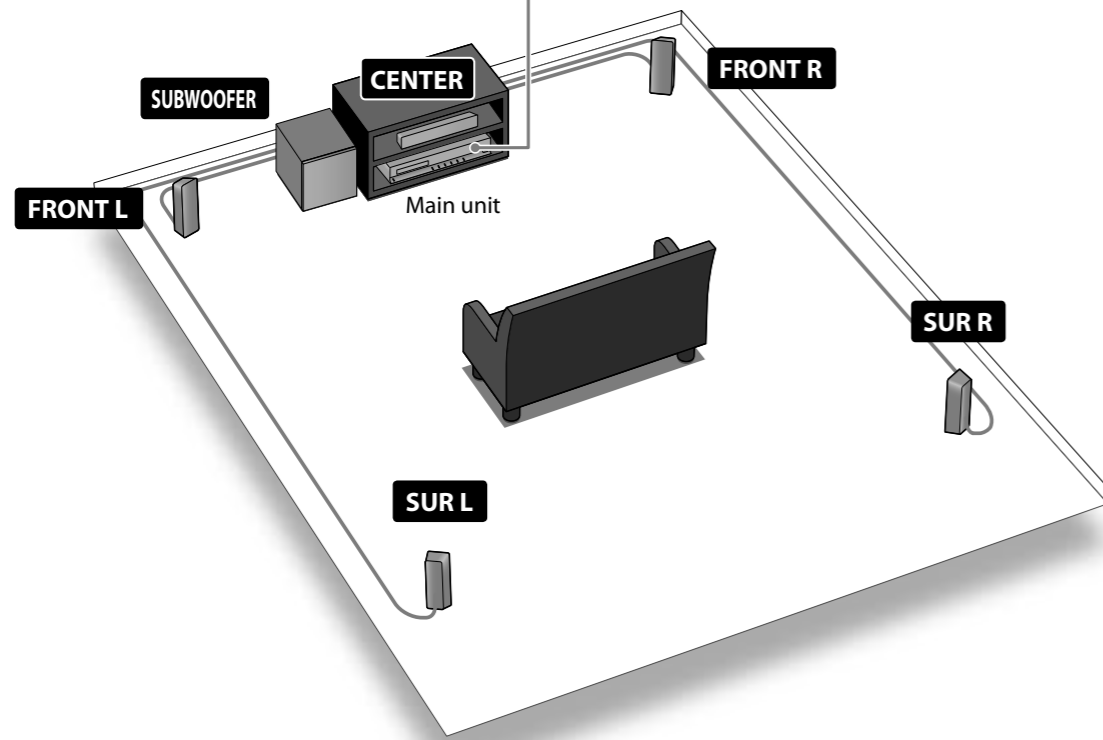
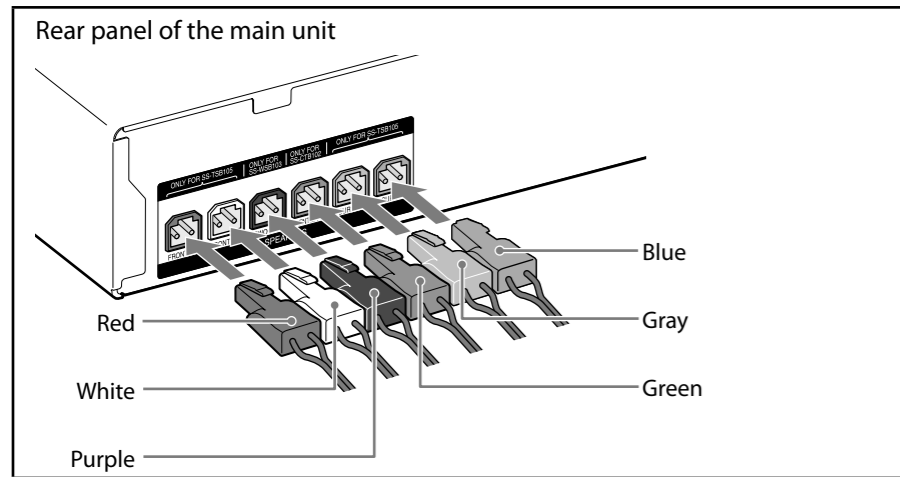

2-A Connect with HDMI cables (recommended)

For connecting with video cords instead of HDMI cables, see "2-B Connect with video cords" on the reverse side.

Connecting your TV

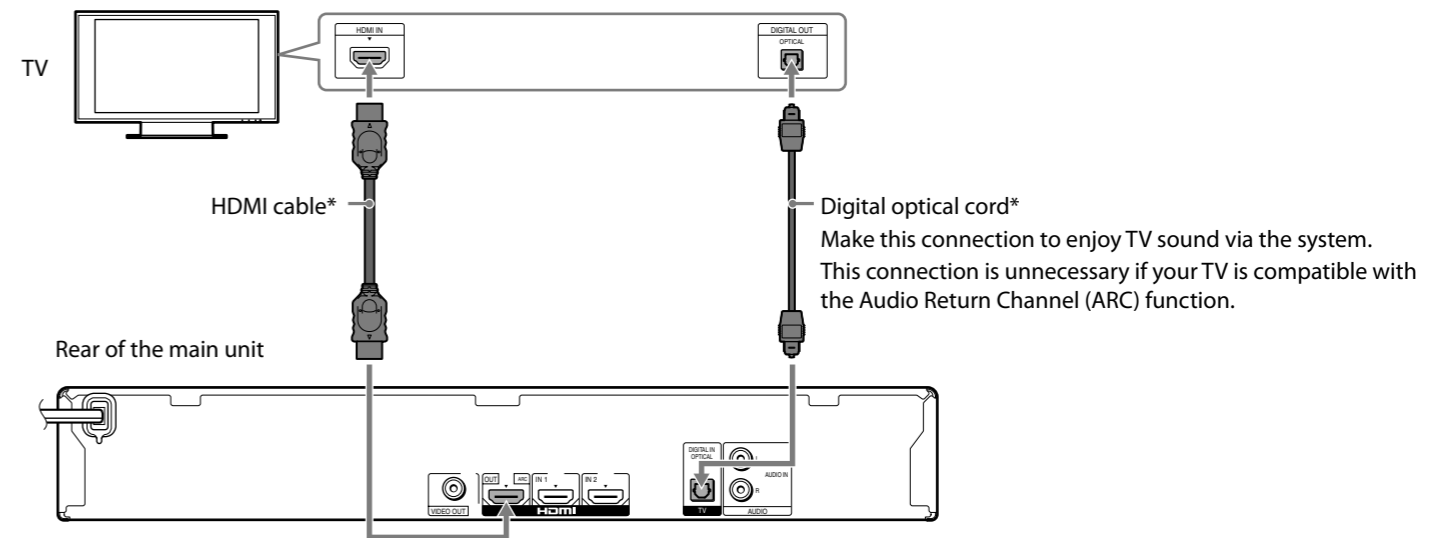

Connecting your set-top box

If you do not use a set-top box, skip to "3 Perform "Easy Setup"" on the reverse side.
To enjoy sound from your set-top box, press FUNCTION repeatedly to select "HDMI 1."

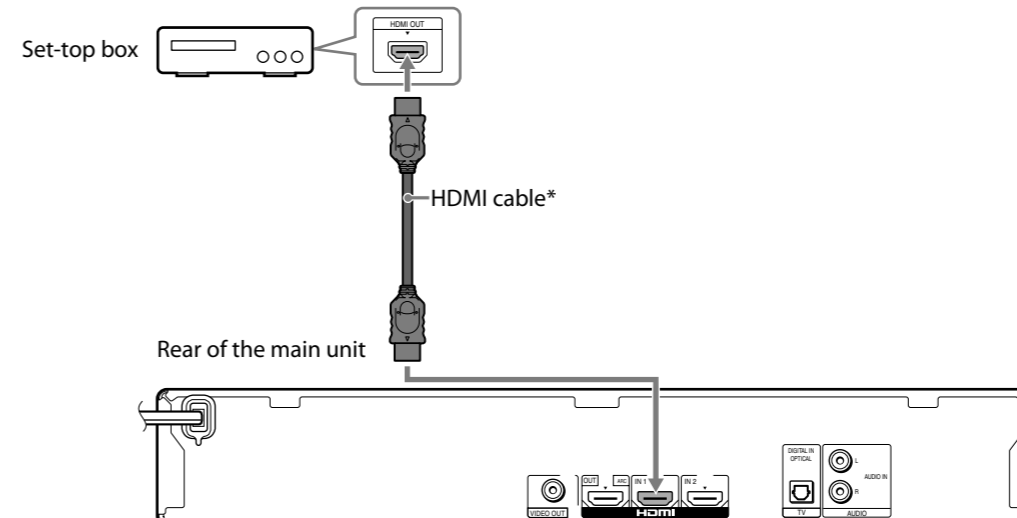

*Not supplied.

2-B Connect with video cords

If you completed "2-A Connect with HDMI cables (recommended)," skip to "3 Perform "Easy Setup.""

Connecting your TV

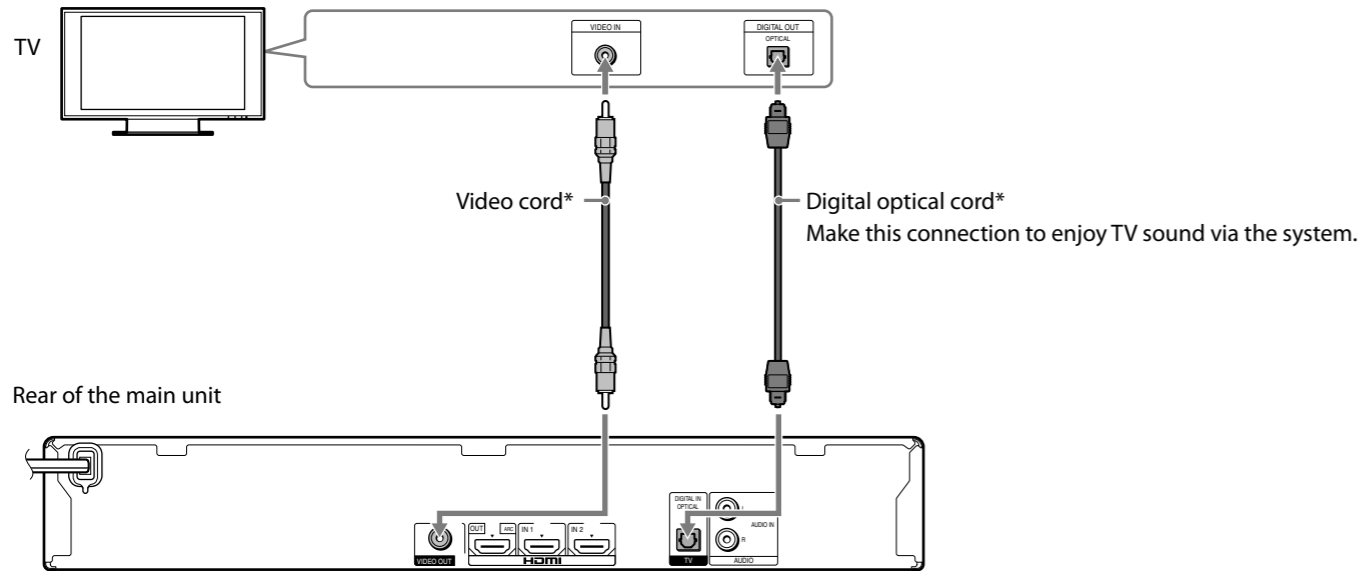

Connecting your set-top box

If you do not use a set-top box, skip to "3 Perform "Easy Setup.""
To enjoy sound from your set-top box, press FUNCTION repeatedly to select "AUDIO."

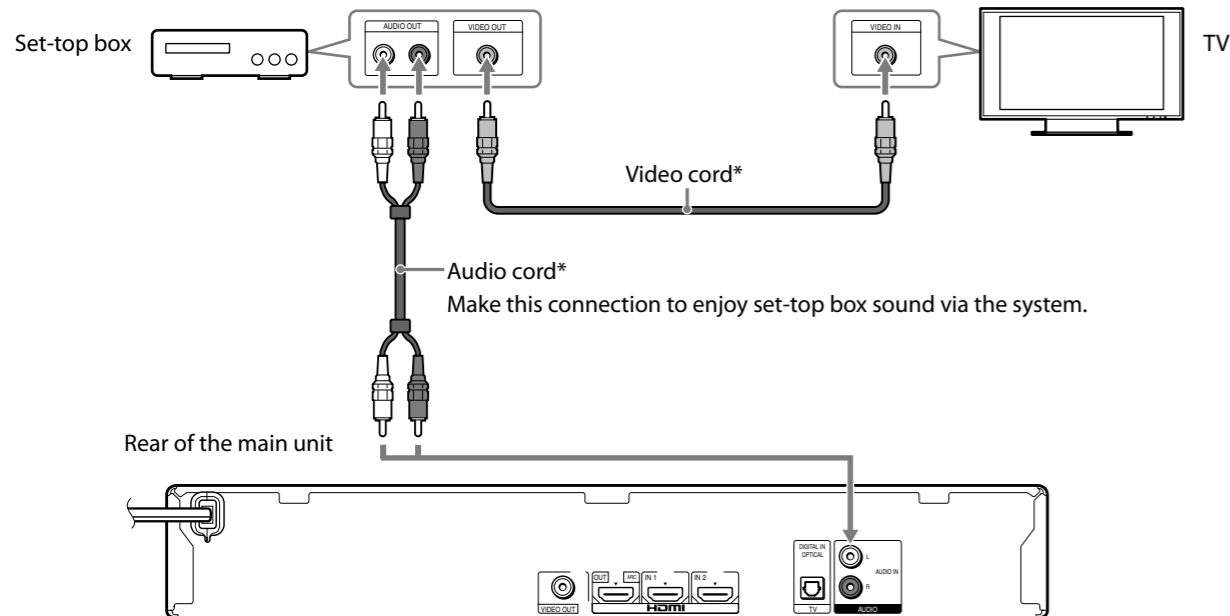

*Not supplied.

3 Perform "Easy Setup"

Do not insert a disc before performing the "Easy Setup".

1. Insert batteries into the remote.

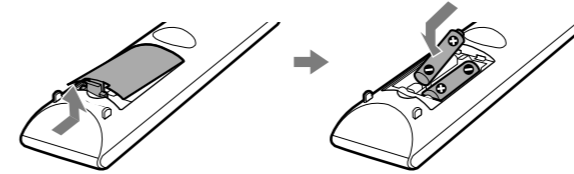

2. Connect the AC power cords of the main unit and your TV to the AC power outlet, and then turn on the power of the main unit and your TV.

3. Switch the input selector on your TV so that system screens like the ones below appear on the TV screen.

Starting up

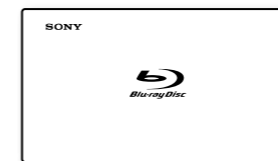

"Easy Setup" screen

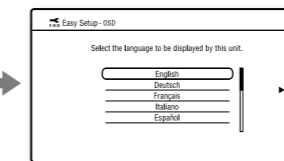

4. Perform basic settings by following the on-screen instructions in "Easy Setup" using ←/↑/↓/→ and +.

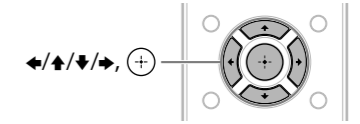

[Easy Setup is now complete.] appears when "Easy Setup" is complete.



Basic setup is complete. Refer to the supplied Operating Instructions for details on how to enjoy disc playback and many other features.