

# CD/DVD Player

Reference Guide

DVP-SR150



# WARNING

To reduce the risk of fire or electric shock, do not expose this apparatus to rain or moisture.

To avoid electrical shock, do not open the cabinet. Refer servicing to qualified personnel only.

The mains lead must be changed only at a qualified service shop.

Batteries or batteries installed apparatus shall not be exposed to excessive heat such as sunshine, fire or the like.

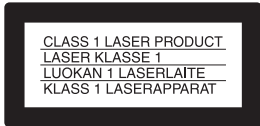

This appliance is classified as a CLASS 1 LASER product. The CLASS 1 LASER PRODUCT MARKING is located on the rear exterior.

## CAUTION

The use of optical instruments with this product will increase eye hazard. As the laser beam used in this CD/DVD player is harmful to eyes, do not attempt to disassemble the cabinet.

Refer servicing to qualified personnel only.

## Notice for customers in the United Kingdom and Republic of Ireland

A moulded plug complying with BS1363 is fitted to this equipment for your safety and convenience. Should the fuse in the plug supplied need to be replaced, a fuse of the same rating as the supplied one and approved by ASTA or BSI to BS1362, (i.e., marked with ⚡ or ⚡ mark) must be used.

If the plug supplied with this equipment has a detachable fuse cover, be sure to attach the fuse cover after you change the fuse. Never use the plug without the fuse cover. If you should lose the fuse cover, please contact your nearest Sony service station.



Disposal of Old Electrical & Electronic Equipment (Applicable in the European Union and other European countries with separate collection systems)

This symbol on the product or on its packaging indicates that this product shall not be treated as household waste. Instead it shall be handed over to the applicable collection point for the recycling of electrical and electronic equipment. By ensuring this product is disposed of correctly, you will help prevent potential negative consequences for the environment and human health, which could otherwise be caused by inappropriate waste handling of this product. The recycling of materials will help to conserve natural resources. For more detailed information about recycling of this product, please contact your local Civic Office, your household waste disposal service or the shop where you purchased the product.



This symbol on the battery or on the packaging indicates that the battery provided with this product shall not be treated as household waste.

On certain batteries this symbol might be used in combination with a chemical symbol. The chemical symbols for mercury (Hg) or lead (Pb) are added if the battery contains more than 0.0005% mercury or 0.004% lead. By ensuring these batteries are disposed of correctly, you will help prevent potentially negative consequences for the environment and human health which could otherwise be caused by inappropriate waste handling of the battery. The recycling of the materials will help to conserve natural resources.

In case of products that for safety, performance or data integrity reasons require a permanent

Disposal of Old Electrical & Electronic Equipment (Applicable in the European Union and other European countries with separate collection systems)

connection with an incorporated battery, this battery should be replaced by qualified service staff only.

To ensure that the battery will be treated properly, hand over the product at end-of-life to the applicable collection point for the recycling of electrical and electronic equipment.

For all other batteries, please view the section on how to remove the battery from the product safely. Hand the battery over to the applicable collection point for the recycling of waste batteries.

For more detailed information about recycling of this product or battery, please contact your local Civic Office, your household waste disposal service or the shop where you purchased the product.

The manufacturer of this product is Sony Corporation, 1-7-1 Konan Minato-ku Tokyo, 108-0075 Japan. The Authorized Representative for EMC and product safety is Sony Deutschland GmbH, Hedelfinger Strasse 61, 70327 Stuttgart, Germany. For any service or guarantee matters please refer to the addresses given in separate service or guarantee documents.

## Precautions

- To prevent fire or shock hazard, do not place objects filled with liquids, such as vases, on the apparatus.
- The player is not disconnected from the AC power source (mains) as long as it is connected to the wall outlet, even if the player itself has been turned off.
- Do not install this player in a confined space, such as a bookshelf or similar unit.
- Install the player so that the AC power cord (mains lead) can be unplugged from the wall socket immediately in the event of trouble.
- If the player is brought directly from a cold to a warm location, or is placed in a very damp room, moisture may condense on the lenses inside the player. Should this occur, the player may not operate properly. In this case, remove the disc and leave the player turned on for about half an hour until the moisture evaporates.

## Note about the discs

Do not use the following discs:

- A disc that has a non-standard shape (e.g., card, heart).
- A disc with a label or sticker on it.

## Region code

Your player has a region code printed on the back of the unit and only will play commercial DVDs (playback only) labelled with identical region codes. This system is used to protect copyrights.

Commercial DVDs labelled  will also play on this player.

Depending on the commercial DVD, there may be no region code indication, even though playing the commercial DVD is prohibited by area restrictions.



Region code

## Copyrights

- Manufactured under license from Dolby Laboratories. Dolby and the double-D symbol are trademarks of Dolby Laboratories.
- “DVD+RW,” “DVD-RW,” “DVD+R,” “DVD+R DL,” “DVD-R,” “DVD VIDEO,” and “CD” logos are trademarks.
- MPEG Layer-3 audio coding technology and patents licensed from Fraunhofer IIS and Thomson.
- All other trademarks are trademarks of their respective owners.
- THIS PRODUCT IS LICENSED UNDER THE MPEG-4 VISUAL PATENT PORTFOLIO LICENSE FOR THE PERSONAL AND NONCOMMERCIAL USE OF A CONSUMER FOR DECODING VIDEO IN COMPLIANCE WITH THE MPEG-4 VISUAL STANDARD (“MPEG-4 VIDEO”) THAT WAS ENCODED BY A CONSUMER ENGAGED IN A PERSONAL AND NONCOMMERCIAL ACTIVITY AND/OR WAS OBTAINED FROM A VIDEO PROVIDER LICENSED BY MPEG LA TO PROVIDE MPEG-4 VIDEO. NO LICENSE IS GRANTED OR SHALL BE IMPLIED FOR ANY OTHER

USE. ADDITIONAL INFORMATION INCLUDING THAT RELATING TO PROMOTIONAL, INTERNAL AND COMMERCIAL USES AND LICENSING MAY BE OBTAINED FROM MPEG LA, LLC. SEE [HTTP://WWW.MPEGLA.COM](http://www.mpegla.com)

## About this manual

“DVD” may be used as a general term for commercial DVDs, DVD+RWs/DVD+Rs/DVD+R DLs (+VR mode) and DVD-RWs/DVD-Rs/DVD-R DLs (VR mode, video mode).

# Playback

## Control Menu display

Use the Control Menu to select a function and to view related information.

### Press DISPLAY.

To change the Control Menu display, press DISPLAY again.

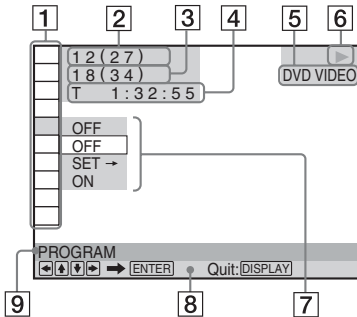

- 1 Control Menu items
- 2 Currently playing title/Total number of titles
- 3 Currently playing chapter/Total number of chapters
- 4 Playing time
- 5 Selected disc type
- 6 Playback status
- 7 Selected item icon/menu options
- 8 Operation message
- 9 Selected Control Menu item

## Menu list

Item	Item Name, Function
	TITLE/SCENE/TRACK
	CHAPTER/INDEX
	TRACK

Selects the title, scene, track, chapter, or index to be played.

## TIME/TEXT

Checks the elapsed time and the remaining playback time.

Input the time code for picture and music search (DVD and Xvid video files only).

## TOP MENU/MENU

(DVD VIDEO only)

**TOP MENU:** Displays the top menu.

**MENU:** Displays the menu.

## ORIGINAL/PLAY LIST

Selects the type of title (DVD-VR mode) to be played: ORIGINAL, or edited PLAY LIST.

## PROGRAM\*1, \*2

Selects the title, chapter, or track to play in the order you want.

- 1 Select "SET →," then press ENTER and select the title (T), chapter (C), or track (T) you want to programme, and press ENTER.
- 2 Repeat selecting the title, chapter, or track.
- 3 Press .

## SHUFFLE\*1, \*2

Plays the title, chapter, or track in random order.

## REPEAT\*1, \*2

Plays all titles/tracks/albums or a single title/chapter/track/album/file repeatedly.

## A-B REPEAT\*1, \*2

Specifies the parts you want to play repeatedly.

- 1 During playback, select "SET →," then press ENTER.  
The "A-B REPEAT" setting bar appears.
- 2 When you find the starting point (point A), press ENTER.
- 3 When you reach the ending point (point B), press ENTER again.

## PARENTAL CONTROL

Set to prohibit playback on this player.

**PLAYER →:** Playback of some DVD VIDEOS can be limited according to a predetermined level such as the age of the users. Scenes may be blocked or replaced with different scenes (Parental Control).

**PASSWORD →:** Enter a 4-digit password using the number buttons. Also use this menu to change the password.

## Parental Control (limited playback)

You can set a playback limitation level.

- 1 Select "PLAYER →," then press ENTER.  
Enter or re-enter your 4-digit password, then press ENTER.
- 2 Press **↑/↓** to select "STANDARD," then press ENTER.  
Press **↑/↓** to select an area, then press ENTER.  
When you select "OTHERS →," select and enter a standard code. See "PARENTAL CONTROL AREA CODE LIST" at the end of this manual.
- 3 Press **↑/↓** to select "LEVEL," then press ENTER.  
Press **↑/↓** to select the level, then press ENTER.  
Parental Control setting is complete.  
The lower the value, the stricter the limitation.  
To turn off the Parental Control function, set "LEVEL" to "OFF."

If you forget your password, enter "199703" in the password box, press ENTER, and then enter a new 4-digit password.

## SETUP

**QUICK:** Use Quick Setup to choose the desired language of the on-screen display, the aspect ratio of the TV and the audio output signal.

**CUSTOM:** In addition to the Quick Setup setting, you can adjust various other settings (page 7).

**RESET:** Returns the settings in "SETUP" to the default setting.

## ZOOM\*<sup>1</sup>

Magnifies the image up to four times the original size, scroll using **←/↑/↓/→**.

## ANGLE

Changes the angle.

## CUSTOM PICTURE MODE

Selects the picture quality that best suits the programme you are watching.

**STANDARD:** Displays a standard picture.

**DYNAMIC:** Produces a bold dynamic picture by increasing the picture contrast and the colour intensity.

**CINEMA:** Enhances details in dark areas by increasing the black level.

**MEMORY →:** Adjusts the picture in greater detail.

## SHARPNESS

Exaggerates the outline of the image to produce a sharper picture.

**OFF:** Cancels this option.

**1:** Enhances the outline.

**2:** Enhances the outline more than 1.

\*1 To return to normal play, select "OFF" or press CLEAR.

\*2 The play mode is cancelled when:

- you open the disc tray.
- you turn off the player.

## ◆Items for DATA discs

Item	Item Name, Function
------	---------------------

	<b>ALBUM</b>
---	--------------

Selects the album that contains music and photo files to be played.

	<b>FILE</b>
---	-------------

Selects the photo file to be played.

	<b>ALBUM</b>
---	--------------

Selects the album that contains the video file to be played.

	<b>FILE</b>
---	-------------

Selects the video file to be played.

	<b>DATE</b>
---	-------------

Displays the date the picture was taken by a digital camera.

	<b>INTERVAL*</b>
---	------------------

Specifies the duration for which the slides are displayed on the screen.

	<b>EFFECT*</b>
---	----------------

Selects the effects to be used for changing slides during a slide show.

**MODE 1:** The images randomly cycle through the effects.

**MODE 2:** The image sweeps in from top left to bottom right.

**MODE 3:** The image sweeps in from top to bottom.

**MODE 4:** The image sweeps in from left to right.

**MODE 5:** The image stretches out from the centre of the screen.

**OFF:** Turns off this function.



## MEDIA

Selects the media type you want to play.

**VIDEO:** Plays video files.

**PHOTO (MUSIC):** Plays photo and music files as a slide show. You can view a slide show with sound when music and photo files are placed in the same album. If the playing time of either music or photos is longer, the longer one continues without sound or image.

**PHOTO:** Plays photo files.

**MUSIC:** Plays music files. Press **SUBTITLE** while playing music files that contain unsynchronized lyric information. The player supports MP3 ID3 Lyrics only.

\* Depending on the file, this function may not be possible.

## To play VIDEO CDs with PBC functions

When you start playing a VIDEO CD with PBC (Playback control) functions, the menu for your selection appears.

### To play without using PBC

Press **◀◀/▶▶** or the number buttons while the player is stopped to select a track, then press **▶** or **ENTER**. To return to PBC playback, press **■** twice, then press **▶**.

## To lock the disc tray (Child Lock)

You can lock the disc tray to prevent it being opened by mistake.

When the player is in standby mode, press in order, **↶** RETURN, **ENTER**, and **I/⏻** on the remote.

The player turns on and “**LOCKED**” appears on the front panel display. The **▲** button does not work while the Child Lock is set.

### To unlock the disc tray

When the player is in standby mode, press in order, **↶** RETURN, **ENTER**, and **I/⏻** on the remote again.

## Controlling TVs with the remote

You can control the sound level, input source, and power switch of your Sony TV with the supplied remote.

If your TV is listed in the table below, set the appropriate manufacturer's code.

When you replace the batteries of the remote, set the appropriate code number again.

- 1 While holding down TV **I/⏻**, press the number buttons to select your TV's manufacturer's code.
- 2 Release TV **I/⏻**.

### Code numbers of controllable TVs

Sony	01 (default)
Hitachi	24
JVC	33
LG/Goldstar	76
Panasonic	17, 49
Philips	06, 08, 72
Samsung	71
Sharp	29
Toshiba	38

# CUSTOM Menu

You can adjust various settings. Press DISPLAY when the player is in stop mode, select  (SETUP), and then select "CUSTOM." The CUSTOM menu appears.

## Menu list

Item	Item Name, Function
	<b>LANGUAGE SETUP</b>
	<b>OSD (On-Screen Display):</b> Switches the display language on the screen.
	<b>MENU*<sup>1</sup>:</b> Selects the desired language for the disc's menu. (DVD VIDEO only)
	<b>AUDIO*<sup>1</sup>:</b> Switches the language of the sound track. When you select "ORIGINAL," the language given priority in the disc is selected. (DVD VIDEO only)
	<b>SUBTITLE*<sup>1</sup>:</b> Switches the language of the subtitle recorded on the DVD VIDEO. When you select "AUDIO FOLLOW," the language for the subtitles changes according to the language you selected for the sound track. (DVD VIDEO only)

## SCREEN SETUP

**TV TYPE:** Selects the aspect ratio of the connected TV.

16:9 

4:3 LETTER BOX 

4:3 PAN SCAN 

**SCREEN SAVER:** When set to "ON," the screen saver appears when the player is in pause or stop mode for 15 minutes. Press  to turn off the screen saver.

**BACKGROUND:** Selects the background colour or picture on the TV screen. If you set "JACKET PICTURE," even though the disc does not contain a jacket picture, the "GRAPHICS" picture appears.

**LINE:** Selects video signals output.

## CUSTOM SETUP

**AUTO STANDBY:** Sets the Auto Standby setting on or off. If you select "ON," the player enters standby mode when left in stop mode for more than 30 minutes.

**AUTO PLAY:** When set to "ON," the player automatically starts playback when the player is turned on by a timer (not supplied).

**PAUSE MODE:** Selects the picture in pause mode. Normally select "AUTO." When the picture is output in high resolution, set to "FRAME." (DVD only)

**TRACK SELECTION:** Gives the sound track which contains the highest number of channels priority when you play a DVD VIDEO on which multiple audio formats (PCM, MPEG audio, DTS, or Dolby Digital format) are recorded. If you select "AUTO," priority is given. (DVD VIDEO only)

**MULTI-DISC RESUME:** Switches the Multi-disc Resume setting on or off. Resume playback can be stored in memory for up to 6 different DVD VIDEOS/VIDEO CDs. If you start the settings again, the resume point is cleared. (DVD VIDEO/VIDEO CD only)

## AUDIO SETUP

**AUDIO DRC (Dynamic Range Control)\*<sup>2</sup>:** Set according to the surrounding environment. Set to "TV MODE" when the smallest sounds are indiscernible, or set to "WIDE RANGE" when the listening environment is good, for example, in a home movie theatre.

**DOWNMIX\*<sup>2</sup>:** Switches the method for mixing down to 2 channels when you play a DVD which has rear sound elements (channels), or is recorded in Dolby Digital format. Normally select "DOLBY SURROUND."

**DIGITAL OUT:** Selects if audio signals are output via the DIGITAL OUT (COAXIAL) jack. When you select "ON," set also the following "DOLBY DIGITAL," "MPEG," "DTS," or "48kHz/96kHz PCM."

**DOLBY DIGITAL:** Selects the type of Dolby Digital signal. Set to "D-PCM" when the player is connected to an audio component without a built-in Dolby Digital decoder.

**MPEG:** Selects the type of MPEG audio signal. Set to "MPEG" when the player is connected to an audio component with a built-in MPEG decoder.

**DTS:** Selects the type of DTS audio signal. Set to "ON" when you play a DVD VIDEO with DTS sound tracks. Do not set to "ON" when you connect the player to an audio component without a DTS decoder.

**48kHz/96kHz PCM:** Selects the sampling frequency of the digital audio output signal. (DVD VIDEO only)

---

- \*1 When you select "OTHERS →," select and enter a language code. See "LANGUAGE CODE LIST" at the end of this manual.
- \*2 This function affects the output from the following jacks:
  - AUDIO OUT L/R jacks.
  - DIGITAL OUT (COAXIAL) jack only when "DOLBY DIGITAL" is set to "D-PCM."
  - LINE (RGB)-TV jack.

---

## Information

---

### Troubleshooting

If you experience any of the following difficulties while using the player, use this troubleshooting guide to help remedy the problem before requesting repairs. Should any problem persist, consult your nearest Sony dealer.

---

#### **The power is not turned on.**

- Check that the power cord (mains lead) is connected securely.
- 

#### **There is no picture/picture noise appears.**

- Re-connect the connecting cord securely.
  - The connecting cords are damaged.
  - Check the connection to your TV and switch the input selector on your TV so that the signal from the player appears on the TV screen.
  - Set "LINE" in "SCREEN SETUP" to an item appropriate for your TV.
  - The disc is dirty or flawed.
- 

#### **There is no sound.**

- Re-connect the connecting cord securely.
  - The connecting cord is damaged.
  - The player is in pause mode or in Slow-motion Play mode.
  - The player is in fast forward or fast reverse mode.
- 

#### **The remote does not function.**

- The batteries in the remote are weak.
  - The remote is not pointed at the remote sensor  on the player.
  - When you operate the player by pressing buttons on the remote in sequence, press the buttons within 5 seconds of each other.
- 

#### **The disc does not play.**

- The disc is turned over.  
Insert the disc with the playback side facing down.
- The disc is skewed.
- The player cannot play certain discs.
- The region code on the DVD does not match the player.
- Moisture has condensed inside the player.
- The player cannot play a recorded disc that is not correctly finalized.



---

**The player does not operate properly.**

→ When static electricity, etc., causes the player to operate abnormally, unplug the player.

---

**The disc tray does not open and “LOCK” (LOCKED) appears on the front panel display.**

→ Child Lock is set (page 6).

---

**The disc tray does not open and “TRAY LOCKED” (TRAY LOCKED) appears on the front panel display.**

→ Contact your Sony dealer or local authorized Sony service facility.

---

**“C13” appears on the front panel display.**

→ Clean the disc with a cleaning cloth or check its format.

---

**“C31” appears on the front panel display.**

→ Re-insert the disc correctly.

---

---

**Playable file format**

Video: MPEG-1 (Cyber-shot data)/MPEG-4 (simple profile)\*<sup>1</sup>/Xvid

Photo: JPEG (DCF format)

Music: MP3 (except for mp3PRO)/WMA (except for WMA Pro)\*<sup>1</sup>, \*<sup>2</sup>/AAC\*<sup>1</sup>, \*<sup>2</sup>/LPCM/WAVE

\*<sup>1</sup> Files with copyright protection (Digital Right Management) cannot be played.

\*<sup>2</sup> The player does not play coded files such as Lossless.

Supported extensions: “.avi”, “.mpg”, “.mpeg”, “.mp4”, “.jpg”, “.mp3”, “.wma”, “.m4a”, “.wav”

Supported discs: DVD, DVD±RW/±R/±R DL, Music CD/Super VCD, CD-R/-RW

- DATA CDs recorded according to ISO 9660 Level 1/Level 2, or its extended format, Joliet.
- DATA DVDs recorded according to UDF.
- The player will play any file in the above, even if the file format differs. Playing such data may generate noise that can result in speaker damage.
- To play a complex hierarchy of folders may take some time. Create albums with no more than two hierarchies.
- Some video, photo, and music files may not play, depending on the encoding/recording condition.

- To start playback and proceed to the next or another album/file may take some time.
- The player will recognize a maximum of 200 albums and 600 files. It can recognize up to 300 music files and 300 photo files when “PHOTO (MUSIC)” is selected.
- The player may not play a combination of two or more video files.
- The player cannot play a video file of size more than 720 (width) × 576 (height)/2 GB.
- Depending on the file, playback may not be smooth. You are recommended to create the file at a lower bit rate.
- The player may not play back the high bit rate video file on the DATA CD smoothly. You are recommended to play back using DATA DVD.
- When playing visual data that is not supported by MPEG-4 format, only sound will be heard.

**Note about recordable media**

Some recordable media cannot be played on this player due to the recording quality or physical condition of the disc, or the characteristics of the recording device and authoring software. The disc will not play if it has not been correctly finalized. Also some DATA discs created in Packet Write format cannot be played.

**For player that cannot play images that contain a copy protection only**

Images in DVD-VR mode with CPRM (Content Protection for Recordable Media) protection may not be played.

**Note on playback operations of DVDs and VIDEO CDs**

Some playback operations of DVDs and VIDEO CDs may be intentionally set by software producers. Since this player plays DVDs and VIDEO CDs according to the disc contents the software producers designed, some playback features may not be available. Also, refer to the operating instructions supplied with the DVDs or VIDEO CDs.

## **Note on discs**

This unit is designed to playback discs that conform to the Compact Disc (CD) standard. DualDiscs and some music discs encoded with copyright protection technologies do not conform to the Compact Disc (CD) standard. Therefore, these discs may not be compatible with this unit.

---

## **Specifications**

### **System**

Laser: Semiconductor laser

### **Outputs**

- AUDIO OUT (L/R): Phono jack
- DIGITAL OUT (COAXIAL): Phono jack
- LINE (RGB)-TV: 21 pin

### **General**

- Power requirements: 220-240 V AC, 50/60 Hz
- Power consumption: 6 W
- Dimensions (approx.): 320 × 38 × 209 mm (width/height/depth) incl. projecting parts
- Mass (approx.): 1.1 kg
- Operating temperature: 5 °C to 35 °C
- Operating humidity: 25 % to 80 %

### **Supplied accessories**

- Remote commander (remote) (1)
- R6 (size AA) batteries (2)

Specifications and design are subject to change without notice.

# LANGUAGE CODE LIST

📄 page 7

Code Language	Code Language	Code Language	Code Language
1027 Afar	1183 Irish	1347 Maori	1507 Samoan
1028 Abkhazian	1186 Scots Gaelic	1349 Macedonian	1508 Shona
1032 Afrikaans	1194 Galician	1350 Malayalam	1509 Somali
1039 Amharic	1196 Guarani	1352 Mongolian	1511 Albanian
1044 Arabic	1203 Gujarati	1353 Moldavian	1512 Serbian
1045 Assamese	1209 Hausa	1356 Marathi	1513 Siswati
1051 Aymara	1217 Hindi	1357 Malay	1514 Sesotho
1052 Azerbaijani	1226 Croatian	1358 Maltese	1515 Sundanese
1053 Bashkir	1229 Hungarian	1363 Burmese	1516 Swedish
1057 Byelorussian	1233 Armenian	1365 Nauru	1517 Swahili
1059 Bulgarian	1235 Interlingua	1369 Nepali	1521 Tamil
1060 Bihari	1239 Interlingue	1376 Dutch	1525 Telugu
1061 Bislama	1245 Inupiak	1379 Norwegian	1527 Tajik
1066 Bengali;	1248 Indonesian	1393 Occitan	1528 Thai
Bangla	1253 Icelandic	1403 (Afan)Oromo	1529 Tigrinya
1067 Tibetan	1254 Italian	1408 Oriya	1531 Turkmen
1070 Breton	1257 Hebrew	1417 Punjabi	1532 Tagalog
1079 Catalan	1261 Japanese	1428 Polish	1534 Setswana
1093 Corsican	1269 Yiddish	1435 Pashto;	1535 Tonga
1097 Czech	1283 Javanese	Pushto	1538 Turkish
1103 Welsh	1287 Georgian	1436 Portuguese	1539 Tsonga
1105 Danish	1297 Kazakh	1463 Quechua	1540 Tatar
1109 German	1298 Greenlandic	1481 Rhaeto-	1543 Twi
1130 Bhutani	1299 Cambodian	Romance	1557 Ukrainian
1142 Greek	1300 Kannada	1482 Kirundi	1564 Urdu
1144 English	1301 Korean	1483 Romanian	1572 Uzbek
1145 Esperanto	1305 Kashmiri	1489 Russian	1581 Vietnamese
1149 Spanish	1307 Kurdish	1491 Kinyarwanda	1587 Volapük
1150 Estonian	1311 Kirghiz	1495 Sanskrit	1613 Wolof
1151 Basque	1313 Latin	1498 Sindhi	1632 Xhosa
1157 Persian	1326 Lingala	1501 Sangho	1665 Yoruba
1165 Finnish	1327 Laothian	1502 Serbo-	1684 Chinese
1166 Fiji	1332 Lithuanian	Croatian	1697 Zulu
1171 Faroese	1334 Latvian;	1503 Singhalese	
1174 French	Lettish	1505 Slovak	
1181 Frisian	1345 Malagasy	1506 Slovenian	1703 Not specified

ISO 639: 1988 (E/F) standard

# PARENTAL CONTROL AREA CODE LIST

📄 page 4

Code Area	Code Area	Code Area	Code Area
2044 Argentina	2165 Finland	2362 Mexico	2149 Spain
2047 Australia	2174 France	2376 Netherlands	2499 Sweden
2046 Austria	2109 Germany	2390 New Zealand	2086 Switzerland
2057 Belgium	2248 India	2379 Norway	2528 Thailand
2070 Brazil	2238 Indonesia	2427 Pakistan	2184 United Kingdom
2079 Canada	2254 Italy	2424 Philippines	
2090 Chile	2276 Japan	2436 Portugal	
2092 China	2304 Korea	2489 Russia	
2115 Denmark	2363 Malaysia	2501 Singapore	

💡 To find out useful hints, tips and information about Sony products and services please visit:  
[www.sony-europe.com/myproduct/](http://www.sony-europe.com/myproduct/)



4-266-022-11(1)