

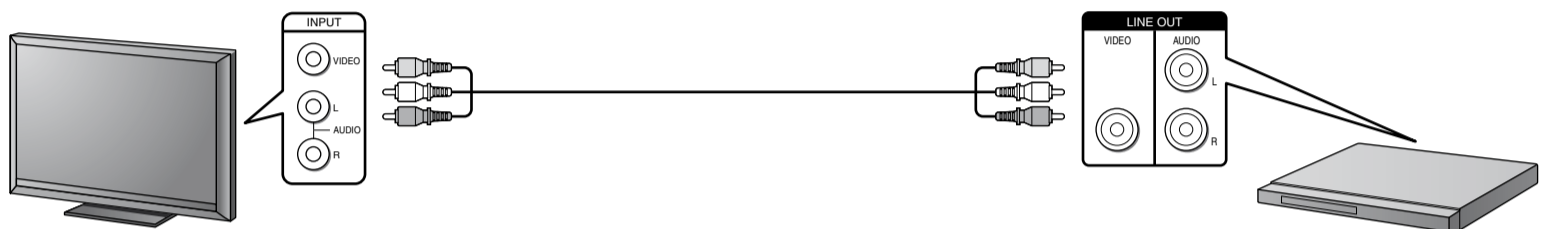

CD/DVD Player

Startup Guide / Guide de démarrage / Panduan Persiapan / คู่มือสำหรับเริ่มต้นใช้งาน / دليل بدء التشغيل / راهنمای شروع / 시작 안내서 / 入門指南 / 入门指南

1



2

1

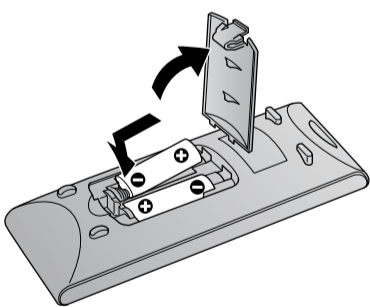

2

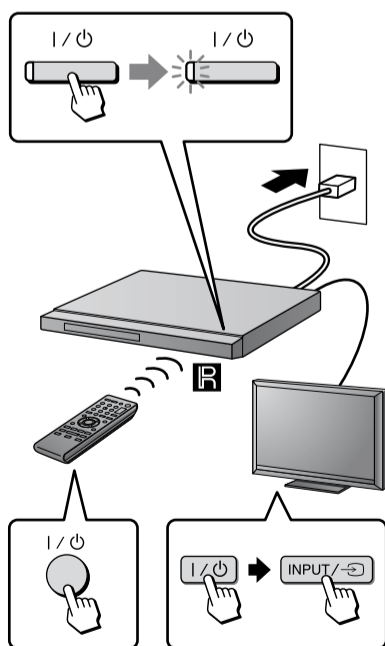

3 NTSC ↔ PAL

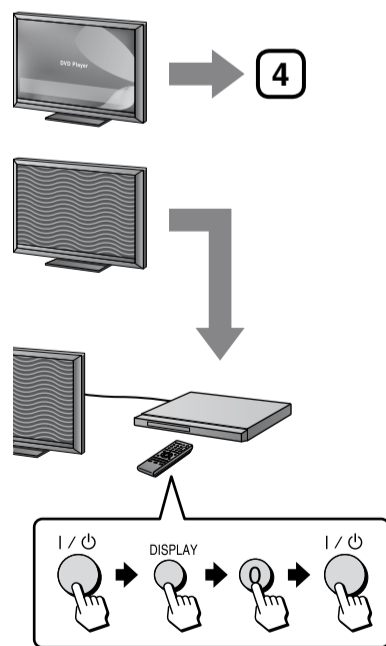

4

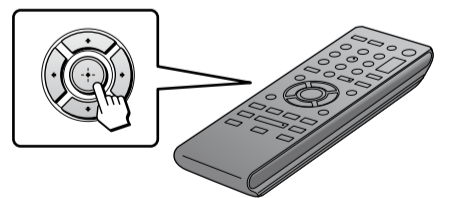
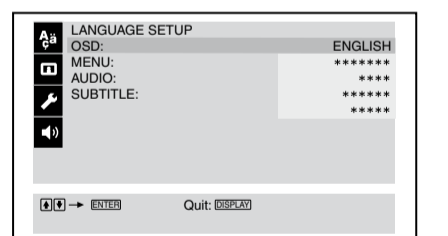

I/O :
 on/standby 컴/대기
 marche/veille 開 / 待機
 nyala/siaga 开 / 待机
 เปิด/เตรียมพร้อม
 تشغيل/الانتظار
 روشن/آماده باش

3

1

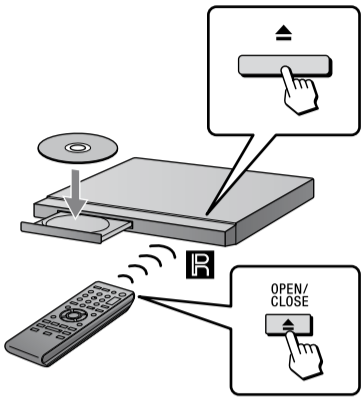

2

