

# SONY®

## Home Audio System

### Operating Instructions

---

Getting Started

---

Disc

---

Tuner

---

USB Device

---

BLUETOOTH

---

Sound Adjustment

---

Other Operations

---

Additional Information

## WARNING

**To reduce the risk of fire or electric shock, do not expose this apparatus to rain or moisture.**

To reduce the risk of fire, do not cover the ventilation opening of the appliance with newspapers, tablecloths, curtains, etc. Do not expose the appliance to naked flame sources (for example, lighted candles).

To reduce the risk of fire or electric shock, do not expose this appliance to dripping or splashing, and do not place objects filled with liquids, such as vases, on the appliance.

As the main plug is used to disconnect the unit from the mains, connect the unit to an easily accessible AC outlet. Should you notice an abnormality in the unit, disconnect the main plug from the AC outlet immediately.

Do not install the appliance in a confined space, such as a bookcase or built-in cabinet.

Do not expose batteries or appliances with battery-installed to excessive heat, such as sunshine and fire.

The unit is not disconnected from the mains as long as it is connected to the AC outlet, even if the unit itself has been turned off.

Indoor use only.

## CAUTION

The use of optical instruments with this product will increase eye hazard.

## Notice for the customers in the USA

### Owner's Record

The model and serial numbers are located on the rear of the unit. Record these numbers in the space provided below. Refer to them whenever you call upon your Sony dealer regarding this product.

Model No. \_\_\_\_\_

Serial No. \_\_\_\_\_

## Important Safety Instructions

- 1) Read these instructions.
- 2) Keep these instructions.
- 3) Heed all warnings.
- 4) Follow all instructions.
- 5) Do not use this apparatus near water.
- 6) Clean only with dry cloth.
- 7) Do not block any ventilation openings. Install in accordance with the manufacturer's instructions.
- 8) Do not install near any heat sources such as radiators, heat registers, stoves, or other apparatus (including amplifiers) that produce heat.
- 9) Do not defeat the safety purpose of the polarized or grounding-type plug. A polarized plug has two blades with one wider than the other. A grounding type plug has two blades and a third grounding prong. The wide blade or the third prong are provided for your safety. If the provided plug does not fit into your outlet, consult an electrician for replacement of the obsolete outlet.
- 10) Protect the power cord from being walked on or pinched particularly at plugs, convenience receptacles, and the point where they exit from the apparatus.
- 11) Only use attachments/accessories specified by the manufacturer.
- 12) Use only with the cart, stand, tripod, bracket, or table specified by the manufacturer, or sold with the apparatus. 

When a cart is used, use caution when moving the cart/apparatus combination to avoid injury from tip-over.
- 13) Unplug this apparatus during lightning storms or when unused for long periods of time.
- 14) Refer all servicing to qualified service personnel. Servicing is required when the apparatus has been damaged in any way, such as power-supply cord or plug is damaged, liquid has been spilled or objects have fallen into the apparatus, the apparatus has been exposed to rain or moisture, does not operate normally, or has been dropped.



This symbol is intended to alert the user to the presence of uninsulated “dangerous voltage” within the product’s enclosure that may be of sufficient magnitude to constitute a risk of electric shock to persons.



This symbol is intended to alert the user to the presence of important operating and maintenance (servicing) instructions in the literature accompanying the appliance.

**The following FCC statement applies only to the version of this model manufactured for sale in the USA. Other versions may not comply with FCC technical regulations.**

**NOTE:**

This equipment has been tested and found to comply with the limits for a Class B digital device, pursuant to Part 15 of the FCC Rules. These limits are designed to provide reasonable protection against harmful interference in a residential installation. This equipment generates, uses and can radiate radio frequency energy and, if not installed and used in accordance with the instructions, may cause harmful interference to radio communications. However, there is no guarantee that interference will not occur in a particular installation. If this equipment does cause harmful interference to radio or television reception, which can be determined by turning the equipment off and on, the user is encouraged to try to correct the interference by one or more of the following measures:

- Reorient or relocate the receiving antenna.
- Increase the separation between the equipment and receiver.
- Connect the equipment into an outlet on a circuit different from that to which the receiver is connected.
- Consult the dealer or an experienced radio/TV technician for help.

**CAUTION**

You are cautioned that any changes or modifications not expressly approved in this manual could void your authority to operate this equipment.

This equipment must not be co-located or operated in conjunction with any other antenna or transmitter.

This equipment complies with FCC radiation exposure limits set forth for an uncontrolled environment and meets the FCC radio frequency (RF) Exposure Guidelines. This equipment has very low levels of RF energy that is deemed to comply without maximum permissive exposure evaluation (MPE). But it is desirable that it should be installed and operated keeping the radiator at least 20 cm or more away from person’s body (excluding extremities: hands, wrists, feet and ankles).

## For customers in Europe



This appliance is classified as a CLASS 1 LASER product. This marking is located on the rear exterior.

### Disposal of waste batteries and electrical and electronic equipment (applicable in the European Union and other European countries with separate collection systems)



This symbol on the product, the battery or on the packaging indicates that the product and the battery shall not be treated as household waste. On certain batteries

this symbol might be used in combination with a chemical symbol. The chemical symbols for mercury (Hg) or lead (Pb) are added if the battery contains more than 0.0005% mercury or 0.004% lead. By ensuring these products and batteries are disposed of correctly, you will help prevent potentially negative consequences for the environment and human health which could otherwise be caused by inappropriate waste handling. The recycling of the materials will help to conserve natural resources.

In case of products that for safety, performance or data integrity reasons require a permanent connection with an incorporated battery, this battery should be replaced by qualified service staff only. To ensure that the battery and the electrical and electronic equipment will be treated properly, hand over these products at end-of-life to the applicable collection point for the recycling of electrical and electronic equipment. For all other batteries, please view the section on how to remove the battery from the product safely. Hand the battery over to the applicable collection point for the recycling of waste batteries. For more detailed information about recycling of this product or battery, please contact your local Civic Office, your household waste disposal service or the shop where you purchased the product or battery.

### Notice for customers: the following information is only applicable to equipment sold in countries applying EU directives.

This product has been manufactured by or on behalf of Sony Corporation, 1-7-1 Konan Minato-ku Tokyo, 108-0075 Japan. Inquiries related to product compliance based on European Union legislation shall be addressed to the authorized representative, Sony Belgium, bijkantoor van Sony Europe Limited, Da Vincilaan 7-D1, 1935 Zaventem, Belgium. For any service or guarantee matters, please refer to the addresses provided in the separate service or guarantee documents.

Hereby, Sony Corporation declares that this equipment is in compliance with Directive 2014/53/EU.

The full text of the EU declaration of conformity is available at the following internet address:

<http://www.compliance.sony.de/>



The validity of the CE marking is restricted to only those countries where it is legally enforced, mainly in the countries EEA (European Economic Area).

This equipment has been tested and found to comply with the limits set out in the EMC Directive using a connection cable shorter than 3 meters.

## For customers in Australia and India



**Disposal of Old Electrical & Electronic Equipment (Applicable in the European Union and other European countries with separate collection systems)**

### **Note on DualDiscs**

A DualDisc is a two sided disc product which mates DVD recorded material on one side with digital audio material on the other side. However, since the audio material side does not conform to the Compact Disc (CD) standard, playback on this product is not guaranteed.

### **Music discs encoded with copyright protection technologies**

This product is designed to play back discs that conform to the Compact Disc (CD) standard. Recently, various music discs encoded with copyright protection technologies are marketed by some record companies. Please be aware that among those discs, there are some that do not conform to the CD standard and may not be playable by this product.

This system is designed to be used for the following purposes:

- Playing back music sources on discs or USB devices
- Transferring music to USB devices
- Listening to radio stations
- Playing back music sources on BLUETOOTH devices
- Enjoying social gatherings with the "Party Chain" function

---

## **About this manual**

- This manual mainly explains operations using the remote control, but the same operations can also be performed using the buttons on the unit having the same or similar names.
- Some illustrations are presented as conceptual drawings, and may be different from the actual products.

---

## Table of Contents

|                                   |   |
|-----------------------------------|---|
| About this manual.....            | 5 |
| Guide to parts and controls ..... | 8 |

---

### Getting Started

|   |    |
|---|----|
| Hooking up the system<br>securely.....  | 12 |
| Deactivating the<br>demonstration ..... | 13 |
| Inserting batteries .....               | 13 |
| Carrying the system .....               | 13 |
| Changing the display mode ....          | 14 |
| About the power<br>management .....     | 14 |

---

### Disc

|                             |    |
|-----------------------------|----|
| Playing a CD/MP3 disc ..... | 15 |
|-----------------------------|----|

---

### Tuner

|                              |    |
|------------------------------|----|
| Listening to the radio ..... | 17 |
|------------------------------|----|

---

### USB Device

|  |    |
|--|----|
| Before using the USB device ...        | 18 |
| Transferring music from a<br>disc..... | 18 |
| Playing a file .....                   | 20 |

---

### BLUETOOTH

|  |    |
|--|----|
| About the BLUETOOTH<br>wireless technology.....                | 21 |
| Pairing this system with a<br>BLUETOOTH device.....            | 22 |
| Listening to music on a<br>BLUETOOTH device.....               | 23 |
| One Touch BLUETOOTH<br>Connection by NFC .....                 | 23 |
| Playing back with high quality<br>sound codec (AAC/LDAC™) .... | 24 |
| Turning on or off the<br>BLUETOOTH signal.....                 | 25 |
| Using "Sony   Music Center" via<br>BLUETOOTH .....             | 26 |

---

### Sound Adjustment

|   |    |
|---|----|
| Adjusting the sound.....                        | 26 |
| Creating a party atmosphere<br>(DJ EFFECT)..... | 27 |

---

## Other Operations

|   |    |
|---|----|
| Using the Party Chain<br>function.....                    | 28 |
| Singing along: Karaoke .....                              | 30 |
| Enjoying music with the<br>Speaker Lights turned on ..... | 31 |
| Using an optional<br>equipment .....                      | 31 |
| Changing information on the<br>display.....               | 32 |
| Using the Sleep Timer .....                               | 32 |
| Deactivating the buttons on<br>the unit (Child Lock)..... | 32 |
| Setting the automatic standby<br>function.....            | 32 |

---

## Additional Information

|  |    |
|--|----|
| Information about compatible<br>devices..... | 33 |
| Troubleshooting .....                        | 33 |
| Precautions .....                            | 38 |
| Specifications.....                          | 40 |
| License and Trademark<br>Notice.....         | 42 |

# Guide to parts and controls

You can lock the buttons except ⏻ (power) on the unit to prevent them from being operated by mistake (page 32).

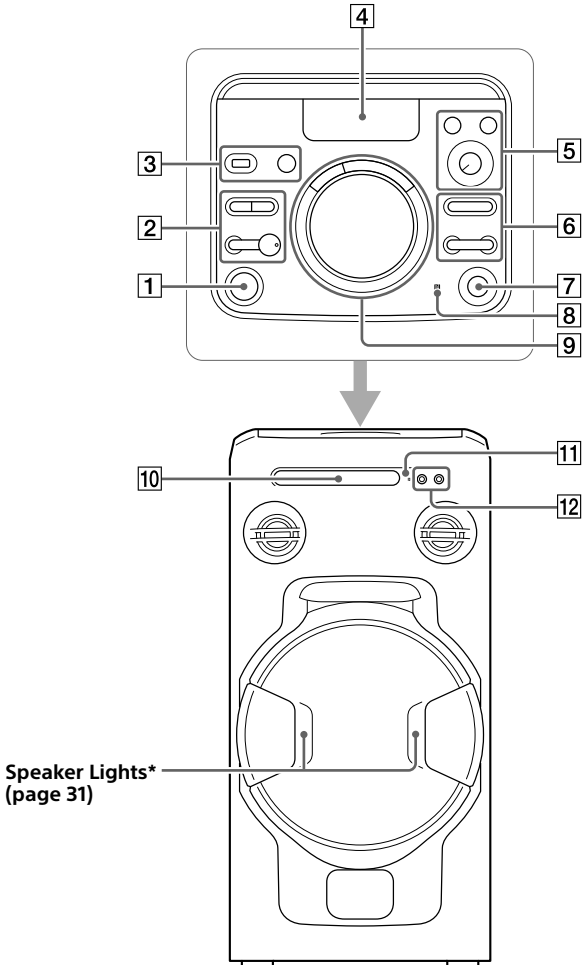

## Unit



\* Do not look directly at the light-emitting parts when the Speaker Lights are turned on.



**1**  (power) button  
Press to turn on the system, or set it to standby mode.

**2**  (play)\* button  
— Press to start playback.  
— When you hold down this button for more than 5 seconds, the built-in sound demonstration will be played back. Press  to stop the demonstration.

** (stop) button**

- Press to stop playback. When pressed twice, resume playback can be canceled.
- Press to stop transfer during music transfer.
- Press to stop the built-in sound demonstration.

**BLUETOOTH – PAIRING button**

- Press to select the BLUETOOTH function.
- Hold down to activate BLUETOOTH pairing in the BLUETOOTH function.

**BLUETOOTH indicator (page 21)**

**FUNCTION button**

Press to select a function.

**3**  (USB) port  
Use to connect a USB device.

**MEGA BASS – PARTY CHAIN button (page 26, 30)**

**4** Display

**5** VOCAL FADER button (page 31)

**MIC ECHO button (page 31)**

**MIC LEVEL (MIN/MAX) knob (page 30)**

**6**  +/- (select folder) button  
Press to select a folder on a data disc or a USB device.

** (go backward/go forward) button**  
Press to select a track or file.

**TUNING+/- button (page 17)**

**7**  (open/close) button  
Press to open or close the disc tray.

**8**  (N-Mark) (page 24)

**9** DJ OFF, FLANGER, ISOLATOR buttons (page 27)

**VOLUME/DJ CONTROL knob**

- Turn to adjust the volume. You cannot use this knob to adjust the volume when DJ EFFECT is selected.
- Turn to adjust the FLANGER and ISOLATOR effect (page 27).

**10** Disc tray

**11** Remote control sensor

**12** MIC 1/2 jack  
Use to connect the microphone(s).

\* The  button on the unit has a tactile dot. Use the tactile dot as a reference when operating the system.

## Remote control

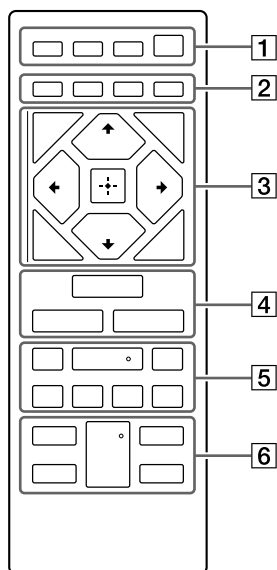

- 1** **SPEAKER LIGHT button**  
(page 31)

### DISPLAY button

Press to change the information on the display.

### SLEEP button (page 32)

### (power) button

Press to turn on the system, or set it to standby mode.

- 2** **PLAY MODE button** (page 15, 20)

### REPEAT/FM MODE button (page 15, 17, 20)

### CLEAR button (page 16, 21)

### REC TO USB button (page 19)

Press to transfer music from a disc to the connected optional USB device.

- 3** **TUNING MODE button**  
(page 17)

### TUNER MEMORY button (page 17)

### BACK button

Press to return to the previous display.

### OPTIONS button

Press to enter or exit options menu.

### buttons

Press to select the menu items.

### +/- (select folder) buttons

Press to select a folder on a data disc or USB device.

### button

Press to enter/confirm the settings.

- 4** **FUNCTION button**  
Press to select a function.

### MEGA BASS button (page 26)

### EQ button (page 26)

- 5** **◀◀/▶▶** (rewind/fast forward) buttons (page 15, 20)  
Press to find a point in a track or file during playback.

**TUNING+/-** buttons (page 17)

**▶** (play)\* button  
Press to start playback.

**◀◀/▶▶** (go backward/go forward) buttons  
Press to select a track or file.

**PRESET+/-** buttons (page 17)

**||** (pause) button  
Press to pause playback. To resume playback, press **▶**.

**■** (stop) button

- Press to stop playback. When pressed twice, resume playback can be canceled.
- Press to stop transfer during music transfer.
- Press to stop the built-in sound demonstration.

- 6** **VOCAL FADER** button (page 31)

**MIC ECHO** button (page 31)

**KEY CONTROL #/b** buttons (page 31)

**VOL +/- \*** button  
Press to adjust the volume.

\* The VOL + and **▶** buttons on the remote control have a tactile dot. Use the tactile dot as a reference when operating the system.

## Hooking up the system securely

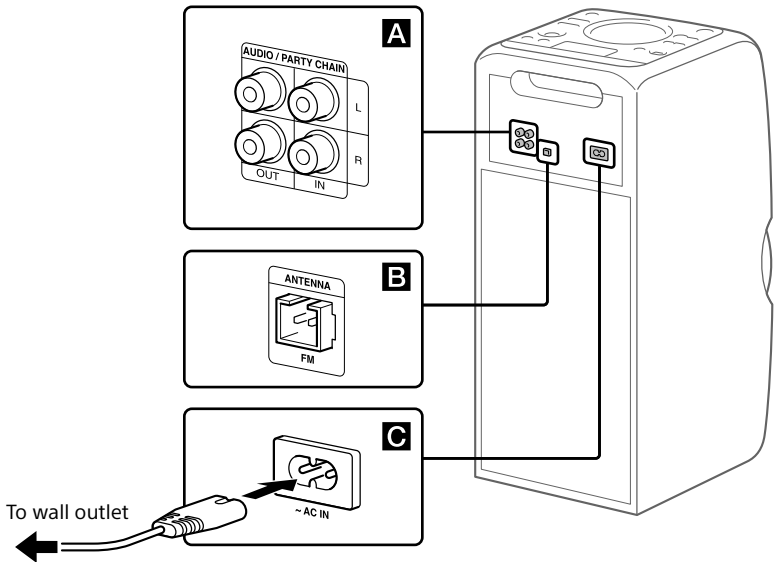

### A Audio output and input jacks

Use an audio cord (not supplied) to make either connection as follows:

- **AUDIO/PARTY CHAIN OUT L/R jacks**
  - Connect to the audio input jacks of an optional equipment.
  - Connect to another audio system to enjoy the Party Chain function (page 28).
- **AUDIO/PARTY CHAIN IN L/R jacks**
  - Connect to the audio output jacks of a TV or an audio/video equipment. The sound is output through this system.
  - Connect to another audio system to enjoy the Party Chain function (page 28).

### B Antenna

Connect the FM lead antenna (supplied).

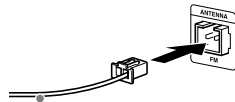

Extend the antenna horizontally.

### Hint

- Install the system in a location/orientation with good reception.

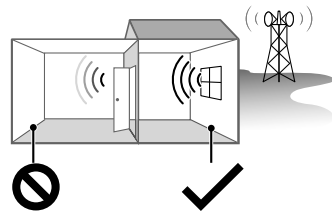

Areas with poor reception:  
Far from windows, etc.

Areas with good reception:  
Near windows, etc.

- Avoid the following kinds of locations.

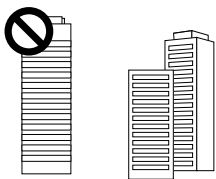

Between buildings



Nearby mobile phones,  
electrical appliances

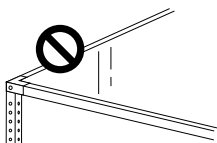

On steel desks or tables

- Keep the antenna away from the AC power cord and the USB cable to avoid picking up noise.

### **C** Power

Connect the AC power cord (supplied) to the system, and then to the wall outlet.

When the AC power cord is connected, the demonstration (page 14) starts automatically. If you press  to turn on the system, the demonstration ends.

## Deactivating the demonstration

To deactivate the demonstration while the system is turned off, press **SPEAKER LIGHT** repeatedly to select Standby Mode (page 14).

## Inserting batteries

Insert two R03 (size AAA) batteries (supplied), matching the polarities shown below.

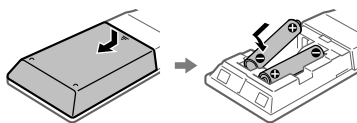

### Notes

- Do not mix an old battery with a new one or mix different types of batteries.
- If you do not use the remote control for a long period of time, remove the batteries to avoid damage from battery leakage and corrosion.

## Carrying the system

Before carrying the system, make sure that there is no disc loaded and no USB device is connected, and disconnect all the cords.

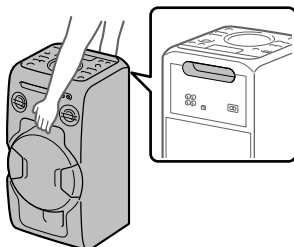

### Note

Correct hand placement while carrying the system is very important to avoid personal injury and/or property damage.

---

## Changing the display mode

**Press SPEAKER LIGHT repeatedly while the system is turned off.**

Each time you press the button, the display mode changes as follows.

---

### **Demonstration**

The illumination is turned on.

---

### **No display (Standby Mode)**

The display and the illumination are turned off to conserve power.

---

---

## About the power management

By default, this system is set to turn off automatically in about 15 minutes when there is no operation, and no audio signal is detected. For details, see "Setting the automatic standby function" (page 32).

## Playing a CD/MP3 disc

### Hint

For playable discs, see "Precautions" (page 38).

**1 Press FUNCTION repeatedly until "CD" appears on the display.**

**2 Place a disc.**

Press **▲** on the unit to open the disc tray, then place a disc with the label side up in the disc tray.



When you play back an 8 cm (3 1/4 in) disc such as a CD single, place it on the inner circle of the tray.

**3 Press ▲ on the unit to close the disc tray.**

Do not forcibly push the disc tray to close it as this may cause a malfunction.

**4 Press ► to start playback.**

### Other operations

| To                             | Do this  |
|--------------------------------|--|
| Pause playback                 | Press <b>II</b> . To resume play, press <b>►</b> .   |
| Stop playback                  | Press <b>■</b> . To resume play, press <b>►</b> . To cancel resume play, press <b>■</b> twice. |
| Select a folder on an MP3 disc | Press <b>☐ +/-</b> repeatedly.   |
| Select a track or file         | Press <b>I◀/▶I</b> .   |

| To                              | Do this  |
|---------------------------------|--|
| Find a point in a track or file | Hold down <b>◀/▶</b> during playback, and release the button at the desired point.   |
| Select Repeat Play              | Press <b>REPEAT/FM MODE</b> repeatedly until " <b>REP ONE</b> <sup>1)</sup> ," " <b>REP FLDR</b> <sup>2)</sup> ," " <b>REP ALL</b> <sup>3)</sup> " or " <b>REP OFF</b> <sup>4)</sup> " appears on the display.   |
| Change the play mode            | Press <b>PLAY MODE</b> repeatedly while the player is stopped. You can select normal play (" <b>FLDR</b> " for all MP3 files in the folder on the disc), shuffle play (" <b>SHUF</b> " or " <b>FLDRSHUF</b> " for folder shuffle), or program play (" <b>PROGRAM</b> "). |

<sup>1)</sup> "REP ONE": Repeats the current track or file.

<sup>2)</sup> "REP FLDR" (MP3 disc only): Repeats the current folder.

<sup>3)</sup> "REP ALL": Repeats all tracks or files.

<sup>4)</sup> "REP OFF": Turns off Repeat Play.

### Notes on playing MP3 discs

- Do not save other types of files or unnecessary folders on a disc that has MP3 files.
- Folders that have no MP3 files are skipped.
- MP3 files are played back in the order that they are recorded onto the disc.
- The system can only play MP3 files that have a file extension of ".mp3."
- Even when file name has the correct file extension, if the actual file differs, playing this file may generate a loud noise by which the system may malfunction.
- The maximum number of:
  - folders is 256 (including the root folder).
  - MP3 files is 999.
  - folder levels (the tree structure of files) is 8.
- Compatibility with all MP3 encoding/writing software, recording device, and recording media cannot be guaranteed. Incompatible MP3 discs may produce noise or interrupted audio or may not play at all.

## Note on playing multisession discs

The system can play back continuous sessions on a disc when they are recorded in the same session format as the first session. When a session recorded in a different session format is encountered, that session and the ones following it cannot be played back. Note that even if the sessions are recorded in the same format, some sessions may not play back.

## Creating your own program (Program Play)

**1 Press FUNCTION repeatedly until "CD" appears on the display.**

**2 Select the play mode.**

Press PLAY MODE repeatedly until "PROGRAM" appears on the display while the player is stopped.

**3 Select the desired track or file number.**

Press ◀◀/▶▶ repeatedly until the desired track or file number appears on the display.

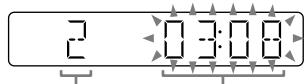

Selected track or file number

Total playing time of the selected track (CD-DA disc only)

When programming MP3 files in a specific folder, press  $\square$  +/- repeatedly to select the desired folder, and then select the desired file.

**4 Program the selected track or file.**

Press  $\square$  to enter the selected track or file.

**5 Repeat steps 3 through 4 to program additional tracks or files, up to a total of 64 tracks or files.**

**6 To play your program of tracks or files, press ▶.**

The program is cleared when you perform one of the following operations:

- changing the function.
- turning off the system.
- disconnecting the AC power cord.
- opening the disc tray.

To play the same program again, press ▶.

**To cancel Program Play**

Press PLAY MODE.

**To delete the last step from the program list**

Press CLEAR when playback is stopped.



## Listening to the radio

**1** Press **FUNCTION** repeatedly until "FM" appears on the display.

**2** Perform tuning.

### For automatic scanning

Press **TUNING MODE** repeatedly until "AUTO" appears on the display, and then press **TUNING+/-**. Scanning stops automatically when a station is found.

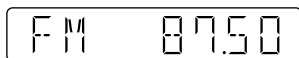

If the scanning does not stop, press **■** to stop scanning, then perform manual tuning (below).

### For manual tuning

Press **TUNING MODE** repeatedly until "MANUAL" appears on the display, and then press **TUNING+/-** repeatedly to tune to the desired station.

When you tune to a station that provides RDS services, the station name appears on the display (except for North American model).

### Hint

To reduce static noise on a weak FM stereo station, press **REPEAT/FM MODE** repeatedly until "MONO" appears on the display to turn off stereo reception. You will lose stereo effect, but reception will improve.

## Presetting radio stations

**1** Tune to the desired station.

**2** Press **TUNER MEMORY** to select the tuner memory mode.

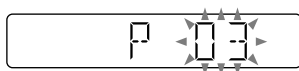

**3** Press **PRESET+/-** repeatedly to select the desired preset number.

If another station is already assigned to the selected preset number, the station is replaced by the new station.

**4** Press **+** to store the station.

**5** Repeat steps 1 through 4 to store other stations.

You can preset up to 20 FM stations.

The preset stations are retained for about half a day even if you disconnect the AC power cord or if a power failure occurs.

### To listen to the preset station

Press **TUNING MODE** repeatedly until "PRESET" appears on the display then press **PRESET+/-** repeatedly to select the desired preset number.

### Before using the USB device

For compatible USB devices, see "Information about compatible devices" (page 33).

When using Apple devices with this system, connect them via a BLUETOOTH connection (page 22). Using Apple devices via a USB connection is not supported.

#### Notes

- When USB cable connection is necessary, use the USB cable supplied with the USB device. See the operating instructions supplied with the USB device for details on the operation method.
- It may take a long time before "SEARCH" appears on the display depending on the type of USB device connected.
- Do not connect the system and the USB device through a USB hub.
- When the USB device is connected, the system reads all the files on the USB device. If there are many folders or files on the USB device, it may take a long time to finish reading the USB device.
- With some connected USB devices, there may be a delay before an operation is performed by this system.
- Compatibility with all encoding/writing software cannot be guaranteed. If audio files on the USB device were originally encoded with incompatible software, those files may produce noise or interrupted audio, or may not play at all.
- This system does not necessarily support all the functions provided in a connected USB device.
- Do not remove the USB device during transfer or erase operations. Doing so may corrupt the data on the USB device or damage the USB device itself.

### To use the system as a battery charger

You can use the system as a battery charger for USB devices that have a rechargeable function.

Connect the USB device to the  (USB) port.

The charging begins when the USB device is connected to the  (USB) port. For details, refer to the operating instructions of your USB device.

### Transferring music from a disc

You can transfer music from a disc (CD-DA disc or MP3 disc) to a USB device as follows:

- **CD SYNC transfer:** Transfers all the CD-DA tracks from the CD-DA disc.
- **MP3 folder transfer:** Transfers MP3 files in a specific folder from the MP3 disc.
- **REC1 transfer:** Transfers a currently playing track or MP3 file from the disc.

**1 Press FUNCTION repeatedly until "CD" appears on the display.**



**2 Connect the USB device to the  (USB) port.**

**3 Load a disc you want to transfer.**

**4 Prepare for transfer.**

Proceed to step 5 in case of CD SYNC transfer.

#### For MP3 folder transfer

To transfer MP3 files in a specific folder, press  +/- repeatedly to select the folder you want. Then start playback and press  once. Make sure the elapsed playing time has stopped on the display.

**For REC1 transfer**

Press **◀◀/▶▶** to select the track or MP3 file you want to transfer, then start playback.

To transfer an MP3 file in a specific folder, press **□ +/-** repeatedly to select the folder you want, then press **◀◀/▶▶** to select the MP3 file you want to transfer. Then start playback.

**5 Press REC TO USB.**

"READY" appears on the display.

**6 Press **□ +**.**

The transfer starts, then "USB REC" appears on the display. Do not remove the USB device until the transfer is complete. When the transfer is complete, "COMPLETE" appears on the display and audio files in MP3 format will be created.

**To stop transfer**

Press **■**.

**Folder and file generation rules**

When transferring to a USB device, a "MUSIC" folder is created directly below "ROOT." Folders and files are generated within this "MUSIC" folder according to the transfer method and source as follows:

**CD SYNC transfer**

| Source | Folder name | File name   |
|--------|-------------|-------------|
| CD-DA  | "CDDA001"*  | "TRACK001"* |

**MP3 folder transfer**

| Source | Folder name        | File name |
|--------|--------------------|-----------|
| MP3    | Same as the source |           |

**REC1 transfer**

| Source | Folder name | File name          |
|--------|-------------|--------------------|
| MP3    | "MP3_REC1"  | Same as the source |
| CD-DA  | "CD_REC1"   | "TRACK001"*        |

\* Folder and file numbers are assigned serially thereafter.

**Notes**

- CD-TEXT information is not transferred in the created MP3 files. This system does not support the CD-TEXT standard.
- The transfer stops automatically if:
  - the USB device runs out of space during transfer.
  - the number of audio files and folders on the USB device reaches the limit for the number that the system can recognize.
- If a folder or file that you are trying to transfer already exists on the USB device with the same name, a sequential number is added after the name without overwriting the original folder or file.
- Do not use buttons on the remote control or unit during transfer to prevent transfer from stopping.

**Note on copyright-protected content**

The transferred music is limited to private use only. Use of the music beyond this limit requires permission of the copyright holders.

# Playing a file

The following audio file formats are supported:

- MP3: file extension “.mp3”
- WMA: file extension “.wma”

- 1 Press FUNCTION repeatedly until “USB” appears on the display.**
- 2 Connect the USB device to the  $\psi$  (USB) port.**
- 3 Press  $\blacktriangleright$  to start playback.**
- 4 Press VOL +/- to adjust the volume.**

## Other operations

| To                     | Do this   |
|------------------------|---|
| Pause playback         | Press <b>II</b> . To resume play, press $\blacktriangleright$ .   |
| Stop playback          | Press <b>■</b> . To resume play, press $\blacktriangleright$ <sup>1)</sup> . To cancel resume play, press <b>■</b> twice.   |
| Select a folder        | Press $\square$ +/- repeatedly.   |
| Select a file          | Press <b>I◀◀/▶▶I</b> .  |
| Find a point in a file | Hold down <b>◀◀/▶▶</b> during playback, and release the button at the desired point.  |
| Select Repeat Play     | Press REPEAT/FM MODE repeatedly until “REP ONE <sup>2)</sup> ,” “REP FLDR <sup>3)</sup> ,” “REP ALL <sup>4)</sup> ” or “REP OFF <sup>5)</sup> ” appears on the display.   |
| Change the play mode   | Press PLAY MODE repeatedly while the USB device is stopped. You can select normal play (“FLDR” for all files in the folder on the USB device), shuffle play (“SHUF” or “FLDRSHUF” for folder shuffle), or program play (“PROGRAM”). |

- <sup>1)</sup> When playing a VBR MP3/WMA file, the system may resume playback from a different point.
- <sup>2)</sup> “REP ONE”: Repeats the current file.
- <sup>3)</sup> “REP FLDR”: Repeats the current folder.
- <sup>4)</sup> “REP ALL”: Repeats all files on a USB device.
- <sup>5)</sup> “REP OFF”: Turns off Repeat Play.

## Notes

- This system cannot play audio files on the USB device in the following cases;
  - when the total number of audio files on a USB device exceeds 999.
  - when the number of folders on a USB device exceeds 256 (including the “ROOT” folder and empty folders).These numbers may vary depending on the file and folder structure. Do not save other types of files or unnecessary folders on a USB device that has audio files.
- The system can play back to a depth of 8 folders only.
- Files and folders are displayed in the order of their creation on the USB device.
- Folders that have no audio files are skipped.
- Note that even when file name has the correct file extension, if the actual file differs, the system may produce noise or may malfunction.

## To erase audio files or folders from the USB device

- 1 Press FUNCTION repeatedly until “USB” appears on the display.**
- 2 Connect the USB device to the  $\psi$  (USB) port.**
- 3 Press **I◀◀/▶▶I** or  $\square$  +/- repeatedly to select the audio file or folder you want to erase, then start playback.**
- 4 Press OPTIONS.**
- 5 Press  $\uparrow/\downarrow$  repeatedly to select “ERASE,” then press  $\square$ .**
- 6 Press  $\uparrow/\downarrow$  to select “FOLDER” or “FILE,” then press  $\square$ .** “ERASE??” flashes on the display.
- 7 Press  $\square$ .** When erasing is complete, “COMPLETE” appears on the display.

## Creating your own program (Program Play)

- 1 Press **FUNCTION** repeatedly until **"USB"** appears on the display.
- 2 Select the play mode.  
Press **PLAY MODE** repeatedly until **"PROGRAM"** appears on the display while the player is stopped.
- 3 Select the desired file number.  
Press **◀◀/▶▶** repeatedly until the desired file number appears on the display.

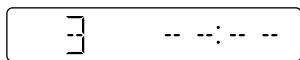

Selected file number

When programming MP3/WMA files in a specific folder, press **⏮** +/- repeatedly to select the desired folder, and then select the desired file.

- 4 Program the selected file.  
Press **+** to enter the selected file.
- 5 Repeat steps 3 through 4 to program additional files, up to a total of 64 files.
- 6 To play your program of files, press **▶**.  
The program is cleared when you perform one of the following operations:
  - changing the function.
  - turning off the system.
  - disconnecting the AC power cord.To play the same program again, press **▶**.

### To cancel Program Play

Press **PLAY MODE**.

### To delete the last step from the program list

Press **CLEAR** when playback is stopped.

## BLUETOOTH

### About the BLUETOOTH wireless technology

BLUETOOTH wireless technology is a short-range wireless technology that enables wireless data communication between digital devices. BLUETOOTH wireless technology operates within a range of about 10 meters (33 feet).

### Supported BLUETOOTH version, profiles and codecs

For details, see "BLUETOOTH section" (page 41).

### About the BLUETOOTH indicator

The BLUETOOTH indicator on the unit lights up or flashes in blue to show the BLUETOOTH status.

| System status                       | Indicator status |
|-------------------------------------|------------------|
| BLUETOOTH standby                   | Flashes slowly   |
| BLUETOOTH pairing                   | Flashes quickly  |
| BLUETOOTH connection is established | Lights up        |

## Pairing this system with a BLUETOOTH device

Pairing is an operation where BLUETOOTH devices register with each other beforehand. Once a pairing operation is performed, it does not need to be performed again.

If your device is an NFC-compatible smartphone, the manual pairing procedure is not necessary. (See "One Touch BLUETOOTH Connection by NFC" (page 23).)

**1 Place the BLUETOOTH device within 1 meter (3 feet) from the system.**

**2 Press BLUETOOTH on the unit to select the BLUETOOTH function.**

"BT AUDIO" appears on the display.

### Hints

- When there is no pairing information on the system (for example, when you use the BLUETOOTH function for the first time after purchase), "PAIRING" flashes on the display and the system enters the pairing mode automatically. In this case, proceed to step 4.
- If the BLUETOOTH connection is established, terminate the BLUETOOTH connection (page 23).

**3 Hold down BLUETOOTH on the unit for more than 3 seconds.**  
"PAIRING" flashes on the display.

**4 Perform the pairing procedure on the BLUETOOTH device.**

For details, refer to the operating instructions of your BLUETOOTH device.

**5 Select "MHC-V11" on the display of the BLUETOOTH device.**

### Note

If passkey is required on the BLUETOOTH device, enter "0000." "Passkey" may be called "Passcode," "PIN code," "PIN number," or "Password."

**6 Perform the BLUETOOTH connection on the BLUETOOTH device.**

When pairing is completed and the BLUETOOTH connection is established, "BT AUDIO" appears on the display.

Depending on the BLUETOOTH device, connection may start automatically after pairing is completed.

### Notes

- You can pair up to 8 BLUETOOTH devices. If the 9th BLUETOOTH device is paired, the oldest paired device will be deleted.
- If you want to pair with another BLUETOOTH device, repeat steps 1 to 6.

### To cancel the pairing operation

Press BLUETOOTH on the unit.

### Erasing all the pairing registration information

To erase all the pairing registration information, the system should be reset to the factory default settings. See "Resetting the system" (page 37).

---

## Listening to music on a BLUETOOTH device

You can operate a BLUETOOTH device by connecting the system and the BLUETOOTH device using AVRCP. Check the following before playing music:

- The BLUETOOTH function of the BLUETOOTH device is turned on.
- Pairing has been completed (page 22).

Once the system and the BLUETOOTH device are connected, you can control playback by pressing ►, ||, ■, and ◀◀/▶▶.

**1 Press BLUETOOTH on the unit to select the BLUETOOTH function.**  
“BT AUDIO” appears on the display.

**2 Establish connection with the BLUETOOTH device.**

The last connected BLUETOOTH device will be connected automatically. Perform the BLUETOOTH connection from the BLUETOOTH device if the device is not connected.

**3 Press ► to start playback.**  
Depending on the BLUETOOTH device,  
— you may need to press ► twice.  
— you may need to start playing an audio source on the BLUETOOTH device.

**4 Adjust the volume.**  
Adjust the volume of the BLUETOOTH device first. If the volume level is still too low, adjust the volume level on the system using VOL +/-.

### Note

If you try to connect another BLUETOOTH device to the system, the currently connected BLUETOOTH device will be disconnected.

## To terminate the BLUETOOTH connection

- 1 Press OPTIONS.
- 2 Press ▲/▼ repeatedly to select “DISCONNECT,” then press [⏏].

Depending on the BLUETOOTH device, the BLUETOOTH connection may be terminated automatically when you stop playback.

---

## One Touch BLUETOOTH Connection by NFC

NFC (Near Field Communication) is a technology enabling short-range wireless communication between various devices, such as smartphones and IC tags.

When you touch the system with an NFC-compatible smartphone, the system automatically:

- turns on in the BLUETOOTH function.
- completes the pairing and BLUETOOTH connection.

### Compatible smartphones

Smartphones with a built-in NFC function (OS: Android™ 2.3.3 or later, excluding Android 3.x)

### Notes

- The system can only recognize and connect to one NFC-compatible smartphone at a time. If you try to connect another NFC-compatible smartphone to the system, the currently connected NFC-compatible smartphone will be disconnected.
- Depending on your NFC-compatible smartphone, you may need to turn on the smartphone's NFC function in advance. For details, refer to the operating instructions for the smartphone.

- 1 Touch the mobile device, such as a smartphone or tablet, to the N-Mark on the unit until the mobile device vibrates.



Complete the connection by following the instructions displayed on the smartphone.

When the BLUETOOTH connection is established, the BLUETOOTH indicator on the unit stops flashing and remains lit. "BT AUDIO" appears on the display.

- 2 Start playback of an audio source on the smartphone.

For details, refer to the operating instructions of your BLUETOOTH device.

#### Hint

If pairing and the BLUETOOTH connection fail, perform the following.

- Remove the case from the smartphone if using a commercially available smartphone case.
- Touch the smartphone to the N-Mark on the unit again.

#### To terminate the BLUETOOTH connection

Touch the smartphone to the N-Mark on the unit again.

---

## Playing back with high quality sound codec (AAC/LDAC™)

This system can receive data in the AAC or LDAC codec format from a BLUETOOTH device. It provides a playback with higher sound quality.

The default setting of this system is "AUTO."

To apply the changes of the setting, you need to terminate the BLUETOOTH connection (page 23), and then perform the BLUETOOTH connection again.

- 1 Press **BLUETOOTH** on the unit to select the **BLUETOOTH** function.

"BT AUDIO" appears on the display.

- 2 Press **OPTIONS**.

- 3 Press **↕/↕** repeatedly to select "BT:CODEC," then press **[+]**.

- 4 Press **↕/↕** repeatedly to select the setting, then press **[+]**.

- **AUTO:** The system detects the codec used on the source device and automatically selects the optimal codec from "SBC," "AAC\*" or "LDAC\*."
- **SBC:** "SBC" is always applied regardless of the codec used on the source device.

\* Available only when the codec is supported by your BLUETOOTH device.

#### Note

You can enjoy higher sound quality when the source device is compatible with AAC/LDAC and this function is set to "AUTO." However, the sound may be interrupted depending on the conditions of the BLUETOOTH communication. If this happens, set the function to "SBC."



LDAC is an audio coding technology developed by Sony, that enables the transmission of High-Resolution (Hi-Res) Audio content, even over a BLUETOOTH connection. Unlike other BLUETOOTH compatible coding technologies, such as SBC, it operates without any down-conversion of the Hi-Res Audio content<sup>1)</sup>. It also allows approximately three times more data<sup>2)</sup> than the other technologies, for transmitting over a BLUETOOTH wireless network with unprecedented sound quality using efficient coding and optimized data bundling.

<sup>1)</sup> Excluding DSD format contents.

<sup>2)</sup> In comparison with SBC (Sub Band Codec), when the bit rate of 990 kbps (96/48 kHz) or 909 kbps (88.2/44.1 kHz) is selected.

---

## Turning on or off the BLUETOOTH signal

You can connect to the system from a paired BLUETOOTH device in all functions when the system's BLUETOOTH signal is set to on. The BLUETOOTH signal is turned on by default.

Use the buttons on the unit to perform this operation.

### Hold down **■** and **TUNING-** for about 5 seconds.

"BT ON" or "BT OFF" appears on the display.

#### **Note**

You cannot perform the following operations when you turn off the BLUETOOTH signal:

- Pairing and/or connecting with BLUETOOTH device
- Setting the BLUETOOTH audio codecs
- Using "Sony | Music Center" via BLUETOOTH

# Using “Sony | Music Center” via BLUETOOTH

## About App



You can control the system using the free App “Sony | Music Center,” which is available on both Google Play and the App Store. Search for “Sony | Music Center” or scan the two-dimensional code below, then download the App to find out more about the convenient features.



## Notes

- If the “Sony | Music Center” application does not work properly, terminate the BLUETOOTH connection (page 23), then perform the BLUETOOTH connection again so that the BLUETOOTH connection functions normally.
- What you can control with “Sony | Music Center” varies depending on the connected device.
- The specification and design of the application may change without notice.

## Sound Adjustment

### Adjusting the sound

| To                            | Do this  |
|-------------------------------|--|
| Adjust the volume             | Press VOL +/-.   |
| Generate a more dynamic sound | Press MEGA BASS repeatedly until “BASS ON” appears on the display. |
| Set the sound effect          | Press EQ repeatedly until desired sound effect is displayed.       |

---

# Creating a party atmosphere

## (DJ EFFECT)

DJ EFFECT cannot be used while a microphone is connected to the unit. If a microphone is connected, remove it before using DJ EFFECT. Use the buttons on the unit to perform this operation.

### 1 Press the following button to select the effect type.

- **FLANGER:** Creates a deep flanging effect that is similar to the roar of a jet plane.
- **ISOLATOR:** Isolates a specific frequency band by adjusting the other frequency bands. This is useful when you want to focus on the vocals.

### 2 Turn the **VOLUME/DJ CONTROL** knob to adjust the effect level.

#### To turn off the effect

Press DJ OFF.

#### Notes

- The DJ EFFECT is automatically turned off when you:
  - turn off the system.
  - activate or deactivate the Party Chain function.
  - connect a microphone to the MIC 1 or MIC 2 jack on the unit.
- The DJ EFFECT does not affect the transferred audio files. Transferred audio files will be generated without the DJ EFFECT even if you have activated it.
- You cannot use VOLUME/DJ CONTROL on the unit to adjust the volume when the DJ EFFECT is activated. Press VOL +/- on the remote control to adjust the volume.

### Using the Party Chain function

You can connect multiple audio systems in a chain to create a more interesting party environment and to produce higher sound output. An activated system in the chain will be the "Party Host" and share the music. Other systems will become "Party Guests" and play the same music as that being played by the "Party Host."

#### Setting up the Party Chain

Set up a Party Chain by connecting all the systems using audio cords (not supplied).

Before connecting cords, be sure to disconnect the AC power cord.

#### **A** If all the systems are equipped with the Party Chain function

Example: When connecting using this system as the first system

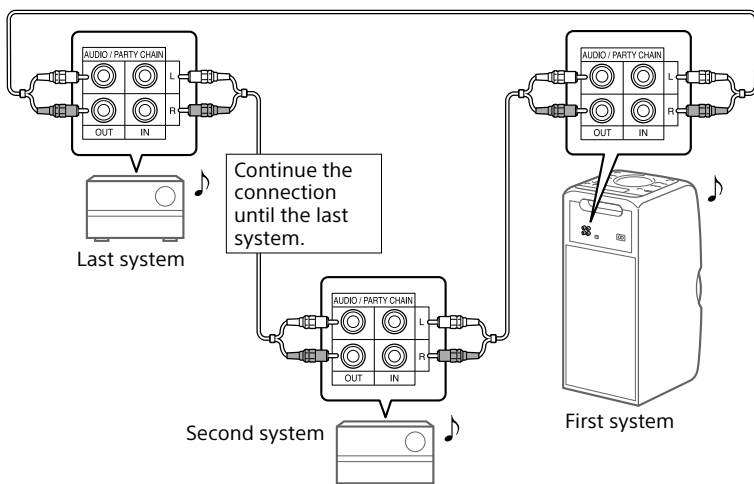

- The last system must be connected to the first system.
- Any system can become a Party Host.
- You can change the Party Host to another system in the chain. For details, see "To select a new Party Host" (page 30).
- Make sure the function other than the Audio In function is selected. When the Audio In function is selected, the Party Chain function cannot be activated.

## B If one of the systems is not equipped with the Party Chain function

Example: When connecting using this system as the first system

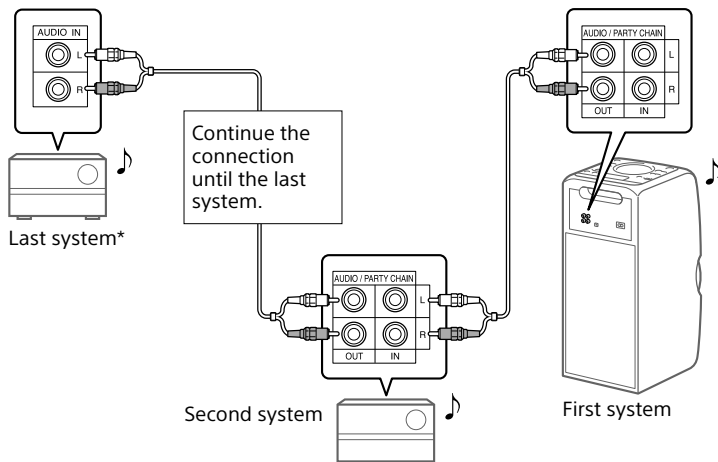

\* Connect the system which is not equipped with the Party Chain function at the last system. Be sure to select the Audio In function on this last system.

- The last system is not connected to the first system.
- You must select the first system as Party Host so that all systems are playing the same music when Party Chain function is activated.

## Enjoying the Party Chain

- 1 Plug in the AC power cord and turn on all the systems.**
- 2 Adjust the volume on each system.**
- 3 Activate the Party Chain function on the system to be used as the Party Host.**

### Example: When using this system as the Party Host

- ① Press FUNCTION repeatedly to select the function you want.**  
When you connect using **A** (page 28), do not select the Audio In function. If you select this function, the Party Chain function cannot be activated.
- ② Start playback, then hold down MEGA BASS on the unit until "PARTY CHAIN HOST" appears on the display.**  
The Party Host starts the Party Chain, and other systems become Party Guests automatically. All systems play the same music as that being played by the Party Host.

### Notes

- Depending on the total unit of systems you have connected, Party Guests may take some time to start playing the music.
- Changing the volume level and sound effect on the Party Host will not affect the output on the Party Guests.
- When you use the microphone on Party Host, the sound will not be output from Party Guests.
- When one of the systems in the chain is performing USB transfer, wait for the system to complete or stop the transfer before you activate the Party Chain function.
- For detailed operation on other systems, refer to the operating instructions of the systems.

## To select a new Party Host

Repeat step 3 of "Enjoying the Party Chain" on the system to be used as a new Party Host. The current Party Host becomes Party Guest automatically. All systems play the same music as that being played by the new Party Host.

### Notes

- You can select another system as the new Party Host only after the Party Chain function of all the systems in the chain has been activated.
- If the selected system does not become a new Party Host after a few seconds, repeat step 3 of "Enjoying the Party Chain."

## To deactivate the Party Chain

When using this system as the Party Host, hold down MEGA BASS on the unit.

When using another system as the Party Host, press PARTY CHAIN on the Party Host.

### Note

If the Party Chain function is not deactivated after a few seconds, perform the above operation on the Party Host again.

---

## Singing along: Karaoke

### Preparing for Karaoke

- 1 Turn MIC LEVEL on the unit to MIN to reduce the microphone volume level.**

Microphone volume range

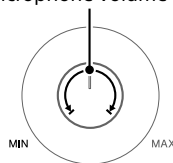

- 2 Connect an optional microphone to MIC 1 or MIC 2 jack on the unit.**

Connect another optional microphone if you want to sing in duet.

**3 Start playing the music and adjust the microphone volume. Press MIC ECHO repeatedly to adjust the echo effect.**

**4 Start singing along with the music.**

#### Notes

- Karaoke mode is turned on when the microphone is connected.
- If howling occurs:
  - move the microphone away from the system.
  - change the direction of the microphone.
  - lower the microphone volume level.
  - press VOL - to reduce the volume level or press MIC ECHO repeatedly to adjust the echo level.
- Microphone sound will not be transferred to the USB device during USB transfer.
- DJ EFFECT cannot be used while a microphone is connected to the unit (page 27).

### Using Vocal Fader

You can reduce the sound of the vocal in stereo source.

**Press VOCAL FADER repeatedly until "FADE ON" appears on the display.**

To cancel Vocal Fader effect, press VOCAL FADER repeatedly until "FADE OFF" appears on the display.

#### Note

To use the Vocal Fader in the CD or USB function, turn on the Karaoke mode by connecting the microphone.

### Changing the key (Key Control)

**Press KEY CONTROL #/b to suit your vocal range in Karaoke mode.**

## Enjoying music with the Speaker Lights turned on

**Press SPEAKER LIGHT.**

The Speaker Lights are turned on.

**To turn off the Speaker Lights**

Press SPEAKER LIGHT again.

#### Note

If the illumination brightness is glaring, switch on the room lights or turn off the illumination.

## Using an optional equipment

**1 Connect an optional equipment to the AUDIO IN L/R jacks on the unit using an audio cord (not supplied).**

**2 Press FUNCTION repeatedly until "AUDIO IN" appears on the display.**

**3 Start playback on the connected equipment.**

**4 Adjust the volume.**

Adjust the volume of the connected equipment first. If the volume level is still too low, adjust the volume level on the system using VOL +/-.

#### Note

The system may enter standby mode automatically if the volume level of the connected equipment is too low. In this case, increase the volume level of the equipment. To turn off the automatic standby function, see "Setting the automatic standby function" (page 32).

---

## Changing information on the display

You can view information, such as track number, file/folder name, album name and artist name.

**Press DISPLAY repeatedly when the system is on.**

### Notes on the display information

- Characters that cannot be displayed appear as “\_”.
- The following are not displayed;
  - total playing time for an MP3 disc and a USB device.
  - remaining playing time for an MP3/WMA file.
- The following are not displayed correctly;
  - elapsed playing time of an MP3/WMA file encoded using VBR (variable bit rate).
  - folder and file names that do not follow either the ISO9660 Level 1/Level 2 in the expansion format.

---

## Using the Sleep Timer

The system turns off automatically after the preset time.

**Press SLEEP repeatedly to select the desired time.**

To cancel Sleep Timer, press SLEEP repeatedly to select “OFF.”

### Note

When opening and closing the disc tray, the remaining time before the system turns off may be extended.

### Hints

- To check the remaining time before the system turns off, press SLEEP.
- If you select “AUTO,” the system automatically turns off after the current disc or USB device playback ends, or within 100 minutes.

---

## Deactivating the buttons on the unit (Child Lock)

You can deactivate the buttons on the unit (except ) to prevent misoperation, such as child mischief.

**Hold down DJ OFF and  on the unit for more than 3 seconds.**

“LOCK ON” appears on the display. You can only operate the system using the buttons on the remote control. To turn off the Child Lock function, hold down DJ OFF and  on the unit for more than 3 seconds until “LOCK OFF” appears on the display.

---

## Setting the automatic standby function

By default, this system is set to turn off automatically in about 15 minutes when there is no operation or audio signal output.

**To turn off the function, hold down  while the system is on, until “AUTO STANDBY OFF” appears on the display.**

To turn on the function, repeat the procedure until “AUTO STANDBY ON” appears on the display.

### Notes

- “STANDBY” flashes on the display before entering standby mode.
- The automatic standby function does not work in the following cases:
  - during tuner function.
  - when the Sleep Timer is activated.



# Information about compatible devices

## About supported USB devices

- This system supports USB Mass Storage Class only.
- This system supports FAT formatted USB devices only (except exFAT).
- Some USB devices may not work with this system.

## About BLUETOOTH communication for iPhone and iPod models

### Made for

- iPhone 6
- iPhone 6 Plus
- iPhone 5s
- iPhone 5c
- iPhone 5
- iPhone 4s
- iPod touch (6th generation)
- iPod touch (5th generation)

## Websites for compatible devices

Check the websites below for the latest information about compatible USB and BLUETOOTH devices.

**For customers in the USA:**  
<http://esupport.sony.com/>

**For customers in Canada:**  
<http://esupport.sony.com/CA>

**For customers in Europe:**  
<http://www.sony.eu/support>

**For customers in Latin America:**  
<http://esupport.sony.com/LA>

**For customers in other countries/regions:**  
<http://www.sony-asia.com/support>

# Troubleshooting

If a problem occurs while operating the system, follow the steps described below before consulting your nearest Sony dealer. If an error message appears, be sure to make a note of the contents for reference.

**1 Check to see if the problem is listed in this "Troubleshooting" section.**

**2 Check the following customer support websites.**

**For customers in the USA:**  
<http://esupport.sony.com/>

**For customers in Canada:**  
<http://esupport.sony.com/CA>

**For customers in Europe:**  
<http://www.sony.eu/support>

**For customers in Latin America:**  
<http://esupport.sony.com/LA>

**For customers in other countries/regions:**  
<http://www.sony-asia.com/support>

You will find the latest support information and a FAQ at these websites.

Note that if the service personnel changes some parts during repair, these parts may be retained.

### If "PROTECT" appears on the display

Immediately unplug the AC power cord, and check the following items after "PROTECT" disappears.

- Is anything blocking the ventilation holes of the system?
- Is the USB port short-circuited? After you have checked these above items and found no problems, reconnect the AC power cord, and turn on the system. If the issue persists, contact your nearest Sony dealer.

## General

---

### The system does not turn on.

- Check that the AC power cord is connected securely.

### The system cannot be turned off even though is pressed.

- You may have set the display mode to the demonstration mode unintentionally. Press SPEAKER LIGHT repeatedly to select Standby Mode (page 14).

### The system has entered standby mode.

- This is not a malfunction. The system enters standby mode automatically in about 15 minutes when there is no operation or audio signal output (page 32).

### There is no sound.

- Adjust the volume.
- Check the connection of the optional equipment, if any (page 12).
- Turn on the connected equipment.
- Disconnect the AC power cord, then reconnect the AC power cord and turn on the system.

### There is no microphone sound.

- Adjust the microphone volume level.
- Make sure the microphone is connected to the MIC 1 or MIC 2 jack on the unit correctly.
- Make sure the microphone is turned on.

### There is severe hum or noise.

- Move the system away from sources of noise.
- Connect the system to a different wall outlet.
- Install a noise filter (commercially available) to the AC power cord.
- Turn off surrounding electrical equipment.
- The noise generated by the cooling fans of the system may be heard when the system is in standby mode or during playback. This is not a malfunction.

### The remote control does not function.

- Remove the obstacles between the remote control and the unit.
- Move the remote control closer to the system.
- Point the remote control at the system's sensor.
- Replace the batteries (R03/size AAA).
- Move the system away from the fluorescent light.

### There is acoustic feedback.

- Reduce the volume.
- Move the microphone away from the system or change the direction of the microphone.

### Except , no buttons on the unit work, and "LOCK ON" appears on the display.

- Set the Child Lock function to off (page 32).

### "SEARCH," "READING" or "TUNING" appears on the display.

- Operate the system after the message disappears.

## Disc player

---

### The disc tray does not open and "LOCKED" appears on the display.

- Consult your nearest Sony dealer or local authorized Sony service facility.

### Playback does not start.

- Wipe the disc clean (page 38).
- Reload the disc.
- Load the disc that this system can play back (page 38).
- Remove the disc and wipe away the moisture on the disc, then leave the system turned on for a few hours until the moisture evaporates.

### The sound skips.

- Wipe the disc clean (page 38).
- Reload the disc.
- Move the system to a place with no vibration.

### **Playback does not start from the first track.**

- Set the play mode to normal play mode (page 15).
- Resume Play has been selected. Press ■ twice. Then, press ► to start playback.

### **Starting playback takes more time than usual.**

- The following discs can increase the time it takes to start playback;
  - a disc recorded with a complicated tree structure.
  - a disc recorded in multisession mode.
  - a disc that has not been finalized (a disc to which data can be added).
  - a disc that has many folders.

## **USB device**

---

### **The connected USB device cannot be charged.**

- Make sure the USB device is connected securely.

### **The USB device does not work properly.**

- If you connect an unsupported USB device, the following problems may occur. See "Information about compatible devices" (page 33).
  - The USB device is not recognized.
  - File or folder names are not displayed on this system.
  - Playback is not possible.
  - The sound skips.
  - There is noise.
  - A distorted sound is output.

### **There is no sound.**

- The USB device is not connected correctly. Turn off the system, and reconnect the USB device, then turn on the system and check if "USB" appears on the display.

### **There is noise, skipping, or distorted sound.**

- You are using an unsupported USB device. See "Information about compatible devices" (page 33).
- Turn off the system and reconnect the USB device, then turn on the system.
- The music data itself contains noise, or the sound is distorted. Noise may have been entered during the transfer process. Delete the file, and try transfer again.
- The bit rate used when encoding an audio file was low. Send an audio file with higher bit rates to the USB device.

### **"SEARCH" is displayed for an extended time, or it takes a long time before playback starts.**

- The reading process can take a long time in the following cases.
  - There are many folders or files on the USB device.
  - The file structure is extremely complex.
  - The memory capacity is excessive.
  - The internal memory is fragmented.

### **"OVER CURRENT" appears on the display**

- A problem has been detected with the level of electrical current from the ⚡ (USB) port. Turn off the system and remove the USB device from the ⚡ (USB) port. Make sure there is no problem with the USB device. If this display pattern persists, contact your nearest Sony dealer.

### **Erroneous display**

- Characters that cannot be displayed appear as " \_ ".

### **The USB device is not recognized.**

- Turn off the system and reconnect the USB device, then turn on the system.
- You are using an unsupported USB device. See "Information about compatible devices" (page 33).
- The USB device is not working properly. Refer to the operating instructions of the USB device on how to deal with this problem.

### **Transferring results in an error.**

- You are using an unsupported USB device. See “Information about compatible devices” (page 33).
- The USB device is not formatted correctly. Refer to the operating instructions of the USB device on how to format.
- Turn off the system and remove the USB device. If the USB device has a power switch, turn the USB device off and on again after removing it from the system. Then, perform the transfer again.
- If the transfer and erase operations are repeated multiple times, the file structure within the USB device becomes fragmented. Refer to the operating instructions of the USB device on how to deal with this problem.
- The USB device was disconnected or the power was turned off during transfer. Delete the partially-transferred file, and perform the transfer again. If this does not fix the problem, the USB device may be broken. Refer to the operating instructions of the USB device on how to deal with this problem.

### **Audio files or folders on the USB device cannot be erased.**

- Check if the USB device is write-protected.
- The USB device was disconnected or the power was turned off during the erase operation. Delete the partially-erased file. If this does not fix the problem, the USB device may be broken. Refer to operating instructions of the USB device on how to deal with this problem.

### **Playback does not start.**

- Turn off the system and reconnect the USB device, then turn on the system.
- You are using an unsupported USB device. See “Information about compatible devices” (page 33).

### **Playback does not start from the first file.**

- Set the play mode to normal play mode (page 20).
- Resume Play has been selected. Press **■** twice. Then, press **▶** to start playback.

### **Files cannot be played back.**

- USB devices formatted with file systems other than FAT16 or FAT32 are unsupported.\*
  - If you use a partitioned USB device, only files on the first partition can be played back.
  - Files that are encrypted or protected by passwords cannot be played back.
  - Files with DRM (Digital Rights Management) copyright protection cannot be played back by this system.
- \* This system supports FAT16 and FAT32, but some USB storage devices may not support all of these FAT. For details, refer to the operating instructions of each USB storage device or contact the manufacturer.

### **Tuner\***

---

#### **There is severe hum or noise, or stations cannot be received.**

- Connect the antenna properly.
- Change antenna location and its orientation to obtain good reception.
- Keep the antenna away from the AC power cord to avoid picking up noise.
- Turn off nearby electrical equipment.

\* Radio may not be received depending on the radio wave conditions or the housing environment in your area.

### **BLUETOOTH device**

---

#### **Pairing cannot be performed.**

- Move the BLUETOOTH device closer to the system.
- Pairing may not be possible if other BLUETOOTH devices are present around the system. In this case, turn off the other BLUETOOTH devices.
- Make sure to enter the correct passkey when selecting the system’s name (this system) on the BLUETOOTH device.

**The BLUETOOTH device cannot detect the system, or “BT OFF” appears on the display.**

- Set the BLUETOOTH signal to “BT ON” (page 25).

**Connection is not possible.**

- The BLUETOOTH device you attempted to connect does not support the A2DP profile, and cannot be connected with the system.
- Enable the BLUETOOTH function of the BLUETOOTH device.
- Establish a connection from the BLUETOOTH device.
- The pairing registration information has been erased. Perform the pairing operation again.
- Erase the pairing registration information of the BLUETOOTH device by resetting the system to factory default settings (page 37) and perform the pairing operation again (page 22).

**The sound skips or fluctuates, or the connection is lost.**

- The system and the BLUETOOTH device are too far apart.
- If there are obstacles between the system and your BLUETOOTH device, remove or avoid the obstacles.
- If there is equipment that generates electromagnetic radiation, such as a wireless LAN, other BLUETOOTH device, or a microwave oven nearby, move them away.

**The sound of your BLUETOOTH device cannot be heard on this system.**

- Increase the volume on your BLUETOOTH device first, then adjust the volume using VOL +/-.

**There is severe hum, noise, or distorted sound.**

- If there are obstacles between the system and your BLUETOOTH device, remove or avoid the obstacles.
- If there is equipment that generates electromagnetic radiation, such as a wireless LAN, other BLUETOOTH device, or a microwave oven nearby, move them away.
- Turn down the volume of the connected BLUETOOTH device.

## Party Chain

**Party Chain function cannot be activated.**

- Check the connections (page 28).
- Make sure the audio cords are connected correctly.
- Select the function other than the Audio In function (page 30).



**Party Chain function does not work properly.**

- Turn off the system. Then, turn it back on again to activate the Party Chain function.

## Resetting the system

If the system still does not operate properly, reset the system to factory default settings.

**1 Disconnect and reconnect the AC power cord, and then turn on the system.**

**2 Hold down  and  – on the unit until “RESET” appears on the display.**

All user-configured settings, such as preset radio stations and the pairing registration information, are reset to factory default settings.

## Messages

One of the following messages may appear or flash on the display during operation.

### **DISC ERR**

You have loaded a disc that cannot be played.

### **ERROR**

You cannot transfer music to the USB device because the USB device is write-protected or the memory of the USB device is full.

### **FULL**

You tried to program more than 64 steps.

### **NO FILE**

There are no playable files on the CD-R/CD-RW discs or on the USB device.

### **NO STEP**

All of the programmed steps have been erased.

### **NO USB**

No USB device is connected or an unsupported USB device is connected.

### **PARTY CHAIN GUEST**

The system has become a Party Guest as the Party Chain function has been activated by a Party Host.

### **PARTY CHAIN HOST**

The system activated the Party Chain function and has become a Party Host.

### **PLS STOP**

You tried to perform an operation that can be performed only when the playback is stopped.

## Precautions

### **Discs that this system CAN play**

- Audio CD
- CD-R/CD-RW (audio data/MP3 files)

### **Discs that this system CANNOT play**

- CD-ROM
- CD-R/CD-RW other than those recorded in music CD format, conforming to ISO9660 Level 1/Level 2
- CD-R/CD-RW recorded in multisession that have not ended by "closing the session"
- CD-R/CD-RW of poor recording quality, CD-R/CD-RW that have scratches or are dirty, or CD-R/CD-RW recorded with an incompatible recording device
- CD-R/CD-RW which is finalized incorrectly
- Discs containing files other than MPEG1 Audio Layer-3 (MP3) files
- Discs of non-standard shape (for example, heart, square, star)
- Discs that have adhesive tape, paper, or sticker attached to them
- Rental or used discs with attached seals where the glue extends beyond the seal
- Discs that have labels printed using ink that feels tacky when touched

### **Notes on discs**

- Before playing, wipe the disc with a cleaning cloth from the center outward to the edge.
- Do not clean discs with solvents, such as benzene, thinner, or commercially available cleaners or anti-static spray intended for vinyl LPs.
- Do not expose discs to direct sunlight or heat sources such as hot air ducts, nor leave them in a car parked in direct sunlight.

### **On safety**

- Completely disconnect the AC power cord (mains lead) from the wall outlet (mains) if it is not going to be used for an extended period of time. When unplugging the unit, always grip the plug. Never pull the cord itself.
- Should any solid object or liquid get into the system, unplug the system, and have it checked by qualified personnel before operating it again.
- AC power cord must be changed only at the qualified service shop.

### On placement

- Do not place the system in an inclined position or in locations that are extremely hot, cold, dusty, dirty, or humid or lacking adequate ventilation, or subject to vibration, direct sunlight or a bright light.
- Be careful when placing the system on surfaces that have been specially treated (for example, wax, oil, polish) as staining or discoloration of the surface may result.
- If the system is brought directly from a cold to a warm location or is placed in a very damp room, moisture may condense on the lens inside the system, and cause the system to malfunction. In this situation, remove the disc, and leave the system turned on for about an hour until the moisture evaporates.

### On heat buildup

- Heat buildup on the system during operation is normal and is not a cause for alarm.
- Do not touch the cabinet if it has been used continuously at a high volume because the cabinet may have become hot.
- Do not obstruct the ventilation holes.

### On the speaker system

The built-in speaker system is not magnetically shielded, and the picture on nearby TV sets may become magnetically distorted. In this situation, turn off the TV, wait 15 to 30 minutes, and turn it back on. If there is no improvement, move the system far away from the TV.

### Cleaning the cabinet

Clean this system with a soft cloth slightly moistened with a mild detergent solution. Do not use any type of abrasive pad, scouring powder, or solvent, such as thinner, benzene, or alcohol.

### On BLUETOOTH Communication

- BLUETOOTH devices should be used within approximately 10 meters (33 feet) (unobstructed distance) of each other. The effective communication range may become shorter under the following conditions.
  - When a person, metal object, wall or other obstruction is between the devices with a BLUETOOTH connection
  - Locations where a wireless LAN is installed
  - Around microwave ovens that are in use
  - Locations where other electromagnetic waves are generated
- BLUETOOTH devices and wireless LAN (IEEE 802.11b/g) equipment use the same frequency band (2.4 GHz). When using your BLUETOOTH device near a device with wireless LAN capability, electromagnetic interference may occur. This could result in lower data transfer rates, noise, or inability to connect. If this happens, try the following remedies:
  - Use this system at least 10 meters (33 feet) away from the wireless LAN equipment.
  - Turn off the power to the wireless LAN equipment when using your BLUETOOTH device within 10 meters (33 feet).
  - Use this system and BLUETOOTH device as close to each other as possible.
- The radio waves broadcast by this system may interfere with the operation of some medical devices. Since this interference may result in malfunction, always turn off the power on this system and BLUETOOTH device in the following locations:
  - In hospitals, on trains, in airplanes, at gas stations, and any place where flammable gases may be present
  - Near automatic doors or fire alarms
- This system supports security functions that comply with BLUETOOTH specifications to ensure secure connections during communication using BLUETOOTH technology. However, this security may be insufficient depending on the setting contents and other factors, so always be careful when performing communication using BLUETOOTH technology.
- Sony cannot be held liable in any way for damages or other loss resulting from information leaks during communication using BLUETOOTH technology.
- BLUETOOTH communication is not necessarily guaranteed with all BLUETOOTH devices that have the same profile as this system.

- BLUETOOTH devices connected with this system must comply with the BLUETOOTH specification prescribed by the Bluetooth SIG, Inc., and must be certified to comply. However, even when a device complies with the BLUETOOTH specification, there may be cases where the characteristics or specifications of the BLUETOOTH device make it impossible to connect, or may result in different control methods, display or operation.
- Noise may occur or the audio may cut off depending on the BLUETOOTH device connected with this system, the communications environment, or surrounding conditions.

---

## Specifications

### AUDIO POWER SPECIFICATIONS

POWER OUTPUT AND TOTAL HARMONIC DISTORTION:

(The United States model only)

Left/Right Channel:

With 3 ohms loads, both channels driven, from 120 – 10,000 Hz; rated 30 watts per channel minimum RMS power, with no more than 0.7% total harmonic distortion from 250 milliwatts to rated output.

### Speaker section

Speaker system:

Tweeter + Woofer

Tweeter L/R:

50 mm (2 in), cone type

Woofer:

200 mm (7 7/8 in), cone type

### Inputs

AUDIO/PARTY CHAIN IN L/R:

Voltage 2 V, impedance 10 kilohms

MIC 1, MIC 2:

Sensitivity 1 mV, impedance 10 kilohms

### Outputs

AUDIO/PARTY CHAIN OUT L/R:

Voltage 2 V, impedance 600 ohms



## Disc player section

System:

Compact disc and digital audio system

Laser Diode Properties

Emission Duration: Continuous

Laser Output\*: Less than 44.6μW

\* This output is the value measurement at a distance of 200mm from the objective lens surface on the Optical Pick-up Block with 7mm aperture.

## USB section

ψ (USB) port:

Type A, maximum current 1 A

## Supported audio formats (MP3 discs and USB devices only)

Supported bit rate:

MP3 (MPEG1 Audio Layer-3): 32 kbps – 320 kbps, VBR

WMA\*: 32 kbps – 192 kbps, VBR

Sampling frequencies:

MP3 (MPEG1 Audio Layer-3):

32/44.1/48 kHz

WMA\*: 44.1 kHz

\* USB devices only

## Tuner section

FM stereo

FM superheterodyne tuner

Antenna:

FM lead antenna

FM tuner section:

Tuning range:

North American model: 87.5 MHz – 108.0 MHz (100 kHz step)

Other models: 87.5 MHz – 108.0 MHz (50 kHz step)

## BLUETOOTH section

Communication system:

BLUETOOTH Standard version 3.0

Output:

BLUETOOTH Standard Power Class 2

Maximum output power:

< 3.7 dBm

Maximum communication range:

Line of sight approx. 10 m (33 feet)<sup>1)</sup>

Frequency band:

2.4 GHz band (2.4000 GHz – 2.4835 GHz)

Modulation method:

FHSS (Freq Hopping Spread Spectrum)

Compatible BLUETOOTH profiles<sup>2)</sup>:

A2DP (Advanced Audio Distribution Profile)

AVRCP (Audio Video Remote Control Profile)

SPP (Serial Port Profile)

Supported codecs:

SBC (Sub Band Codec)

AAC (Advanced Audio Coding)

LDAC

<sup>1)</sup> The actual range will vary depending on factors such as obstacles between devices, magnetic fields around a microwave oven, static electricity, reception sensitivity, antenna's performance, operating system, software application, etc.

<sup>2)</sup> BLUETOOTH standard profiles indicate the purpose of BLUETOOTH communication between devices.

## NFC section

Operating frequency:

13.56 MHz

## General

Power requirements:

North American model: AC 120 V,  
60 Hz

Other models: AC 120 V – 240 V,  
50/60 Hz

Power consumption:

45 W

Standby power consumption (at the  
Standby Mode):

0.5 W

Dimensions (W/H/D) (Approx.):

290 mm × 600 mm × 265 mm  
(11 1/2 in × 23 5/8 in × 10 1/2 in)

Mass (Approx.):

10 kg (22 lb 1 oz)

Quantity of the system:

1 piece

Supplied accessories:

Remote control (1)

RO3 (size AAA) batteries (2)

FM lead antenna (1)

AC power cord (1)

AC plug adaptor\* (1) (supplied only  
for certain areas)

\* This plug adaptor is not for the use  
in Chile, Paraguay and Uruguay. Use  
this plug adaptor in the countries  
where it is necessary.

Design and specifications are subject to  
change without notice.

---

## License and Trademark Notice

- MPEG Layer-3 audio coding technology and patents licensed from Fraunhofer IIS and Thomson.
- Windows Media is either a registered trademark or trademark of Microsoft Corporation in the United States and/or other countries.
- This product is protected by certain intellectual property rights of Microsoft Corporation. Use or distribution of such technology outside of this product is prohibited without a license from Microsoft or an authorized Microsoft subsidiary.
- The BLUETOOTH® word mark and logos are registered trademarks owned by Bluetooth SIG, Inc. and any use of such marks by Sony Corporation is under license. Other trademarks and trade names are those of their respective owners.
- The N Mark is a trademark or registered trademark of NFC Forum, Inc. in the United States and in other countries.
- Android™ is a trademark of Google Inc.
- Google Play™ is a trademark of Google Inc.
- LDAC™ and LDAC logo are trademarks of Sony Corporation.

- Apple, the Apple logo, iPhone, and iPod touch are trademarks of Apple Inc., registered in the U.S. and other countries. App Store is a service mark of Apple Inc.
- Use of the Made for Apple badge means that an accessory has been designed to connect specifically to the Apple product(s) identified in the badge, and has been certified by the developer to meet Apple performance standards. Apple is not responsible for the operation of this device or its compliance with safety and regulatory standards. Please note that the use of this accessory with iPod or iPhone may affect wireless performance.
- All other trademarks and registered trademarks are of their respective holders. In this manual, ™ and ® marks are not specified.

<http://www.sony.net/>

