

Television

Reference Guide



BRAVIA

Table of Contents

ВАЖНОЕ ПРИМЕЧАНИЕ	3
ВАЖЛИВА ПРИМІТКА	3
ЕСКЕРТУ	3
Safety Information	3
Precautions	5
Parts and Controls	7
Controls and Indicators	7
Using Remote Control	8
Remote Control Parts Description	8
Connection Diagram	10
Installing the TV to the Wall	12
Using the optional Wall-Mount Bracket ...	12
Troubleshooting	13
Troubles and Solutions	13
Specifications	14

Internet Connection and Data Privacy

This product connects to the internet during initial setup as soon as a network is connected in order to confirm internet connection, and later to configure the Home screen. Your IP address is used in these and all other internet connections. If you do not want your IP address be used at all, do not set-up the wireless internet function and do not connect an internet cable. Please refer to the privacy information presented in the set-up screens for further details of internet connections.

Introduction

Thank you for choosing this Sony product.
Before operating the TV, please read this manual thoroughly and retain it for future reference.

Note

- Before operating the TV, please read the "Safety Information" (page 3).
- Images and illustrations used in the Setup Guide and this manual are for reference only and may differ from the actual product.
- The "xx" that appears in the model name corresponds to a numeric digit, related to design, colour or TV system.
- Sales should be performed in accordance with current applicable local regulation. Product which cannot be used anymore should be utilized in accordance with current applicable local regulation.

Attaching the Table-Top Stand to the TV

Refer to the Setup Guide on top of the cushion.

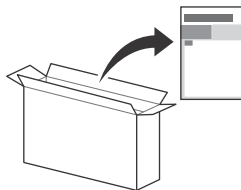

Help

Find more troubleshooting and other useful information directly from your TV. Press **HELP** on the remote control to display a list of topics, or to search by keyword.

Help Guide (Manual)

For more detailed information, select [Help Guide] from the Help menu on your TV. You can also check the Help Guide from your PC or smartphone (information provided on the back cover).

Location of the identification label

Labels for the TV Model No., Production Date (year/month) and Power Supply rating are located on the rear of the TV or package. For models with supplied mains adaptor: Labels for the mains adaptor Model No. and Serial No. are located on the bottom of the mains adaptor.

Дата изготовления указана на изделии и упаковке на этикетке со штрих-кодом в следующем формате: YYYY/MM, где YYYY - год, MM - месяц изготовления.

Дата виготовлення зазначена на виробі та упаковці на етикетці зі штрих-кодом у наступному форматі: YYYY/MM, де YYYY - рік, MM - місяць виготовлення.

Өндіруші: Сони Корпорейшн

Өндіруші мекенжайы: 1-7-1 Конан Минато-ку Токио, 108-0075 Жапония

Словакияда немесе Малайзияда жасалған.

Өндіруші ел өнімде және қорапта көрсетілген.



Кеден одағы жеріндегі шетелден әкелуші: «Сони Электроникс» АҚ, Ресей, 123103, Мәскеу, Карамышевский өтпе көшесі, 6

Қазақстан жеріндегі тұтынушылардың шағым-талаптарын қабылдауға уәкілетті ұйым «Сони Электроникс» АҚ
Қазақстандағы Өкілдігі, 050010, Қазақстан Республикасы, Алматы қ., Достық даңғылы, 117/7 үй

WARNING

TO PREVENT THE SPREAD OF FIRE, KEEP CANDLES OR OTHER OPEN FLAMES AWAY FROM THIS PRODUCT AT ALL TIMES.



Для покупателей в России

Устройство предназначено только для использования в помещениях.

ВАЖНОЕ ПРИМЕЧАНИЕ

Название продукта: Телевизор

Производитель: Сони Корпорейшн, 1-7-1 Конан Минато-ку Токио, 108-0075 Япония
Сделано в Словакии или Малайзии.
Страна производства указана на изделии и упаковке.



Импортер на территории стран Таможенного союза: АО «Сони Электроникс», Россия, 123103, Москва, Карамышевский проезд, 6

Организация, уполномоченная принимать претензии от потребителей на территории Казахстана
АО «Сони Электроникс»
Представительство в Казахстане, 050010, Республика Казахстан, г. Алматы, пр. Достык, дом 117/7

ВАЖЛИВА ПРИМІТКА

Назва виробу: Телевізор

Справжнім Сони Корпорейшн заявляє, що телевізори SONY моделей KD-55XF8096, KD-49XF8096, KD-43XF8096 відповідають Технічному регламенту радіобладнання; повний текст декларації про відповідність доступний на веб-сайті за такою адресою: <http://www.compliance.sony.ua/>.

Радіобладнання може використовуватися на території України без порушення чинних вимог щодо радіочастотного спектру.

Виробник: Сони Корпорейшн, 1-7-1 Конан Мінато-ку Токио, 108-0075 Японія
Вироблено у Словаччині або Малайзії.
Країна виробництва зазначається на виробі та пакуванні.

ЕСКЕРТУ

Онiм атауы: Телевизор

Safety Information

WARNING

Caution

Risk of explosion if the battery is replaced by an incorrect type. Batteries must not be exposed to excessive heat such as sunshine, fire or the like or extremely low air pressure that can result in an explosion or leakage of flammable liquid or gas.

Stability Hazard

The television set may fall, causing serious personal injury or death.

Never place a television set in an unstable location. A television set may fall, causing serious personal injury or death. Many injuries, particularly to children, can be avoided by taking simple precautions such as:

- Using cabinets or stands recommended by the manufacturer of the television set.
- Only using furniture that can safely support the television set.
- Ensuring the television set is not overhanging the edge of the supporting furniture.
- Not placing the television set on tall furniture (for example, cupboards or bookcases) without anchoring both the furniture and the television set to a suitable support.
- Not placing the television set on cloth or other materials that may be located between the television set and supporting furniture.
- Educating children about the dangers of climbing on furniture to reach the television set or its controls.

If your existing television set is being retained and relocated, the same considerations as above should be applied.

Installation/Set-up

Install and use the TV set in accordance with the instructions below in order to avoid any risk of fire, electric shock or damage and/or injuries.

Apparatus connected to the protective earthing of the building installation through the mains connection or through other apparatus with a connection to protective earthing – and to a television distribution system using coaxial cable, may in some circumstances create a fire hazard. Connection to a television distribution system therefore has to be provided through a device providing electrical isolation below a certain frequency range (galvanic isolator, see EN 60728-11).

Installation

- The TV set should be installed near an easily accessible mains socket.
- Place the TV on a stable, level surface to prevent it from falling over and causing personal injury or property damage.
- Install the TV where it cannot be pulled, pushed, or knocked over.
- Install the TV so that the TV's Table-Top Stand does not protrude out from the TV stand (not supplied). If the Table-Top Stand protrudes out from the TV stand, it may cause TV set to topple over, fall down, and cause personal injury or damage to the TV.

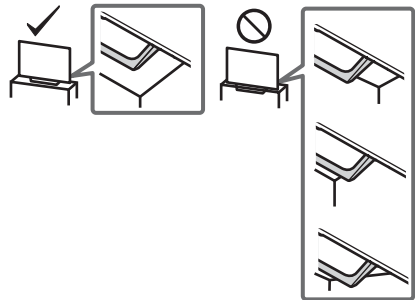

- Only qualified service personnel should carry out wall-mount installations.

- For safety reasons, it is strongly recommended that you use Sony accessories, including:
 - Wall-Mount Bracket SU-WL450
- Be sure to use the screws supplied with the Wall-Mount Bracket to the TV set. The supplied screws are designed as indicated by illustration when measured from the attaching surface of the Wall-Mount Bracket. The diameter and length of the screws differ depending on the Wall-Mount Bracket model. Use of screws other than those supplied may result in internal damage to the TV set or cause it to fall, etc.

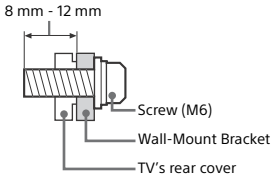

Transporting

- Before transporting the TV set, disconnect all cables.
- Two or three people are needed to transport a large TV set.
- When transporting the TV set by hand, hold it as shown below. Do not put stress on the LCD panel and the frame around the screen.
- When lifting or moving the TV set, hold it firmly from the bottom.

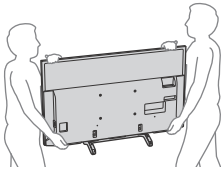

- When transporting the TV set, do not subject it to jolts or excessive vibration.
- When transporting the TV set for repairs or when moving, pack it using the original carton and packing material.

Topple prevention

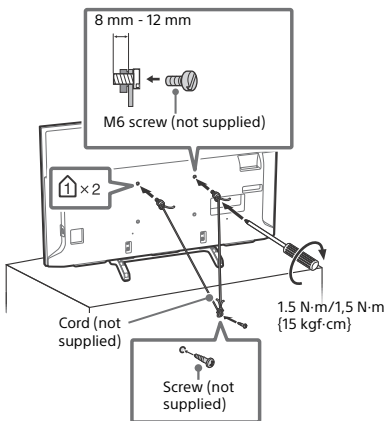

Ventilation

- Never cover the ventilation holes or insert anything in the cabinet.
- Leave space around the TV set as shown below.
- It is strongly recommended that you use a Sony Wall-Mount Bracket in order to provide adequate air circulation.

Installed on the wall

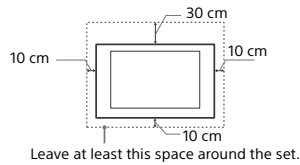

Installed with stand

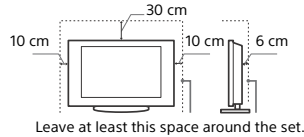

- To ensure proper ventilation and prevent the collection of dirt or dust:
 - Do not lay the TV set flat, install upside down, backwards, or sideways.
 - Do not place the TV set on a shelf, rug, bed or in a closet.
 - Do not cover the TV set with a cloth, such as curtains, or items such as newspapers, etc.
 - Do not install the TV set as shown below.

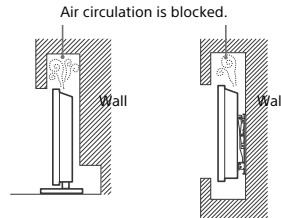

Mains lead

- Handle the mains lead and socket as follows in order to avoid any risk of fire, electric shock or damage and/or injuries:
- Use only mains leads supplied by Sony, not other suppliers.
 - Insert the plug fully into the mains socket.
 - Operate the TV set on a 220 V - 240 V AC supply only.
 - When wiring cables, be sure to unplug the mains lead for your safety and take care not to catch your feet on the cables.
 - Disconnect the mains lead from the mains socket before working on or moving the TV set.
 - Keep the mains lead away from heat sources.
 - Unplug the mains plug and clean it regularly. If the plug is covered with dust and it picks up moisture, its insulation may deteriorate, which could result in a fire.

Note

- Do not use the supplied mains lead on any other equipment.
- Do not pinch, bend, or twist the mains lead excessively. The core conductors may be exposed or broken.
- Do not modify the mains lead.
- Do not put anything heavy on the mains lead.
- Do not pull on the mains lead itself when disconnecting the mains lead.
- Do not connect too many appliances to the same mains socket.
- Do not use a poor fitting mains socket.

NOTE ON MAINS ADAPTOR (models with supplied mains adaptor only)

Warning

To reduce the risk of fire or electric shock, do not expose this apparatus to rain or moisture.
To prevent fire or shock hazard, do not place objects filled with liquids, such as vases, on the apparatus. Do not install this equipment in a confined space, such as a bookshelf or similar unit.

- Please ensure that the mains socket is installed near the equipment and shall be easily accessible.
- Be sure to use the supplied mains adaptor and mains lead.
- Do not use any other mains adaptor. It may cause a malfunction.
- Connect the mains adaptor to an easily accessible mains socket.
- Do not coil the mains lead around the mains adaptor. The core wire may be cut and/or it may cause a malfunction of the media receiver.



- Do not touch the mains adaptor with wet hands.
- If you notice an abnormality in the mains adaptor, disconnect it from the mains socket immediately.
- The set is not disconnected from the mains source as long as it is connected to the mains socket, even if the set itself has been turned off.
- As the mains adaptor will become warm when it is used for a long time, you may feel hot when touching it by hand.

Prohibited Usage

Do not install/use the TV set in locations, environments or situations such as those listed below, or the TV set may malfunction and cause a fire, electric shock, damage and/or injuries.

Locations:

- Outdoors (in direct sunlight), at the seashore, on a ship or other vessel, inside a vehicle, in medical institutions, unstable locations, near water, rain, moisture or smoke.

Environments:

- Places that are hot, humid, or excessively dusty; where insects may enter; where it might be exposed to mechanical vibration, near flammable objects (candles, etc.). The TV set shall not be exposed to dripping or splashing and no objects filled with liquids, such as vases, shall be placed on the TV.

Situations:

- Use when your hands are wet, with the cabinet removed, or with attachments not recommended by the manufacturer. Disconnect the TV set from mains socket and aerial during lightning storms.
- Install the TV so that it sticks out into an open space. Injury or damage from a person or object bumping into the TV may result.



- Place the TV in a humid or dusty space, or in a room with oily smoke or steam (near cooking tables or humidifiers). Fire, electric shock, or warping may result.



- Install the TV in places subject to extreme temperature such as in direct sunlight, near a radiator or a heating vent. The TV may overheat in such condition which can cause deformation of the enclosure and/or TV malfunction.



- If the TV is placed in the changing room of a public bath or hot spring, the TV may be damaged by airborne sulfur, etc.



- For best picture quality, do not expose the screen to direct illumination or sunlight.
- Avoid moving the TV from a cold area to a warm area. Sudden room temperature changes may cause moisture condensation. This may cause the TV to show poor picture and/or poor colour. Should this occur, allow moisture to evaporate completely before powering the TV on.

Broken pieces:

- Do not throw anything at the TV set. The screen glass may break by the impact and cause serious injury.
- If the surface of the TV set cracks, do not touch it until you have unplugged the mains lead. Otherwise this may cause an electric shock.

When not in use

- If you will not be using the TV set for several days, the TV set should be disconnected from the mains for environmental and safety reasons.
- As the TV set is not disconnected from the mains when the TV set is just turned off, pull the plug from the mains socket to disconnect the TV set completely.
- Some TV sets may have features that require the TV set to be left in standby to work correctly.

For children

- Do not allow children to climb on the TV set.
- Keep small accessories out of the reach of children, so that they are not mistakenly swallowed.

If the following problems occur...

Turn off the TV set and unplug the mains lead immediately if any of the following problems occur.

Ask your dealer or Sony service centre to have it checked by qualified service personnel.

When:

- Mains lead is damaged.
- Poor fitting of mains socket.
- TV set is damaged by being dropped, hit or having something thrown at it.
- Any liquid or solid object falls through openings in the cabinet.

About LCD TV Temperature

When the LCD TV is used for an extended period, the panel surrounds become warm. You may feel hot when touching there by the hand.

Precautions

Viewing the TV

- View the TV in moderate light, as viewing the TV in poor light or during long period of time, strains your eyes.
- When using headphones, adjust the volume so as to avoid excessive levels, as hearing damage may result.

LCD Screen

- Although the LCD screen is made with high-precision technology and 99.99 % or more of the pixels are effective, black dots may appear or bright points of light (red, blue, or green) may appear constantly on the LCD screen. This is a structural property of the LCD screen and is not a malfunction.
- Do not push or scratch the front filter, or place objects on top of this TV set. The image may be uneven or the LCD screen may be damaged.
- If this TV set is used in a cold place, a smear may occur in the picture or the picture may become dark. This does not indicate a failure. These phenomena disappear as the temperature rises.
- Ghosting may occur when still pictures are displayed continuously. It may disappear after a few moments.
- The screen and cabinet get warm when this TV set is in use. This is not a malfunction.
- The LCD screen contains a small amount of liquid crystal. Follow your local ordinances and regulations for disposal.

Handling and cleaning the screen surface/ cabinet of the TV set

Be sure to unplug the mains lead connected to the TV set from mains socket before cleaning.

To avoid material degradation or screen coating degradation, observe the following precautions.

- To remove dust from the screen surface/cabinet, wipe gently with a soft cloth. If dust is persistent, wipe with a soft cloth slightly moistened with a diluted mild detergent solution.
- Never spray water or detergent directly on the TV set. It may drip to the bottom of the screen or exterior parts and enter the TV set, and may cause damage to the TV set.
- Never use any type of abrasive pad, alkaline/acid cleaner, scouring powder, or volatile solvent, such as alcohol, benzene, thinner or insecticide. Using such materials or maintaining prolonged contact with rubber or vinyl materials may result in damage to the screen surface and cabinet material.
- Do not touch the TV if your hand is covered in any chemical substance such as hand cream or sunblock.
- Periodic vacuuming of the ventilation openings is recommended to ensure proper ventilation.
- When adjusting the angle of the TV set, move it slowly so as to prevent the TV set from moving or slipping off from its table stand.



Optional Equipment

- Keep optional components or any equipment emitting electromagnetic radiation away from the TV set. Otherwise picture distortion and/or noisy sound may occur.
- This equipment has been tested and found to comply with the limits set out in the EMC Directive using a connection signal cable shorter than 3 meters.
- This equipment has been tested and found to comply with the limits set out in the EMC Directive using a RF cable shorter than 30 meters for terrestrial/satellite/CATV terminal.

Recommendation of F type plug

Projection of the inner wire from the connection part must be less than 1.5 mm.

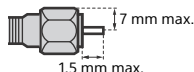

(Reference drawing of the F type plug)

Wireless Function of the unit

- Do not operate this unit near medical equipment (pacemaker, etc.), as this may result in the malfunction of the medical equipment.
- Although this unit transmits/receives scrambled signals, be careful of unauthorised interception. We cannot be responsible for any trouble as a result.
- This equipment should be installed and operated keeping a separation distance of 20 cm or more between the antenna of this device and a person's body.

Caution about handling the remote control

- Observe the correct polarity when inserting batteries.
- Do not use different types of batteries together or mix old and new batteries.
- Dispose of batteries in an environmentally friendly way. Certain regions may regulate the disposal of batteries. Please consult your local authority.
- Handle the remote control with care. Do not drop or step on it, or spill liquid of any kind onto it.
- Do not place the remote control in a location near a heat source, a place subject to direct sunlight, or a damp room.

Утилизация телевизора



Утилизация отслужившего электрического и электронного оборудования (директива применима в странах Евросоюза и других странах, где действуют системы раздельного сбора отходов)



Утилизация использованных элементов питания (Директива применима в странах Евросоюза и других странах, где действуют системы раздельного сбора отходов)

Утилізація телевізора



Утилізація старого електричного та електронного обладнання (застосовується в Європейському союзі та інших країнах із системами роздільного збирання сміття)



Утилізація використаних батарей (застосовно в Європейському союзі та інших країнах, у яких діють системи роздільного збирання сміття)

Теледидар құрылғысын лақтыру



Қызмет мерзімі біткен электрлік және электрондық жабдықты залалсыз жою (бағыттама қалдықтарды бөлек жинау жүйелері жұмыс істейтін Еуропа Одағы мен басқа елдерде қолданылады)



Пайдаланылған аккумуляторларды залалсыз жою (қалдықтарды бөлек жинау жүйелері жұмыс істейтін Еуропа Одағы мен басқа елдерде қолданылады)

Parts and Controls

Controls and Indicators

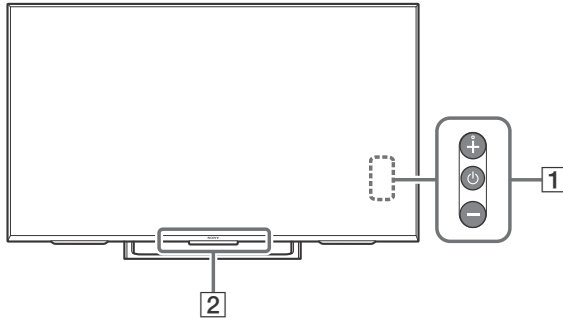

1 (Power) /+/-

When the TV is off,

Press  to power on.

When the TV is on,

Press and hold  to power off.

Press  repeatedly to change the function, then press + or - button to:

- Adjust the volume.
- Select the channel.
- Select the input source of TV.

2 **Remote Control sensor* / Light sensor* / Illumination LED**

The illumination LED lights up or blinks according to the status of the TV.

For more information, refer to the Help Guide.





* Do not place anything near the sensor.

Using Remote Control

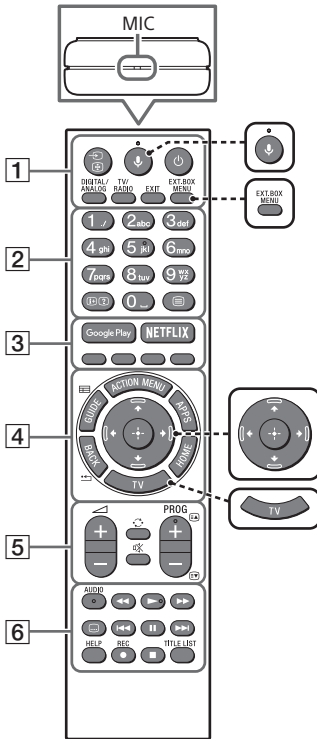
Remote Control Parts Description

The remote control shape, location, availability and function of remote control buttons may vary depending on your region/country/TV model.



-  **Ⓜ (Microphone)**
Use Voice Search. (e.g., Search various content by voice.)
-  **EXT.BOX MENU**
Display the External Box (cable/satellite box) menu only if HDMI CEC compatible device is connected.
-  **⬆/⬇/⬅/➡/⬆ (Navigation D-Pad)**
On screen menu navigation and selection.
-  **TV**
Switch to a TV channel or input and display the TV Menu Bar.

1  **(Input select/Text hold)**
In TV mode: Display and select the input source.
In Text mode: Hold the current page.

 **(TV standby)**
Turn on or turn off the TV (standby mode).

DIGITAL/ANALOG
Switch between digital and analogue mode.

TV/RADIO
Switch between TV or RADIO broadcasts.

EXIT
Return to the previous screen or exit from the menu. When an Interactive Application service is available, press to exit from the service.

2 **Number buttons**

 **(Info/Text reveal)**
Display information.

 **(Text)**
Display text information.

3 Google Play

Access the "Google Play" online service.

NETFLIX (Only on limited region/ country/TV model)

Access the "NETFLIX" online service.

Colour buttons

Execute corresponding function at that time.

4 ACTION MENU

Display a list of contextual functions.

GUIDE/

Display the digital programme guide.

APPS

Access various services and applications.

BACK/

Return to the previous screen.

HOME

Display the TV Home Menu.

5 +/- (Volume)

Adjust the volume.

(Jump)



Jump back and forth between two channels or inputs. The TV alternates between the current channel or input and the last channel or input that was selected.

(Muting)

Mute the sound. Press again to restore the sound.

PROG +/-/

In TV mode: Select the channel.

In Text mode: Select the next () or previous () page.

6 AUDIO

Change the language for the programme currently being viewed.

Operate media contents on the TV and connected BRAVIA Sync-compatible device.

(Subtitle setting)

Turn subtitles on or off (when the feature is available).

HELP

Display the Help menu. Help Guide can be accessed from here.

REC

Record the current programme with the USB HDD recording function.

TITLE LIST

Display the Title list.

Connection Diagram

For more information on connections, refer to the Help Guide by pressing **HELP** on the remote control.

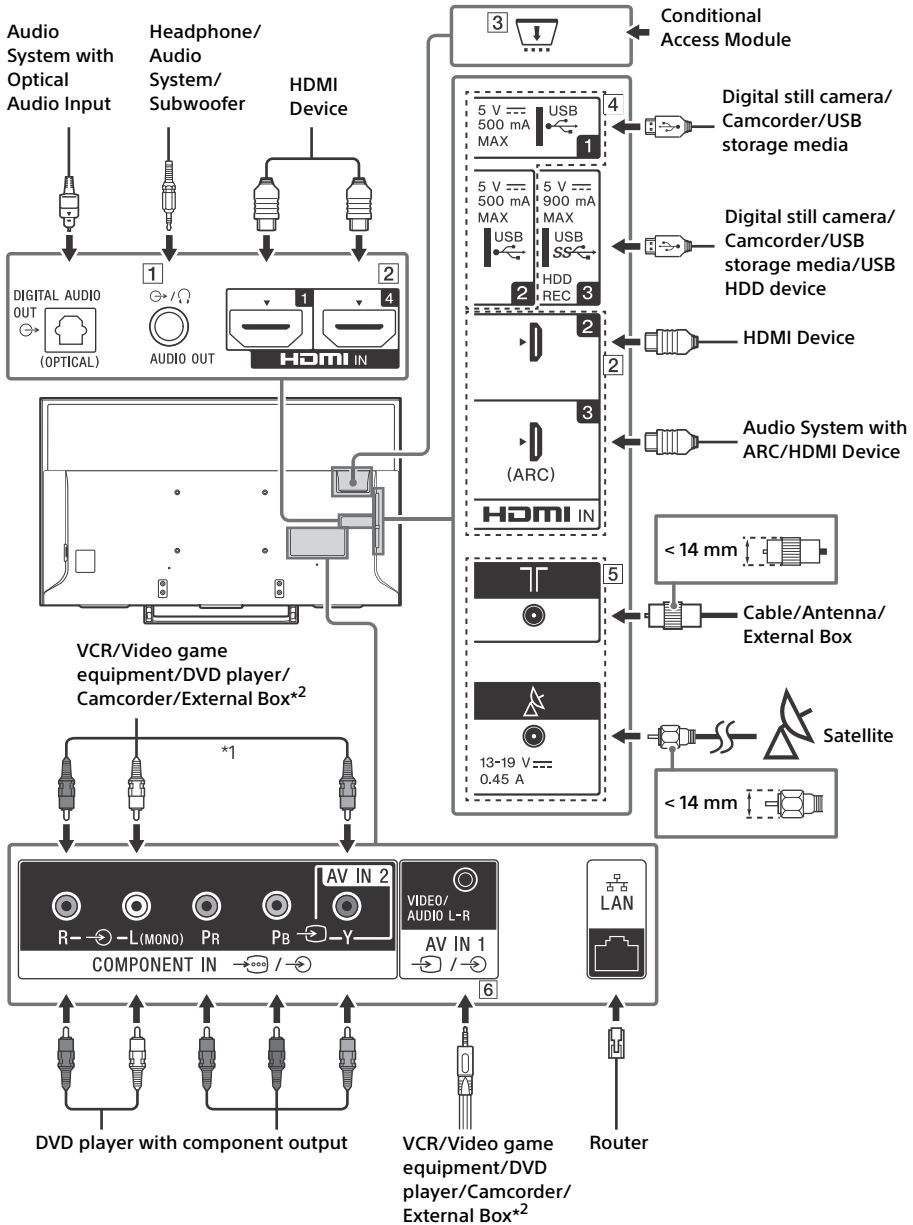

1 AUDIO OUT

- Supports 3-pole stereo mini jack only.
- To listen to the TV's sound through the connected equipment, press **HOME**. Select [Settings] → [Sound] → [Headphone/Audio out] and then select the desired item.

2 HDMI IN 1/2/3/4

- HDMI interface can transfer the digital video and audio on a single cable.

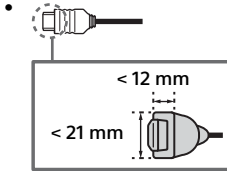

• HDMI IN 2/3

To enjoy high quality 4K 50p/60p contents, connect a Premium High Speed HDMI cable to the HDMI IN 2/3 and set the [HDMI signal format] to [Enhanced format].

For details of supported formats, refer to the "Specifications" in this manual (page 14-16).

• HDMI IN 3 ARC (Audio Return Channel)

Connect your audio system to the HDMI IN 3 to route TV audio to your audio system. An audio system that supports HDMI ARC can send video to the TV, and receive audio from the TV via the same HDMI cable. If your audio system does not support HDMI ARC, an additional connection with DIGITAL AUDIO OUT (OPTICAL) is necessary.

3 CAM (Conditional Access Module)

- Provides access to pay TV services. For details, refer to the instruction manual supplied with your CAM.
- Do not insert the smart card directly into the TV CAM slot. It must be fitted into the Conditional Access Module provided by your authorised dealer.
- CAM is not supported in some countries/ areas. Check with your authorised dealer.
- A CAM message may appear when you switch to a digital programme after using the Internet video.

4 USB 1/2, USB 3 (HDD REC)*3

- Connecting a large USB device may interfere with other connected devices beside it.
- When connecting a large USB device, connect to the USB 1 port.
- Connect a USB HDD device to the USB 3 port (blue).

5 (RF input), (Satellite input)

- Connections for terrestrial/cable and satellite.

6 AV IN 1

- For a composite connection, use an Analogue Extension Cable (not supplied).

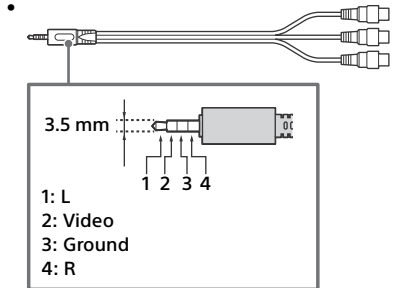

*1 When connecting mono equipment, connect to the L (MONO) audio jack (socket).

*2 For an external device which has only SCART AV OUT, use a SCART-RCA adaptor and Analogue Extension Cable.

*3 Only on limited region/country/TV model.

Installing the TV to the Wall

Using the optional Wall-Mount Bracket

This TV's instruction manual only provides the steps to prepare the TV for Wall-Mount installation before it is installed on the wall.

To Customers:

For product protection and safety reasons, Sony strongly recommends that installation of your TV be performed by Sony dealers or licensed contractors. Do not attempt to install it yourself.

To Sony Dealers and Contractors:

Provide full attention to safety during the installation, periodic maintenance and examination of this product.

Sufficient expertise is required for installing this product, especially to determine the strength of the wall for withstanding the TV's weight. Be sure to entrust the attachment of this product to the wall to Sony dealers or licensed contractors and pay adequate attention to safety during the installation. Sony is not liable for any damage or injury caused by mishandling or improper installation.

Use the Wall-Mount Bracket SU-WL450 (not supplied) to install the TV to the wall. When installing the Wall-Mount Bracket, also refer to the Operating Instructions and Installation Guide supplied with the Wall-Mount Bracket.

Note

- Be sure to store the removed screws in a safe place, keeping them away from children.
- Place the TV with its screen facing down on a level and stable surface covered with a thick and soft cloth when removing the Table-Top Stand from the TV to prevent damaging the surface of the LCD display.



For instructions on Wall-Mount Bracket installation, see the Installation Information (Wall-Mount Bracket) on the product page for your TV model.

www.sony.eu/support/

To detach the Table-Top Stand from the TV

KD-55XF80xx only

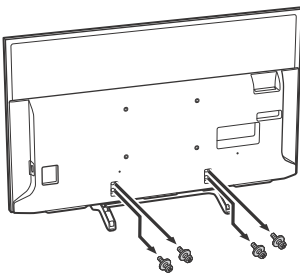

KD-49/43XF80xx only

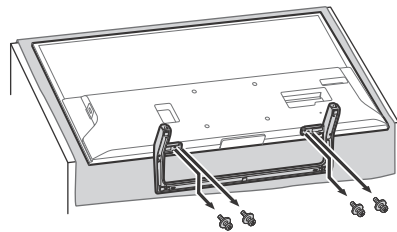

Troubleshooting

General troubleshooting for issues like: black screen, no sound, frozen picture, TV does not respond, or network is lost, do the following steps.

- 1 Restart your TV by pressing the power button on the remote control until a message appears. The TV will restart. If the TV does not recover, try unplugging the TV from the mains lead for two minutes and then plug it in again.
- 2 Refer to the Help menu by pressing **HELP** on the remote control.
- 3 Connect your TV to the Internet and perform a software update.
- 4 Visit Sony support website (information provided on the back cover).

When [A new TV system software update is available...] message is displayed.

Sony strongly recommends you to update the TV software by selecting [Update Now]. These software updates improve your TV performance or add new features.

The following screen with [Updating...] will appear and the illumination LED flashes white while software is updating.

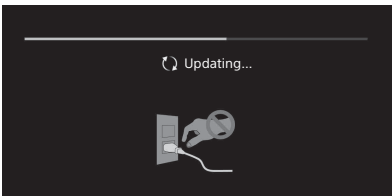

Do not unplug the mains lead during the software update. If you do, the software update may not finish completely, and it may cause a software malfunction. Software updates can take up to 15 minutes.

When you plug in the TV, the TV may not be able to turn on for a while even if you press the power button on the remote control or the TV.

It takes time to initialize the system. Wait for about one minute, then operate it again.

Troubles and Solutions

When the illumination LED is flashing in red.

- Count how many times it flashes (interval time is three seconds).
Reboot the TV by disconnecting the mains lead for two minutes, then turn on the TV.
If the problem persists, disconnect the mains lead, and contact your dealer or Sony service centre with the number of times the illumination LED flashes.

Terrestrial/cable service cannot be received.

- Check the antenna (aerial)/cable connection and booster settings.
- Select terrestrial/cable service by pressing **DIGITAL/ANALOG** on the remote control. If the broadcasting service is not displayed, press **TV** and then press **DIGITAL/ANALOG**.
- Terrestrial signal might be suppressed if there is a strong signal supplied nearby.
- After moving to a new house or trying to receive new services, attempt a service search by selecting [Digital Tuning].

Satellite service cannot be received.

- Check the satellite cable connection.
- When [No signal. LNB overload detected...] message is displayed, unplug the mains lead. Then, ensure the satellite cable is not damaged and the satellite signal line is not short-circuited in the satellite connector.

The remote control does not function.

- Replace the batteries.

The EXT.BOX MENU button on the remote control does not work.

- Connect HDMI CEC compatible device and change to that input.

The parental lock for broadcast password has been forgotten.

- Enter 9999 for the PIN code and select [Change PIN Code].

The TV surrounds become warm.

- When the TV is used for an extended period, the TV surrounds become warm. You may feel hot when touching there by the hand.

Specifications

System

Panel system

LCD (Liquid Crystal Display) Panel, LED Backlight

TV system

Depending on your country/area selection/TV model

Analogue: B/G, D/K, I

Digital: DVB-T/DVB-C

DVB-T2*

Satellite*: DVB-S/DVB-S2

Colour system

PAL/SECAM/NTSC3.58 (Video only)/NTSC4.43/ (Video only)

Channel coverage

Depending on your country/area selection/TV model

Analogue: UHF/VHF/Cable

Digital: UHF/VHF/Cable

Satellite*: IF Frequency 950-2,150 MHz

Sound output

10 W + 10 W

Wireless technology

Protocol IEEE802.11ac/a/b/g/n

(IEEE802.11ac may not be available depending on countries/regions.)

Bluetooth Version 4.1

Частотні діапазони

Бездротова LAN (IEEE802.11ac/a/b/g/n)	
Діапазон частот	Вихідна потужність
2400-2483,5 МГц	< 20,0 dBm
5150-5350 МГц	< 20,0 dBm
5470-5850 МГц	< 20,0 dBm

Bluetooth	
Діапазон частот	Вихідна потужність
2400-2483,5 МГц	< 10,0 dBm

RMF-TX310E

Bluetooth	
Діапазон частот	Вихідна потужність
2400-2483,5 МГц	< 10,0 dBm

Версія програмного забезпечення

Телевізор: PKG . ____ . ____ EUA

Натисніть **HELP** на пристрої дистанційного керування, щоб дізнатися версію програмного забезпечення.

Пристрій дистанційного керування: ____ . ____ . ____

Натисніть **HOME**, потім перейдіть до [Налаштування] → [Голосове дистанційне керування] → [Версія ПЗ].

Будь-які оновлення програмного забезпечення/мікропрограми для цього обладнання/пристроїв/компонентів в жодному разі не будуть порушувати відповідність Технічному регламенту радіообладнання.

* Not all the TV sets have DVB-T2 or DVB-S/S2 technology or satellite antenna terminal.

Input/Output jacks

Antenna (aerial)/cable

75 ohm external terminal for VHF/UHF

Satellite antenna

Female F Type Connector, 75 ohm.

DiSEqC 1.0, LNB 13 V/18 V & 22 kHz tone, Single Cable Distribution EN50494.

AV IN 1

Video/Audio input (mini jack)

COMPONENT IN

YPbPr (Component Video): 1080p (50, 60 Hz), 1080i (50, 60 Hz), 720p (50, 60 Hz), 576p, 576i, 480p, 480i

Audio input (phono jacks)

AV IN 2

Video input (common phono pin with Y input)

HDMI IN 1/2/3/4 (support 4K resolution, HDCP 2.3-compatible)

Video:

4096 × 2160p (50, 60 Hz)^{*1*}, 4096 × 2160p (24 Hz)^{*1}, 3840 × 2160p (50, 60 Hz)^{*2}, 3840 × 2160p (24, 25, 30 Hz), 1080p (30, 50, 60 Hz), 1080/24p, 1080i (50, 60 Hz), 720p (30, 50, 60 Hz), 720/24p, 576p, 576i, 480p, 480i, PC Formats^{*3}

*1 When 4096 × 2160p is input and [Wide mode] is set to [Normal], the resolution is displayed as 3840 × 2160p. To display 4096 × 2160p, set [Wide mode] setting to [Full 1] or [Full 2].

*2 HDMI IN 2/3 only. To support 18 Gbps, set [HDMI signal format] to [Enhanced format].

*3 Refer to the Help Guide for details.

Audio:

5.1 channel linear PCM: 32/44.1/48/88.2/96/176.4/192 kHz 16/20/24 bits, Dolby Digital, Dolby Digital Plus and DTS

ARC (Audio Return Channel) (HDMI IN 3 only)
(Two channel linear PCM: 48 kHz 16 bits, Dolby Digital, Dolby Digital Plus, DTS)

↻ DIGITAL AUDIO OUT (OPTICAL)

Digital optical jack (Two channel linear PCM:
48 kHz 16 bits, Dolby Digital, DTS)

AUDIO OUT ↻ ↻ (Stereo mini jack)

Headphone, Audio output, Subwoofer

↻ 1, ↻ 2, **SS** ↻ 3 (HDD REC)*¹

USB device port (**SS** ↻ 3 USB HDD device for
REC feature)

USB port 1 and 2 support High Speed USB
(USB 2.0).

USB port 3 supports Super Speed USB (USB 3.1
Gen 1).



CAM (Conditional Access Module) slot

LAN

10BASE-T/100BASE-TX connector (Depending on
the operating environment of the network,
connection speed may differ. 10BASE-T/
100BASE-TX communication rate and
communication quality are not guaranteed for
this TV.)

⊖ ⊕ DC IN 19.5 V (models with supplied mains
adaptor only)

Mains adaptor input

Others

Optional accessories

Wall-Mount Bracket: SU-WL450

Условия хранения:

Товары сохраняют в упакованном виде в
темных, сухих, чистых, хорошо вентилируемых
помещениях, изолированных от мест
хранения кислот и щелочей.

Температура хранения*: от -20 °C до +60 °C.

Относительная влажность хранения*: < 80 %
(без конденсации).

* Примечание: максимальные значения для
обоих параметров не могут быть достигнуты
одновременно.

Рабочая температура: от 0 °C до 40 °C. Рабочая
относительная влажность: 10 % – 80 % (без
конденсации).

Умови зберігання:

Продукцію зберігають в упакованому виді в
темних, сухих, чистих, добре вентиляваних
приміщеннях, ізольованих від місць зберігання
кислот і лугів. Температура зберігання*: від
-20 °C до +60 °C. Відносна вологість
зберігання*: < 80 % (без конденсації).

* Примітка: неможливо отримати максимальні
значення для обох параметрів одночасно.

Робоча температура: від 0 °C до 40 °C. Робоча
відносна вологість: 10 % – 80 % (без
конденсації).

Сақтау шарты:

Өнімдерді қараңғы, құрғақ, таза, жақсы
желдетілетін қышқылдар мен сілтілік металдар
сақталған орыннан оқшауланған бумада сақтау
қажет. Сақтау температурасы*: -20 °C мен +60 °C
аралығы. Сақтау ылғалдылығы*: < 80 % салыст.
ылғалдылық (конденсациясыз).

* Ескерту: Екі параметрдің ең үлкен мәндеріне бір
уақытта жету мүмкін емес.

Жұмыс температурасы: 0 °C мен 40 °C аралығы.

Жұмыс ылғалдылығы: 10 % – 80 % салыст.

ылғалдылық (конденсациясыз).

Power, Product Fiche and others

Power requirements

Except models with supplied mains adaptor

220 V - 240 V AC, 50 Hz

Models with supplied mains adaptor only

19.5 V DC with mains adaptor

Rating: Input 220 V - 240 V AC, 50 Hz

Energy Efficiency Class

KD-55XF80xx: A

KD-49XF80xx: A

KD-43XF80xx: A

Screen size (measured diagonally) (Approx.)

KD-55XF80xx: 138.8 cm / 55 inches

KD-49XF80xx: 123.2 cm / 49 inches

KD-43XF80xx: 108.0 cm / 43 inches

Удельная потребляемая мощность в режиме

[Стандартный]:

KD-55XF80xx: 11,6 мВт/см²

KD-49XF80xx: 13,6 мВт/см²

KD-43XF80xx: 13,5 мВт/см²

Power consumption

in [Standard] mode

KD-55XF80xx: 95 W

KD-49XF80xx: 85 W

KD-43XF80xx: 67 W

in [Vivid] mode

KD-55XF8096: 166 W

KD-49XF8096: 143 W

KD-43XF8096: 120 W

Average annual energy consumption*2

KD-55XF80xx: 132 kWh

KD-49XF80xx: 118 kWh

KD-43XF80xx: 93 kWh

Standby power consumption*3*4

0.50 W (13 W in software/EPG update mode)

Display resolution

3,840 dots (horizontal) × 2,160 lines (vertical)

Output Rating

USB 1/2

5 V $\overline{\text{---}}$, 500 mA MAX

USB 3

5 V $\overline{\text{---}}$, 900 mA MAX

Dimensions (Approx.) (w × h × d)

with Table-Top Stand

KD-55XF80xx: 123.2 × 77.2 × 25.2 cm

KD-49XF80xx: 109.6 × 69.1 × 25.2 cm

KD-43XF80xx: 96.4 × 61.7 × 24.2 cm

without Table-Top Stand

KD-55XF80xx: 123.2 × 71.6 × 5.7 cm

KD-49XF80xx: 109.6 × 64.0 × 5.7 cm

KD-43XF80xx: 96.4 × 56.7 × 5.7 cm

Mass (Approx.)

with Table-Top Stand

KD-55XF80xx: 18.6 kg

KD-49XF80xx: 12.9 kg

KD-43XF80xx: 10.8 kg

without Table-Top Stand

KD-55XF80xx: 17.6 kg

KD-49XF80xx: 12.2 kg

KD-43XF80xx: 10.1 kg

*1 Only on limited region/country/TV model.

*2 Energy consumption per year, based on the power consumption of the television operating 4 hours per day for 365 days. The actual energy consumption will depend on how the television is used.

*3 Specified standby power is reached after the TV finishes necessary internal processes.

*4 Standby power consumption will increase when your TV is connected to the network.

Note

- Do not remove the dummy card from TV CAM (Conditional Access Module) slot other than to insert a smart card fitted in CAM.
- Optional accessories availability depends on countries/region/TV model/stock.
- Design and specifications are subject to change without notice.

Notes on Digital TV function

- Digital TV (DVB terrestrial, satellite and cable), interactive services and network functions may not be available in all countries or areas. Some functions might not be enabled or might not operate correctly with some providers and network environments. Some TV service providers may charge a fee for their services.
- This TV supports digital broadcasting using MPEG-2, H.264/MPEG-4 AVC and H.265/HEVC codecs, but compatibility with all operator/service signals, which may change over time, cannot be guaranteed.

Trademark information

- The terms HDMI and HDMI High-Definition Multimedia Interface, and the HDMI Logo are trademarks or registered trademarks of HDMI Licensing Administrator, Inc. in the United States and other countries.
- Manufactured under license from Dolby Laboratories. Dolby, Dolby Audio, and the double-D symbol are trademarks of Dolby Laboratories.
- "BRAVIA", BRAVIA and BRAVIA Sync are trademarks or registered marks of Sony Corporation.
- Gracenote, the Gracenote logo and logotype, "Powered by Gracenote" logo are either registered trademarks or trademarks of Gracenote, Inc. in the United States and/or other countries.
- Vewd® Core. Copyright 1995-2017 Vewd Software AS. All rights reserved.
- Google, Android TV, Google Play, Chromecast built-in, YouTube and other related marks and logos are trademarks of Google LLC.
- Wi-Fi®, Wi-Fi Alliance®, Wi-Fi Direct® and Miracast® are registered trademarks of Wi-Fi Alliance.
- Wi-Fi Protected Setup™ is a trademark of Wi-Fi Alliance.
- The Wi-Fi CERTIFIED™ Logo is a certification mark of Wi-Fi Alliance.

- For DTS patents, see <http://patents.dts.com>. Manufactured under license from DTS, Inc. DTS, the Symbol, & DTS and the Symbol together are registered trademarks, and DTS Digital Surround is a trademark of DTS, Inc. © DTS, Inc. All Rights Reserved.
- The Bluetooth® word mark and logos are registered trademarks owned by the Bluetooth SIG, Inc. and any use of such marks by Sony Corporation is under license. Other trademarks and trade names are those of their respective owners.
- Netflix is a registered trademark of Netflix, Inc.
- DiSEqC™ is a trademark of EUTELSAT. This TV supports DiSEqC 1.0. This TV is not intended for controlling motorized antennas.
- TUXERA is a registered trademark of Tuxera Inc. in the US and other countries.
- USB-IF SuperSpeed USB Trident logo is a registered trademark of USB Implementers Forum, Inc. 
- All other trademarks are the property of their respective owners.



4K

Actual resolution: 3840 x 2160 pixels



Справочное руководство
Довідка
Көмекші нұсқаулық

http://rd1.sony.net/help/tv/faep1/h_aep/



Для получения полезной информации о продукции Сони
Для отримання корисної інформації щодо виробів компанії Sony
Sony өнімдерінің пайдалы ақпараттары
Sony mahsulotlari haqida foydali ma'lumotlar uchun

www.sony.eu/support

<http://www.sony.net/>

© 2018 Sony Corporation