

SONY®

Sound Bar

Operating Instructions



HT-S350

WARNING

Do not install the Sound Bar in a confined space, such as a bookcase or built-in cabinet.

To reduce the risk of fire, do not cover the ventilation opening of the Sound Bar with newspapers, tablecloths, curtains, etc.

Do not expose the Sound Bar to naked flame sources (for example, lighted candles).

To reduce the risk of fire or electric shock, do not expose this Sound Bar to dripping or splashing, and do not place objects filled with liquids, such as vases, on the Sound Bar.

The Sound Bar is not disconnected from the mains as long as it is connected to the AC outlet, even if the Sound Bar itself has been turned off.

As the main plug is used to disconnect the Sound Bar from the mains, connect the Sound Bar to an easily accessible AC outlet. Should you notice an abnormality in the Sound Bar, disconnect the main plug from the AC outlet immediately.

CAUTION

Risk of explosion if the battery is replaced by an incorrect type. Do not expose batteries or appliances with battery-installed to excessive heat, such as sunshine and fire.

Indoor use only.

Recommended cables

Properly shielded and grounded cables and connectors must be used for connection to host computers and/or peripherals.

For the Bar Speaker

The nameplate is located on the bottom of the Bar Speaker.

For the customers in Europe

Notice for customers: the following information is only applicable to equipment sold in countries applying EU directives.

This product has been manufactured by or on behalf of Sony Corporation. EU Importer: Sony Europe B.V. Inquiries to the EU Importer or related to product compliance in Europe should be sent to the manufacturer's authorized representative, Sony Belgium, *bijkantoor van Sony Europe B.V.*, Da Vincilaan 7-D1, 1930 Zaventem, Belgium.



Hereby, Sony Corporation declares that this equipment is in compliance with Directive 2014/53/EU.

The full text of the EU declaration of conformity is available at the following internet address:

<http://www.compliance.sony.de/>

This equipment has been tested and found to comply with the limits set out in the EMC regulation using a connection cable shorter than 3 meters.



Disposal of waste batteries and electrical and electronic equipment (applicable in the European Union

and other countries with separate collection systems)

This symbol on the product, the battery or on the packaging indicates that the product and the battery shall not be treated as household waste. On certain batteries this symbol might be used in combination with a chemical symbol.

The chemical symbol for lead (Pb) is added if the battery contains more than 0.004% lead. By ensuring that these products and batteries are disposed of correctly, you will help to prevent potentially negative consequences for the environment and human health which could be caused by inappropriate waste handling. The recycling of the materials will help to conserve natural resources. In case of products that for safety, performance or data integrity reasons require a permanent connection with an incorporated battery, this battery should be replaced by qualified service staff only. To ensure that the battery and the electrical and electronic equipment will be treated properly, hand over these products at end-of-life to the appropriate collection point for the recycling of electrical and electronic equipment. For all other batteries, please view the section on how to remove the battery from the product safely. Hand the battery over to the appropriate collection point for the recycling of waste batteries. For more detailed information about recycling of this product or battery, please contact your local Civic Office, your household waste disposal service or the shop where you purchased the product or battery.

For the customers in Australia and India



Disposal of old electrical & electronic equipment (applicable in the European Union and other countries with separate

collection systems)

For the customers in Australia or New Zealand

It should be installed and operated with at least 20 cm and more between the radiator and person's body (excluding extremities: hands, wrists, feet and ankles).

This equipment has been tested and found to comply with the limits set out in the EMC regulation using a connection cable shorter than 3 meters.

Table of Contents

About These Operating Instructions	4
What's in the Box	5
What You Can Do with the Sound Bar	6
Guide to Parts and Controls	7

Connecting a TV

Connecting a TV with an HDMI Cable	→	Startup Guide (separate document)	
Connecting Sony TV with the BLUETOOTH Function Wirelessly			14
Mounting the Bar Speaker on a Wall			16
When the TV Remote Control does not Work			18

Listening to the Sound

Listening to a TV and Other Devices	19
Adjusting the Sound	20

Listening to Music/Sound with the BLUETOOTH® Function

Listening to Music from a Mobile Device	22
Turning the Sound Bar On by Operating the BLUETOOTH Device	24
Turning the BLUETOOTH Function Off	24

Using the Various Functions

Performing the Wireless Connection of the Subwoofer (SECURE LINK)	25
Using the Control for HDMI Function	26

Using the "BRAVIA" Sync Function	27
Notes on HDMI Connections	28
Saving Power Consumption	28

Troubleshooting

Troubleshooting	29
Resetting the Sound Bar	34

Additional Information

Specifications	35
Supported Input Audio Formats (TV Input)	36
On BLUETOOTH Communication	37
Precautions	38

About These Operating Instructions

- The instructions in these Operating Instructions describe the controls on the remote control.
- Some illustrations are presented as conceptual drawings, and may be different from the actual products.
- The default settings are underlined on each feature description.
Example: Control for HDMI function on

What's in the Box

- Bar Speaker (1)

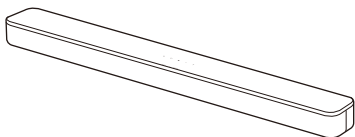

- Subwoofer (1)

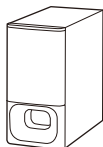

- Remote control (1)

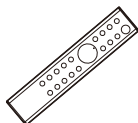

- R03 (size AAA) battery (2)



- Optical digital cable (1)

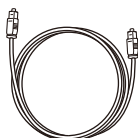

- WALL MOUNT TEMPLATE (1)



- Startup Guide



- Operating Instructions

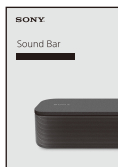

What You Can Do with the Sound Bar

"Listening to a TV and Other Devices" (page 19)



Blu-ray Disc™ player, cable box, satellite box, etc.

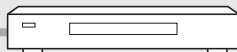

Connecting the TV (refer to "Startup Guide" (separate document))



"Connecting Sony TV with the BLUETOOTH Function Wirelessly" (page 14)

"Using the Control for HDMI Function" (page 26)
"Using the "BRAVIA" Sync Function" (page 27)

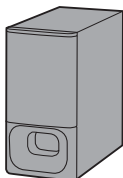
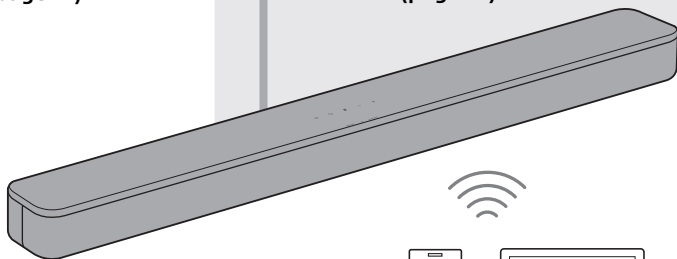

"Performing the Wireless Connection of the Subwoofer (SECURE LINK)" (page 25)

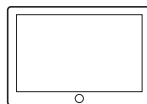

"Listening to Music from a Mobile Device" (page 22)

Guide to Parts and Controls

Details are omitted from the illustrations.

Bar Speaker

Front

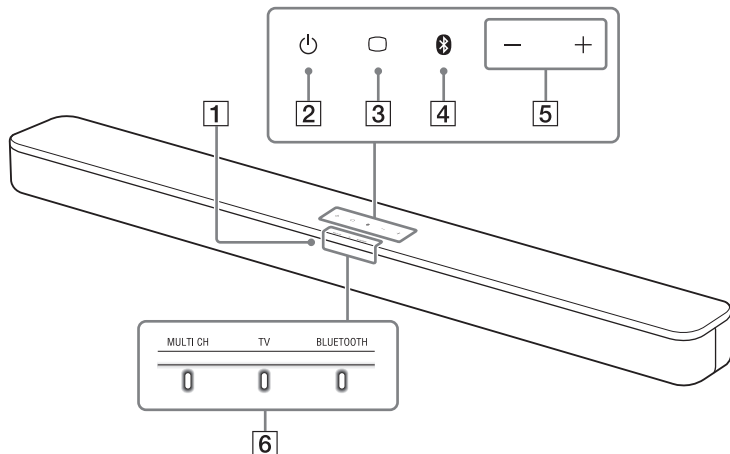

1 Remote control sensor

Point the remote control at the remote control sensor to operate the Sound Bar.

2 (power) button

Turns on the Sound Bar or sets it to standby mode.

3 (TV) button (page 19)



4 BLUETOOTH button (page 22)

5 +/- (volume) buttons

6 Indicators

A lighting or flashing of the indicators on the Bar Speaker indicates the following state.



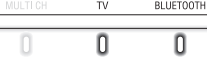



Currently selected input

Indicators	Status
	Lights while TV input is selected.
	Lights while BLUETOOTH input is selected.
	Light while the Sound Bar is connected to the TV with the BLUETOOTH function (TV input is selected).

Sound format, surround effect

Indicators	Status
	<ul style="list-style-type: none">Lights while 5.1ch Multi-channel sound is input.Flashes once while the sound mode is selected (page 20).

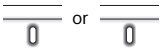
Volume

Indicators	Status
	Flashes once when the volume level is set to low (1 - 20).
	Flash once when the volume level is set to medium (21 - 40).
	Flash once when the volume level is set to high (41 - 49).
	<ul style="list-style-type: none">Flash repeatedly while the sound is muted.Flash twice when the volume level is set to maximum/minimum.
	The current input indicator flashes once when adjusting the subwoofer volume by pressing SW  +/-.
	Flash three times when the subwoofer volume level is set to maximum/minimum.

Setting value for each function

The on/off setting for each function is indicated by the number of times the following indicator flashes.

- On: Flashes twice.
- Off: Flashes once.

For the indicator status when settings other than the on/off setting are changed, see the description for each function.

Indicators	Functions
<p>MULTI CH</p> <hr/> <p>0</p>	<ul style="list-style-type: none">• Night mode (page 21)• Voice mode (page 21)
<p>BLUETOOTH</p> <hr/> <p>0</p>	<ul style="list-style-type: none">• Audio DRC (page 21)• Control for HDMI (page 26)• BLUETOOTH standby (page 24)• BLUETOOTH function (page 24)• Auto standby (page 28)• IR repeater (page 18)
<p>MULTI CH TV BLUETOOTH</p> <hr/> <p>0 0 0</p>	Connecting a TV with the BLUETOOTH function (page 14).

Rear

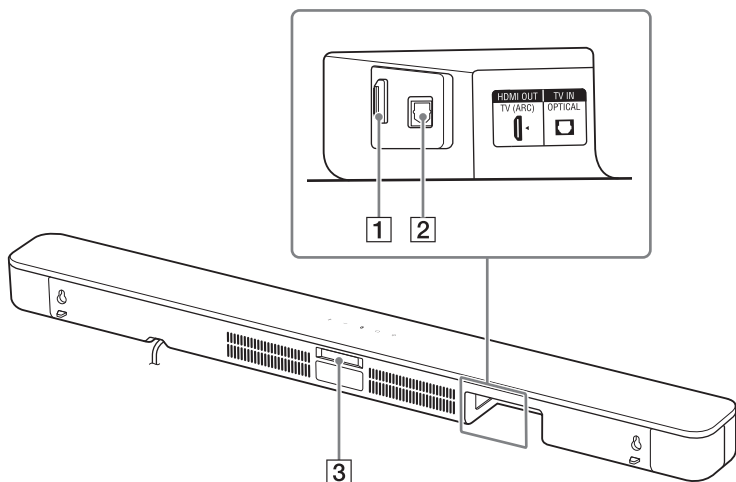

1 HDMI OUT (TV (ARC)) jack

Connect a TV that has an HDMI input jack with an HDMI cable (not supplied).

The Sound Bar is compatible with ARC (page 26). ARC is the function that sends TV sound to an AV device such as the Sound Bar from the TV's HDMI input jack.

2 TV IN (OPTICAL) jack

3 IR repeater (page 18)

Transmits the remote signal of the TV remote control to the TV.

Subwoofer

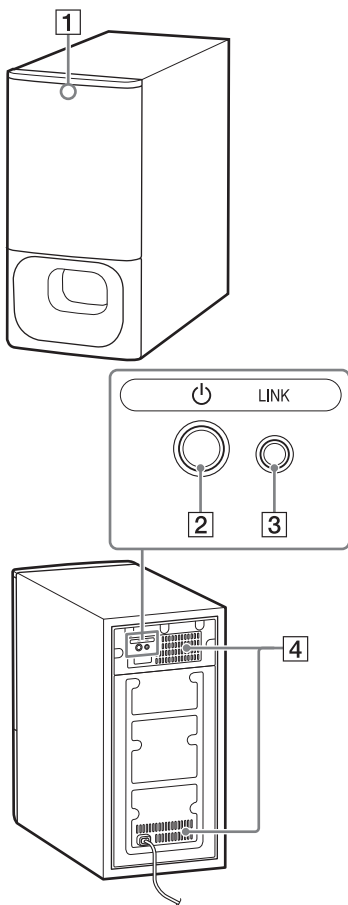

1 Status indicator

Indicates the status of the subwoofer power and Bar Speaker connection.

- Lights in green: The connection between the subwoofer and Bar Speaker is established.
- Flashes in green: The connection between the subwoofer and Bar Speaker is in progress.
- Lights in orange: The connection between the subwoofer and Bar Speaker is established with the Secure Link function.
- Flashes in orange: The connection between the subwoofer and Bar Speaker with the Secure Link function is in progress.
- Lights in red: The subwoofer is in standby mode.
- Lights off: The subwoofer is turned off.

2 (power) button

Turns on/off the subwoofer.

3 LINK button (page 25)

4 Ventilation holes

For safety, do not block the ventilation holes.

Remote Control

Some buttons function differently depending on how long the button is pressed. The icons below indicate how long to press the button.

- : Press the button.
- (with a horizontal bar): Press and hold the button for 5 seconds.

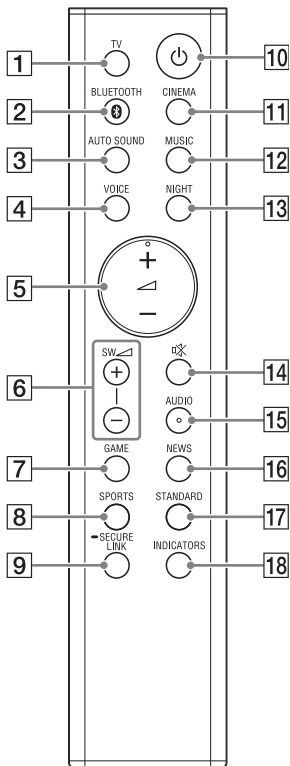



- 1 TV (page 19)**
Selects the TV input.
- 2 BLUETOOTH (page 19, 23)**
Selects the BLUETOOTH input.
- 3 AUTO SOUND (page 20)**
Selects AUTO SOUND for the sound effect.
- 4 VOICE**
●: Turns on/off the voice mode. (page 21)
● (with a horizontal bar): Turns on/off the Control for HDMI function. (page 26)
- 5 (volume) +/-**
Adjusts the volume.
- 6 SW (subwoofer volume) +/-**
Adjusts the volume of the subwoofer.
- 7 GAME (page 20)**
Selects GAME for the sound effect.
- 8 SPORTS (page 20)**
Selects SPORTS for the sound effect.
- 9 SECURE LINK (page 25)**
● (with a horizontal bar): Starts the link setting for the Secure Link function.
- 10 (power)**
Turns on the Sound Bar or sets it to standby mode.
- 11 CINEMA (page 20)**
Selects CINEMA for the sound effect.
- 12 MUSIC (page 20)**
Selects MUSIC for the sound effect.
- 13 NIGHT**
●: Turns on/off the night mode. (page 21)
● (with a horizontal bar): Turns on/off the BLUETOOTH standby mode. (page 24)

14 (muting)

Turns off the sound temporarily or turns on the sound.

15 **AUDIO***

: Selects the audio channel for Dolby Digital multiplex broadcast. (page 21)

: Turns on/off the Audio DRC function. (page 21)

16 **NEWS (page 20)**

Selects NEWS for the sound effect.

17 **STANDARD**

: Selects STANDARD for the sound effect. (page 20)

: Turns on/off the IR repeater function. (page 18)

18 **INDICATORS**

: Turns on/off the indicators on the Bar Speaker.

: Turns on/off the auto standby function. (page 28)

* The  + and AUDIO buttons have a tactile dot. Use it as a guide during operation.

Tip

You can turn the indicators off by pressing INDICATORS.

Even if the indicators are turned off by pressing INDICATORS, when you operate the Sound Bar, the indicators in relation to the operation light or flash.

About the replacement of batteries for the remote control

When the Sound Bar does not respond by operating with the remote control, replace two batteries with new batteries.

Use R03 (size AAA) manganese batteries for replacement.

Connecting a TV

Connecting a TV with an HDMI Cable

Refer to Startup Guide (separate document).

Connecting Sony TV with the BLUETOOTH Function Wirelessly

When using Sony TV* with the BLUETOOTH function, you can listen to sound of the TV or device that is connected to the TV by connecting the Sound Bar and TV wirelessly.

* The TV needs to be compatible with A2DP (Advanced Audio Distribution Profile).

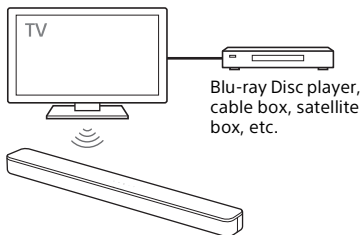

Connecting the Sound Bar and TV Wirelessly

To connect the Sound Bar and TV wirelessly, you need to perform pairing of the Sound Bar and TV by using the BLUETOOTH function.

Pairing is the process required to mutually register the information on

BLUETOOTH devices to be connected wirelessly in advance.

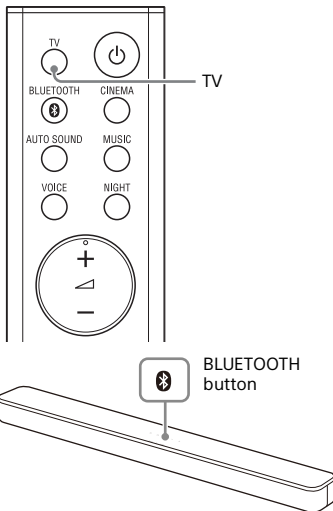

- 1** Insert batteries (supplied) into the remote control.
- 2** Turn on the TV.
- 3** Turn on the Bar Speaker and subwoofer.
- 4** Point the remote control at the remote control sensor on the Bar Speaker, and press and hold TV on the remote control and the BLUETOOTH button on the Bar Speaker simultaneously for 5 seconds.

The TV and BLUETOOTH indicators flash twice, the Sound Bar enters the pairing mode, then the BLUETOOTH indicator flashes quickly.

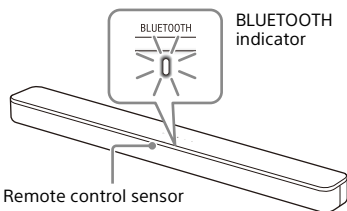

5 On the TV, search the Sound Bar by performing the pairing operation.

The list of the BLUETOOTH devices that are searched appears on the TV screen.

For the operation method to pair the BLUETOOTH device to the TV, refer to the operating instructions of the TV.

6 Pair the Sound Bar and TV by selecting "HT-S350" from the list on the TV screen.

7 Make sure that the TV and BLUETOOTH indicators on the Bar Speaker light.

A connection between the Sound Bar and TV has been established.

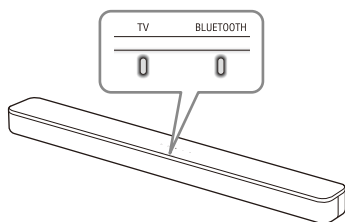

8 Select the program or input of the TV by using the TV remote control.

The sound of the displayed image on the TV screen is output from the Sound Bar.

9 Adjust the volume of the Sound Bar by using the TV remote control.

When pressing the muting button on the TV remote control, the sound is muted temporarily.

Notes

- If the TV sound is not output from the Sound Bar, press TV on the remote control of the Sound Bar to select the TV input and check the status of the indicators on the Bar Speaker.
 - The TV and BLUETOOTH indicators light: The Sound Bar and TV are connected and TV sound is output from the Sound Bar.
 - The BLUETOOTH indicator flashes quickly: Perform pairing on the TV.
 - The TV indicator lights: Perform the connecting operation again from the start.
- When you connect the Sound Bar and TV with an HDMI cable (not supplied), the BLUETOOTH connection is canceled. To connect the Sound Bar and TV with the BLUETOOTH function again, disconnect the HDMI cable, then perform the connecting operation from the start.
- To pair another TV after the first TV is paired, turn off the paired TV, then pair the new one by following the steps of mobile device connection (page 22).

Listening to the Sound of the TV or Device that is Connected to the TV

You can turn the Sound Bar on/off, adjust the volume, and mute the sound by using the TV remote control when connecting the TV to the Sound Bar wirelessly.

1 Turn the TV on with the TV remote control.

The Sound Bar is turned on by interlocking with the TV power and

TV sound is output from the Sound Bar.

- 2** **Select the program or input of the device by using the TV remote control.**

The sound of the image displayed on the TV screen is output from the Sound Bar.

- 3** **Adjust the volume of the Sound Bar by using the TV remote control.**

When pressing the mute button on the TV remote control, the sound is muted temporarily.

Tip

When the TV is turned off, the Sound Bar is also turned off by interlocking with the TV power.

Mounting the Bar Speaker on a Wall

You can mount the Bar Speaker on a wall.

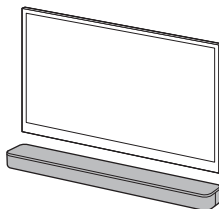

Notes

- Prepare screws (not supplied) that are suitable for the wall material and strength. As a plasterboard wall is especially fragile, attach the screws securely in the wall beam. Install the speakers horizontally, hung by screws in studs in a continuous flat section of the wall.
- Have the installation done by a Sony dealer or licensed contractor and pay special attention to safety during the installation.
- Sony shall not be held responsible for accidents or damage caused by improper installation, insufficient wall strength, improper screw installation or natural disaster, etc.

- 1 Prepare two screws (not supplied) that are suitable for the wall mount holes on the rear of the Bar Speaker.

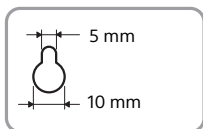
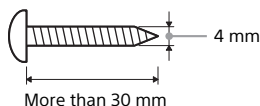

Hole on the rear of the Bar Speaker

- 2 Stick WALL MOUNT TEMPLATE (supplied) on a wall.

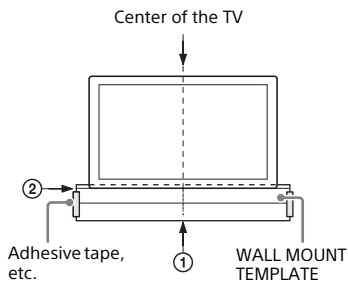

- 1 Align TV CENTER LINE (①) of WALL MOUNT TEMPLATE with the center line of your TV.
- 2 Align TV BOTTOM LINE (②) of WALL MOUNT TEMPLATE with the bottom of your TV, then stick WALL MOUNT TEMPLATE on a wall by using a commercially available adhesive tape, etc.

- 3 Fasten the screws into the marks (Ⓑ) on SCREW LINE (③) of WALL MOUNT TEMPLATE as in the illustration below.

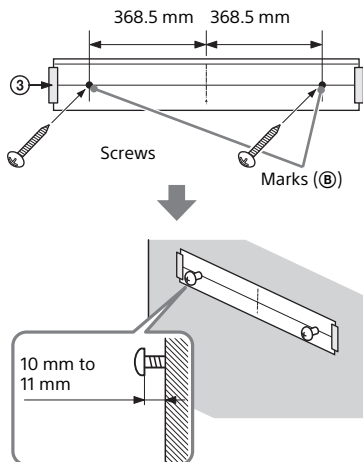

- 4 Remove WALL MOUNT TEMPLATE.
- 5 Hang the Bar Speaker on the screws.

Align the holes of the rear of the Bar Speaker with the screws, then hang the Bar Speaker on the two screws.

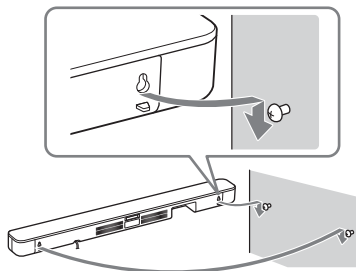

Note

When sticking WALL MOUNT TEMPLATE, smooth it out fully.

When the TV Remote Control does not Work

When the Bar Speaker obstructs the remote control sensor of the TV, the TV remote control may not work. In that case, enable the IR repeater function of the Sound Bar.

You can control the TV with the TV remote control by sending the remote signal from the rear of the Bar Speaker.

Press and hold STANDARD for 5 seconds to set the function to on or off.

IR repeater on

The BLUETOOTH indicator flashes twice.

IR repeater off

The BLUETOOTH indicator flashes once.

Notes

- Be sure to check that the TV remote control cannot control the TV, and then set the IR repeater function to on. If it is set to on when the remote control can control the TV, appropriate operation may not be obtained because of the interference between the direct command from the remote control and the command via the Bar Speaker.
- If the IR repeater function is set to on, this function may not work depending on your TV. Also, the remote controls of other devices such as an air conditioner may not work correctly. In this case, change the installation position of the Bar Speaker or TV.

Listening to the Sound

Listening to a TV and Other Devices

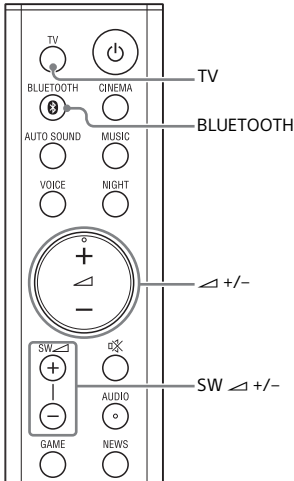

1 Press TV or BLUETOOTH.

The indicator of the selected input on the Bar Speaker lights.

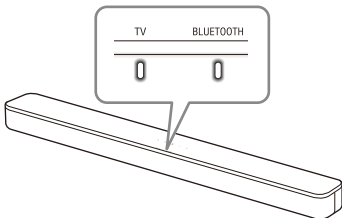

TV input

- TV that is connected to the TV IN (OPTICAL) jack on the Bar Speaker
- TV compatible with the ARC function that is connected to the HDMI OUT (TV (ARC)) jack on the Bar Speaker

When you connect the TV to both the HDMI OUT (TV (ARC)) and TV IN (OPTICAL) jacks, the jack for audio input is selected depending on which audio signal is input first.

BLUETOOTH input

BLUETOOTH device that supports A2DP
For details, see "Listening to Music from a Mobile Device" (page 22).

2 Adjust the volume.

- Adjust the volume by pressing \triangleleft +/- on the remote control.
- Adjust the subwoofer volume by pressing SW \triangleleft +/- on the remote control.

Tip

You can also select the input by pressing \square (TV) or BLUETOOTH on the Bar Speaker.

Notes

- When the input source does not contain much bass sound, such as in TV programs, the bass sound from the subwoofer may be difficult to hear.
- SW \triangleleft +/- does not work when the subwoofer is not connected.

Adjusting the Sound

Enjoying the Sound Effect that is Tailored to Sound Sources (Sound Mode)

You can easily enjoy pre-programmed sound effects that are tailored to different kinds of sound sources.

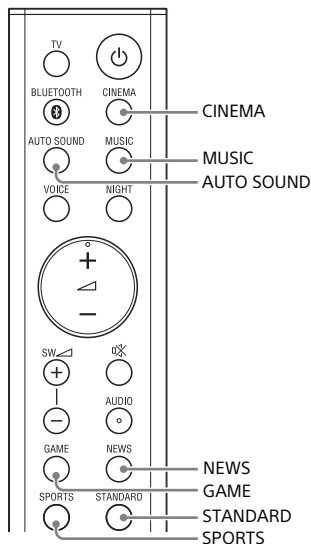

Press the sound mode selecting button to select the sound mode.

When selecting the sound mode, the MULTI CH indicator flashes once.

AUTO SOUND

You can enjoy the sound with Sony-recommended sound mode. The sound mode is automatically optimized according to playback content and function.

CINEMA

Sounds are played back with surround effects, and they are realistic and powerful, making them suitable for movies.

MUSIC

Sound effects are optimized for listening to music.

GAME

Sounds are powerful and realistic, suitable for game play.

NEWS

Clear speech of newscasts is recreated.

SPORTS





You can experience an atmosphere as if you were watching an event in a stadium. However, narrations of commentators are reproduced vividly.

STANDARD

Sound effects are optimized for each individual source.

Adjusting the Sound

You can adjust the sound with the buttons on the remote control.

Function name	Button	Function
Night mode		You can enjoy clear sound with low volume at midnight. <ul style="list-style-type: none">• On: The MULTI CH indicator flashes twice.• Off: The MULTI CH indicator flashes once. <p>Note When you turn the Sound Bar off, the night mode is set to off automatically.</p>
Voice mode		You can make dialogs clearer. <ul style="list-style-type: none">• On: The MULTI CH indicator flashes twice.• Off: The MULTI CH indicator flashes once.
Audio DRC	 Press and hold for 5 seconds	You can compress the dynamic range of the audio signal (range between the maximum and minimum volume) and sound with low volume is easy to hear. This function works only when playing the Dolby Digital signal. <ul style="list-style-type: none">• On: The BLUETOOTH indicator flashes twice.• Off: The BLUETOOTH indicator flashes once.
Multiplex broadcast sound		You can enjoy multiplex broadcast sounds when the Sound Bar receives a Dolby Digital multiplex broadcast signal. The setting changes cyclically in the order of Main → Sub → Main/Sub. <ul style="list-style-type: none">• Main: The MULTI CH indicator flashes once.• Sub: The BLUETOOTH indicator flashes once.• Main/Sub: Main sound is output from the left speaker and sub sound is output from the right speaker. The MULTI CH and BLUETOOTH indicators flash once.

Tip

AUDIO does not work while the BLUETOOTH indicator is lit.

Listening to Music/Sound with the BLUETOOTH® Function

Listening to Music from a Mobile Device

You can listen to music stored on a mobile device such as a smartphone or tablet via a wireless connection by connecting the Sound Bar and the mobile device with the BLUETOOTH function.

When connecting to the mobile device with the BLUETOOTH function, you can operate by simply using the supplied remote control without turning the TV on.

Listening to Music by Pairing with a Mobile Device

To listen to music of the mobile device with the BLUETOOTH function, you need to perform pairing of the Sound Bar and mobile device.

Pairing is the process required to mutually register the information on BLUETOOTH devices to be connected wirelessly in advance.

- 1 Press and hold the BLUETOOTH button on the Bar Speaker for 2 seconds.**

The Sound Bar enters the pairing mode and the BLUETOOTH indicator flashes quickly.

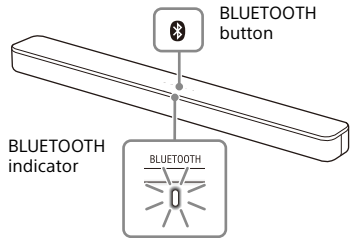

If pairing is not performed for 5 minutes after the Sound Bar enters the pairing mode, the pairing mode is canceled. In this case, perform pairing from the start.

- 2 On the mobile device, search the Sound Bar by performing the pairing operation.**

The list of the BLUETOOTH devices that are searched appears on the screen of the mobile device. For the operation method to pair the BLUETOOTH device to the mobile device, refer to the operating instructions of the mobile device.

- 3 Pair the Sound Bar and mobile device by selecting "HT-S350" from the list on the screen of the mobile device.**

If a Passkey is requested, enter "0000."

- 4 Make sure that the BLUETOOTH indicator on the Bar Speaker lights in blue.**

A connection between the Sound Bar and mobile device has been established.

- 5 Start audio playback with the music app on the connected mobile device.**

Sound is output from the Sound Bar.

6 Adjust the volume.

- Adjust the volume by pressing \triangleleft +/- on the remote control.
- Adjust the subwoofer volume by pressing SW \triangleleft +/- on the remote control.

To check the connection status of the BLUETOOTH function

Status	BLUETOOTH indicator
During pairing standby status	Flashes quickly in blue
Connection is being attempted	Flashes in blue
Connection has been established	Lights in blue

Notes

- You can pair the BLUETOOTH devices up to the following number.
 - Mobile devices: 9
 - Sony TV with the BLUETOOTH function: 1

If a new device is paired after pairing the above number of devices, the least recent connected device will be replaced by the new one.

- Perform pairing for the second and subsequent mobile devices.

Tips

- You can check the connection status of the BLUETOOTH function by checking the BLUETOOTH indicator status.
- While the BLUETOOTH input is being selected, the Sound Bar enters the pairing mode by pressing the BLUETOOTH button on the Bar Speaker shortly.
- While the BLUETOOTH input is not selected, the Sound Bar automatically reconnects to the BLUETOOTH device it was most recently connected to by pressing the BLUETOOTH button on the Bar Speaker shortly.

Listening to Music from the Paired Mobile Device

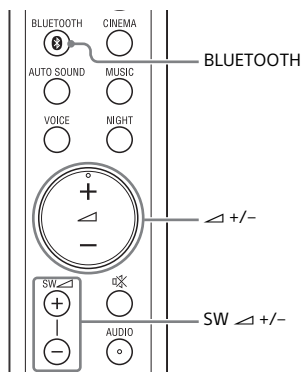

1 Turn the BLUETOOTH function of the mobile device on.

2 Press BLUETOOTH.

The BLUETOOTH indicator flashes and the Bar Speaker automatically reconnects to the BLUETOOTH device it was most recently connected to.

3 Make sure that the BLUETOOTH indicator lights in blue.

A connection between the Sound Bar and mobile device has been established.

4 Start audio playback with the music app on the connected mobile device.

Sound is output from the Sound Bar.

5 Adjust the volume.

- Adjust the volume by pressing \triangleleft +/- on the remote control.
- Adjust the subwoofer volume by pressing SW \triangleleft +/- on the remote control.

Turning the Sound Bar On by Operating the BLUETOOTH Device

When the Sound Bar has pairing information, you can turn the Sound Bar on and listen to music from a BLUETOOTH device even when the Sound Bar is in standby mode by setting the BLUETOOTH standby mode to on.

Press and hold NIGHT for 5 seconds to set the function to on or off.

BLUETOOTH standby mode on

The BLUETOOTH indicator flashes twice.

BLUETOOTH standby mode off



The BLUETOOTH indicator flashes once.

Note

While the BLUETOOTH standby mode is on, standby power consumption increases.

Turning the BLUETOOTH Function Off

You can turn the BLUETOOTH function off.

Press and hold , , and - on the Bar Speaker for 10 seconds to set the function to on or off.

BLUETOOTH function on

The BLUETOOTH indicator flashes twice.

BLUETOOTH function off

The BLUETOOTH indicator flashes once.

Using the Various Functions

Performing the Wireless Connection of the Subwoofer (SECURE LINK)

You can specify the wireless connection to link the Bar Speaker to the subwoofer using the Secure Link function. We recommend to perform the Secure Link function to prevent interference if you use multiple same products or your neighbors use same products.

Status indicator

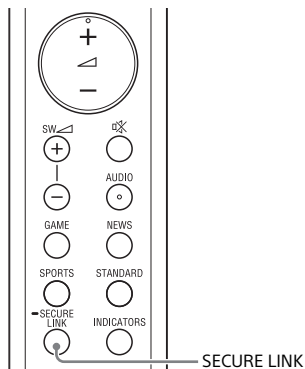
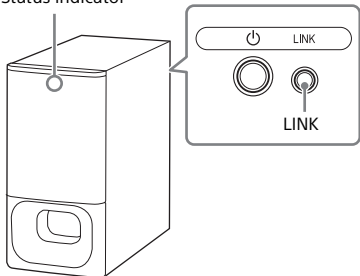

1 Press LINK on the rear of the subwoofer.

The status indicator of the subwoofer flashes in orange. Proceed to the next step within 2 minutes.

2 Press and hold SECURE LINK on the remote control for 5 seconds.

The link setting starts. The MULTI CH and TV indicators flash twice, then the indicators flash alternately.

3 Make sure that the MULTI CH and TV indicators stop flashing and the status indicator of the subwoofer lights in orange.

A connection between the Bar Speaker and subwoofer has been established.

If it fails, the MULTI CH and TV indicators light for 5 seconds. In this case, perform the Secure Link operation again.

To deactivate the Secure Link function

Press and hold SECURE LINK for 5 seconds.

The MULTI CH indicator flashes twice.

Using the Control for HDMI Function

Connecting a device such as a TV or Blu-ray Disc player compatible with the Control for HDMI function* using an HDMI cable enables you to easily operate the device by using a TV or Blu-ray Disc player remote control.

Note

These functions may work with devices other than those manufactured by Sony, but operation is not guaranteed.

* Control for HDMI is a standard used by CEC (Consumer Electronics Control) for allowing HDMI (High-Definition Multimedia Interface) devices to control each other.

Preparing to Use the Control for HDMI Function

Press and hold VOICE for 5 seconds to set the function to on or off.

Control for HDMI function on

The BLUETOOTH indicator flashes twice.

Control for HDMI function off

The BLUETOOTH indicator flashes once.

Enable the Control for HDMI function settings for the TV and other device connected to the TV.

System Power Off Function

When you turn off the TV, the Sound Bar will turn off automatically.

System Audio Control Function

If you turn on the Sound Bar while you are watching the TV, the TV sound will be output from the speakers of the Sound Bar. The volume of the Sound Bar can be adjusted using the TV remote control.

When you turn on the TV, the Sound Bar is turned on automatically and the TV sound is output from the speakers of the Sound Bar.

Operations can also be made by the TV's menu. For details, refer to the operating instructions of your TV.

Note

- The number for the volume level of the Sound Bar is displayed on the TV screen depending on the TV.
- Depending on the settings of the TV, the System Audio Control function may not be available. For details, refer to the operating instructions of your TV.
- Depending on the TV, if the TV sound was output from the speakers of the TV the previous time you watched the TV, the Sound Bar may not turn on by interlocking with the TV power even if the TV is turned on.

ARC (Audio Return Channel)

If the Sound Bar is connected to a TV's HDMI IN jack compatible with ARC, you can listen to TV sound from the speakers of the Sound Bar without connecting an optical digital cable.

Note

If the TV is not compatible with ARC, the optical digital cable (supplied) needs to be connected (refer to the supplied Startup Guide).

One-Touch Play Function

When you play content on a device (Blu-ray Disc player, "PlayStation®4," etc.) connected to the TV, the Sound Bar and TV are turned on automatically, the input of the Sound Bar is switched to TV input, and sound is output from the speakers of the Sound Bar.

Notes

- If the TV sound was output from the speakers of the TV the previous time you watched the TV, the Sound Bar may not turn on and the sound and picture may be output from the TV even if device content is played.
- Depending on the TV, the beginning part of content being played may not play correctly.

Using the "BRAVIA" Sync Function

In addition to the Control for HDMI function, you can also use the "BRAVIA" sync function such as the Sound mode/Scene Select function.

Note

This function is proprietary function of Sony. This function cannot operate with products other than those manufactured by Sony.

Sound mode/Scene Select Function

The sound mode of the Sound Bar is automatically switched according to the setting of the TV's Scene Select function or sound mode. For details, refer to the operating instructions of your TV. Set the sound mode to AUTO SOUND (page 20).

Notes on HDMI Connections

- Use an HDMI-authorized cable.
- We recommend using a Sony High Speed HDMI Cable with Ethernet with the Cable Type Logo.
- We do not recommend using an HDMI-DVI conversion cable.
- Audio signals (sampling frequency, bit length, etc.) transmitted from an HDMI jack may be suppressed by the connected device.

Saving Power Consumption

To use the Sound Bar while saving power consumption, change the following settings.

Turn the Sound Bar Off by Detecting the Using State

When you set the auto standby function to on, the Sound Bar enters standby mode automatically when you do not operate the Sound Bar for about 20 minutes and the Sound Bar is not receiving an input signal.

Press and hold INDICATORS for 5 seconds to set the function to on or off.

Auto standby on

The BLUETOOTH indicator flashes twice. The default setting for models of the Europe countries is on.

Auto standby off

The BLUETOOTH indicator flashes once. The default setting for India/Australia/New Zealand models is off.

Saving Power in Standby Mode

To save power consumption during the standby mode, set the BLUETOOTH standby mode (page 24) and Control for HDMI function (page 26) to off. The default settings for them are on.

Troubleshooting

Troubleshooting

If you experience any of the following difficulties while using the Sound Bar, use this troubleshooting guide to help remedy the problem before requesting repairs. Should any problem persist, consult your nearest Sony dealer.

Be sure to bring both your Bar Speaker and subwoofer, even if it seems as though only one has a problem, when you request to repair.

Power

The Sound Bar does not power up.

- Check that the AC power cord (mains lead) is connected securely.
- Disconnect the AC power cord (mains lead) from the wall outlet (mains), and then reconnect after several minutes.

The Sound Bar is turned off automatically.

- The auto standby function is working. Set the auto standby function to off (page 28).

The Sound Bar does not turn on even when the TV is turned on.

- Set the Control for HDMI function to on (page 26). The TV must support the Control for HDMI function. For details, refer to the operating instructions of your TV.
- Check the speaker settings of the TV. The Sound Bar power syncs with the speaker settings of the TV. For details, refer to the operating instructions of your TV.
- Depending on the TV, if the sound was output from the speakers of the TV the previous time, the Sound Bar

may not turn on by interlocking with the TV power even when the TV is turned on.

The Sound Bar turns off when the TV is turned off.

- Check the setting of the Control for HDMI function (page 26). When the Control for HDMI function is set to on and the input of the Sound Bar is the TV input, the Sound Bar turns off automatically when you turn off the TV.

The Sound Bar does not turn off even when the TV is turned off.

- Check the setting of the Control for HDMI function (page 26). When you turn off the TV, the Sound Bar turns off automatically only if the input of the Sound Bar is the TV input. The TV must support the Control for HDMI function. For details, refer to the operating instructions of your TV.

Picture

There is no picture or the picture is not output correctly.

- When there is no picture while TV input is selected, select the TV channel that you want using the TV remote control.

Sound

The Sound Bar cannot connect to a TV with the BLUETOOTH function.

- When you connect the Sound Bar and TV with an HDMI cable (not supplied), the BLUETOOTH connection is canceled. Disconnect the HDMI cable, then perform the connecting operation from the start (page 14).

No TV sound is output from the Sound Bar.

- Check the type and connection of the HDMI cable or optical digital cable that is connected to the Sound Bar and the TV (refer to the supplied Startup Guide).
- Disconnect the cables that are connected between the TV and the Sound Bar, then connect them firmly again. Disconnect the AC power cords of the TV and the Sound Bar from the AC outlets (mains), then connect them again.
- When the Sound Bar and TV are connected with an HDMI cable only, check the following.
 - The HDMI jack of the connected TV is labeled with “ARC.”
 - The Control for HDMI function of the TV is set to on.
 - On the Sound Bar, the Control for HDMI function is set to on (page 26).
- If your TV is not compatible with ARC, connect the optical digital cable (supplied) (refer to the supplied Startup Guide). If the TV is not compatible with ARC, TV sound will not be output from the Sound Bar even if the Sound Bar is connected to the TV's HDMI IN jack.
- Select the TV input by pressing TV (page 19).
- Increase the volume on the TV or cancel muting.
- Depending on the order in which you connect the TV and the Sound Bar, the Sound Bar may be muted. If this happens, turn on the TV first, then the Sound Bar.
- Set the speakers setting of the TV (BRAVIA) to Audio System. Refer to the operating instructions of your TV regarding how to set the TV.
- Check the sound output of the TV. Refer to the operating instructions of the TV for the TV settings.
- The Sound Bar supports the Dolby Digital and PCM audio formats

(page 36). When you playback an unsupported format, set the digital audio out setting of the TV (BRAVIA) to “PCM.” For details, refer to the operating instructions of your TV.

The sound is output from both the Sound Bar and the TV.

- Change the audio output setting of the TV so that the TV sound is output from the external speaker.
- Set the TV volume to minimum.

The output sound of the Sound Bar is not the same level as that of the TV even though the values of the volume level on the Sound Bar and TV are set to the same value.

- If the Control for HDMI function is set to on, the value of the volume level on the Sound Bar may appear on your TV as the TV volume. The output sound levels of the Sound Bar and TV differ even though the values of the volume level on the Sound Bar and TV are set to the same value. The output sound levels of the Sound Bar and TV differ depending on the sound processing characteristics of each, and it is not a malfunction.

The sound is interrupted while watching a TV program or content on a Blu-ray Disc, etc.

- Check the sound mode setting (page 20). If the sound mode is set to AUTO SOUND, the sound may be interrupted when the sound mode is changed automatically according to the information of the program that is being played. If you do not want to change the sound mode automatically, set the sound mode to a setting other than AUTO SOUND.

No sound or only a very low-level sound of the device connected to the Sound Bar is heard from the Sound Bar.

- Press + and check the volume level (page 12).
- Press or + to cancel the muting function (page 12).
- Make sure the input source is selected correctly (page 19).
- Check that all the cables and cords of the Sound Bar and the connected device are firmly inserted.
- If the connected device supports up-sampling feature, you need to turn it off.

The surround effect cannot be obtained.

- Depending on the input signal and the sound mode setting, surround sound processing may not work effectively. The surround effect may be subtle, depending on the program or disc.
- To play multi channel audio, check the digital audio output setting on the device connected to the Sound Bar. For details, refer to the operating instructions supplied with the connected device.

Subwoofer

No sound or only very low-level sound is heard from the subwoofer.

- Press SW + on the remote control to increase the subwoofer volume.
- Make sure that the status indicator on the subwoofer is lit in green or orange.
- If the status indicator on the subwoofer does not light, try the following.
 - Make sure the AC power cord (mains lead) of the subwoofer is connected properly.

- Press (power) of the subwoofer to turn on the power.
- If the status indicator on the subwoofer lights in red, try the following.
 - Move the subwoofer to a location near the Bar Speaker so that the status indicator on the subwoofer lights in green or orange.
 - Follow the steps in “Performing the Wireless Connection of the Subwoofer (SECURE LINK)” (page 25).
- If the status indicator on the subwoofer flashes in red, press (power) of the subwoofer to turn off the power and check whether the ventilation holes of the subwoofer is blocked or not.
- If the input sources contain very little bass sound components (i.e., a TV broadcast), the sound from the subwoofer may be difficult to hear. Play the built-in demonstration music by following the steps below and check that the sound is output from the subwoofer.
 - ① Press and hold (TV) on the Bar Speaker for 5 seconds. The built-in demonstration music is played.
 - ② Press (TV) again. The built-in demonstration music is canceled and the Sound Bar returns to the previous status.
- Set the night mode to off (page 21).

Mobile Device Connection

BLUETOOTH connection cannot be completed.

- Make sure that the BLUETOOTH indicator on the Bar Speaker is lit (page 7).
- Make sure the BLUETOOTH device to be connected is turned on and the BLUETOOTH function is enabled.

- Bring the BLUETOOTH device close to the Bar Speaker.
- Pair the Sound Bar and the BLUETOOTH device again. You may need to cancel the pairing with the Sound Bar using your BLUETOOTH device first.
- If the BLUETOOTH function is set to off, set it to on (page 24).

Pairing cannot be achieved.

- Bring the BLUETOOTH device close to the Bar Speaker.
- Make sure the Sound Bar is not receiving interference from a wireless LAN device, other 2.4 GHz wireless devices, or a microwave oven. If a device that generates electromagnetic radiation is nearby, move the device away from the Sound Bar.
- Pairing may not be possible if other BLUETOOTH devices are present around the Sound Bar. In this case, turn off the other BLUETOOTH devices.

Sound of the connected BLUETOOTH mobile device is not output from the Sound Bar.

- Make sure that the BLUETOOTH indicator on the Bar Speaker is lit (page 7).
- Bring the BLUETOOTH device close to the Bar Speaker.
- If a device that generates electromagnetic radiation, such as a wireless LAN device, other BLUETOOTH devices, or a microwave oven is nearby, move the device away from the Sound Bar.
- Remove any obstacle between the Bar Speaker and the BLUETOOTH device or move the Bar Speaker away from the obstacle.
- If the Bar Speaker is installed under the TV, move the Bar Speaker away from the TV.

- Reposition the connected BLUETOOTH device.
- Switch the wireless LAN frequency of any nearby wireless LAN router or PC to 5 GHz range.
- Increase the volume on the connected BLUETOOTH device.

The sound is not in sync with the image.

- When you are watching movies, you may hear the sound with a slight delay from the image.

Remote Control

The remote control of the Sound Bar does not function.

- Point the remote control at the remote control sensor on the Bar Speaker (page 7).
- Remove any obstacles in the path between the remote control and the Sound Bar.
- Replace both batteries in the remote control with new ones, if they are weak.
- Make sure you are pressing the correct button on the remote control (page 12).

The TV remote control does not work.

- Install the Bar Speaker so that it does not obstruct the remote control sensor of the TV.
- This problem might be solved by enabling the IR repeater function (page 18).

Others

The Control for HDMI function does not work properly.

- Check the connection with the Sound Bar (refer to the supplied Startup Guide).

- Enable the Control for HDMI function on the TV. For details, refer to the operating instructions of your TV.
- Wait a while, and then try again. If you unplug the Sound Bar, it will take a while before operations can be made. Wait for 15 seconds or longer, and then try again.
- Make sure the devices connected to the Sound Bar support the Control for HDMI function.
- Enable the Control for HDMI function of the devices connected to the Sound Bar. For details, refer to the operating instructions of your device.
- The type and number of devices that can be controlled by the Control for HDMI function is restricted by the HDMI CEC standard as follows:
 - Recording devices (Blu-ray Disc recorder, DVD recorder, etc.): up to 3 devices
 - Playback devices (Blu-ray Disc player, DVD player, etc.): up to 3 devices
 - Tuner-related devices: up to 4 devices
 - Audio system (receiver/headphone): up to 1 device (used by the Sound Bar)

All indicators on the Bar Speaker flash for 10 seconds and the Sound Bar is turned off.

- The protection feature is activated. Disconnect the AC power cord (mains lead) and make sure that the ventilations of the Bar Speaker are not covered and turn on the Sound Bar after a while.

Sensors of the TV do not work properly.

- The Bar Speaker may block some sensors (such as the brightness sensor), the remote control sensor of your TV or the emitter for 3D glasses (infrared transmission) of a 3D TV that supports the infrared 3D glass

system, or wireless communication. Move the Bar Speaker away from the TV within a range that allows those parts to operate properly. For the locations of the sensors and remote control receiver, refer to the operating instructions supplied with the TV.

The Sound Bar does not work properly.

- The Sound Bar may be in demo mode. To cancel demo mode, reset the Sound Bar. Press and hold – (volume) and ⏻ (power) on the Bar Speaker for more than 5 seconds (page 34).

The following message appears.



• Please select the desired TV channels with the TV's remote control.

* This screen is an example for English.

- Select the TV program by using the TV remote control.

Resetting the Sound Bar

If the Sound Bar still does not operate properly, reset the Sound Bar as follows.

- 1 Press and hold – (volume) and  (power) on the Bar Speaker for more than 5 seconds.**
All indicators on the Bar Speaker flash 3 times, and the settings return to their initial status.
- 2 Disconnect the AC power cord (mains lead).**
- 3 Connect the AC power cord (mains lead), then press  to turn on the Sound Bar.**

Tip

The default settings are underlined on each feature description.

Additional Information

Specifications

Bar Speaker (SA-S350)

Amplifier section

POWER OUTPUT (rated)

Front L + Front R: 45 W + 45 W (at 4 ohms, 1 kHz, 1% THD)

POWER OUTPUT (reference)

Front L/Front R speaker: 85 W (per channel at 4 ohms, 1 kHz)

Inputs

TV IN (OPTICAL)

Outputs

HDMI OUT (TV (ARC))

BLUETOOTH section

Communication system

BLUETOOTH Specification version 5.0

Output

BLUETOOTH Specification Power Class 1

Maximum communication range

Line of sight approx. 25 m¹⁾

Frequency band

2.4 GHz band (2.4000 GHz - 2.4835 GHz)

Maximum output power

< 9 dBm

Modulation method

FHSS (Freq Hopping Spread Spectrum)

Compatible BLUETOOTH profiles²⁾

A2DP (Advanced Audio Distribution Profile)

AVRCP (Audio Video Remote Control Profile)

Supported Codec³⁾

SBC⁴⁾

Transmission range (A2DP)

20 Hz - 20,000 Hz (Sampling frequency 32 kHz, 44.1 kHz, 48 kHz)

- 1) The actual range will vary depending on factors such as obstacles between devices, magnetic fields around a

microwave oven, static electricity, cordless phone use, reception sensitivity, the operating system, software applications, etc.

- 2) BLUETOOTH standard profiles indicate the purpose of BLUETOOTH communication between devices.
3) Codec: Audio signal compression and conversion format
4) Abbreviation for Subband Codec

Front L/Front R speaker block section

Speaker system

2 Speaker System

Speaker

Front L/Front R speaker: 52 mm × 90 mm cone type, 4 Ω

General

Power requirements

220 V - 240 V AC, 50 Hz/60 Hz

Power consumption

On: 30 W

Standby mode: 0.5 W or less (Power Saving mode)

(When Control for HDMI function and BLUETOOTH Standby mode are set to off)

Standby mode: 2 W or less*

(When Control for HDMI function and BLUETOOTH Standby mode are set to on)

* The Sound Bar will automatically enter Power saving mode when there is no HDMI connection and no BLUETOOTH pairing history.

Dimensions* (approx.) (w/h/d)

900 mm × 64 mm × 88 mm

* Not including projection portion

Mass (approx.)

2.4 kg

Subwoofer (SA-WS350)

POWER OUTPUT (reference)

150 W (at 2.5 ohms, 100 Hz)

Speaker system

Subwoofer speaker system, Bass reflex

Speaker

160 mm cone type

Power requirements

220 V - 240 V AC, 50 Hz/60 Hz

Power consumption

On: 25 W

Standby mode: 0.5 W or less

Dimensions* (approx.) (w/h/d)

190 mm × 382 mm × 390 mm

* Not including projection portion

Mass (approx.)

7.8 kg

Wireless Transmitter/ Receiver Section

Frequency band

2.4 GHz (2.4000 GHz - 2.4835 GHz)

Maximum output power

< 9 dBm

Modulation method

FHSS (Freq Hopping Spread Spectrum)

Design and specifications are subject to change without notice.

Supported Input Audio Formats (TV Input)

Audio formats supported by the Sound Bar are as follows.

- Dolby Digital
- Linear PCM 2ch

On BLUETOOTH Communication

- BLUETOOTH devices should be used within approximately 10 meters (33 feet) (unobstructed distance) of each other. The effective communication range may become shorter under the following conditions:
 - When a person, metal object, wall or other obstruction is between the devices with a BLUETOOTH connection
 - Locations where a wireless LAN is installed
 - Around microwave ovens that are in use
 - Locations where other electromagnetic waves occur
 - BLUETOOTH devices and wireless LAN (IEEE 802.11b/g/n) use the same frequency band (2.4 GHz). When using your BLUETOOTH device near a device with wireless LAN capability, electromagnetic interference may occur. This could result in lower data transfer rates, noise, or inability to connect. If this happens, try the following remedies:
 - Use this Sound Bar at least 10 meters (33 feet) away from the wireless LAN device.
 - Turn off the power to the wireless LAN device when using your BLUETOOTH device within 10 meters (33 feet).
 - Install this Sound Bar and BLUETOOTH device as closer to each other as possible.
 - The radio waves broadcast by this Sound Bar may interfere with the operation of some medical devices. Since this interference may result in malfunction, always turn off the power on this Sound Bar and BLUETOOTH device in the following locations:
 - In hospitals, on trains, in airplanes, at gas stations, and any place where flammable gasses may be present
 - Near automatic doors or fire alarms
 - This Sound Bar supports security functions that comply with the BLUETOOTH specification to ensure secure connection during communication using BLUETOOTH technology. However, this security may be insufficient depending on the setting contents and other factors, so always be careful when performing communication using BLUETOOTH technology.
 - Sony cannot be held liable in any way for damages or other loss resulting from information leaks during communication using BLUETOOTH technology.
 - BLUETOOTH communication is not necessarily guaranteed with all BLUETOOTH devices that have the same profile as this Sound Bar.
 - BLUETOOTH devices connected with this Sound Bar must comply with the BLUETOOTH specification prescribed by the Bluetooth SIG, Inc., and must be certified to comply. However, even when a device complies with the BLUETOOTH specification, there may be cases where the characteristics or specifications of the BLUETOOTH device make it impossible to connect, or may result in different control methods, display or operation.
 - Noise may occur or the audio may cut off depending on the BLUETOOTH device connected with this Sound Bar, the communications environment, or surrounding conditions.
- If you have any questions or problems concerning your Sound Bar, please consult your nearest Sony dealer.

Precautions

On safety

- Should any solid object or liquid fall into the Sound Bar, unplug the Sound Bar and have it checked by qualified personnel before operating it any further.
- Do not climb on the Sound Bar, as you may fall down and injure yourself, or Sound Bar damage may result.

On power sources

- Before operating the Sound Bar, check that the operating voltage is identical to your local power supply. The operating voltage is indicated on the nameplate on the bottom of the Bar Speaker.
- If you are not going to use the Sound Bar for a long time, be sure to disconnect the Sound Bar from the wall outlet (mains). To disconnect the AC power cord (mains lead), grasp the plug itself; never pull the cord.
- One blade of the plug is wider than the other for the purpose of safety and will fit into the wall outlet (mains) only one way. If you are unable to insert the plug fully into the outlet, contact your dealer.
- AC power cord (mains lead) must be changed only at a qualified service shop.

On heat buildup

Although the Sound Bar heats up during operation, this is not a malfunction. If you continuously use this Sound Bar at high volume, the Sound Bar temperature at the rear and bottom rises considerably. To avoid burning yourself, do not touch the Sound Bar.

On placement

- Place the Sound Bar in a location with adequate ventilation to prevent heat buildup and prolong the life of the Sound Bar.
- Do not place the Sound Bar near heat sources or in a place subject to direct

sunlight, excessive dust, or mechanical shock.

- Do not place anything on the top of the Bar Speaker.
- If the Sound Bar is being used in combination with a TV, VCR, or tape deck, noise may result and picture quality may suffer. In such a case, place the Sound Bar away from the TV, VCR, or tape deck.
- Use caution when placing the Sound Bar on a surface that has been specially treated (with wax, oil, polish, etc.), as staining or discoloration of the surface may result.
- Take care to avoid any possible injury from the corners of the Bar Speaker.

On operation

Before connecting other equipment, be sure to turn off and unplug the Sound Bar.

If you encounter color irregularity on a nearby TV screen

Color irregularities may be observed on certain types of TV.

- If color irregularity is observed...
Turn off the TV, then turn it on again after 15 to 30 minutes.
- If color irregularity is observed again...
Place the Sound Bar further away from the TV.

On cleaning

Clean the Sound Bar with a soft, dry cloth. Do not use any type of abrasive pad, scouring powder, or solvent such as alcohol or benzene.

If you have any question or problem concerning your Sound Bar, please consult your nearest Sony dealer.

Copyrights and Trademarks

This Sound Bar incorporates Dolby* Digital.

* Manufactured under license from Dolby Laboratories.

Dolby, Dolby Audio and the double-D symbol are trademarks of Dolby Laboratories.

The BLUETOOTH® word mark and logos are registered trademarks owned by Bluetooth SIG, Inc. and any use of such marks by Sony Corporation is under license. Other trademarks and trade names are those of their respective owners.

The terms HDMI, HDMI High-Definition Multimedia Interface, and the HDMI Logo are trademarks or registered trademarks of HDMI Licensing Administrator, Inc.

“BRAVIA” logo is a trademark of Sony Corporation.

“PlayStation” is a registered trademark or trademark of Sony Interactive Entertainment Inc.

MPEG Layer-3 audio coding technology and patents licensed from Fraunhofer IIS and Thomson.

Windows Media is either a registered trademark or trademark of Microsoft Corporation in the United States and/or other countries.

This product is protected by certain intellectual property rights of Microsoft Corporation. Use or distribution of such technology outside of this product is prohibited without a license from Microsoft or an authorized Microsoft subsidiary.

All other trademarks are trademarks of their respective owners.

HDMI

<http://www.sony.net/>



* 4 7 4 8 7 5 8 1 2 * (1)

©2019 Sony Corporation Printed in Malaysia

4-748-758-12(1)