

SONY®

4-748-307-12(1)



Television

Reference Guide



Customer Support and Contact:
<http://www.sony-asia.com/support>

BRAVIA

KD-85X8500G / 75X8500G / 65X8577G / 65X8500G / 55X8577G / 55X8500G

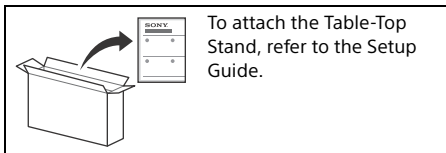

Introduction

Thank you for choosing this Sony product. Before operating the TV, please read this manual thoroughly and retain it for future reference.

Note

- Before operating the TV, please read the "Safety Information" (page 2).
- Read the supplied Safety Information for additional safety information.
- Instructions about "Installing the TV to the Wall" are included within this TV's instruction manual.
- Images and illustrations used in the Setup Guide and this manual are for reference only and may differ from the actual product.

Table of Contents

| | |
|---|----|
| Safety Information | 2 |
| Parts and Controls | 5 |
| Controls and Indicators | 5 |
| Using Remote Control | 6 |
| Remote Control Parts Description | 6 |
| Connection Diagram | 8 |
| Installing the TV to the Wall | 10 |
| Using the optional Wall-Mount Bracket | 10 |
| Detaching the Table-Top Stand from the TV | 11 |
| Troubleshooting | 12 |
| Troubles and Solutions | 12 |
| Specifications | 13 |

Help

Find more troubleshooting and other useful information directly from your TV. Press **HELP** on the remote control to display a list of topics, or to search by keyword.

Help Guide (Manual)

For more detailed information, select [Help Guide] from the Help menu on your TV. You can also check the Help Guide from your PC or smartphone (information provided on the back cover of this manual).

Location of the identification label

Labels for the TV Model No. and Power Supply rating are located on the rear of the TV.

Safety Information

Installation/Set-up

Install and use the TV set in accordance with the instructions below in order to avoid any risk of fire, electric shock or damage and/or injuries.

Installation

- The TV set should be installed near an easily accessible AC power outlet (mains socket).
- Place the TV set on a stable, level surface to prevent it from falling over and causing personal injury or property damage.
- Install the TV where it cannot be pulled, pushed, or knocked over.
- Install the TV so that the TV's Table-Top Stand does not protrude out from the TV stand (not supplied). If the Table-Top Stand protrudes out from the TV stand, it may cause TV set to topple over, fall down, and cause personal injury or damage to the TV.

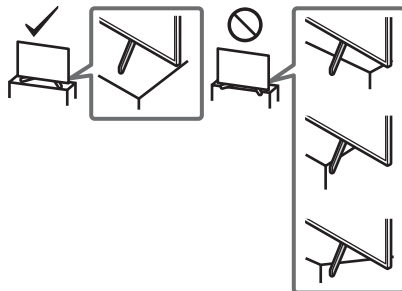

- Only qualified service personnel should carry out wall-mount installations.
- For safety reasons, it is strongly recommended that you use Sony accessories, including:
 - Wall-Mount Bracket SU-WL450

- Be sure to use the screws supplied with the Wall-Mount Bracket when attaching the Wall-Mount Bracket to the TV set. The supplied screws are designed as indicated by illustration when measured from the attaching surface of the Wall-Mount Bracket. The diameter and length of the screws differ depending on the Wall-Mount Bracket model. Use of screws other than those supplied may result in internal damage to the TV set or cause it to fall, etc.

KD-85X8500G

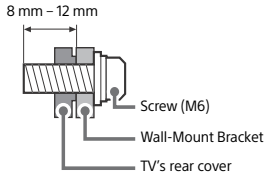

KD-75/65/55X8500G, KD-65/55X8577G

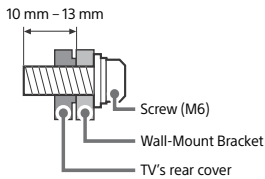

KD-75/65/55X8500G, KD-65/55X8577G

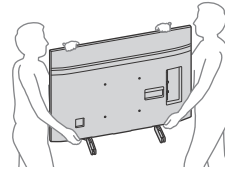

- When transporting the TV set, do not subject it to jolts or excessive vibration.
- When transporting the TV set for repairs or when moving, pack it using the original carton and packing material.

Transporting

- Before transporting the TV set, disconnect all cables.
- Two or more people (three or more people for KD-85X8500G) are needed to transport a large TV set.
- When transporting the TV set by hand, hold it as shown below. Do not put stress on the LCD panel and the frame around the screen.
- When lifting or moving the TV set, hold it firmly from the bottom.

KD-85X8500G

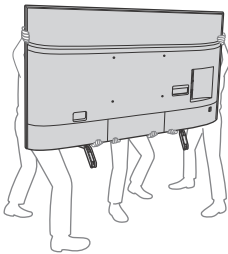

Topple prevention

(Models with supplied support belt kit)

Refer to the Setup Guide on top of the cushion.
The supplied wood screw is only for affixing to a solid object made of wood.

(Except models with supplied support belt kit)

KD-85X8500G

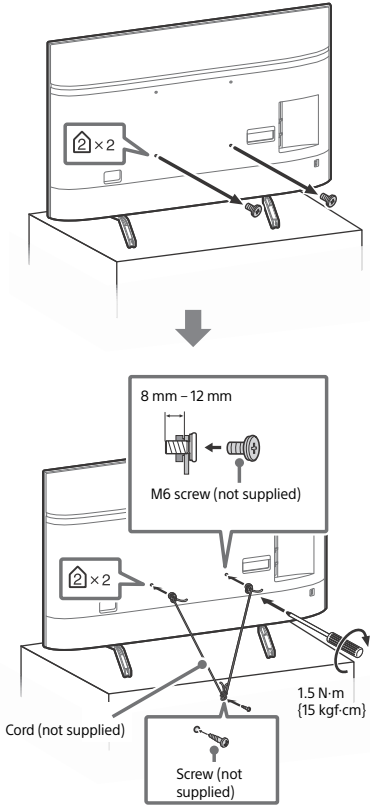

KD-75/65/55X8500G, KD-65/55X8577G

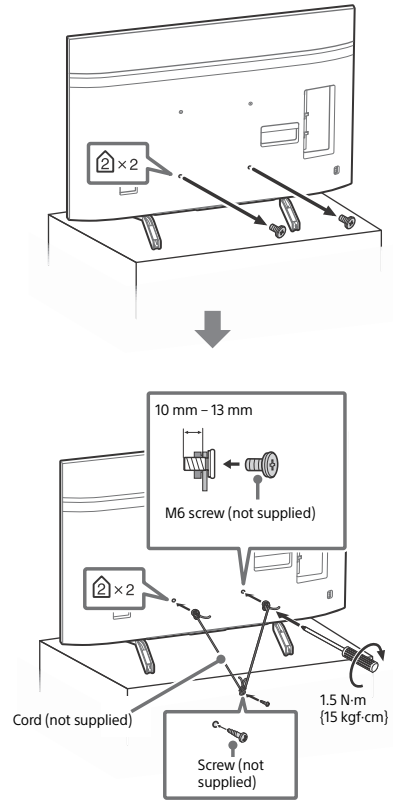

Notice for customer in UAE

TRA

REGISTERED No: ER63944/18
DEALER No: DA0065531/11

Parts and Controls

Controls and Indicators

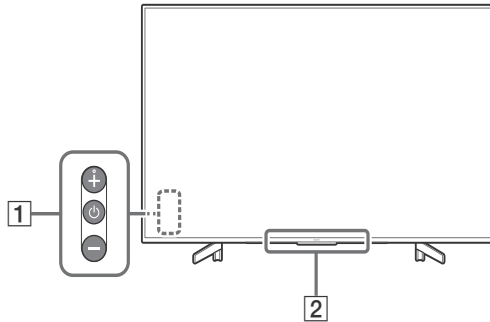

1 **⏻ (Power) /+/-**

When the TV is off,

Press **⏻** to power on.

When the TV is on,

Press and hold **⏻** to power off.

Press **⏻** repeatedly to change the function,
then press + or - button to:

- Adjust the volume.
- Select the channel.
- Select the input source of TV.

2 **Remote Control sensor* / Light sensor* / Illumination LED**

The illumination LED lights up or blinks
according to the status of the TV.

For more information, refer to the Help
Guide.



* Do not place anything near the sensor.

Using Remote Control

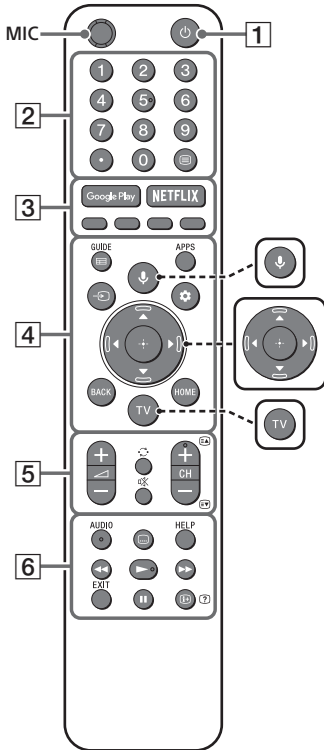

Remote Control Parts Description

The remote control shape, location, availability and function of remote control buttons may vary depending on your region/country/TV model.



-  **🗣️ (Microphone)**
Use voice search*. (e.g., Search various content by voice.)
-  **▲/▼/◀/▶/⊕ (Navigation D-Pad)**
On screen menu navigation and selection.
-  **TV**
Switch to a TV channel or input and display the TV menu.

* The voice search requires an Internet connection.

- 1**  **(TV standby)**
Turn on or turn off the TV (standby mode).
- 2** **Number buttons**

Use with the 0-9 buttons to select digital channels.
 **(Text)**
Display text information.
- 3** **Google Play**
Access the “Google Play” online service.

NETFLIX (Only on limited region/country/TV model)

Access the “NETFLIX” online service.

Colour buttons

Execute corresponding function at that time.

- 4**  **GUIDE/EPG**
Display the digital programme guide, or EPG of cable/satellite box after setting [Cable/Satellite box setup] (Set top box control compatible models only).

APPS

Display a list of installed apps.

(Input select)

Display and select the input source, etc.

(Quick settings)

Display Quick Settings.

BACK

Return to the previous screen.

HOME

Display the TV Home Menu.

5 +/- (Volume)

Adjust the volume.

(Jump)

Jump back and forth between two channels or inputs. The TV alternates between the current channel or input and the last channel or input that was selected.

(Mute)



Mute the sound. Press again to restore the sound.

Hint

- The accessibility shortcut service can be turned on or off by pressing and holding .

CH +/- / /

In TV mode: Select the channel.

In Text mode: Select the next () or previous () page.

6 AUDIO

Select the sound of multilingual source or dual sound for the programme currently being viewed (depend on programme source).

(Subtitle setting)

Turn subtitles on or off (when the feature is available).

HELP

Display the Help menu. Help Guide can be accessed from here.

Operate media contents on the TV and connected BRAVIA Sync-compatible device.

EXIT

Return to the previous screen or exit from the menu. When an Interactive Application service is available, press to exit from the service.

/ (Info/Text reveal)

Display information.

Note

- For more information about [Cable/Satellite box setup], refer to the Help Guide.

Connection Diagram

For more information on connections, refer to the Help Guide by pressing **HELP** on the remote control.

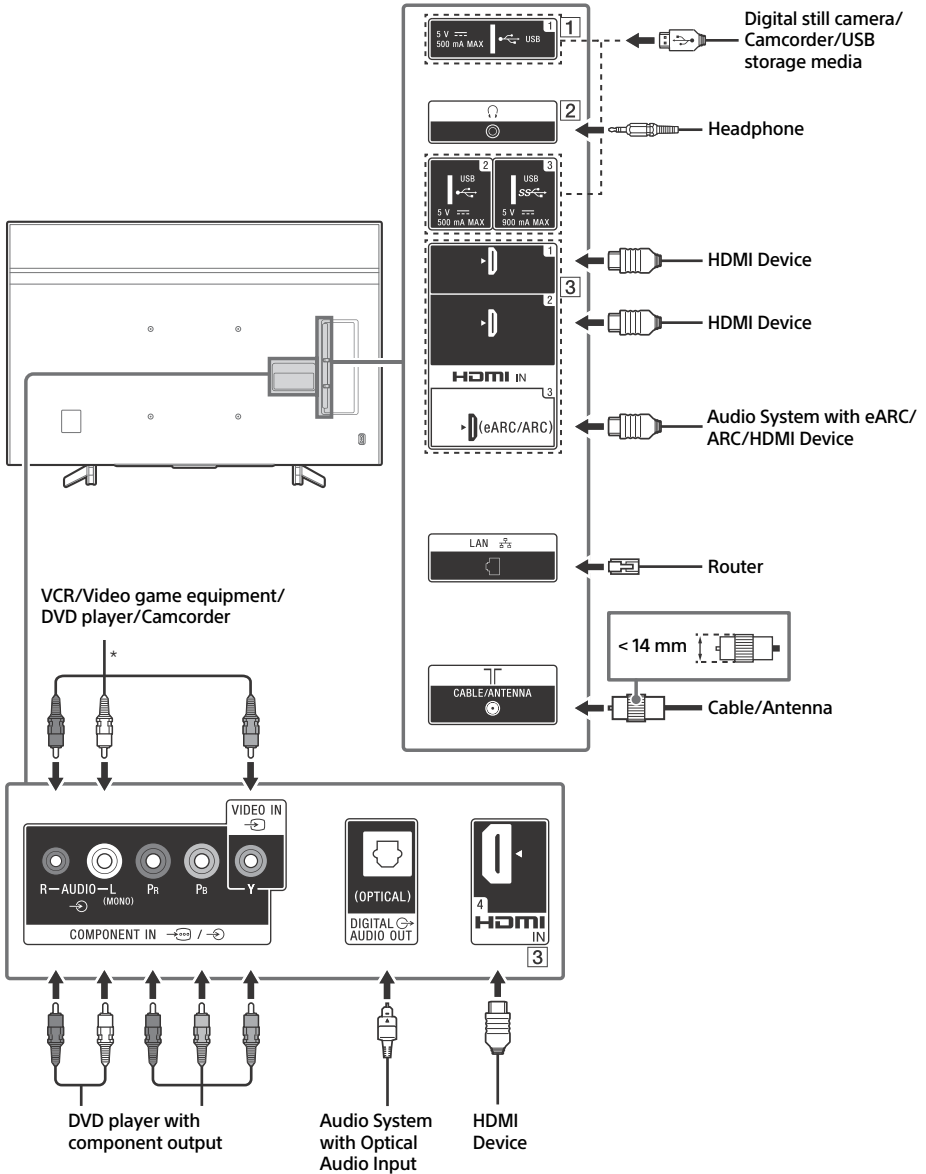

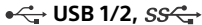
1  **USB 1/2, SS USB 3**

- Connecting a large USB device may interfere with other connected devices beside it.
- When connecting a large USB device, connect to the USB 1 port.

2  **(Headphone)**

- Supports 3-pole stereo mini jack only.
- You cannot output sound from both the headphone and the TV speakers at the same time.

3 **HDMI IN 1/2/3/4**

- HDMI interface can transfer the digital video and audio on a single cable.

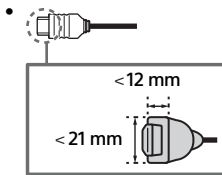

- To enjoy high quality 4K 50p/60p contents, connect a Premium High Speed HDMI cable and set the [HDMI signal format] to [Enhanced format]. Do this setting individually for each connected HDMI IN terminal. For details of supported formats, refer to the “Specifications” in this manual (page 13-14).

• **HDMI IN 3 eARC/ARC (Enhanced Audio Return Channel/Audio Return Channel)**

Connect your audio system to the HDMI IN 3 to route TV audio to your audio system. An audio system that supports HDMI eARC/ARC can send video to the TV, and receive audio from the TV via the same HDMI cable. If your audio system does not support HDMI eARC/ARC, an additional connection with DIGITAL AUDIO OUT (OPTICAL) is necessary.

- Use the HDMI cable with Ethernet to connect audio system with eARC.

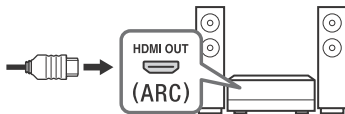

* When connecting mono equipment, connect to the L (MONO) audio jack (socket).

Installing the TV to the Wall

Using the optional Wall-Mount Bracket

This TV's instruction manual only provides the steps to prepare the TV for Wall-Mount installation before it is installed on the wall.

To Customers:

For product protection and safety reasons, Sony strongly recommends that installation of your TV be performed by Sony dealers or licensed contractors. Do not attempt to install it yourself.

To Sony Dealers and Contractors:

Provide full attention to safety during the installation, periodic maintenance and examination of this product.

Sufficient expertise is required for installing this product, especially to determine the strength of the wall for withstanding the TV's weight. Be sure to entrust the attachment of this product to the wall to Sony dealers or licensed contractors and pay adequate attention to safety during the installation. Sony is not liable for any damage or injury caused by mishandling or improper installation.

Use the Wall-Mount Bracket SU-WL450 (not supplied) to install the TV to the wall.

When installing the Wall-Mount Bracket, also refer to the Operating Instructions and Installation Guide supplied with the Wall-Mount Bracket.

Note

- Be sure to store the removed screws in a safe place, keeping them away from children.



For instructions on Wall-Mount Bracket installation, see the Installation Information (Wall-Mount Bracket) on the product page for your TV model.
<http://www.sony-asia.com/support>

Remove the screws from the rear of the TV.

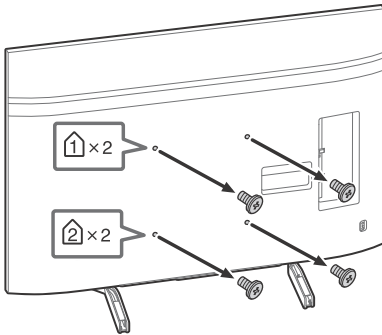

Detaching the Table-Top Stand from the TV

- 1 Remove one side of the Table-Top Stand at a time. Firmly hold the Table-Top Stand securely with both hands while the other people lift up the TV.

KD-85X8500G

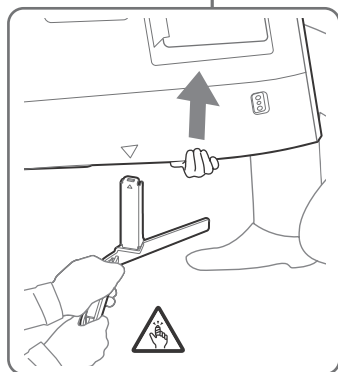
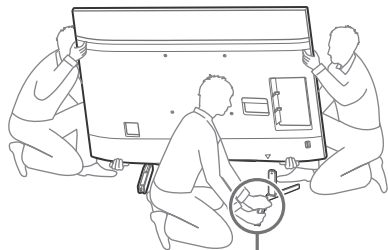

KD-75/65/55X8500G, KD-65/55X8577G

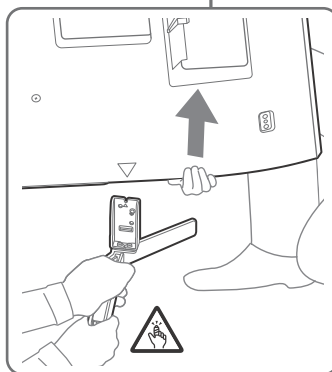
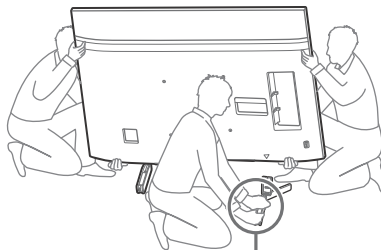

- 2 Repeat the previous step and remove the other side of the Table-Top Stand.

Note

- Three or more people are required to detach the Table-Top Stand.
- Be careful not to use excessive force while detaching the Table-Top Stand from the TV as it may cause the TV set to fall resulting in personal injury or physical damage to the TV.
- Take care when handling the Table-Top Stand to prevent damage to the TV.
- Be careful when lifting the TV as the Table-Top Stand is detached, the Table-Top Stand may topple over and cause personal injury.
- Take care when removing the Table-Top Stand from the TV to prevent it from falling over and damaging the surface that the TV is sitting on.

Troubleshooting

General troubleshooting for issues like: black screen, no sound, frozen picture, TV does not respond, or network is lost, do the following steps.

- 1 Restart your TV by pressing the power button on the remote control until a message appears. The TV will restart. If the TV does not recover, try unplugging the AC power cord (mains lead). Then press the power button on the TV and wait for two minutes, and plug in the AC power cord (mains lead).
- 2 Refer to the Help menu by pressing **HELP** on the remote control.
- 3 Connect your TV to the Internet and perform a software update. Sony recommends you to keep your TV software updated. Software updates provide new features and performance improvements.
- 4 Visit Sony support website (information provided on the front cover of this manual).

When you plug in the TV, the TV may not be able to turn on for a while even if you press the power button on the remote control or the TV.

It takes time to initialize the system. Wait for about one minute, then operate it again.

Troubles and Solutions

When the illumination LED is flashing in red.

- Count how many times it flashes (interval time is three seconds).
Reboot the TV by disconnecting the AC power cord (mains lead) until the illumination LED stopped flashing in red, then turn on the TV.
If the problem persists, disconnect the AC power cord (mains lead), and contact your dealer or Sony service centre with the number of times the illumination LED flashes.

There is no picture (screen is dark) and no sound.

- Check the antenna (aerial)/cable connection.
- Connect the TV to the AC power (mains), and press the power button on the TV or the remote control.

Some programmes cannot be tuned.

- Check the antenna (aerial)/cable connection.

The remote control does not function.

- Replace the batteries.

The parental lock for broadcast password has been forgotten.

- Enter 9999 for the PIN code and select [Change PIN code].

The TV surrounds become warm.

- When the TV is used for an extended period, the TV surrounds become warm. You may feel hot when touching there by the hand.

Specifications

System

Panel system

LCD (Liquid Crystal Display) Panel, LED Backlight

TV system

Depend on your country/area selection

Analogue: B/G, I, D/K, M

Digital: DVB-T/DVB-T2

Colour system

PAL/SECAM/NTSC3.58/NTSC4.43

Channel coverage

Depend on your country/area selection

Analogue: UHF/VHF/Cable

Digital: UHF/VHF

Sound output

10 W + 10 W

Wireless technology

Protocol IEEE802.11ac/a/b/g/n

(IEEE802.11ac may not be available depending on countries/regions.)

Bluetooth Version 4.2

Input/Output jacks

Antenna (aerial)/cable

75 ohm external terminal for VHF/UHF

COMPONENT IN

YPbPr (Component Video): 1080p (50, 60 Hz), 1080i (50, 60 Hz), 720p (50, 60 Hz), 576p, 576i, 480p, 480i

Audio input (phono pin jack)

VIDEO IN

Video input (common phono pin with Y input)

HDMI IN 1/2/3/4 (support 4K resolution, HDCP 2.3-compatible)

Video:

4096 × 2160p (50, 60 Hz)^{*1*2}, 4096 × 2160p (24 Hz)^{*1}, 3840 × 2160p (50, 60 Hz)^{*2}, 3840 × 2160p (24, 25, 30 Hz), 1080p (30, 50, 60 Hz), 1080/24p, 1080i (50, 60 Hz), 720p (30, 50, 60 Hz), 720/24p, 576p, 480p, PC Formats^{*3}

Audio:

In eARC (Enhanced Audio Return Channel) mode^{*4}

Refer to the Help Guide for details.

Except eARC mode

5.1 channel linear PCM: 32/44.1/48/88.2/96/176.4/192 kHz 16/20/24 bits, Dolby Digital, Dolby Digital Plus, DTS

eARC/ARC (Enhanced Audio Return Channel/ Audio Return Channel) (HDMI IN 3 only)

In eARC mode^{*4}

Refer to the Help Guide for details.

In ARC mode

Two channel linear PCM: 48 kHz 16 bits, Dolby Digital, Dolby Digital Plus, DTS

DIGITAL AUDIO OUT (OPTICAL)

Digital optical jack (Two channel linear PCM: 48 kHz 16 bits, Dolby Digital, DTS)

(Stereo mini jack)

Headphone

1, 2, 3

USB port 1 and 2 support High Speed USB (USB 2.0)

USB port 3 supports Super Speed USB (USB 3.1 Gen 1)

LAN

10BASE-T/100BASE-TX connector (Depending on the operating environment of the network, connection speed may differ. The communication rate and quality are not guaranteed.)

Others

Optional accessories

Wall-Mount Bracket: SU-WL450

Operating temperature

0 °C – 40 °C

Power and others

Power requirements

110 V – 240 V AC, 50/60 Hz

Energy Efficiency Class^{*5}

(For Egypt only)

KD-85X8500G: A

KD-65X8500G: A

KD-55X8500G: A

Screen size (measured diagonally) (Approx.)

KD-85X8500G: 85 inches / 214.8 cm

KD-75X8500G: 75 inches / 189.3 cm

KD-65X8577G / KD-65X8500G: 65 inches / 163.9 cm

KD-55X8577G / KD-55X8500G: 55 inches / 138.8 cm

Power consumption

Indicated on the rear of the TV

Power consumption*5

(For Egypt only)

In [Standard] mode

KD-85X8500G: 210.4 W

KD-65X8500G: 121.8 W

KD-55X8500G: 103.7 W

In [Vivid] mode

KD-85X8500G: 340 W

KD-65X8500G: 199 W

KD-55X8500G: 164 W

Annual energy consumption*5

(For Egypt only)*6

KD-85X8500G: 576 kWh per year

KD-65X8500G: 334 kWh per year

KD-55X8500G: 284 kWh per year

Standby power consumption*5*7*8

0.50 W

Display resolution

3,840 pixels (horizontal) × 2,160 lines (vertical)

Output Rating

USB 1/2

5 V $\overline{=}$, 500 mA MAX

USB 3

5 V $\overline{=}$, 900 mA MAX

Dimensions (Approx.) (w × h × d)

with Table-Top Stand

KD-85X8500G: 1,909 × 1,175 × 433 mm

KD-75X8500G: 1,673 × 1,031 × 358 mm

KD-65X8577G / KD-65X8500G: 1,450 × 899 × 316 mm

KD-55X8577G / KD-55X8500G: 1,231 × 776 × 316 mm

without Table-Top Stand

KD-85X8500G: 1,909 × 1,097 × 80 mm

KD-75X8500G: 1,673 × 963 × 54 mm

KD-65X8577G / KD-65X8500G: 1,450 × 836 × 52 mm

KD-55X8577G / KD-55X8500G: 1,231 × 713 × 52 mm

Mass (Approx.)

with Table-Top Stand

KD-85X8500G: 49 kg

KD-75X8500G: 39.3 kg

KD-65X8577G / KD-65X8500G: 26.3 kg

KD-55X8577G / KD-55X8500G: 19.7 kg

without Table-Top Stand

KD-85X8500G: 46.5 kg

KD-75X8500G: 37.8 kg

KD-65X8577G / KD-65X8500G: 25.3 kg

KD-55X8577G / KD-55X8500G: 18.7 kg

*1 When 4096 × 2160p is input and [Wide mode] is set to [Normal], the resolution is displayed as 3840 × 2160p. To display 4096 × 2160p, set [Wide mode] setting to [Full 1] or [Full 2].

*2 To support 18 Gbps, set [HDMI signal format] to [Enhanced format].

*3 Refer to the Help Guide for details.

*4 eARC mode is active when [eARC mode] is set to [Auto], [Speakers] is set to [Audio system] and eARC compatible audio system is connected.

*5 This information is for EU and other countries whose relevant regulation is based on EU energy labelling regulation.

*6 Energy consumption in kWh per year, based on the power consumption of the television operating 8 hours per day for 360 days. The actual energy consumption will depend on how the television is used.

*7 Specified standby power is reached after the TV finishes necessary internal processes.

*8 Standby power consumption will increase when your TV is connected to the network.

Note

- Optional accessories availability depends on countries/region/TV model/stock.
- Design and specifications are subject to change without notice.

Notes on Digital TV function

- Any functions related to Digital TV (DVB) will only work in countries or areas where DVB-T/DVB-T2 (MPEG-2 and H.264/MPEG-4 AVC) digital terrestrial signals are broadcast. Please confirm with your local dealer if you can receive a DVB-T/DVB-T2 signal where you live.
- This TV set complies with DVB-T/DVB-T2 specifications, but compatibility with future DVB-T/DVB-T2 digital terrestrial broadcasts are not guaranteed.
- Some Digital TV functions may not be available in some countries/areas.

Trademark information

- The terms HDMI and HDMI High-Definition Multimedia Interface, and the HDMI Logo are trademarks or registered trademarks of HDMI Licensing Administrator, Inc. in the United States and other countries.
- Dolby, Dolby Vision, Dolby Audio, and the double-D symbol are trademarks of Dolby Laboratories. Manufactured under license from Dolby Laboratories. Confidential unpublished works. Copyright © 1992-2015 Dolby Laboratories. All rights reserved.
- "BRAVIA", BRAVIA and BRAVIA Sync are trademarks or registered marks of Sony Corporation.

- Gracenote, the Gracenote logo and logotype, “Powered by Gracenote” logo are either registered trademarks or trademarks of Gracenote, Inc. in the United States and/ or other countries.
- Vewd® Core. Copyright 1995-2019 Vewd Software AS. All rights reserved.
- Google, Google Play, Chromecast, YouTube, Android TV and other related marks and logos are trademarks of Google LLC.
- Wi-Fi®, Wi-Fi Alliance® and Wi-Fi Direct® are registered trademarks of Wi-Fi Alliance.
- The Wi-Fi CERTIFIED™ Logo is a certification mark of Wi-Fi Alliance.
- For DTS patents, see <http://patents.dts.com>. Manufactured under license from DTS, Inc. DTS, the Symbol, & DTS and the Symbol together are registered trademarks, and DTS Digital Surround is a trademark of DTS, Inc. © DTS, Inc. All Rights Reserved.
- The Bluetooth® word mark and logos are registered trademarks owned by the Bluetooth SIG, Inc. and any use of such marks by Sony Corporation is under license. Other trademarks and trade names are those of their respective owners.
- Netflix is a registered trademark of Netflix, Inc.
- TUXERA is a registered trademark of Tuxera Inc. in the US and other countries.
- USB-IF SuperSpeed USB Trident logo is a registered trademark of USB Implementers Forum, Inc. 
- All other trademarks are the property of their respective owners.



| | | |
|---|--|------------|
| | | Help Guide |
| http://rd1.sony.net/help/tv/gga2/h_ga/ | | |

<http://www.sony.net/>

© 2019 Sony Visual Products Inc.