

SONY®

4-748-570-11(1)



Television

Reference Guide

GB

參考指南

CT



Customer Support and Contact:

用戶支援和聯絡:

<http://www.sony-asia.com/support>

BRAVIA

KD-49X9000G

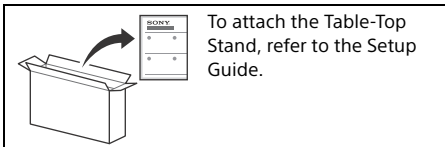

Introduction

Thank you for choosing this Sony product. Before operating the TV, please read this manual thoroughly and retain it for future reference.

Note

- Before operating the TV, please read the "Safety Information" (page 2).
- Read the supplied Safety Information for additional safety information.
- Instructions about "Installing the TV to the Wall" are included within this TV's instruction manual.
- Images and illustrations used in the Setup Guide and this manual are for reference only and may differ from the actual product.

Help

Find more troubleshooting and other useful information directly from your TV. Press **HELP** on the remote control to display a list of topics, or to search by keyword.

Help Guide (Manual)

For more detailed information, select [Help Guide] from the Help menu on your TV. You can also check the Help Guide from your PC or smartphone (information provided on the back cover of this manual).

Location of the identification label

Labels for the TV Model No. and Power Supply rating are located on the rear of the TV.

This television is designed for use in Hong Kong and ensured the usage in Hong Kong only.

Table of Contents

Safety Information	2
Parts and Controls	4
Controls and Indicators	4
Using Remote Control	5
Remote Control Parts Description	5
Connection Diagram	7
Installing the TV to the Wall	9
Using the optional Wall-Mount Bracket	9
Troubleshooting	10
Troubles and Solutions	10
Specifications	11

Safety Information

Installation/Set-up

Install and use the TV set in accordance with the instructions below in order to avoid any risk of fire, electric shock or damage and/or injuries.

Installation

- The TV set should be installed near an easily accessible AC power outlet (mains socket).
- Place the TV set on a stable, level surface to prevent it from falling over and causing personal injury or property damage.
- Install the TV where it cannot be pulled, pushed, or knocked over.
- Install the TV so that the TV's Table-Top Stand does not protrude out from the TV stand (not supplied). If the Table-Top Stand protrudes out from the TV stand, it may cause TV set to topple over, fall down, and cause personal injury or damage to the TV.

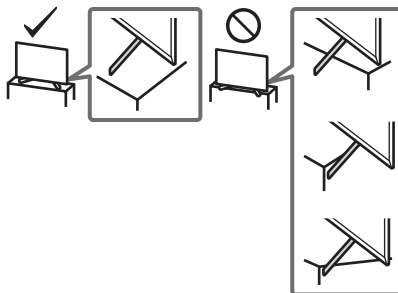

- Only qualified service personnel should carry out wall-mount installations.
- For safety reasons, it is strongly recommended that you use Sony accessories, including:
 - Wall-Mount Bracket SU-WL450
- Be sure to use the screws supplied with the Wall-Mount Bracket when attaching the Wall-Mount Bracket to the TV set. The supplied screws are designed as indicated by illustration when measured from the attaching surface of the Wall-Mount Bracket.

The diameter and length of the screws differ depending on the Wall-Mount Bracket model.

Use of screws other than those supplied may result in internal damage to the TV set or cause it to fall, etc.

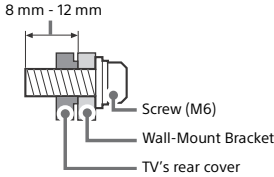

Transporting

- Before transporting the TV set, disconnect all cables.
- Two or three people are needed to transport a large TV set.
- When transporting the TV set by hand, hold it as shown below. Do not put stress on the LCD panel and the frame around the screen.

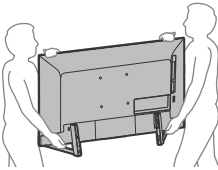

- When transporting the TV set, do not subject it to jolts or excessive vibration.
- When transporting the TV set for repairs or when moving, pack it using the original carton and packing material.

Topple prevention

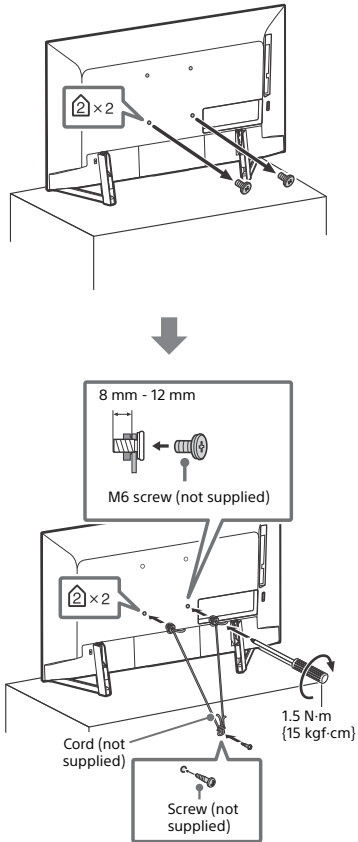

Parts and Controls

Controls and Indicators

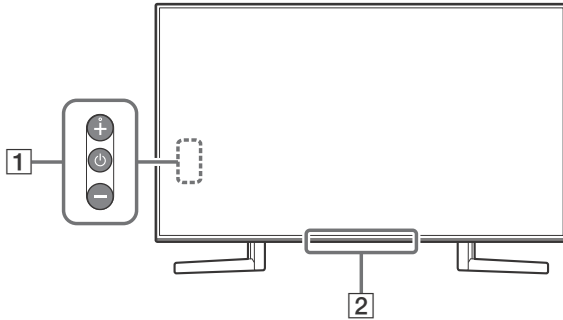



1 (Power) /+/-

When the TV is off,

Press  to power on.

When the TV is on,

Press and hold  to power off.

Press  repeatedly to change the function, then press + or - button to:

- Adjust the volume.
- Select the channel.
- Select the input source of TV.

2 **Remote Control sensor* / Light sensor* / Illumination LED**

The illumination LED lights up or blinks according to the status of the TV.

For more information, refer to the Help Guide.

* Do not place anything near the sensor.

Using Remote Control

Remote Control Parts Description

The remote control shape, location, availability and function of remote control buttons may vary depending on your region/country/TV model.

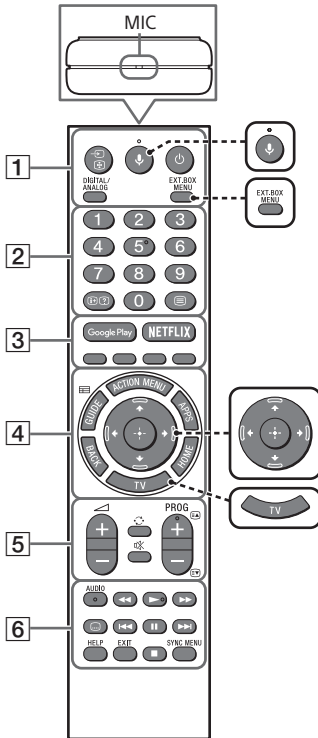



 **🗣️ (Microphone)**
Use voice search*. (e.g., Search various content by voice.)

 **EXT.BOX MENU**
Display the External Box (cable/satellite box) menu only if HDMI CEC compatible device is connected.

 **⬆️/⬇️/⬇️/⬆️/⬅️/➡️/➡️/➡️/➕ (Navigation D-Pad)**
On screen menu navigation and selection.

 **TV**
Switch to a TV channel or input and display the TV Menu Bar.

* The voice search requires an Internet connection.

- 1**  **(Input select/Text hold)**
In TV mode: Display and select the input source.
In Text mode: Hold the current page.
-  **(TV standby)**
Turn on or turn off the TV (standby mode).
- DIGITAL/ANALOG**
Switch between digital and analogue input.

2 **Number buttons**

-  **(Info/Text reveal)**
Display information.

-  **(Text)**
Display text information.

- 3** **Google Play**
Access the “Google Play” online service.

- NETFLIX (Only on limited region/country/TV model)**
Access the “NETFLIX” online service.

- Colour buttons**
Execute corresponding function at that time.

4 ACTION MENU

Display a list of contextual functions.

GUIDE

Display the digital programme guide.

APPS

Access various services and applications.

BACK

Return to the previous screen.

HOME

Display the TV Home Menu.

5 +/- (Volume)

Adjust the volume.

(Jump)



Jump back and forth between two channels or inputs. The TV alternates between the current channel or input and the last channel or input that was selected.

(Mute)

Mute the sound. Press again to restore the sound.

PROG +/-

In TV mode: Select the channel.

In Text mode: Select the next  or previous  page.

6 AUDIO

Select the sound of multilingual source or dual sound for the programme currently being viewed (depend on programme source).



Operate media contents on the TV and connected BRAVIA Sync-compatible device.

(Subtitle setting)

Turn subtitles on or off (when the feature is available).

HELP

Display the Help menu. Help Guide can be accessed from here.

EXIT

Return to the previous screen or exit from the menu. When an Interactive Application service is available, press to exit from the service.

SYNC MENU

Display the BRAVIA Sync Menu.

Connection Diagram

For more information on connections, refer to the Help Guide by pressing **HELP** on the remote control.

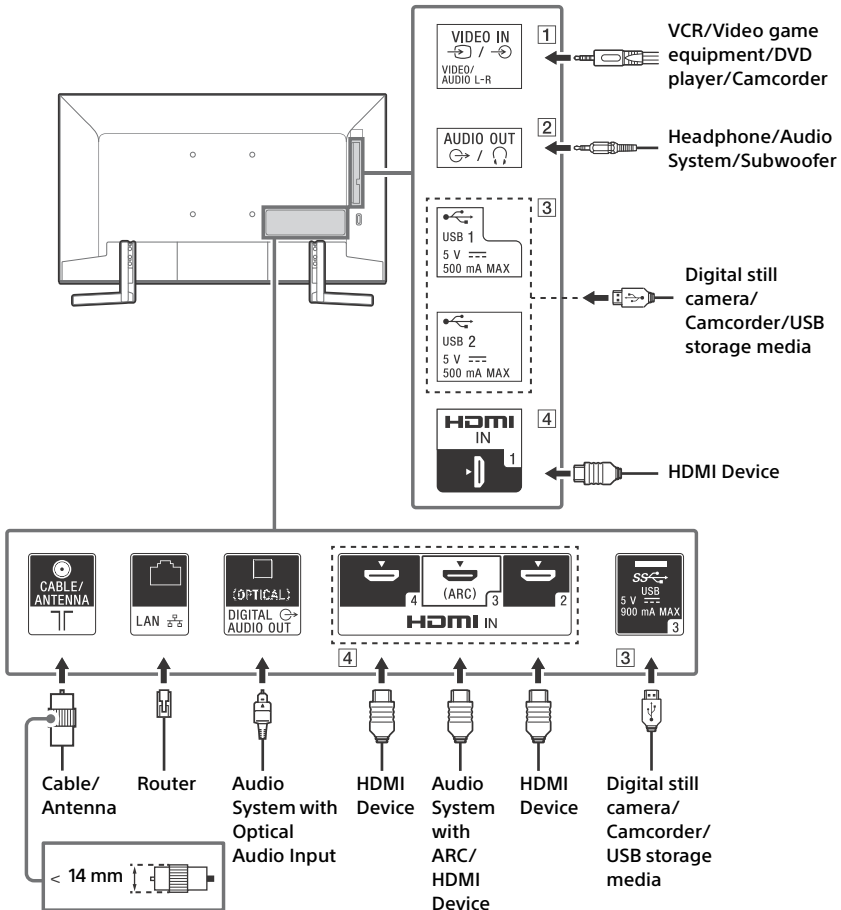

GB

1 VIDEO IN

- For a composite connection, use an Analogue Extension Cable (not supplied).

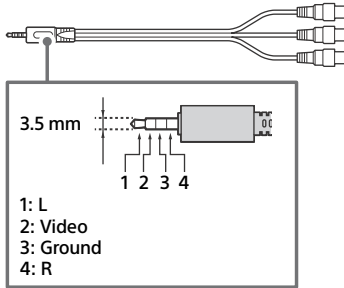

2 AUDIO OUT

- Supports 3-pole stereo mini jack only.
- To listen to the TV's sound through the connected equipment, press **HOME**. Select [Settings] → [Sound] → [Headphone/Audio out] and then select the desired item.

3 USB 1/2, USB 3

- Connecting a large USB device may interfere with other connected devices beside it.
- When connecting a large USB device, connect to the USB 1 port.

4 HDMI IN 1/2/3/4

- HDMI interface can transfer the digital video and audio on a single cable.

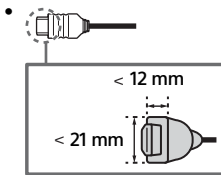

HDMI IN 2/3

To enjoy high quality 4K 50p/60p contents, connect a Premium High Speed HDMI cable to the HDMI IN 2/3 and set the [HDMI signal format] to [Enhanced format].

For details of supported formats, refer to the "Specifications" in this manual (page 11-12).

HDMI IN 3 ARC (Audio Return Channel)

Connect your audio system to the HDMI IN 3 to route TV audio to your audio system. An audio system that supports HDMI ARC can send video to the TV, and receive audio from the TV via the same HDMI cable. If your audio system does not support HDMI ARC, an additional connection with DIGITAL AUDIO OUT (OPTICAL) is necessary.



Installing the TV to the Wall

Using the optional Wall-Mount Bracket

This TV's instruction manual only provides the steps to prepare the TV for Wall-Mount installation before it is installed on the wall.

To Customers:

For product protection and safety reasons, Sony strongly recommends that installation of your TV be performed by Sony dealers or licensed contractors. Do not attempt to install it yourself.

GB

To Sony Dealers and Contractors:

Provide full attention to safety during the installation, periodic maintenance and examination of this product.

Sufficient expertise is required for installing this product, especially to determine the strength of the wall for withstanding the TV's weight. Be sure to entrust the attachment of this product to the wall to Sony dealers or licensed contractors and pay adequate attention to safety during the installation. Sony is not liable for any damage or injury caused by mishandling or improper installation.

Use the Wall-Mount Bracket SU-WL450 (not supplied) to install the TV to the wall. When installing the Wall-Mount Bracket, also refer to the Operating Instructions and Installation Guide supplied with the Wall-Mount Bracket.

Note

- Be sure to store the removed screws in a safe place, keeping them away from children.



For instructions on Wall-Mount Bracket installation, see the Installation Information (Wall-Mount Bracket) on the product page for your TV model.

<http://www.sony-asia.com/support>

Remove the screws from the rear of the TV.

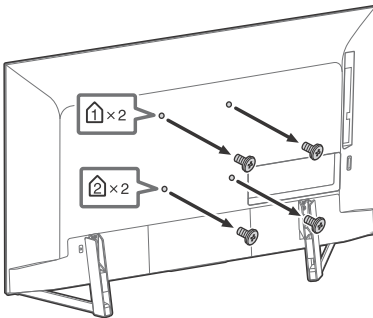

Troubleshooting

General troubleshooting for issues like: black screen, no sound, frozen picture, TV does not respond, or network is lost, do the following steps.

- 1 Restart your TV by pressing the power button on the remote control until a message appears. The TV will restart. If the TV does not recover, try unplugging the AC power cord (mains lead). Then press the power button on the TV and wait for two minutes, and plug in the AC power cord (mains lead).
- 2 Refer to the Help menu by pressing **HELP** on the remote control.
- 3 Connect your TV to the Internet and perform a software update. Sony recommends you to keep your TV software updated. Software updates provide new features and performance improvements.
- 4 Visit Sony support website (information provided on the front cover of this manual).

When [A new TV system software update is available...] message is displayed.

Sony strongly recommends you to update the TV software by selecting [Update Now]. These software updates improve your TV performance or add new features.

The following screen with [Updating...] will appear and the illumination LED flashes white while software is updating.

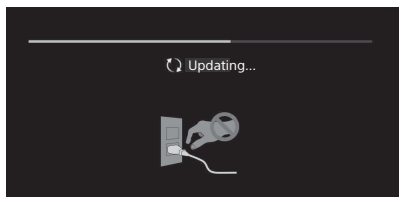

Do not unplug the AC power cord (mains lead) during the software update. If you do, the software update may not finish completely, and it may cause a software malfunction. Software updates can take up to 15 minutes.

When you plug in the TV, the TV may not be able to turn on for a while even if you press the power button on the remote control or the TV.

It takes time to initialize the system. Wait for about one minute, then operate it again.

Troubles and Solutions

When the illumination LED is flashing in red.

- Count how many times it flashes (interval time is three seconds).
Reboot the TV by disconnecting the AC power cord (mains lead) until the illumination LED stopped flashing in red, then turn on the TV. If the problem persists, disconnect the AC power cord (mains lead), and contact your dealer or Sony service centre with the number of times the illumination LED flashes.

There is no picture (screen is dark) and no sound.

- Check the antenna (aerial)/cable connection.
- Connect the TV to the AC power (mains), and press the power button on the TV or the remote control.

Some programmes cannot be tuned.

- Check the antenna (aerial)/cable connection.

The remote control does not function.

- Replace the batteries.

The EXT.BOX MENU button on the remote control does not work.

- Connect HDMI CEC compatible device and change to that input.

The parental lock for broadcast password has been forgotten.

- Enter 9999 for the PIN code and select [Change PIN code].

The TV surrounds become warm.

- When the TV is used for an extended period, the TV surrounds become warm. You may feel hot when touching there by the hand.

Specifications

System

Panel system

LCD (Liquid Crystal Display) Panel, LED Backlight

TV system

Analogue: I, D/K, B/G, M

Digital: DTMB

Colour system

PAL/SECAM/NTSC3.58/NTSC4.43

Channel coverage

Analogue: UHF/VHF/Cable

Digital: UHF

Sound output

10 W + 10 W

Wireless technology

Protocol IEEE802.11ac/a/b/g/n

Bluetooth Version 4.1

Input/Output jacks

Antenna (aerial)/cable

75 ohm external terminal for VHF/UHF

VIDEO IN

Video/Audio input (mini jack)

HDMI IN 1/2/3/4 (support 4K resolution,

HDCP 2.3-compatible)

Video:

4096 × 2160p (50, 60 Hz)^{*1*}, 4096 × 2160p (24 Hz)^{*1}, 3840 × 2160p (50, 60 Hz)^{*2}, 3840 × 2160p (24, 25, 30 Hz), 1080p (30, 50, 60 Hz), 1080i (50, 60 Hz), 720p (30, 50, 60 Hz), 720i (50, 60 Hz), 480p, 480i, PC Formats^{*3}

Audio:

5.1 channel linear PCM: 32/44.1/48/88.2/96/176.4/192 kHz 16/20/24 bits, Dolby Digital, Dolby Digital Plus and DTS

ARC (Audio Return Channel) (HDMI IN 3 only)

(Two channel linear PCM: 48 kHz 16 bits, Dolby Digital, Dolby Digital Plus, DTS)

DIGITAL AUDIO OUT (OPTICAL)

Digital optical jack (Two channel linear PCM: 48 kHz 16 bits, Dolby Digital, DTS)

AUDIO OUT (Stereo mini jack)

Headphone, Audio output, Subwoofer

USB 1, 2, 3

USB port 1 and 2 support High Speed USB (USB 2.0).

USB port 3 supports Super Speed USB (USB 3.1 Gen 1)

LAN

10BASE-T/100BASE-TX connector (Depending on the operating environment of the network, connection speed may differ. The communication rate and quality are not guaranteed.)

Others

Optional accessories

Wall-Mount Bracket: SU-WL450

Operating temperature

0 °C – 40 °C

Operating humidity

10 % – 80 % RH (non-condensing)

Power and others

Power requirements

220 V - 240 V AC, 50 Hz

Screen size (measured diagonally) (Approx.)

49 inches / 123.2 cm

Power consumption

Indicated on the rear of the TV

Standby power consumption^{*4*}

0.5 W

Display resolution

3,840 pixels (horizontal) × 2,160 lines (vertical)

Output Rating

USB 1/2

5 V ---, 500 mA MAX

USB 3

5 V ---, 900 mA MAX

Dimensions (Approx.) (w × h × d)

with Table-Top Stand

1093 × 699 × 274 mm

without Table-Top Stand

1093 × 629 × 69 mm

Mass (Approx.)

with Table-Top Stand

14.6 kg

without Table-Top Stand

13.5 kg

^{*1} When 4096 × 2160p is input and [Wide mode] is set to [Normal], the resolution is displayed as 3840 × 2160p. To display 4096 × 2160p, set [Wide mode] setting to [Full 1] or [Full 2].

^{*2} HDMI IN 2/3 only. To support 18 Gbps, set [HDMI signal format] to [Enhanced format].

^{*3} Refer to the Help Guide for details.

^{*4} Specified standby power is reached after the TV finishes necessary internal processes.

^{*5} Standby power consumption will increase when your TV is connected to the network.

Note

- Optional accessories availability depends on countries/region/TV model/stock.
- Design and specifications are subject to change without notice.

Trademark information

- The terms HDMI and HDMI High-Definition Multimedia Interface, and the HDMI Logo are trademarks or registered trademarks of HDMI Licensing Administrator, Inc. in the United States and other countries.
- Dolby, Dolby Vision, Dolby Audio, and the double-D symbol are trademarks of Dolby Laboratories. Manufactured under license from Dolby Laboratories. Confidential unpublished works. Copyright ©1992-2015 Dolby Laboratories. All rights reserved.
- "BRAVIA", BRAVIA and BRAVIA Sync are trademarks or registered marks of Sony Corporation.
- Gracenote, the Gracenote logo and logotype, "Powered by Gracenote" logo are either registered trademarks or trademarks of Gracenote, Inc. in the United States and/or other countries.
- Vewd® Core. Copyright 1995-2019 Vewd Software AS. All rights reserved.
- Google, Google Play, Chromecast, YouTube, Android TV and other related marks and logos are trademarks of Google LLC.
- Wi-Fi®, Wi-Fi Alliance®, Wi-Fi Direct® and Miracast® are registered trademarks of Wi-Fi Alliance.
- The Wi-Fi CERTIFIED™ Logo is a certification mark of Wi-Fi Alliance.
- For DTS patents, see <http://patents.dts.com>. Manufactured under license from DTS, Inc. DTS, the Symbol, & DTS and the Symbol together are registered trademarks, and DTS Digital Surround is a trademark of DTS, Inc. © DTS, Inc. All Rights Reserved.
- The Bluetooth® word mark and logos are registered trademarks owned by the Bluetooth SIG, Inc. and any use of such marks by Sony Corporation is under license. Other trademarks and trade names are those of their respective owners.
- RealMedia © 2018 RealNetworks, Inc. All rights reserved. RealMedia, RealNetworks, and their logos are trademarks or registered trademarks of RealNetworks, Inc.
- Netflix is a registered trademark of Netflix, Inc.
- TUXERA is a registered trademark of Tuxera Inc. in the US and other countries.
- USB-IF SuperSpeed USB Trident logo is a registered trademark of USB Implementers Forum, Inc. 
- All other trademarks are the property of their respective owners.

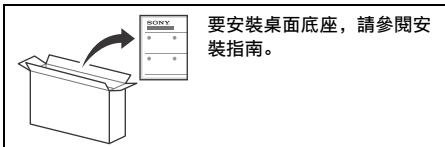

簡介

感謝您購買這項 Sony 產品。
使用電視機之前，請詳閱本手冊，並保留下來以便將來參考。

註

- 使用電視機之前，請詳讀“安全資訊”(第 2 頁)。
- 有關其他安全資訊，請閱讀隨附的安全資訊。
- 有關“將電視機安裝在牆上”的指示已包含在這台電視機的使用說明書。
- 安裝指南和本說明書中使用的影像和插圖僅作參考並可能與實際產品不同。

說明

直接從電視機獲取更多故障排除資訊和其他有用資訊。按遙控器上的 **HELP** 以顯示主題清單，或透過關鍵字搜尋。

說明指南 (說明書)

有關更多资讯，請從電視機上的說明選單選擇 [說明指南]。您也可以從您的 PC 或智能手機查看說明指南 (本說明書封底提供的資訊)。

識別標籤的位置

電視機型號和電源等級的標籤位於電視機背面。

本電視設計在香港使用，只保證能在香港使用。

安全資訊

安裝 / 設定

為了避免火災、觸電或損壞及 / 或受傷等危險，請遵照下列指示來安裝和使用電視機。

安裝

- 應將電視機安裝在易於插拔的 AC 電源插座附近。
- 將電視機放在一個穩定的平面，以防止墜落和引起個人傷害或財產損壞。
- 應將電視機安裝在不容易被拉、推或碰倒之處。
- 安裝電視機，使電視機的桌面底座不會從電視機櫃 (非附帶) 凸出。如果桌面底座從電視機櫃凸出，可能導致電視機翻倒、掉落及人身傷害或對電視機造成損壞。

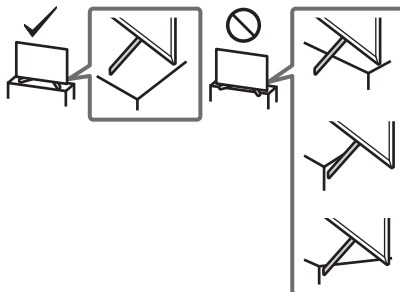

- 僅可由合格的維修人員執行掛壁安裝。
- 為了安全起見，強烈建議您使用 Sony 配件，包括：
 - 壁掛式支架 SU-WL450

目錄

安全資訊	2
組件及控件	4
控件及指示燈	4
使用遙控器	5
遙控器組件說明	5
連接圖	7
將電視機安裝在牆上	9
使用選購的壁掛式支架	9
故障排除	10
故障及解決方案	10
規格	11

- 將掛鉤（底座）/ 壁掛式支架安裝於電視機上時，務必要使用隨附於壁掛式支架的螺絲。
隨附螺絲如插圖所示設計從掛鉤（底座）/ 壁掛式支架安裝表面量起。
螺絲的直徑和長度會因為壁掛式支架的型號而有所不同。
使用隨附螺絲以外的螺絲可能會造成電視機內部損壞或者掉落等等。

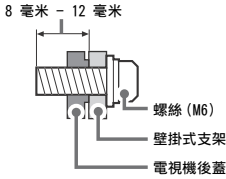

防止傾倒

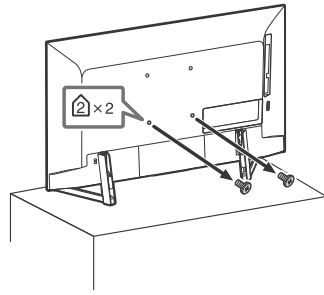

搬動

- 搬動電視機之前，請斷開所有纜線的連接。
- 大尺寸電視機需要兩到三人搬動。
- 用手搬動電視機時，請如下圖所示抓握。請勿對液晶面板以及螢幕周圍的框邊施加壓力。

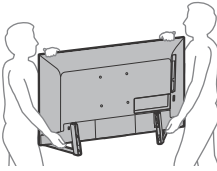

- 搬動電視機時，請勿使其受到搖晃或過度震動。
- 搬動電視機以進行維修或移動時，請使用原有的紙箱和包裝材料進行包裝。

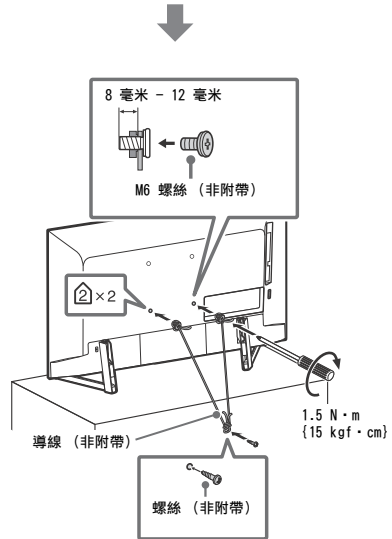

組件及控件

控件及指示燈

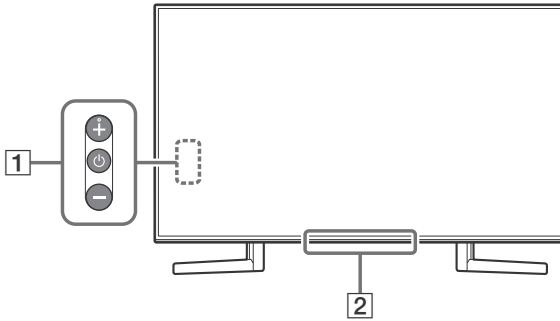

1 ⏻ (電源) /+/-

當電視機處於關機狀態時，

請按 ⏻ 開機。

打開電視機時，

按住 ⏻ 關機。

重複按 ⏻ 以變更功能，然後按 + 或 - 按鈕

執行下列操作：

- 調節音量。
- 選擇頻道。
- 選擇電視機輸入源。

2 遙控器感應器 * / 光感應器 * / 照明 LED

根據電視機的狀態，照明 LED 會亮起或閃爍。
有關更多資訊，請參閱說明指南。

*請勿在感應器附近放置任何物品。

使用遙控器

遙控器組件說明

遙控器外形、按鈕的位置、可用性與功能視您的國家 / 區域 / 電視機型號而可能略有不同。

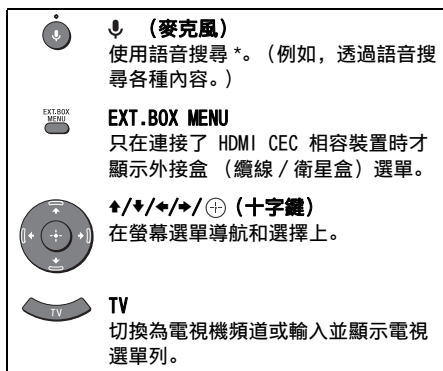
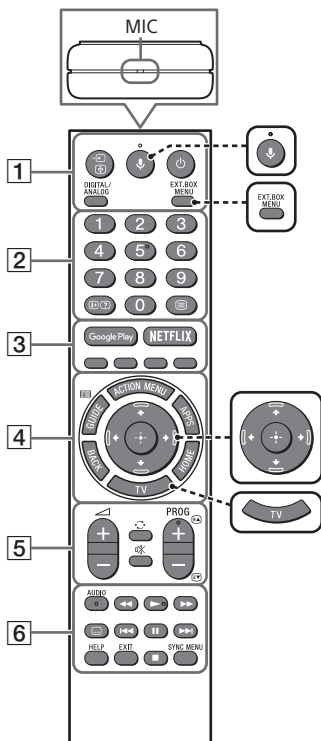

*語音搜尋需要網路連線。

- 1** (輸入選擇 / 文字保留)
電視模式：顯示並選擇輸入來源。
文字模式：保留當前頁面。

(電視待機)
開啟或關閉電視機 (待機模式)。

DIGITAL/ANALOG
在數位及模擬輸入之間切換。

- 2** **數字按鈕**

(顯示資訊 / 文字)
顯示資訊。

(文字)
顯示文字資訊。

- 3** **Google Play**
訪問“Google Play”線上服務。

NETFLIX (僅限限制的區域 / 國家 / 電視機型號)
訪問“NETFLIX”線上服務。

顏色按鈕
屆時執行相應的功能。

4 ACTION MENU

顯示情境功能清單。

GUIDE 

顯示數位節目指南。

APPS

訪問各種服務和應用程式。

BACK

返回上一個畫面。

HOME

顯示電視主選單。

5 +/- (音量)



調節音量。

 (跳轉)



在兩個頻道或兩次輸入之間前後跳轉。電視在當前頻道 / 輸入以及選擇的上一個頻道 / 輸入之間交替切換。

 (靜音)

將聲音消除。再次按下可恢復聲音。

PROG +/-  

電視模式：選擇頻道。

文字模式：選擇下一個 () 或上一個 () 頁面。

6 AUDIO

為當前正在觀看的節目選擇多語言聲源或雙聲道（取決於節目源）。



運行電視機和相連的 BRAVIA Sync 相容裝置上操作媒體內容。

 (字幕設定)

開啟或關閉字幕（此功能可用時）。

HELP

顯示說明選單。可以從此處訪問說明指南。

EXIT

返回至上一個畫面，或從選單退出。如果交互式應用服務可供使用，按下即可退出服務。

SYNC MENU

顯示 BRAVIA 同步選單。

連接圖

有關連接的更多資訊，請按遙控器上的 **HELP** 以參閱說明指南。

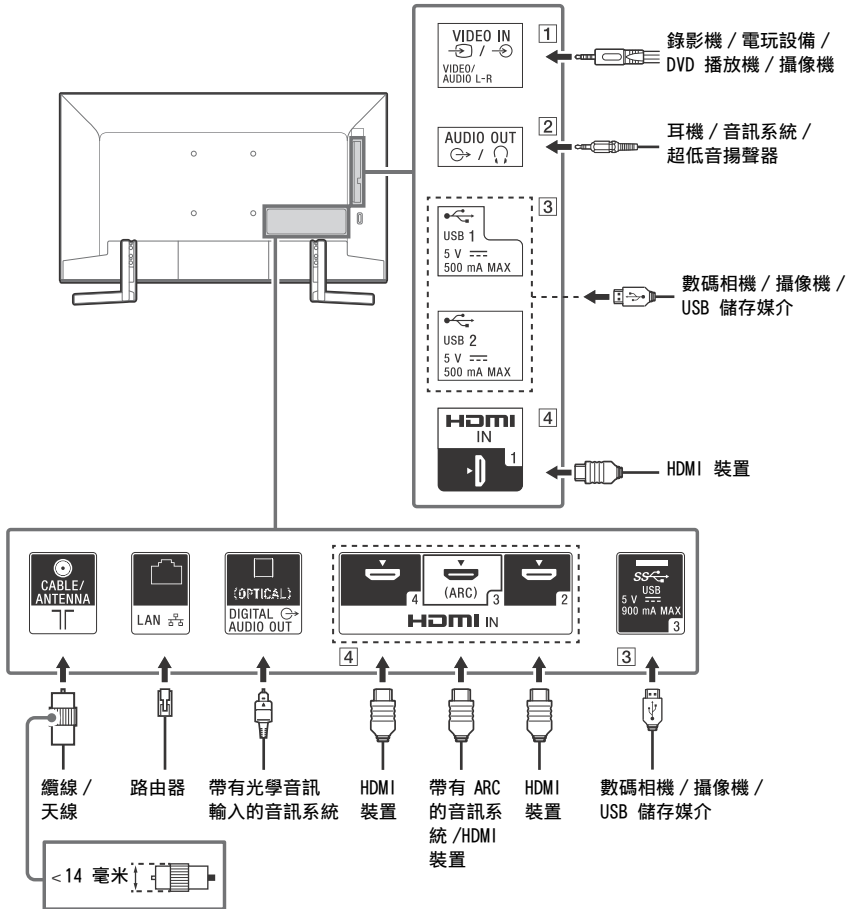

1 VIDEO IN

- 如需完成複合連接，請使用模擬延長纜線（非附帶）。

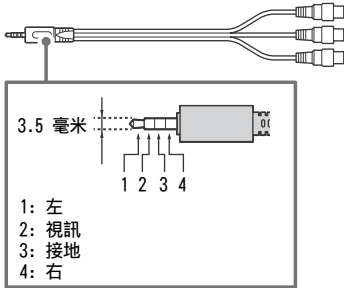

2 AUDIO OUT

- 僅支援 3 極立體聲聲迷你插孔。
- 如需透過相連設備聆聽電視聲音，請按 HOME。選擇 [設定] → [音效] → [耳機 / 音訊輸出]，並選擇所需的項目。

3 USB 1/2, USB 3

- 連接大型 USB 裝置可能會干擾旁邊連接的其他裝置。
- 連接大型 USB 裝置時，請連接至 USB 1 埠。

4 HDMI IN 1/2/3/4

- HDMI 介面可使用單個纜線傳輸數位視訊和音訊。

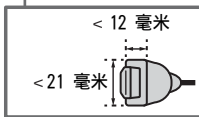

HDMI IN 2/3

要享受高品質 4K 50p/60p 內容，將優質速度 HDMI 接線連結至 HDMI IN 2/3，並將 [HDMI 訊號格式] 設定至 [增強格式]。有關支援格式的細節，請參考本手冊（第 11-12 頁）的“規格”。

• HDMI IN 3 ARC (Audio Return Channel)

將音訊系統連接至 HDMI IN 3 以傳送電視機音訊至音訊系統。支援 HDMI ARC 的音訊系統可將視訊傳送至電視機，並透過同一 HDMI 纜線從電視機接收音訊。如果音訊系統不支援 HDMI ARC，必須額外連接 DIGITAL AUDIO OUT (OPTICAL)。

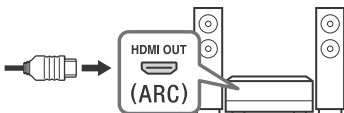

將電視機安裝在牆上

使用選購的壁掛式支架

本電視機使用說明書僅提供將電視機安裝到牆上前準備電視機進行壁掛式安裝的步驟。

致客戶：

出於產品保護及安全原因，Sony 強烈建議由 Sony 經銷商或授權的承包商安裝電視機。請勿嘗試自行安裝電視機。

致 Sony 經銷商和承包商：

安裝、定期維護及檢查本產品時，請充分注意安全。

安裝本產品須具備充足的專業知識，確定牆壁是否能夠承受電視重量時尤為如此。務必委託 Sony 經銷商或授權的承包商將本產品安裝至牆壁上，並在安裝期間充分注意安全。對於因錯誤操作或安裝不當引致的任何損害，Sony 概不負責。

使用壁掛式支架 SU-WL450（非附帶）將電視機安裝到牆上。
安裝壁掛式支架時，亦請參閱壁掛式支架附帶的使用說明書及安裝指南。

註

- 務必將取下的螺絲存放在兒童接觸不到的安全位置。



有關壁掛式支架安裝的說明，請參閱您的電視機型號的產品頁上的安裝訊息（壁掛式支架）。
<http://www.sony-asia.com/support>

從電視機背面卸下螺絲。

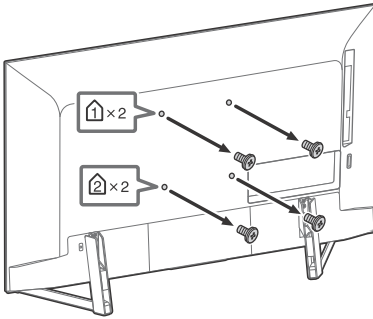

故障排除

以下問題的一般故障排除：黑螢幕、沒有聲音、凍結畫面、電視機沒有反應或網絡丟失，請依照以下步驟操作。

- 1 按遙控器上的電源按鈕重新啟動電視機，直到顯示一則訊息。電視機將重新啟動。如果電視機未恢復正常，請嘗試拔下 AC 電源線。然後按電視機上的電源按鈕，等待兩分鐘，再將 AC 電源線插入。
- 2 請按遙控器上的 **HELP** 以參閱說明選單。
- 3 將電視機連接至網路，然後執行軟體更新。
Sony 建議您持續更新電視機軟體。軟體更新會提供新功能和性能改善。
- 4 造訪 Sony 服務網站（本手冊封面提供的資訊）。

當顯示 [有新的電視系統軟件更新可用 ...] 訊息時。

Sony 強烈建議您選擇 [立即更新] 更新電視機軟體。這些軟體更新會改善電視機效能或加入新功能。

將顯示以下 [Updating...]（正在更新...）的螢幕，照明 LED 在軟體更新期間閃白燈。

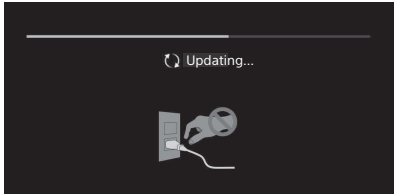

軟體更新期間，請勿拔出 AC 電源線。否則，軟體更新不會徹底完成，並且可能引致軟體故障。軟體更新可能持續長達 15 分鐘。

在插入電視機時，即使按遙控器或電視機上的電源按鈕，電視機也可能在一定時間不能開啟。

系統初始化需要一定時間。等待大約一分鐘，然後再次操作。

故障及解決方案

當照明 LED 閃爍紅燈時。

- 統計該照明 LED 閃爍的次數（間隔時間為三秒）。斷開 AC 電源線直到照明 LED 停止閃爍紅燈來重新啟動電視機，然後開啟電視機。
如果此問題仍然存在，請斷開 AC 電源線，然後聯絡您的經銷商或 Sony 服務中心並告知照明 LED 閃爍的次數。

沒有畫面（螢幕是黑的）也沒有聲音。

- 檢查天線 / 訊號線連接。
- 將電視機連接至 AC 電源，然後按電視機或遙控器上的電源按鈕。

無法調諧某些節目。

- 檢查天線 / 訊號線連接。

遙控器無效。

- 更換電池。

遙控器上的 EXT. BOX MENU 按鈕不工作。

- 連接 HDMI CEC 相容裝置並更改至該輸入。

忘記廣播密碼的家長鎖定。

- PIN 碼輸入 9999，然後選擇 [變更 PIN 號碼]。

電視機周圍溫度升高。

- 當長時間使用電視機時，電視機周圍溫度會升高。用手觸摸這些地方時可能會覺得很燙。

規格

系統

面板系統

LCD (液晶顯示) 面板, LED 背光源

電視系統

模擬: I, D/K, B/G, M

數位: DTMB

彩色系統

PAL/SECAM/NTSC3.58/NTSC4.43

頻道涵蓋範圍

模擬: UHF/VHF/ 纜線

數位: UHF

聲音輸出

10 瓦 + 10 瓦

無線技術

IEEE802.11ac/a/b/g/n 協議

藍牙版本 4.1

輸入 / 輸出插孔

天線 / 纜線

VHF/UHF 的 75 歐姆外接端子

VIDEO IN

視訊 / 音訊輸入 (迷你插孔)

HDMI IN 1/2/3/4 (支援 4K 解析度、HDCP 2.3 相容)

視訊:

4096 × 2160p (50, 60 Hz)^{*1*2}, 4096 × 2160p

(24 Hz)^{*1}, 3840 × 2160p (50, 60 Hz)^{*2},

3840 × 2160p (24, 25, 30 Hz),

1080p (30, 50, 60 Hz), 1080/24p, 1080i

(50, 60 Hz), 720p (30, 50, 60 Hz),

720/24p, 576p, 576i, 480p, 480i, PC 格式^{*3}

音訊:

5.1 聲道線性 PCM: 32/44.1/48/88.2/96/176.4/

192 kHz 16/20/24 位元, Dolby Digital, Dolby

Digital Plus 和 DTS

ARC (Audio Return Channel) (僅限 HDMI IN 3)

(兩聲道線性 PCM: 48 kHz 16 位元, Dolby

Digital, Dolby Digital Plus 和 DTS)

DIGITAL AUDIO OUT (OPTICAL)

數位光纖插孔 (兩聲道線性 PCM: 48 kHz 16 位元,

Dolby Digital 和 DTS)

AUDIO OUT (立體聲迷你插孔)

耳機、音訊輸出、超低音揚聲器

USB 1, 2, SS

USB 連接埠 1 和 2 支援高速 USB (USB 2.0)

USB 連接埠 3 支援超快速 USB (USB 3.1 Gen 1)

LAN

10BASE-T/100BASE-TX 接頭 (視網絡的作業環境而定, 連線速度可能不同。不保證通訊率和通訊品質。)

其他

選用的配件

壁掛式支架: SU-WL450

作業溫度

0 °C - 40 °C

操作溫度

10 % - 80 % 相對濕度 (非冷凝)

電源和其他規格

電源需求

220 V - 240 V AC, 50 Hz

螢幕尺寸 (對角測量) (大約)

49 英寸 / 123.2 厘米

耗電量

見電視機背面

待機耗電量^{*4*5}

0.5 瓦

顯示解析度

3840 畫素 (水平) × 2160 條線 (垂直)

輸出率

USB 1/2

5 V ---, 500 mA 最大值

USB 3

5 V ---, 900 mA 最大值

尺寸 (大約) (寬 × 高 × 深)

包含桌面底座

1093 × 699 × 274 毫米

不含桌面底座

1093 × 629 × 69 毫米

重量 (大約)

包含桌面底座

14.6 千克

不含桌面底座

13.5 千克

*1 當輸入 4096 × 2160p 且 [寬螢幕模式] 設為 [正常模式] 時, 解析度將顯示為 3840 × 2160p。要顯示 4096 × 2160p, 請將 [寬螢幕模式] 設定設為 [全螢幕模式 1] 或 [全螢幕模式 2]。

*2 僅限 HDMI IN 2/3。若要支援 18 Gbps, 將 [HDMI 訊號格式] 設定為 [增強格式]。

*3 有關詳情, 請參閱說明指南。

*4 電視完成必要的內部處理程序之後會達到指定的待機電力。

*5 在電視連接網路時, 待機耗電量會增加。

註

- 選購配件的供應視國家 / 區域 / 電視機型號 / 存貨而定。
- 設計與規格可能變更而不事先通知。

商標資訊

- HDMI、HDMI 高畫質多媒體介面及 HDMI 標誌為 HDMI Licensing Administrator, Inc. 在美國及其他國家的商標或註冊商標。
- Dolby、杜比、Dolby Vision、Dolby Audio、和雙 D 符號是杜比實驗室的商標。本產品經過杜比實驗室的許可而製造。未公佈的機密作品。版權所有 © 1992–2015 杜比實驗室。保留所有權利。
- “BRAVIA”、BRAVIA 和 BRAVIA Sync 是 Sony Corporation 的商標或註冊商標。
- Gracenote、Gracenote 標誌和標誌字型以及 “Powered by Gracenote” 標誌是 Gracenote, Inc. 在美國和 / 或其他國家的註冊商標或商標。
- Vewd® Core. Copyright 1995–2019 Vewd Software AS. All rights reserved.
- Google、Google Play、Chromecast、YouTube、Android TV 和其他相關標記和徽標是 Google LLC 的商標。
- Wi-Fi®、Wi-Fi Alliance®、Wi-Fi Direct® 和 Miracast® 是 Wi-Fi Alliance 的註冊商標。
- Wi-Fi CERTIFIED™ 標誌是 Wi-Fi Alliance 的認證標誌。
- 有關 DTS 專利，請參閱 <http://patents.dts.com>。由 DTS, Inc. 授權製造。DTS、其標誌、& DTS 連同其標誌是註冊商標，而 DTS Digital Surround 是 DTS, Inc. 的商標。© DTS, Inc. 保留所有權利。
- 藍牙® 文字標記和徽標是 Bluetooth SIG, Inc. 持有的註冊商標，任何使用此商標的 Sony Corporation 均需獲得授權。其他商標和商標名稱為各自所有者的商標和商名。
- RealMedia © 2018 RealNetworks, Inc. 保留所有權利。RealMedia, RealNetworks 以及它們的標誌是 RealNetworks, Inc. 的商標或註冊商標。
- Netflix 是 Netflix, Inc. 的註冊商標。
- TUXERA 是 Tuxera Inc. 在美國及其他國家 / 地區的註冊商標。
- USB-IF SuperSpeed USB Trident 標誌是 USB Implementers Forum, Inc. 的註冊商標。

- 所有其他商標屬於其各自的所有者。



Help Guide
説明指南

http://rd1.sony.net/help/tv/gga1/h_ga/

<http://www.sony.net/>

© 2019 Sony Visual Products Inc. Printed in Japan