

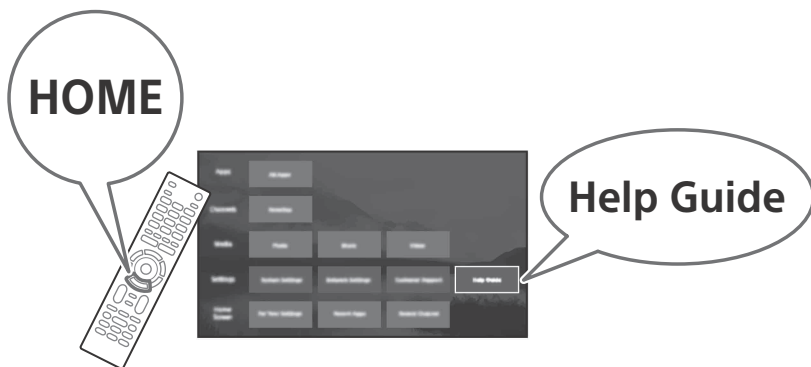



## Television

### Reference Guide



 Customer Support and Contact:  
<http://www.sony-asia.com/support>

## BRAVIA

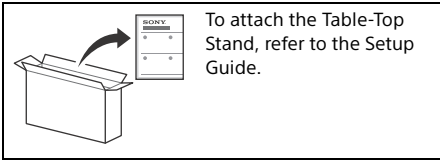

# Table of Contents

- Safety Information . . . . . 2
- Parts and Controls . . . . . 4
  - Controls and Indicators . . . . . 4
- Using Remote Control . . . . . 5
  - Remote Control Parts Description . . . . . 5
- Connection Diagram . . . . . 7
- Installing the TV to the Wall . . . . . 9
- Troubleshooting . . . . . 11
  - Troubles and Solutions . . . . . 11
- Specifications . . . . . 11

## Introduction

Thank you for choosing this Sony product. Before operating the TV, please read this manual thoroughly and retain it for future reference.

### Note

- Before operating the TV, please read the "Safety Information" (page 2).
- Read the supplied Safety Information for additional safety information.
- Instructions about "Installing the TV to the Wall" are included within this TV's instruction manual.
- Images and illustrations used in the Setup Guide and this manual are for reference only and may differ from the actual product.

### Help Guide (Manual)

For more detailed information, press **HOME** on the remote control, then select [Help Guide] under [Settings] menu. You can also check the Help Guide from your PC or smartphone (information provided on the back cover of this manual).

### Location of the identification label

Labels for the TV Model No. and Power Supply rating are located on the rear of the TV.

For models with supplied AC adapter:

Labels for AC adapter Model No. and Serial No. are located at the bottom of AC adapter.

## Safety Information

### Installation/Set-up

Install and use the TV set in accordance with the instructions below in order to avoid any risk of fire, electric shock or damage and/or injuries.

#### Installation

- The TV set should be installed near an easily accessible AC power outlet (mains socket).
- Place the TV set on a stable, level surface to prevent it from falling over and causing personal injury or property damage.
- Install the TV where it cannot be pulled, pushed, or knocked over.
- Install the TV so that the TV's Table-Top Stand does not protrude out from the TV stand (not supplied). If the Table-Top Stand protrudes out from the TV stand, it may cause TV set to topple over, fall down, and cause personal injury or damage to the TV.

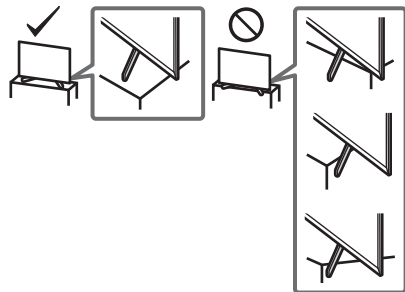

## Transporting

- Before transporting the TV set, disconnect all cables.
- Two or three people are needed to transport a large TV set.
- When transporting the TV set by hand, hold it as shown below.  
Do not put stress on the LCD panel and the frame around the screen.
- When lifting or moving the TV set, hold it firmly from the bottom.

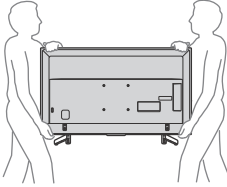

- When transporting the TV set, do not subject it to jolts or excessive vibration.
- When transporting the TV set for repairs or when moving, pack it using the original carton and packing material.

## Topple prevention

(Except models with supplied support belt kit)

KD-55X7002G

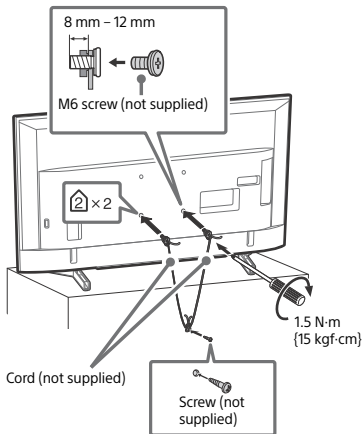

KD-49X7002G / 43X7002G

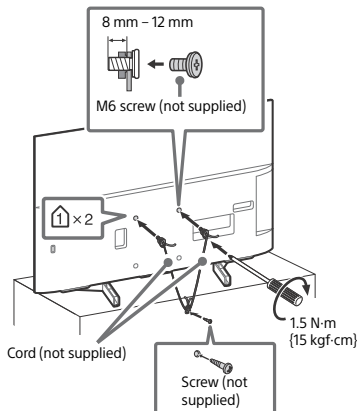

# Parts and Controls

## Controls and Indicators

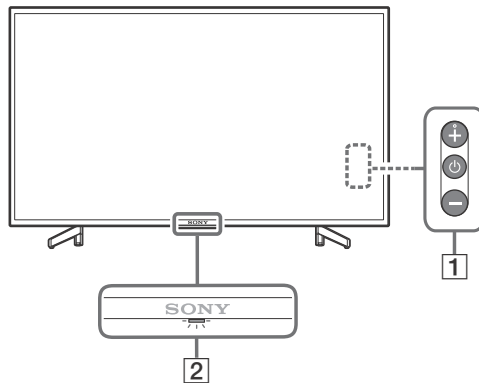



### 1 (Power) /+/-

**When the TV is off,**

Press  to power on.

**When the TV is on,**

Press and hold  to power off.

Press  repeatedly to change the function, then press + or - button to:

- Adjust the volume.
- Select the channel.
- Select the input source of TV.

### Note

- Make sure that the TV is completely turned off before unplugging the AC power cord (mains lead).
- To disconnect the TV from the AC power (mains) completely, pull the plug from the AC power outlet (mains socket).
- Please wait for a while when perform input selection to change to other input.

### 2 Sensors/LED indicator

- Receives signals from the remote control. Do not put anything over the sensor. Doing so may affect its function.
- Lights up in amber when the [Sleep Timer]\* or [On Timer]\* is set, or the TV is in Photo Frame Mode\*.
- Lights up in white when [Power Saving]\* is set to [Picture Off]\*.
- Lights up in white when the TV is turned on.
- Does not light up when the TV is in standby mode.
- Flashes while the remote control is being operated.

\* For more detailed information, press **HOME** on the remote control, then select [Help Guide] under [Settings] menu.

# Using Remote Control

## Remote Control Parts Description

The remote control shape, location, availability and function of remote control buttons may vary depending on your region/country/TV model.

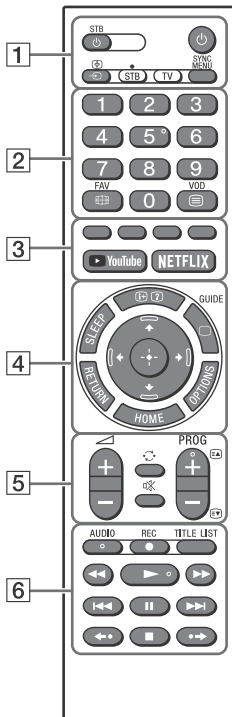

### Note

- The number 5, **▶**, **PROG +** and **AUDIO** buttons have tactile dots. Use the tactile dots as references when operating the TV.
- The buttons with yellow characters printed on it are activated after pressing the STB selector.

For more detailed information on STB related button operation, press **HOME** on the remote control, then select [Help Guide] under [Settings] menu.

### 1 **STB (STB standby) (STB)**

Turn the STB on or switch to standby mode (refer Help Guide).

### **(TV standby) (TV)**

Turn on or turn off the TV (standby mode).

### **(Input select/Text hold) (TV)**

In TV mode: Display and select the input source.

In Text mode: Hold the current page.

### **TV/STB Selector (TV/STB)**

Change Remote to TV/STB Mode (refer Help Guide).

### **SYNC MENU (TV)**

Press to display the BRAVIA Sync Menu and then select connected HDMI equipment from [Device Selection].

The following options can be selected from BRAVIA Sync Menu.

### Device Control:

Use the [Device Control] to operate equipment that is compatible with BRAVIA Sync Control. Select options from [Home (Menu)], [Options], [Content List] and [Power Off] to operate the equipment.

### Speakers:

Select [TV Speakers] or [Audio System] to output the TV's sound from the TV speakers or connected audio equipment.

### TV Control:

Use the [TV Control] menu to operate the TV from the [Home (Menu)] or [Options] menu.

### Return to TV:

Select this option to return to the TV programme.

## 2 Number buttons (TV/STB)

### (Wide Mode) (TV)/FAV (STB)

- Adjust the screen display. Press repeatedly to select the desired wide mode.
- FAV (favourite) for STB (refer Help Guide).

### (Text) (TV)/VOD (STB)

- Display text information.
- VOD (Video on Demand) Access On Demand Service (refer Help Guide).

## 3 Colour buttons (TV/STB)

Execute corresponding function at that time.

### YouTube (Only on limited region/country/TV model) (TV)

Access the "YouTube" online service.

### NETFLIX (Only on limited region/country/TV model) (TV)

Access the "NETFLIX" online service.

## 4 (Info/Text reveal) (TV/STB)

Display information.

### SLEEP (TV)

Press repeatedly until the TV displays the time in minutes ([Off]/[15 min]/[30 min]/[45 min]/[60 min]/[90 min]/[120 min]) that you want the TV to remain on before shutting off. To cancel the sleep timer, press **SLEEP** repeatedly until [Off] appears.

### (TV)/GUIDE (STB)

- Exit Text mode, or switch to a TV display when displaying external input.
- Guide to browse channel (EPG) in STB (refer Help Guide).

### RETURN (TV/STB)

Return to the previous screen.

### OPTIONS (TV)

Display a list that contain shortcuts to some setting menus.

The listed options vary depending on the current input and content.

### HOME (TV/STB)

Display the TV Home Menu.

### (Navigation D-pad) (TV/STB)

On screen menu navigation and selection.

## 5 +/- (Volume) (TV/STB)

Adjust the volume.

### (Jump) (TV/STB)



Return to the previous channel or input viewed more than 15 seconds.

### (Mute) (TV/STB)

Mute the sound. Press again to restore the sound.

### PROG +/-// (TV/STB)

In TV mode: Select the channel.

In Text mode: Select the next () or previous () page.

## 6 AUDIO (TV)

Select the sound of multilingual source or dual sound for the programme currently being viewed (depend on programme source).

### REC (STB)

Record the current programme.

### TITLE LIST (STB)

Display the Title list.

### (TV/STB)

- Operate media contents on the TV and connected BRAVIA Sync-compatible device.
- This key also can be used to operate VOD (Video on Demand) service playback. Availability is depend on VOD service.
-  are not supported for STB.

### (TV)

Replay the scene/briefly fast forwards the scene.

# Connection Diagram

You can connect a wide range of optional equipment to your TV.

**Note**

- Terminals and labels may vary depending on region/country/TV model.

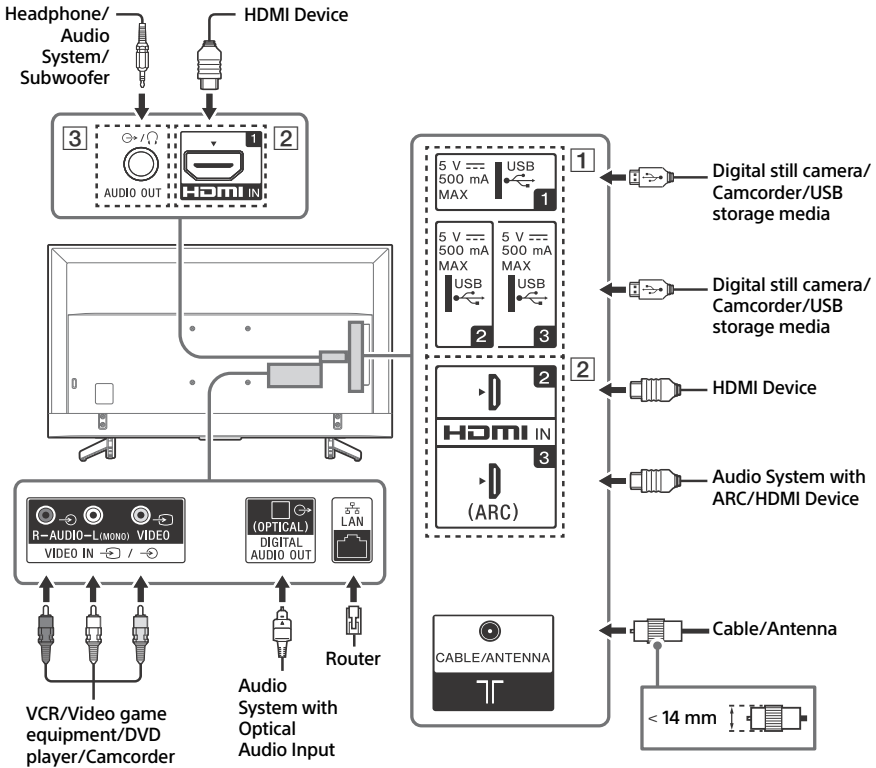

### 1 **USB 1/2/3**

- Connecting a large USB device may interfere with other connected devices beside it.
- When connecting a large USB device, connect to the USB 1 port.

### 2 **HDMI IN 1/2/3**

- HDMI interface can transfer the digital video and audio on a single cable.

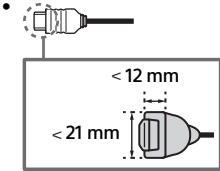

#### • **HDMI IN 2/3**

To enjoy high quality 4K 50p/60p contents, connect a Premium High Speed HDMI cable to the HDMI IN 2/3 and set the [HDMI signal format] to [Enhanced format].

For details of supported formats, refer to the "Specifications" in this manual (page 11-12).

#### • **HDMI IN 3 ARC (Audio Return Channel)**

Connect your audio system to the HDMI IN 3 to route TV audio to your audio system. An audio system that supports HDMI ARC can send video to the TV, and receive audio from the TV via the same HDMI cable. If your audio system does not support HDMI ARC, an additional connection with DIGITAL AUDIO OUT (OPTICAL) is necessary.

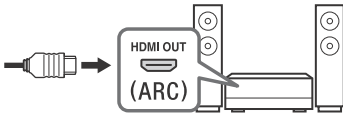

### 3 **AUDIO OUT**

- Supports 3-pole stereo mini jack only.
- To listen to the TV's sound through the connected equipment, press **HOME**, then select [System Settings] → [Setup] → [AV Setup] → [Headphone/Audio Out] and then select the desired item.



## Installing the TV to the Wall

Use the Wall-Mount Bracket (not supplied) to install the TV to the wall.

- Follow the instruction guide provided with the Wall-Mount Bracket for your model. Sufficient expertise is required in installing this TV, especially to determine the strength of the wall for withstanding the TV's weight.
- The length of the screw for Wall-Mount Bracket differs depending on the Wall-Mount Bracket thickness. Please see below illustration.

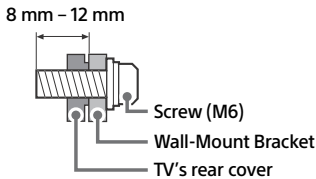

### Note

- Be sure to store the removed screws in a safe place, keeping them away from children.
- If the Table-Top Stand is attached to the TV, detach the Table-Top Stand beforehand. See the Setup Guide and follow in reverse order the steps to detach the Table-Top Stand.
- Place the TV with its screen facing down on a level and stable surface covered with a thick and soft cloth when removing the Table-Top Stand from the TV to prevent damaging the surface of the LCD display. (KD-49/43X7002G only)

### KD-55X7002G

- 1** Attach the Wall-Mount Bracket (not supplied) using the screws (not supplied).

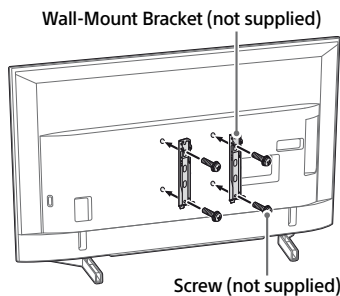

### Note

- If using an electric screwdriver, set the torque at approximately 1.5 N·m (15 kgf·cm).

- 2** To detach the Table-Top Stand from the TV.

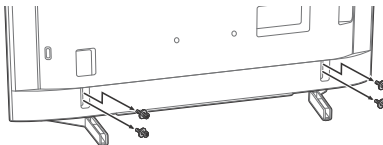

**1** To detach the Table-Top Stand from the TV.

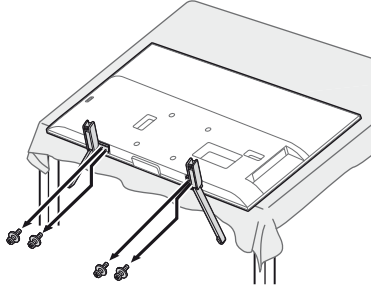

**2** Attach the Wall-Mount Bracket (not supplied) using the screws (not supplied).

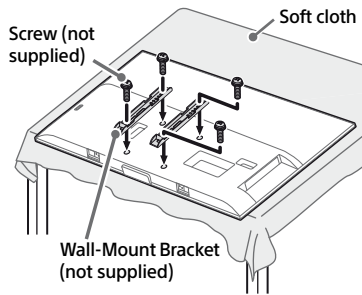

**Note**

- If using an electric screwdriver, set the torque at approximately 1.5 N·m {15 kgf·cm}.

## Troubleshooting

**When the LED indicator is flashing red, count how many times it flashes (interval time is three seconds).**

If the LED indicator flashes red, reset the TV by disconnecting the AC power cord (mains lead) from the TV for two minutes, then turn on the TV.

If the problem persists, contact your dealer or Sony service centre with the number of times the LED indicator flashes red (interval time is three seconds). Press  on the TV to turn it off, disconnect the AC power cord (mains lead), and inform your dealer or Sony service centre.

### Troubles and Solutions

#### No picture (screen is dark) and no sound

- Check the antenna (aerial)/cable connection.
- Connect the TV to the AC power outlet (mains socket), and press  on the TV or the remote control.

#### Picture contours are distorted

- Change the current setting of [Film Mode]\* to other settings.

#### The TV turns off automatically (the TV enters standby mode)

- Check if the [Sleep Timer]\* is activated.
- Check if the [Duration]\* is activated by [On Timer]\* or [Photo Frame Settings]\*.
- Check if the [Idle TV Standby]\* is activated.

#### Some input sources cannot be selected

- Select [Video Labels]\* and select [Always]\* of the input source.

#### Some programmes cannot be tuned

- Check the antenna (aerial)/cable connection.

#### The remote control does not function

- Replace the batteries.

#### The TV surrounds become warm

- When the TV is used for an extended period, the TV surrounds become warm. You may feel hot when touching there by the hand.

\* For more detailed information, press **HOME** on the remote control, then select [Help Guide] under [Settings] menu.

## Specifications

### System

Panel system

LCD (Liquid Crystal Display) Panel, LED Backlight

TV system

Depend on your country/area selection

Analogue: B/G, I, D/K, M

Colour/video system

Analogue: PAL/SECAM/NTSC3.58/NTSC4.43

Channel coverage

Depend on your country/area selection

Analogue: UHF/VHF/Cable

Sound output

10 W + 10 W

Wireless technology

Protocol IEEE 802.11b/g/n

### Input/Output jacks

Antenna (aerial)/cable

75 ohm external terminal for VHF/UHF

  VIDEO IN

 Video input (phono jack)

 AUDIO IN

Audio input (phono jacks)

HDMI IN 1/2/3 (support 4K resolution, HDCP

2.3-compatible)\*<sup>1</sup>

Video:

4096 × 2160p (24, 50, 60 Hz), 3840 × 2160p (24, 25, 30, 50, 60 Hz), 1080p (30, 50, 60 Hz), 1080/24p, 1080i (50, 60 Hz), 720p (30, 50, 60 Hz), 720/24p, 576p, 576i, 480p, 480i

Audio:

Two channel linear PCM: 32/44.1/48 kHz 16/20/24 bits, Dolby Digital, Dolby Digital Plus, DTS

ARC (Audio Return Channel) (HDMI IN 3 only)

Two channel linear PCM: 48 kHz 16 bits, Dolby Digital, Dolby Digital Plus, DTS

 DIGITAL AUDIO OUT (OPTICAL)



Digital optical jack (Two channel linear PCM: 48 kHz 16 bits, Dolby Digital, DTS)

AUDIO OUT   (Stereo mini jack)

Headphone, Audio output, Subwoofer

 1,  2,  3

USB port 1, 2 and 3 support High Speed USB (USB 2.0)

  DC IN 19.5 V (models with supplied AC adapter only)

AC adapter input

## LAN

10BASE-T/100BASE-TX connector (Depending on the operating environment of the network, connection speed may differ. The communication rate and quality are not guaranteed.)

## Others

Operating temperature

0 °C – 40 °C

## Power and others

Power requirements

except models with supplied AC adapter

110 V – 240 V AC, 50/60 Hz

models with supplied AC adapter only

19.5 V DC with AC adapter

Rating: Input 100 V – 240 V AC, 50/60 Hz

Screen size (measured diagonally) (Approx.)

KD-55X7002G: 55 inches / 138.8 cm

KD-49X7002G: 49 inches / 123.2 cm

KD-43X7002G: 43 inches / 108.0 cm

Power consumption

Indicated on the rear of the TV

Standby power consumption\*2\*3

0.5 W

Display resolution

3,840 pixels (horizontal) × 2,160 lines (vertical)

Output Rating

USB 1/2/3

5 V ---, 500 mA MAX

## Dimensions (Approx.) (w × h × d)

with Table-Top Stand

KD-55X7002G: 1,241 × 785 × 336 mm

KD-49X7002G: 1,101 × 704 × 260 mm

KD-43X7002G: 970 × 630 × 260 mm

without Table-Top Stand

KD-55X7002G: 1,241 × 721 × 79 mm

KD-49X7002G: 1,101 × 645 × 57 mm

KD-43X7002G: 970 × 570 × 57 mm

## Mass (Approx.)

with Table-Top Stand

KD-55X7002G: 16.5 kg

KD-49X7002G: 12.5 kg

KD-43X7002G: 10.3 kg

without Table-Top Stand

KD-55X7002G: 15.4 kg

KD-49X7002G: 11.9 kg

KD-43X7002G: 9.7 kg

\*1 HDMI IN 2 and HDMI IN 3 support High-Quality HDMI formats such as 4K 60p/50p 4:2:0 10 bit, 4:4:4, 4:2:2.

\*2 Specified standby power is reached after the TV finishes necessary internal processes.

\*3 Standby power consumption will increase when your TV is connected to the network.

## Note

- Optional accessories availability depends on countries/region/TV model/stock.
- Design and specifications are subject to change without notice.

## Notes on HDR (High Dynamic Range) (Only on limited region/country/TV model)

- Compatible with all HDR PS4 Game titles via HDMI and HDR videos of built-in Netflix and YouTube App only. (See Sony support website for more information).
- HDR image signal specifically means HDR10 Media Profile format (commonly referred to as HDR10).
- Compatibility with all HDR content is not guaranteed.

## Trademark information

- The terms HDMI and HDMI High-Definition Multimedia Interface, and the HDMI Logo are trademarks or registered trademarks of HDMI Licensing Administrator, Inc. in the United States and other countries.
- Manufactured under license from Dolby Laboratories. Dolby, Dolby Audio, and the double-D symbol are trademarks of Dolby Laboratories.
- Vewd® Core. Copyright 1995-2019 Vewd Software AS. All rights reserved.
- Wi-Fi®, Wi-Fi Alliance®, Wi-Fi Direct® and Miracast® are registered trademarks of Wi-Fi Alliance.
- Wi-Fi Protected Setup™ is a trademark of Wi-Fi Alliance.
- The Wi-Fi CERTIFIED™ Logo is a certification mark of Wi-Fi Alliance.
- Netflix is a registered trademark of Netflix, Inc.
- “YouTube” and the “YouTube logo” are registered trademarks of Google LLC.
- “BRAVIA”, BRAVIA and BRAVIA Sync are trademarks or registered marks of Sony Corporation.
- “Blu-ray Disc”, “Blu-ray” and “Blu-ray Disc” logo are trademarks of Blu-ray Disc Association.

- “PlayStation” is a registered trademark and “PS4” is a trademark of Sony Interactive Entertainment Inc.
- For DTS patents, see <http://patents.dts.com>. Manufactured under license from DTS, Inc. DTS, the Symbol, & DTS and the Symbol together are registered trademarks, and DTS Digital Surround is a trademark of DTS, Inc. © DTS, Inc. All Rights Reserved.
- TUXERA is a registered trademark of Tuxera Inc. in the US and other countries.
- All other trademarks are the property of their respective owners.

















Help Guide

[http://rd1.sony.net/help/tv/ginl3/h\\_in/](http://rd1.sony.net/help/tv/ginl3/h_in/)

<http://www.sony.net/>

© 2019 Sony Visual Products Inc.

Printed in India