

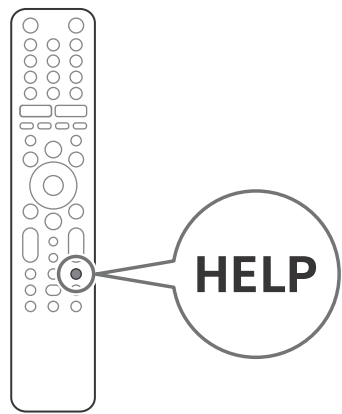

This receiver complies with the minimum requirements as specified in National Telecommunications Commission, Memorandum Circular 02-03-2016, Regarding the Sale and Labeling of ISDB-T Receivers, including Memorandum Circular No. 01-0302017, Amending Certain Provisions of Section 2 of NTC Memorandum Circular No. 02-03-2016 (Sale and Labeling of ISDB-T Receivers).

# Television

## Reference Guide



# BRAVIA

KD-75X9007H / 65X9007H / 55X9007H

## About Manuals

This TV comes with the following manuals. Please retain the manuals for future reference.

<b>Setup Guide</b> • TV installation and setup.	
<b>Reference Guide (this manual) / Safety Documentation</b> • Safety information, remote control, troubleshooting, wall-mount installation, specification, etc.	
<b>Help Guide (On screen Manual)</b> • Settings, Android TV functions, Internet connection, troubleshooting, etc. • To open it, press the <b>HELP</b> button on the remote control and select Help Guide.	 • You can refer to the Help Guide with your smartphone.  <a href="https://rd1.sony.net/help/tv/husltn2/h_usltn/">https://rd1.sony.net/help/tv/husltn2/h_usltn/</a>

**IMPORTANT - Read the End User Software License Agreement before using your Sony product.** Using your product indicates your acceptance of the End User Software License Agreement. The software license agreement between you and Sony is available online at Sony website (<http://www.sony.net/tv-software-licenses/>) or on your product screen. Go to [Settings] → [Device Preferences] → [About] → [Legal information] → [End user license agreement].

- Note**
- Before operating the TV, please read the "Safety Information".
  - Read the supplied safety documentation for additional safety information.
  - Instructions about "Installing the TV to the Wall" are included within this TV's instruction manual.
  - Images and illustrations used in the Setup Guide and this manual are for reference only and may differ from the actual product.

### Location of the identification label

Labels for the TV Model No. and Power Supply rating are located on the rear of the TV.

## Safety Information

### Installation/Set-up

Install and use the TV set in accordance with the instructions below in order to avoid any risk of fire, electric shock or damage and/or injuries.

#### Installation

- The TV set should be installed near an easily accessible AC power outlet (mains socket).
- Place the TV set on a stable, level surface to prevent it from falling over and causing personal injury or property damage.
- Install the TV where it cannot be pulled, pushed, or knocked over.
- Install the TV so that the TV's Table-Top Stand does not protrude out from the TV stand (not supplied). If the Table-Top Stand protrudes out from the TV stand, it may cause TV set to topple over, fall down, and cause personal injury or damage to the TV.

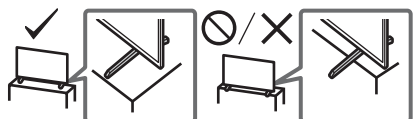

### Transporting

- Before transporting the TV set, disconnect all cables.
- Two or more people are needed to transport a large TV set.
- When transporting the TV set by hand, hold it as shown below. Do not put stress on the LCD panel and the frame around the screen.

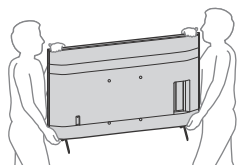

- When transporting the TV set, do not subject it to jolts or excessive vibration.
- When transporting the TV set for repairs or when moving, pack it using the original carton and packing material.

### Topple prevention

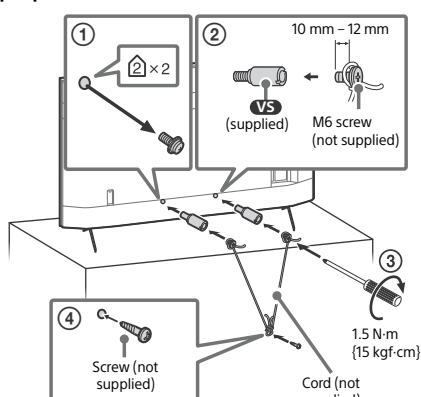

## Remote Control and TV

The remote control shape, location, availability and function of remote control buttons may vary depending on your region/country/TV model.

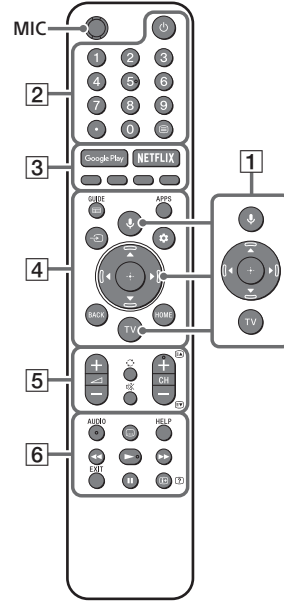

**1** **Microphone:** Use the Google Assistant\*1\*2 or voice search\*2. For hints on how to control your TV press **Microphone** button and speak the phrase "voice hints".\*1

**▲/▼/◀/▶/⊕:** On screen menu navigation and selection.  
**TV:** Display TV channel list or switch to input.

**2** **TV standby**

**Number buttons**

**(dot)**

**(Text):** Display text information.

**3** **Google Play / NETFLIX\*1 / Color buttons**

**4** **GUIDE/☰:** Display the digital program guide.

**APPS:** Display a list of installed apps.

**(Input select):** Display and select the input source, etc.

**(Quick settings):** Display Quick Settings.

**BACK**

**HOME**

**5** **+/- (Volume)**

**(Jump)**

**(Mute)\*3**

**CH +/-/⏪/⏩:** Select the channel, or next (⏩) / previous (⏪) page.

**6** **AUDIO:** Select the sound of multilingual source or dual sound (depend on program source).

**(Subtitle setting)**

**HELP:** Display the Help menu.

**◀◀/▶▶/||**

**EXIT**

**(Info/Text reveal):** Display information.

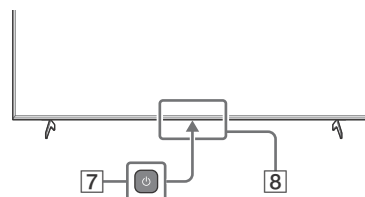

**7** **Power**

**8** **Remote Control sensor / Light sensor / LED**

\*1 Only on limited region/country/TV model/language.

\*2 The Google Assistant or voice search requires an Internet connection.

\*3 Accessibility shortcut is available by pressing and holding **(Mute)**.

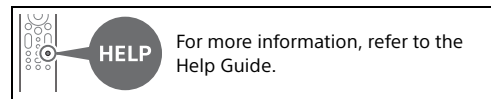

## Wall-Mount Bracket Installation Information

This TV's instruction manual only provides the steps to prepare the TV for Wall-Mount installation before it is installed on the wall. For instructions on Wall-Mount Bracket installation, see the Installation Information (Wall-Mount Bracket) on the product page for your TV model.

<https://www.sony-asia.com/support>

### Preparing for Wall-Mount Installation

Make sure to attach the Table-Top Stand before installing the TV to the wall by referring to the Setup Guide.

- Prepare the TV for the Wall-Mount Bracket before making cable connections.
- Follow the instruction guide provided with the Wall-Mount Bracket for your model. Sufficient expertise is required in installing this TV, especially to determine the strength of the wall for withstanding the TV's weight.
- Be sure to entrust the attachment of this product to the wall to Sony dealers or licensed contractors and pay adequate attention to safety during the installation. Sony is not liable for any damage or injury caused by mishandling or improper installation.
- The screws for Wall-Mount Bracket are not supplied.
- Only qualified service personnel should carry out wall-mount installations.
- For safety reasons, it is strongly recommended that you use Sony accessories, including:  
 –Wall-Mount Bracket SU-WL850  
 –Wall-Mount Bracket SU-WL450
- Be sure to use the screws supplied with the Wall-Mount Bracket when attaching the Wall-Mount Bracket to the TV set. The supplied screws are designed as indicated by illustration when measured from the attaching surface of the Wall-Mount Bracket.

The diameter and length of the screws differ depending on the Wall-Mount Bracket model. Use of screws other than those supplied may result in internal damage to the TV set or cause it to fall, etc.

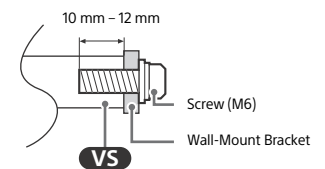

- Be sure to store the unused screws and Table-Top Stand in a safe place until you are ready to attach the Table-Top Stand. Keep the screws away from small children.

\* Only on limited region/country/TV model.

### 1 Remove the screws from the rear of the TV.

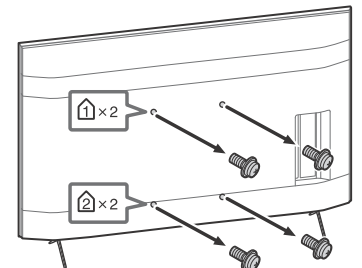

### 2 Attach the Wall-Mount Attachment (supplied with the TV) to the rear of the TV (to make it parallel with the wall).

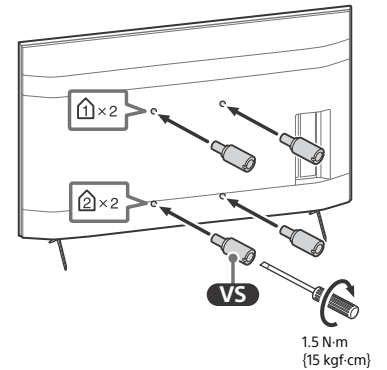

### Note

- If using an electric screwdriver, set the torque at approximately 1.5 N·m (15 kgf·cm).
- Be sure to fasten the Wall-Mount Attachment when attaching them to the TV.

Use only a flat head screwdriver to install the Wall-Mount Attachment. Use of another tool might result in over torquing the Wall-Mount Attachment and damaging the TV.

## Installing the TV to the Wall

### Using the optional Wall-Mount Bracket (SU-WL850 or SU-WL450)\* (not supplied)

#### To Customers:

For product protection and safety reasons, Sony strongly recommends that installation of your TV be performed by Sony dealers or licensed contractors. Do not attempt to install it yourself.

#### To Sony Dealers and Contractors:

Provide full attention to safety during the installation, periodic maintenance and examination of this product.

## Detaching the Table-Top Stand from the TV

- 1 Remove one side of the Table-Top Stand at a time. Firmly hold the Table-Top Stand securely with both hands while the other people lift up the TV.

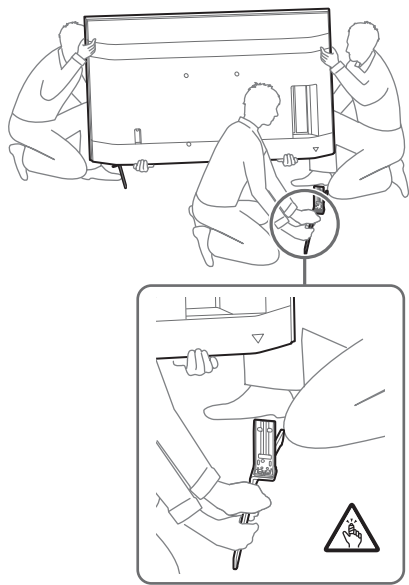

- 2 Repeat the previous step and remove the other side of the Table-Top Stand.

### Note

- Three or more people are required to detach the Table-Top Stand.
- Be careful not to use excessive force while detaching the Table-Top Stand from the TV as it may cause the TV set to fall resulting in personal injury or physical damage to the TV.
- Take care when handling the Table-Top Stand to prevent damage to the TV.
- Be careful when lifting the TV as the Table-Top Stand is detached, the Table-Top Stand may topple over and cause personal injury.
- Take care when removing the Table-Top Stand from the TV to prevent it from falling over and damaging the surface that the TV is sitting on.

## Troubleshooting

General troubleshooting for issues like: black screen, no sound, frozen picture, TV does not respond, or network is lost, do the following steps.

- 1 Restart your TV by pressing the power button on the remote control for about five seconds. The TV will restart. If the TV does not recover, try unplugging the AC power cord (mains lead). Then press the power button on the TV, and release it. Wait for two minutes, and plug in the AC power cord (mains lead).
- 2 Refer to the Help menu by pressing **HELP** on the remote control.
- 3 Connect your TV to the Internet and perform a software update. Sony recommends you to keep your TV software updated. Software updates provide new features and performance improvements.
- 4 Visit Sony support website (information provided at the end of this manual).

**When you plug in the TV, the TV may not be able to turn on for a while even if you press the power button on the remote control or the TV.**

It takes time to initialize the system. Wait for about one minute, then operate it again.

**The remote control does not function.**

- Replace the batteries.

**The parental lock password has been forgotten.**

- Enter 4357 for the PIN and enter the new PIN.

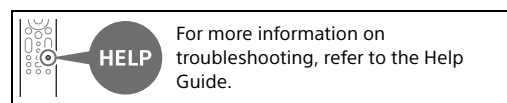

## Specifications

### System

Panel system: LCD (Liquid Crystal Display) Panel, LED Backlight

TV system

Analog: M

Digital: ISDB-T

Color system: NTSC/PAL N(Video Only)/PAL M(Video Only)

Channel coverage

Analog: UHF/VHF/Cable

Digital: UHF/VHF

Sound output: 10 W + 10 W

Wireless technology

Protocol IEEE 802.11a/b/g/n/ac

Bluetooth® Version 4.2

### Input/Output jacks

Antenna (aerial)/cable

75 ohm external terminal for VHF/UHF

VIDEO IN

Video/Audio input (mini jack)

HDMI IN 1/2/3/4 (support 4K resolution, HDCP

2.3-compatible)

Video:

4096 × 2160p (50, 60 Hz)\*1\*2, 4096 × 2160p (24 Hz)\*1, 3840 × 2160p (50, 60 Hz)\*2, 3840 × 2160p (24, 25, 30 Hz), 1080p (30, 50, 60, 100, 120 Hz), 1080/24p, 1080i (50, 60 Hz), 720p (30, 50, 60 Hz), 720/24p, 576p, 480p, PC Formats\*3

Audio:

5.1 channel linear PCM: 32/44.1/48/88.2/96/176.4/192 kHz 16/20/24 bits, Dolby Audio, Dolby Atmos, DTS

ARC (Audio Return Channel) (HDMI IN 3 only)\*4

Two channel linear PCM: 48 kHz 16 bits, Dolby Audio, Dolby Atmos, DTS

DIGITAL AUDIO OUT (OPTICAL)

Digital optical jack (Two channel linear PCM: 48 kHz 16 bits, Dolby Audio, DTS)

(Stereo mini jack)

Headphone

1, 2

USB port 1 supports High Speed USB (USB 2.0)

USB port 2 supports Super Speed USB (USB 3.1 Gen 1)

LAN

10BASE-T/100BASE-TX connector (Depending on the operating environment of the network, connection speed may differ. The communication rate and quality are not guaranteed.)

### Power and others

Power requirements

220 V – 240 V AC, 50/60 Hz

Screen size (measured diagonally) (Approx.)

KD-75X9007H: 75 inches / 189.3 cm

KD-65X9007H: 65 inches / 163.9 cm

KD-55X9007H: 55 inches / 138.8 cm

Power consumption

KD-75X9007H: 277 W

KD-65X9007H: 214W

KD-55X9007H: 173 W

Standby power consumption\*5\*6

0.5 W

Display resolution

3,840 pixels (horizontal) × 2,160 lines (vertical)

Output Rating

USB 1

5 V ---, 500 mA MAX

USB 2

5 V ---, 900 mA MAX

### Dimensions (Approx.) (w × h × d) (mm)

with Table-Top Stand (without Table-Top Stand)

KD-75X9007H: 1,674 × 1,034 × 410 (1,674 × 961 × 71)

KD-65X9007H: 1,450 × 903 × 338 (1,450 × 833 × 70)

KD-55X9007H: 1,231 × 780 × 338 (1,231 × 710 × 70)

### Mass (Approx.) (kg)

with Table-Top Stand (without Table-Top Stand)

KD-75X9007H: 34.4 (32.9)

KD-65X9007H: 23.2 (22.2)

KD-55X9007H: 17.5 (16.5)

### Others

Optional accessories

Wall-Mount Bracket: SU-WL850 / SU-WL450

Operating temperature: 0 °C – 40 °C

\*1 When 4096 × 2160p is input and [Wide mode] is set to [Normal], the resolution is displayed as 3840 × 2160p. To display 4096 × 2160p, set [Wide mode] setting to [Full 1] or [Full 2].

\*2 To support 18 Gbps, set [HDMI signal format] to [Enhanced format].

\*3 Refer to the online Help Guide for details.

\*4 Connect your audio system to the HDMI IN 3 to route TV audio to your audio system.

\*5 Specified standby power is reached after the TV finishes necessary internal processes.

\*6 Standby power consumption will increase when your TV is connected to the network.

### Note

- Optional accessories availability depends on countries/region/TV model/stock.
- Design and specifications are subject to change without notice.
- Subscriptions for services and applications may be required and additional terms, conditions and/or charges may apply when using the Google Assistant.

### Trademark Information

- The terms HDMI, HDMI High-Definition Multimedia Interface, and the HDMI Logo are trademarks or registered trademarks of HDMI Licensing Administrator, Inc.
- Dolby, Dolby Vision, Dolby Atmos, Dolby Audio, and the double-D symbol are trademarks of Dolby Laboratories. Manufactured under license from Dolby Laboratories. Confidential unpublished works. Copyright © 2012-2018 Dolby Laboratories. All rights reserved.
- Gracenote, the Gracenote logo and logotype, "Powered by Gracenote" logo are either registered trademarks or trademarks of Gracenote, Inc. in the United States and/or other countries.
- Google, Google Play, Chromecast, YouTube, Android TV and other related marks and logos are trademarks of Google LLC.
- For DTS patents, see <http://patents.dts.com>. Manufactured under license from DTS, Inc. DTS, the Symbol, DTS and the Symbol together, and Digital Surround are registered trademarks or trademarks of DTS, Inc. in the United States and/or other countries. © DTS, Inc. All Rights Reserved.
- Netflix is a registered trademark of Netflix, Inc.
- TUXERA is a registered trademark of Tuxera Inc. in the US and other countries.
- All other trademarks are the property of their respective owners.

**HDMI**  
HIGH-DEFINITION MULTIMEDIA INTERFACE



**TUXERA**

