

SONY®

5-014-738-11(1)



Television

Reference Guide

GB

參考指南

CT

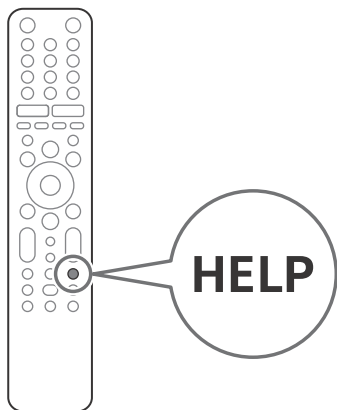

BRAVIA

KD-49X9500H

About Manuals

This TV comes with the following manuals. Please retain the manuals for future reference.

Setup Guide

- TV installation and setup.

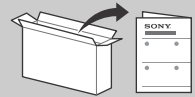

Reference Guide (this manual) / Safety Documentation

- Safety information, remote control, troubleshooting, wall-mount installation, specification, etc.



Help Guide (On screen Manual)

- Settings, Android TV functions, Internet connection, troubleshooting, etc.
- To open it, press the **HELP** button on the remote control and select Help Guide.



- You can refer to the Help Guide with your smartphone.



https://rd1.sony.net/help/tv/hga1/h_ga/

IMPORTANT - Read the End User Software Licence Agreement before using your Sony product. Using your product indicates your acceptance of the End User Software Licence Agreement. The software licence agreement between you and Sony is available online at Sony website (<http://www.sony.net/tv-software-licenses/>) or on your product screen. Go to [Settings] → [Device Preferences] → [About] → [Legal information] → [Notices and licences].

Note

- Before operating the TV, please read the "Safety Information".
- Read the supplied safety documentation for additional safety information.
- Instructions about "Installing the TV to the Wall" are included within this TV's instruction manual.
- Images and illustrations used in the Setup Guide and this manual are for reference only and may differ from the actual product.

Location of the identification label

Labels for the TV Model No. and Power Supply rating are located on the rear of the TV.

This television is designed for use in Hong Kong and ensured the usage in Hong Kong only.

Safety Information

Installation/Set-up

Install and use the TV set in accordance with the instructions below in order to avoid any risk of fire, electric shock or damage and/or injuries.

Installation

- The TV set should be installed near an easily accessible AC power outlet (mains socket).
- Place the TV set on a stable, level surface to prevent it from falling over and causing personal injury or property damage.
- Install the TV where it cannot be pulled, pushed, or knocked over.

- Install the TV so that the TV's Table-Top Stand does not protrude out from the TV stand (not supplied). If the Table-Top Stand protrudes out from the TV stand, it may cause TV set to topple over, fall down, and cause personal injury or damage to the TV.

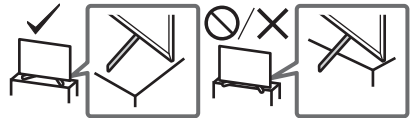

Transporting

- Before transporting the TV set, disconnect all cables.
- Two or more people are needed to transport a large TV set.
- When transporting the TV set by hand, hold it as shown below. Do not put stress on the LCD panel and the frame around the screen.

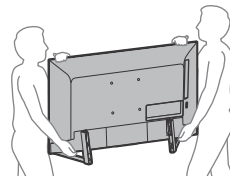

- When transporting the TV set, do not subject it to jolts or excessive vibration.
- When transporting the TV set for repairs or when moving, pack it using the original carton and packing material.

Topple prevention

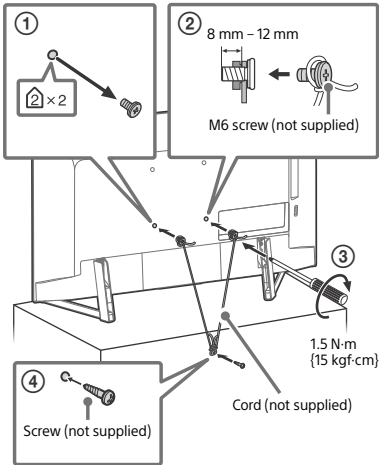

Remote Control and TV

The remote control shape, location, availability and function of remote control buttons may vary depending on your region/country/TV model.

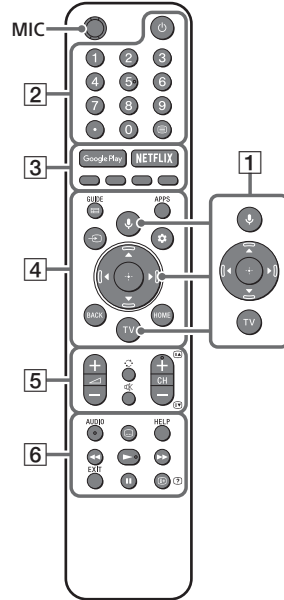

GB





- ① **🎤 (Microphone):** Use voice search*¹.
▲/▼/◀/▶/⊕: On screen menu navigation and selection.
TV: Display TV channel list or switch to input.
- ② **🔌 (TV standby)**
Number buttons
● (dot)
☰ (Text): Display text information.
- ③ **Google Play / NETFLIX*² / Colour buttons**
- ④ **GUIDE/☰:** Display the digital programme guide.
APPS: Display a list of installed apps.
→ (Input select): Display and select the input source, etc.
⚙️ (Quick settings): Display Quick Settings.
BACK

HOME

5 +/- (Volume)

 (Jump)

 (Mute)*3

CH +/-/: Select the channel, or next () / previous () page.

6 **AUDIO:** Select the sound of multilingual source or dual sound (depend on programme source).

 (Subtitle setting)

HELP: Display the Help menu.



EXIT

/? (Info/Text reveal): Display information.

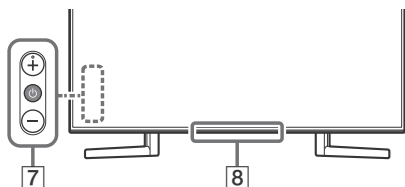

7 (Power)/+/-

8 **Remote Control sensor / Light sensor / Illumination LED**

*1 The voice search requires an Internet connection.

*2 Only on limited region/country/TV model/language.

*3 Accessibility shortcut is available by pressing and holding  (Mute).

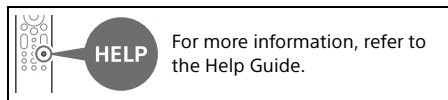

Installing the TV to the Wall

Using the optional Wall-Mount Bracket (SU-WL450)* (not supplied)

To Customers:

For product protection and safety reasons, Sony strongly recommends that installation of your TV be performed by Sony dealers or licensed contractors. Do not attempt to install it yourself.

To Sony Dealers and Contractors:

Provide full attention to safety during the installation, periodic maintenance and examination of this product.

Wall-Mount Bracket Installation Information

This TV's instruction manual only provides the steps to prepare the TV for Wall-Mount installation before it is installed on the wall. For instructions on Wall-Mount Bracket installation, see the Installation Information (Wall-Mount Bracket) on the product page for your TV model. <https://www.sony-asia.com/support>

Preparing for Wall-Mount Installation

Make sure to attach the Table-Top Stand before installing the TV to the wall by referring to the Setup Guide.

- Prepare the TV for the Wall-Mount Bracket before making cable connections.
- Follow the instruction guide provided with the Wall-Mount Bracket for your model. Sufficient expertise is required in installing this TV, especially to determine the strength of the wall for withstanding the TV's weight.
- Be sure to entrust the attachment of this product to the wall to Sony dealers or licensed contractors and pay adequate attention to safety during the installation. Sony is not liable for any damage or injury caused by mishandling or improper installation.
- The screws for Wall-Mount Bracket are not supplied.
- Only qualified service personnel should carry out wall-mount installations.
- For safety reasons, it is strongly recommended that you use Sony accessories, including:
 - Wall-Mount Bracket SU-WL450

- Be sure to use the screws supplied with the Wall-Mount Bracket when attaching the Wall-Mount Bracket to the TV set. The supplied screws are designed as indicated by illustration when measured from the attaching surface of the Wall-Mount Bracket. The diameter and length of the screws differ depending on the Wall-Mount Bracket model. Use of screws other than those supplied may result in internal damage to the TV set or cause it to fall, etc.

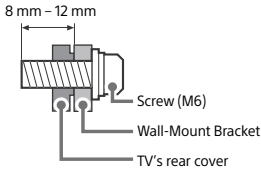

- Be sure to store the unused screws and Table-Top Stand in a safe place until you are ready to attach the Table-Top Stand. Keep the screws away from small children.
- * Only on limited region/country/TV model.

Remove the screws from the rear of the TV.

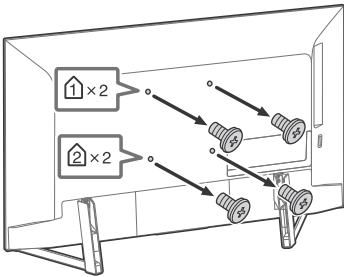

Troubleshooting

General troubleshooting for issues like: black screen, no sound, frozen picture, TV does not respond, or network is lost, do the following steps.

- 1 Restart your TV by pressing the power button on the remote control for about five seconds. The TV will restart. If the TV does not recover, try unplugging the AC power cord (mains lead). Then press the power button on the TV, and release it. Wait for two minutes, and plug in the AC power cord (mains lead).
- 2 Refer to the Help menu by pressing **HELP** on the remote control.
- 3 Connect your TV to the Internet and perform a software update. Sony recommends you to keep your TV software updated. Software updates provide new features and performance improvements.
- 4 Visit Sony support website (information provided at the end of this manual).

When you plug in the TV, the TV may not be able to turn on for a while even if you press the power button on the remote control or the TV.

It takes time to initialize the system. Wait for about one minute, then operate it again.

The remote control does not function.

- Replace the batteries.

The parental lock password has been forgotten.

- Enter 9999 for the PIN and enter the new PIN.



For more information on troubleshooting, refer to the Help Guide.

Specifications

System

Panel system: LCD (Liquid Crystal Display) Panel,
LED Backlight

TV system:

Analogue: I, D/K, B/G, M

Digital: DTMB

Colour system: PAL/SECAM/NTSC3.58/
NTSC4.43

Channel coverage:

Analogue: UHF/VHF/Cable

Digital: UHF

Sound output: 10 W + 10 W

Wireless technology

Protocol IEEE 802.11a/b/g/n/ac

Bluetooth® Version 4.2

Input/Output jacks

Antenna (aerial)/cable

75 ohm external terminal for VHF/UHF

VIDEO IN

Video/Audio input (mini jack)

HDMI IN 1/2/3/4 (support 4K resolution, HDCP
2.3-compatible)

Video:

4096 × 2160p (50, 60 Hz)^{*1*2}, 4096 × 2160p
(24 Hz)^{*1}, 3840 × 2160p (50, 60 Hz)^{*2}, 3840 ×
2160p (24, 25, 30 Hz), 1080p (30, 50, 60, 100,
120 Hz), 1080/24p, 1080i (50, 60 Hz), 720p
(30, 50, 60 Hz), 720/24p, 576p, 480p, PC
Formats^{*3}

Audio:

In eARC (Enhanced Audio Return Channel)
mode

Refer to the Help Guide for details.

Except eARC mode

5.1 channel linear PCM: 32/44.1/48/88.2/
96/176.4/192 kHz 16/20/24 bits, Dolby
Audio, Dolby Atmos, DTS

eARC/ARC (Enhanced Audio Return Channel/
Audio Return Channel) (HDMI IN 3 only)^{*4}

In eARC mode

Refer to the Help Guide for details.

In ARC mode

Two channel linear PCM: 48 kHz 16 bits,
Dolby Audio, Dolby Atmos, DTS

DIGITAL AUDIO OUT (OPTICAL)

Digital optical jack (Two channel linear PCM:
48 kHz 16 bits, Dolby Audio, DTS)

(Stereo mini jack)

Headphone

USB 1, 2, 3

USB port 1 and 2 support High Speed USB

(USB 2.0)

USB port 3 supports Super Speed USB (USB 3.1
Gen 1)

LAN

10BASE-T/100BASE-TX connector (Depending
on the operating environment of the network,
connection speed may differ. The
communication rate and quality are not
guaranteed.)

Power and others

Power requirements

220 V – 240 V AC, 50 Hz

Screen size (measured diagonally) (Approx.)

49 inches / 123.2 cm

Power consumption

Indicated on the rear of the TV

Standby power consumption^{*5*6}
0.5 W

Display resolution

3,840 pixels (horizontal) × 2,160 lines (vertical)

Output Rating

USB 1/2

5 V ---, 500 mA MAX

USB 3

5 V ---, 900 mA MAX

Dimensions (Approx.) (w × h × d) (mm)

with Table-Top Stand (without Table-Top Stand)

1,093 × 699 × 261 (1,093 × 629 × 69)

Mass (Approx.) (kg)

with Table-Top Stand (without Table-Top Stand)

14.4 (13.3)

Others

Optional accessories

Wall-Mount Bracket: SU-WL450

Operating temperature: 0 °C – 40 °C

Operating humidity: 10 % – 80 % RH
(non-condensing)

^{*1} When 4096 × 2160p is input and [Wide mode] is set
to [Normal], the resolution is displayed as 3840 ×
2160p. To display 4096 × 2160p, set [Wide mode]
setting to [Full 1] or [Full 2].

^{*2} To support 18 Gbps, set [HDMI signal format] to
[Enhanced format].

^{*3} Refer to the online Help Guide for details.

^{*4} Connect your audio system to the HDMI IN 3 to route
TV audio to your audio system.

^{*5} Specified standby power is reached after the TV
finishes necessary internal processes.

^{*6} Standby power consumption will increase when
your TV is connected to the network.

Note

- Optional accessories availability depends on countries/region/TV model/stock.
- Design and specifications are subject to change without notice.

Trademark Information

- The terms HDMI, HDMI High-Definition Multimedia Interface, and the HDMI Logo are trademarks or registered trademarks of HDMI Licensing Administrator, Inc.
- Dolby, Dolby Vision, Dolby Atmos, Dolby Audio, and the double-D symbol are trademarks of Dolby Laboratories. Manufactured under license from Dolby Laboratories. Confidential unpublished works. Copyright © 2012-2018 Dolby Laboratories. All rights reserved.
- Gracenote, the Gracenote logo and logotype, "Powered by Gracenote" logo are either registered trademarks or trademarks of Gracenote, Inc. in the United States and/or other countries.
- Google, Google Play, Chromecast, YouTube, Android TV and other related marks and logos are trademarks of Google LLC.
- For DTS patents, see <http://patents.dts.com>. Manufactured under license from DTS, Inc. DTS, the Symbol, DTS and the Symbol together, and Digital Surround are registered trademarks or trademarks of DTS, Inc. in the United States and/or other countries. © DTS, Inc. All Rights Reserved.
- Netflix is a registered trademark of Netflix, Inc.
- © 2019 RealNetworks, Inc. All rights reserved. Patents issued. RealMedia, RealNetworks, and their logos are trademarks or registered trademarks of RealNetworks, Inc.
- TUXERA is a registered trademark of Tuxera Inc. in the US and other countries.
- All other trademarks are the property of their respective owners.

關於說明書

本電視機附帶以下說明書。請保管好這些說明書，以供日後參考。

安裝指南

- 電視機安裝和設定。



參考指南（本說明書）/ 安全檔案

- 安全資訊、遙控器、故障排除、壁掛式安裝、規格等。



說明指南（電子說明書）

- 設定、Android TV 功能、網際網路連線、故障排除等。
- 想要打開說明指南，請按遙控器上的 HELP 按鈕，選擇說明指南。



- 您可以使用您的智能手機來查閱說明指南。



https://rd1.sony.net/help/tv/hga1/h_ga/

重要 - 在使用 Sony 產品之前，請先閱讀終端使用者軟體授權合約。 若使用您的產品，則表示您接受終端使用者軟體授權合約。您與 Sony 之間的軟體授權合約可在 Sony 網站 (<http://www.sony.net/tv-software-licenses/>) 上線上獲取，也可在您產品的螢幕上獲取。進入 [設定] → [裝置偏好設定] → [關於] → [法律資訊] → [注意事項和授權]。

註

- 使用電視機之前，請詳讀“安全資訊”。
- 有關其他安全資訊，請閱讀隨附的安全檔案。
- 有關“將電視機安裝在牆上”的指示已包含在這台電視機的使用說明書。
- 安裝指南和本說明書中使用的影像和插圖僅作參考並可能與實際產品不同。

識別標籤的位置

電視機型號和電源等級的標籤位於電視機背面。

本電視設計在香港使用，只保證能在香港使用。

安全資訊

安裝 / 設定

為了避免火災、觸電或損壞及 / 或受傷等危險，請遵照下列指示來安裝和使用電視機。

安裝

- 應將電視機安裝在易於插拔的 AC 電源插座附近。
- 將電視機放在一個穩定的平面，以防止墜落和引起個人傷害或財產損壞。
- 應將電視機安裝在不容易被拉、推或碰倒之處。
- 安裝電視機，使電視機的桌面底座不會從電視機櫃（非附帶）凸出。如果桌面底座從電視機櫃凸出，可能導致電視機翻倒、掉落及人身傷害或對電視機造成損壞。

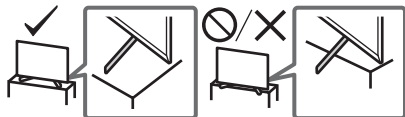

搬動

- 搬動電視機之前，請斷開所有纜線的連接。
- 兩個或更多的人都需要運輸的大電視機。
- 用手搬動電視機時，請如下圖所示抓握。請勿對液晶面板以及螢幕周圍的框邊施加壓力。

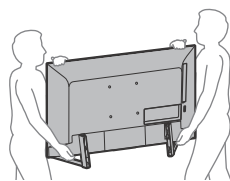

- 搬動電視機時，請勿使其受到搖晃或過度震動。
- 搬動電視機以進行維修或移動時，請使用原有的紙箱和包裝材料進行包裝。

防止傾倒

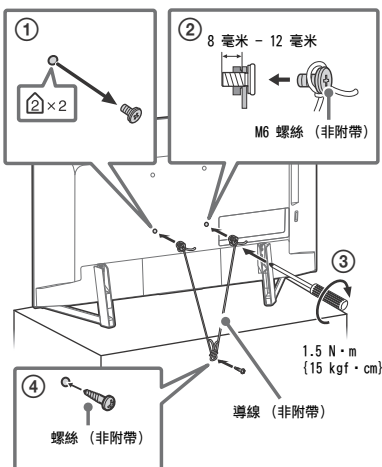

遙控器和電視機

遙控器外形、按鈕的位置、可用性與功能視您的國家 / 區域 / 電視機型號而可能略有不同。

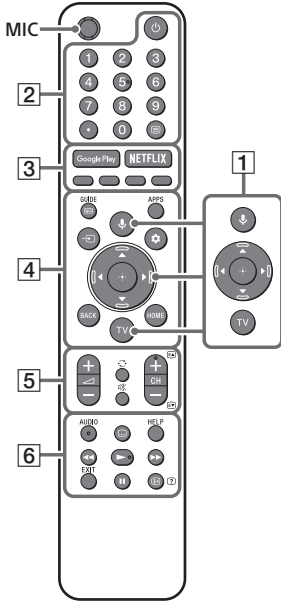

- 1 (麥克風)：使用語音搜尋 *1。
▲/▼/◀/▶/⊕：在螢幕選單導航和選擇上。
TV：顯示電視機頻道清單或切換為輸入。
- 2 (電視待機)
數字按鈕
 (點)
 (文字)：顯示文字資訊。
- 3 Google Play / NETFLIX*2 / 顏色按鈕
- 4 (GUIDE) / ：顯示數位節目指南。
APPS：顯示已安裝應用程式的清單。
→ (輸入選擇)：顯示並選擇輸入來源等。
⚙ (快速設定)：顯示快速設定。
BACK
HOME

- 5 +/- (音量)
 (跳轉)
 (靜音) *3
CH +/- / / ：選擇頻道，或下一頁 () / 上一頁 ()。

- 6 **AUDIO**：選擇多語言源的聲音或雙聲道 (視乎節目源而定)。
 (字幕設定)
HELP：顯示說明選單。
◀◀/▶▶/▶▶/||
EXIT
 / (顯現資訊 / 文字)：顯示資訊。

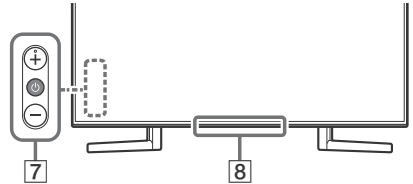

- 7 (電源) +/-
- 8 遙控器感應器 / 光感應器 / 照明 LED

*1 語音搜尋需要網際網路連線。
*2 僅限限制的區域 / 國家 / 電視機型號 / 語言。
*3 按住 (靜音) 可使用輔助使用快捷鍵。

HELP 有關更多资讯，請參閱說明指南。

CT

將電視機安裝在牆上

使用選購的壁掛式支架 (SU-WL450)* (非附帶)

致客戶：

出於產品保護及安全原因，Sony 強烈建議由 Sony 經銷商或授權的承包商安裝電視機。請勿嘗試自行安裝電視機。

致 Sony 經銷商和承包商：

安裝、定期維護及檢查本產品時，請充分注意安全。

壁掛式支架安裝資訊

本電視機使用說明書僅提供將電視機安裝到牆上前準備電視機進行壁掛式安裝的步驟。有關壁掛式支架安裝的說明，請參閱您的電視機型號的產品頁上的安裝訊息（壁掛式支架）。

<https://www.sony-asia.com/support>

準備壁掛式安裝

請參閱《安裝指南》，確保先連接桌面底座，然後將電視機安裝到牆上。

- 讓電視機準備用於壁掛式支架，然後連接纜線。
- 請遵循適合您的型號的壁掛式支架隨附的使用說明手冊。安裝本電視機須具備充足的專業知識，確定牆壁是否能夠承受電視重量時尤為如此。
- 務必委託 Sony 經銷商或授權的承包商將本產品安裝至牆壁上，並在安裝期間充分注意安全。對於因錯誤操作或安裝不當引致的任何損害，Sony 概不負責。
- 未附帶壁掛式支架的螺釘。
- 僅可由合格的維修人員執行掛壁安裝。
- 為了安全起見，強烈建議您使用 Sony 配件，包括：
 - 壁掛式支架 SU-WL450
- 將掛鉤（底座）/ 壁掛式支架安裝於電視機上時，務必要使用隨附於壁掛式支架的螺絲。隨附螺絲如插圖所示設計從掛鉤（底座）/ 壁掛式支架安裝表面量起。螺絲的直徑和長度會因為壁掛式支架的型號而有所不同。使用隨附螺絲以外的螺絲可能會造成電視機內部損壞或者掉落等等。

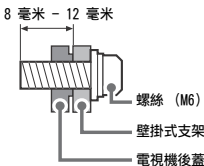

- 務必將未使用的螺絲及桌面底座存放於安全位置，直到您已準備好連接桌面底座。請將螺絲存放在兒童接觸不到的位置。

* 僅限限制的區域 / 國家 / 電視機型號。

從電視機背面卸下螺絲。

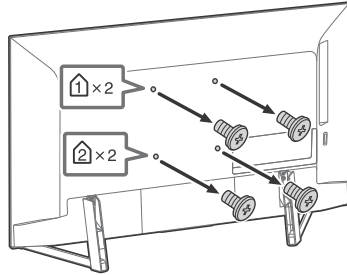

故障排除

以下問題的一般故障排除：黑螢幕、沒有聲音、凍結畫面、電視機沒有反應或網絡丟失，請依照以下步驟操作。

- 按遙控器上的電源按鈕大約五秒重新啟動電視機。電視機將重新啟動。如果電視機未恢復正常，請嘗試拔下 AC 電源線。然後按電視機上的電源按鈕，再鬆開此按鈕。等候兩分鐘，隨後插入 AC 電源線。
- 請按遙控器上的 **HELP** 以參閱說明選單。
- 將電視機連接至網路，然後執行軟件更新。Sony 建議您不斷更新您的電視機軟件。軟件更新將提供新功能和效能改善。
- 造訪 Sony 支持網站（本說明書末尾提供的資訊）。

在插入電視機時，即使按遙控器或電視機上的電源按鈕，電視機也可能在一定時間不能開啟。系統初始化需要一定時間。等待大約一分鐘，然後再次操作。

遙控器無效。

- 更換電池。

忘記家長鎖定的密碼。

- PIN 碼輸入 9999，然後輸入新的 PIN 碼。

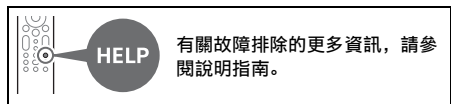

規格

系統

面板系統：LCD（液晶顯示）面板，LED 背光源

電視系統：

模擬：I, D/K, B/G, M

數位：DTMB

彩色系統：PAL/SECAM/NTSC3.58/NTSC4.43

頻道涵蓋範圍：

模擬：UHF/VHF/纜線

數位：UHF

聲音輸出：10 瓦 + 10 瓦

無線技術

IEEE 802.11a/b/g/n/ac 協議

藍牙® 版本 4.2

輸入 / 輸出插孔

天線 / 纜線

VHF/UHF 的 75 歐姆外接端子

VIDEO IN

視訊 / 音訊輸入（迷你插孔）

HDMI IN 1/2/3/4（支援 4K 解析度、HDCP 2.3 相容）

視訊：

4096 × 2160p (50, 60 Hz)*1*2, 4096 × 2160p (24 Hz)*1, 3840 × 2160p (50, 60 Hz)*2, 3840 × 2160p (24, 25, 30 Hz), 1080p (30, 50, 60, 100, 120 Hz), 1080/24p, 1080i (50, 60 Hz), 720p (30, 50, 60 Hz), 720/24p, 576p, 480p, PC 格式*3

音訊：

在 eARC (Enhanced Audio Return Channel) 模式下

有關詳情，請參閱說明指南。

eARC 模式除外

5.1 聲道線性 PCM: 32/44.1/48/88.2/96/176.4/192 kHz 16/20/24 位元, Dolby Audio, Dolby Atmos, DTS

eARC/ARC (Enhanced Audio Return Channel/ Audio Return Channel) (僅限 HDMI IN 3) *4

在 eARC 模式下

有關詳情，請參閱說明指南。

在 ARC 模式下

兩聲道線性 PCM: 48 kHz 16 位元, Dolby Audio, Dolby Atmos, DTS

DIGITAL AUDIO OUT (OPTICAL)

數位光纖插孔（兩聲道線性 PCM: 48 kHz 16 位元, Dolby Audio, DTS）

（立體聲迷你插孔）

耳機

1、2、3

USB 連接埠 1 和 2 支援高速 USB (USB 2.0)

USB 連接埠 3 支援超快速 USB (USB 3.1 Gen 1)

LAN

10BASE-T/100BASE-TX 接頭（視網絡的作業環境而定，連線速度可能不同。不保證通訊率和通訊品質。）

電源和其他規格

電源需求

220 V - 240 V AC, 50 Hz

螢幕尺寸（對角測量）（大約）

49 英寸 / 123.2 厘米

耗電量

見電視機背面

待機耗電量 *5*6

0.5 瓦

顯示解析度

3840 畫素（水平）× 2160 條線（垂直）

輸出率

USB 1/2

5 V ---, 500 mA 最大值

USB 3

5 V ---, 900 mA 最大值

尺寸（大約）（寬 × 高 × 深）（毫米）

包含桌面底座（不含桌面底座）

1093 × 699 × 261 (1093 × 629 × 69)

重量（大約）（千克）

包含桌面底座（不含桌面底座）

14.4 (13.3)

其他

選用的配件

壁掛式支架：SU-WL450

作業溫度：0 °C - 40 °C

操作濕度：10 % - 80 % 相對濕度（非凝）

*1 當輸入 4096 × 2160p 且 [寬螢幕模式] 設為 [正常模式] 時，解析度將顯示為 3840 × 2160p。要顯示 4096 × 2160p，請將 [寬螢幕模式] 設定設為 [全螢幕模式 1] 或 [全螢幕模式 2]。

*2 若要支援 18 Gbps，將 [HDMI 訊號格式] 設定為 [增強格式]。

*3 有關詳情，請參閱線上說明指南。

*4 將音訊系統連接至 HDMI IN 3 以傳送電視機音訊至音訊系統。

*5 電視機完成所需的內部處理後，達到規定的待機功率。

*6 當您的電視機連接至網絡時，待機耗電量將有所增加。

註

- 選購配件的供應視國家 / 區域 / 電視機型號 / 存貨而定。
- 設計與規格可能變更而不事先通知。

商標資訊

- HDMI、HDMI 高畫質多媒體介面及 HDMI 標誌為 HDMI Licensing Administrator, Inc. 在美國及其他國家的商標或註冊商標。
- Dolby、杜比、Dolby Vision、Dolby Atmos、Dolby Audio 和雙 D 符號是杜比實驗室的商標。本產品經過杜比實驗室的許可而製造。未公佈的機密作品。版權所有 © 2012-2018 杜比實驗室。保留所有權利。
- Gracenote、Gracenote 標誌和標誌字型以及 “Powered by Gracenote” 標誌是 Gracenote, Inc. 在美國和 / 或其他國家的註冊商標或商標。
- Google、Google Play、Chromecast、YouTube、Android TV 和其他相關標記和徽標是 Google LLC 的商標。
- 有關 DTS 專利，請參閱 <http://patents.dts.com>。由 DTS, Inc. 授權製造。DTS、其標誌、DTS 連同其標誌、以及 Digital Surround 是 DTS, Inc. 在美國和 / 或其他國家的註冊商標或商標。© DTS, Inc. 保留所有權利。
- Netflix 是 Netflix, Inc. 的註冊商標。
- © 2019 RealNetworks, Inc. 保留所有權利。已頒發專利。RealMedia, RealNetworks 以及它們的標誌是 RealNetworks, Inc. 的商標或註冊商標。
- TUXERA 是 Tuxera Inc. 在美國及其他國家/地區的註冊商標。
- 所有其他商標屬於其各自的所有者。

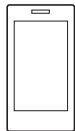

Support / 支援

<https://www.sony-asia.com/support>