

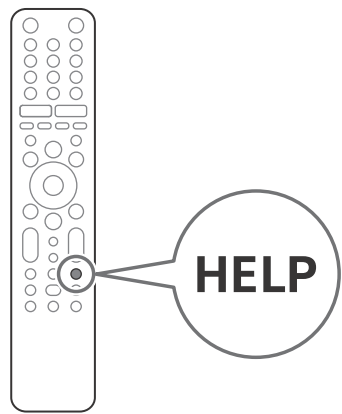

Television

Reference Guide



BRAVIA

KD-49X9500H

About Manuals

This TV comes with the following manuals. Please retain the manuals for future reference.

Setup Guide <ul style="list-style-type: none"> TV installation and setup. 	
Reference Guide (this manual) / Safety Documentation <ul style="list-style-type: none"> Safety information, remote control, troubleshooting, wall-mount installation, specification, etc. 	
Help Guide (On screen Manual) <ul style="list-style-type: none"> Settings, Android TV functions, Internet connection, troubleshooting, etc. To open it, press the HELP button on the remote control and select Help Guide. 	 <ul style="list-style-type: none"> You can refer to the Help Guide with your smartphone. https://rd1.sony.net/help/tv/hga1/h_ga/

IMPORTANT - Read the End User Software Licence Agreement before using your Sony product. Using your product indicates your acceptance of the End User Software Licence Agreement. The software licence agreement between you and Sony is available online at Sony website (<http://www.sony.net/tv-software-licenses/>) or on your product screen. Go to [Settings] → [Device Preferences] → [About] → [Legal information] → [Notices and licences].

- Note**
- Before operating the TV, please read the "Safety Information".
 - Read the supplied safety documentation for additional safety information.
 - Instructions about "Installing the TV to the Wall" are included within this TV's instruction manual.
 - Images and illustrations used in the Setup Guide and this manual are for reference only and may differ from the actual product.

Location of the identification label

Labels for the TV Model No. and Power Supply rating are located on the rear of the TV.

Safety Information

Installation/Set-up

Install and use the TV set in accordance with the instructions below in order to avoid any risk of fire, electric shock or damage and/or injuries.

Installation

- The TV set should be installed near an easily accessible AC power outlet (mains socket).
- Place the TV set on a stable, level surface to prevent it from falling over and causing personal injury or property damage.
- Install the TV where it cannot be pulled, pushed, or knocked over.
- Install the TV so that the TV's Table-Top Stand does not protrude out from the TV stand (not supplied). If the Table-Top Stand protrudes out from the TV stand, it may cause TV set to topple over, fall down, and cause personal injury or damage to the TV.

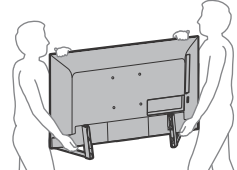
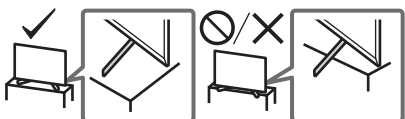

- When transporting the TV set, do not subject it to jolts or excessive vibration.
- When transporting the TV set for repairs or when moving, pack it using the original carton and packing material.

Topple prevention

(Models with supplied support belt kit)

Refer to the Setup Guide on top of the cushion. The supplied wood screw is only for affixing to a solid object made of wood.

(Except models with supplied support belt kit)

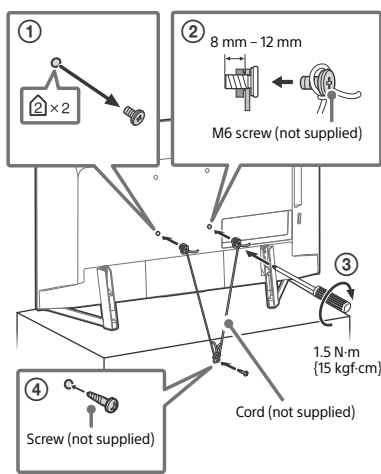

Notice for customer in UAE

TRA

REGISTERED No: ER63944/18
DEALER No: DA0065531/11

Remote Control and TV

The remote control shape, location, availability and function of remote control buttons may vary depending on your region/country/TV model.

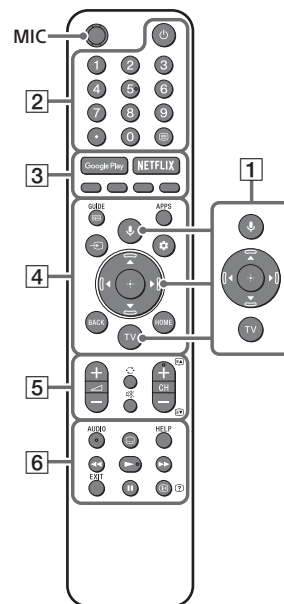

- Microphone:** Use the Google Assistant*1*2 or voice search*2. For hints on how to control your TV press (Microphone) button and speak the phrase "voice hints".*1
: On screen menu navigation and selection.
TV: Display TV channel list or switch to input.
- TV standby**
Number buttons
 (dot)
 (Text): Display text information.
- Google Play / NETFLIX*1*3 / Colour buttons**
- GUIDE/Menu:** Display the digital programme guide of TV or TV box*1*4.
APPS: Display a list of installed apps.
 (Input select): Display and select the input source, etc.
 (Quick settings): Display Quick Settings.
- BACK HOME**
- +/- (Volume)**
 (Jump)
 (Mute)*5
CH +/-/Channel/Previous page: Select the channel, or next (Channel) / previous (Previous page) page.
- AUDIO:** Select the sound of multilingual source or dual sound (depend on programme source).
 (Subtitle setting)
HELP: Display the Help menu.
 (Navigation icons)
EXIT
 (Info/Text reveal): Display information.

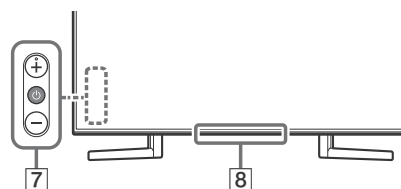

- (Power)/+/-**
- Remote Control sensor / Light sensor / Illumination LED**

- *1 Only on limited region/country/TV model/language.
- *2 The Google Assistant or voice search requires an Internet connection.
- *3 Installation might be required depending on region/country.
- *4 [TV box setup] setting is required.
- *5 Accessibility shortcut is available by pressing and holding (Mute).

HELP For more information, refer to the Help Guide.

Installing the TV to the Wall

Using the optional Wall-Mount Bracket (SU-WL450)* (not supplied)

To Customers:

For product protection and safety reasons, Sony strongly recommends that installation of your TV be performed by Sony dealers or licensed contractors. Do not attempt to install it yourself.

To Sony Dealers and Contractors:

Provide full attention to safety during the installation, periodic maintenance and examination of this product.

Wall-Mount Bracket Installation Information

This TV's instruction manual only provides the steps to prepare the TV for Wall-Mount installation before it is installed on the wall. For instructions on Wall-Mount Bracket installation, see the Installation Information (Wall-Mount Bracket) on the product page for your TV model.
<https://www.sony-asia.com/support>

Preparing for Wall-Mount Installation

Make sure to attach the Table-Top Stand before installing the TV to the wall by referring to the Setup Guide.

- Prepare the TV for the Wall-Mount Bracket before making cable connections.
- Follow the instruction guide provided with the Wall-Mount Bracket for your model. Sufficient expertise is required in installing this TV, especially to determine the strength of the wall for withstanding the TV's weight.
- Be sure to entrust the attachment of this product to the wall to Sony dealers or licensed contractors and pay adequate attention to safety during the installation. Sony is not liable for any damage or injury caused by mishandling or improper installation.
- The screws for Wall-Mount Bracket are not supplied.
- Only qualified service personnel should carry out wall-mount installations.
- For safety reasons, it is strongly recommended that you use Sony accessories, including:
 - Wall-Mount Bracket SU-WL450
- Be sure to use the screws supplied with the Wall-Mount Bracket when attaching the Wall-Mount Bracket to the TV set. The supplied screws are designed as indicated by illustration when measured from the attaching surface of the Wall-Mount Bracket.
 The diameter and length of the screws differ depending on the Wall-Mount Bracket model. Use of screws other than those supplied may result in internal damage to the TV set or cause it to fall, etc.

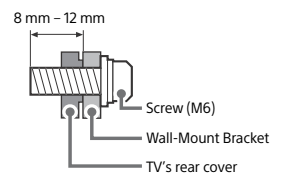

- Be sure to store the unused screws and Table-Top Stand in a safe place until you are ready to attach the Table-Top Stand. Keep the screws away from small children.

* Only on limited region/country/TV model.

Remove the screws from the rear of the TV.

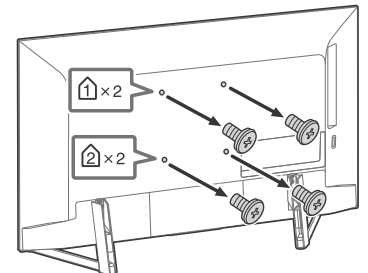

Troubleshooting

General troubleshooting for issues like: black screen, no sound, frozen picture, TV does not respond, or network is lost, do the following steps.

- Restart your TV by pressing the power button on the remote control for about five seconds. The TV will restart. If the TV does not recover, try unplugging the AC power cord (mains lead). Then press the power button on the TV, and release it. Wait for two minutes, and plug in the AC power cord (mains lead).
- Refer to the Help menu by pressing **HELP** on the remote control.

3 Connect your TV to the Internet and perform a software update. Sony recommends you to keep your TV software updated. Software updates provide new features and performance improvements.

4 Visit Sony support website (information provided at the end of this manual).

When you plug in the TV, the TV may not be able to turn on for a while even if you press the power button on the remote control or the TV.

It takes time to initialize the system. Wait for about one minute, then operate it again.

The remote control does not function.

- Replace the batteries.

The parental lock password has been forgotten.

- Enter 9999 for the PIN and enter the new PIN.

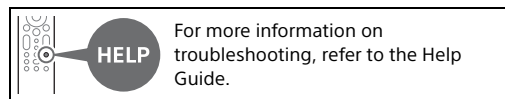

Specifications

System

Panel system: LCD (Liquid Crystal Display) Panel, LED Backlight

TV system: Depend on your country/area selection

Analogue: B/G, I, D/K, M

Digital: DVB-T/DVB-T2

Colour system: PAL/SECAM/NTSC3.58/NTSC4.43

Channel coverage: Depend on your country/area selection

Analogue: UHF/VHF/Cable

Digital: UHF/VHF

Sound output: 10 W + 10 W

Wireless technology

Protocol IEEE 802.11a/b/g/n/ac

(IEEE 802.11ac may not be available depending on countries/regions.)

Bluetooth® Version 4.2

Input/Output jacks

Antenna (aerial)/cable

75 ohm external terminal for VHF/UHF

VIDEO IN

Video/Audio input (mini jack)

HDMI IN 1/2/3/4 (support 4K resolution, HDCP

2.3-compatible)

Video:

4096 × 2160p (50, 60 Hz)^{*1+2}, 4096 × 2160p (24 Hz)^{*1}, 3840 × 2160p (50, 60 Hz)^{*2}, 3840 × 2160p (24, 25, 30 Hz), 1080p (30, 50, 60, 100, 120 Hz), 1080/24p, 1080i (50, 60 Hz), 720p (30, 50, 60 Hz), 720/24p, 576p, 480p, PC Formats^{*3}

Audio:

In eARC (Enhanced Audio Return Channel) mode

Refer to the Help Guide for details.

Except eARC mode

5.1 channel linear PCM: 32/44.1/48/88.2/96/

176.4/192 kHz 16/20/24 bits, Dolby Audio, Dolby

Atmos, DTS

eARC/ARC (Enhanced Audio Return Channel/Audio

Return Channel) (HDMI IN 3 only)^{*4}

In eARC mode

Refer to the Help Guide for details.

In ARC mode

Two channel linear PCM: 48 kHz 16 bits, Dolby

Audio, Dolby Atmos, DTS

DIGITAL AUDIO OUT (OPTICAL)

Digital optical jack (Two channel linear PCM: 48 kHz

16 bits, Dolby Audio, DTS)

(Stereo mini jack)

Headphone

USB 1, 2, 3

USB port 1 and 2 support High Speed USB (USB 2.0)

USB port 3 supports Super Speed USB (USB 3.1 Gen 1)

LAN

10BASE-T/100BASE-TX connector (Depending on the operating environment of the network, connection speed may differ. The communication rate and quality are not guaranteed.)

Power and others

Power requirements

110 V – 240 V AC, 50/60 Hz

Screen size (measured diagonally) (Approx.)

49 inches / 123.2 cm

Power consumption

Indicated on the rear of the TV

Standby power consumption^{*5*6}

0.5 W

Display resolution

3,840 pixels (horizontal) × 2,160 lines (vertical)

Output Rating

USB 1/2

5 V ---, 500 mA MAX

USB 3

5 V ---, 900 mA MAX

Dimensions (Approx.) (w × h × d) (mm)

with Table-Top Stand (without Table-Top Stand)

1,093 × 699 × 261 (1,093 × 629 × 69)

Mass (Approx.) (kg)

with Table-Top Stand (without Table-Top Stand)

14.4 (13.3)

Others

Optional accessories

Wall-Mount Bracket: SU-WL450

Operating temperature: 0 °C – 40 °C

*1 When 4096 × 2160p is input and [Wide mode] is set to [Normal], the resolution is displayed as 3840 × 2160p. To display 4096 × 2160p, set [Wide mode] setting to [Full 1] or [Full 2].

*2 To support 18 Gbps, set [HDMI signal format] to [Enhanced format].

*3 Refer to the online Help Guide for details.

*4 Connect your audio system to the HDMI IN 3 to route TV audio to your audio system.

*5 Specified standby power is reached after the TV finishes necessary internal processes.

*6 Standby power consumption will increase when your TV is connected to the network.

Note

- Optional accessories availability depends on countries/region/TV model/stock.
- Design and specifications are subject to change without notice.
- Subscriptions for services and applications may be required and additional terms, conditions and/or charges may apply when using the Google Assistant.

Notes on Digital TV function

- Any functions related to Digital TV (DVB) will only work in countries or areas where DVB-T/DVB-T2 (MPEG-2 and H.264/MPEG-4 AVC) digital terrestrial signals are broadcast. Please confirm with your local dealer if you can receive a DVB-T/DVB-T2 signal where you live.
- This TV set complies with DVB-T/DVB-T2 specifications, but compatibility with future DVB-T/DVB-T2 digital terrestrial broadcasts are not guaranteed.
- Some Digital TV functions may not be available in some countries/areas.

Trademark Information

- The terms HDMI, HDMI High-Definition Multimedia Interface, and the HDMI Logo are trademarks or registered trademarks of HDMI Licensing Administrator, Inc.
- Dolby, Dolby Vision, Dolby Atmos, Dolby Audio, and the double-D symbol are trademarks of Dolby Laboratories. Manufactured under license from Dolby Laboratories. Confidential unpublished works. Copyright © 2012-2018 Dolby Laboratories. All rights reserved.
- Gracenote, the Gracenote logo and logotype, "Powered by Gracenote" logo are either registered trademarks or trademarks of Gracenote, Inc. in the United States and/or other countries.
- Google, Google Play, Chromecast, YouTube, Android TV and other related marks and logos are trademarks of Google LLC.
- For DTS patents, see <http://patents.dts.com>. Manufactured under license from DTS, Inc. DTS, the Symbol, DTS and the Symbol together, and Digital Surround are registered trademarks or trademarks of DTS, Inc. in the United States and/or other countries. © DTS, Inc. All Rights Reserved.
- Netflix is a registered trademark of Netflix, Inc.
- TUXERA is a registered trademark of Tuxera Inc. in the US and other countries.
- All other trademarks are the property of their respective owners.

