

# Home Theatre System

## Operating Instructions

## Parts and Controls

### What's in the Box

- Bar speaker (1)
- Subwoofer (1)
- Surround speaker (2)
- Remote control (1) / R03 (size AAA) battery (2)
- AC power cord (mains lead) (2) (supplied for Middle East and Africa models)
- AC power cord (mains lead) (1) (supplied for other countries/regions)
- Stereo Mini cable (1) (supplied for India models only)
- Optical digital cable (1) (supplied for models other than India models)
- WALL MOUNT TEMPLATE (1) (not supplied for some countries/regions)
- Startup Guide
- Operating Instructions (this document)



HT-S20R

## About These Operating Instructions

- The instructions in these Operating Instructions describe the controls on the remote control.
- Some illustrations are presented as conceptual drawings, and may be different from the actual products.
- The default settings are underlined on each feature description.
- Characters in brackets [ ] appear in the front panel display or on the TV screen.

## Installation and Connection

### Connecting a TV with an HDMI Cable and/or Optical Cable

Refer to Startup Guide (separate document).

### Mounting the Bar Speaker and Surround Speakers on a Wall

You can mount the bar speaker and surround speakers on a wall.

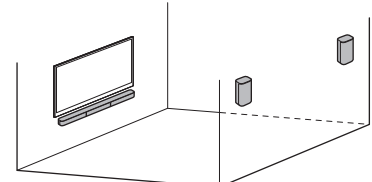

#### Notes

- Prepare screws (not supplied) that are suitable for the wall material and strength. As a plasterboard wall is especially fragile, attach the screws securely in the wall beam. Install the speakers horizontally, hung by screws in studs in a continuous flat section of the wall.
- Have the installation done by a Sony dealer or licensed contractor and pay special attention to safety during the installation.
- Sony shall not be held responsible for accidents or damage caused by improper installation, insufficient wall strength, improper screw installation or natural disaster, etc.

### Mounting the Bar Speaker on a Wall

1 Prepare two screws (not supplied) that are suitable for the wall mount holes on the rear of the bar speaker.

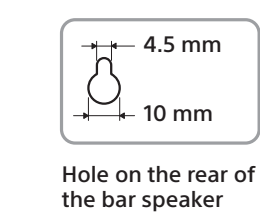
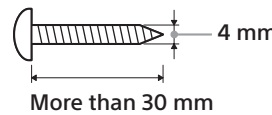

2 Stick WALL MOUNT TEMPLATE on a wall.

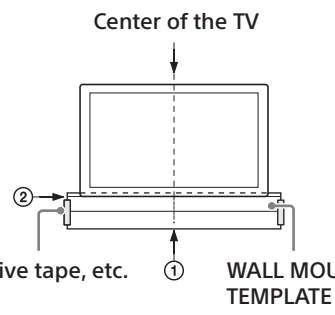

1 Align TV CENTER LINE (⊙) of WALL MOUNT TEMPLATE with the center line of your TV.

2 Align TV BOTTOM LINE (⊖) of WALL MOUNT TEMPLATE with the bottom of your TV, then stick WALL MOUNT TEMPLATE on a wall by using a commercially available adhesive tape, etc.

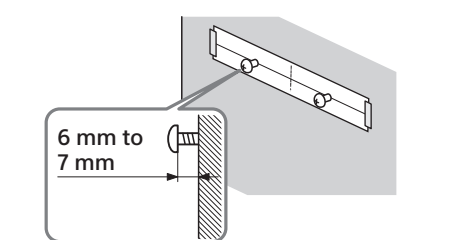
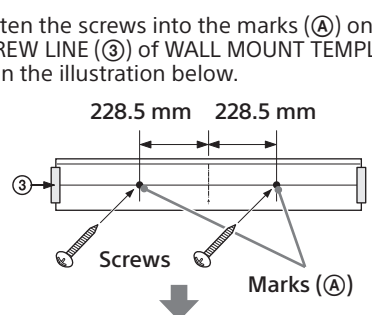

The screw should protrude as in the illustration.

4 Remove WALL MOUNT TEMPLATE.

5 Hang the bar speaker on the screws.

Align the holes on the rear of the bar speaker with the screws, then hang the bar speaker on the two screws.

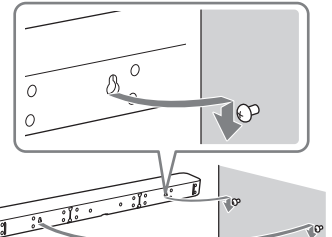

**Note**  
When sticking WALL MOUNT TEMPLATE, smooth it out fully.

### Mounting the Surround Speakers on a Wall

1 Prepare a screw (not supplied) for each speaker that is suitable for the wall mount hole on the rear of the surround speaker.

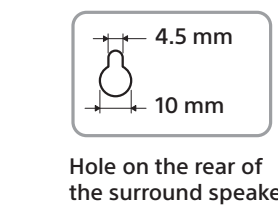
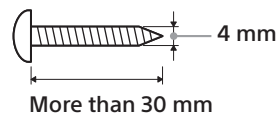

2 Fasten the screw into the wall.

The screw should protrude as in the illustration.

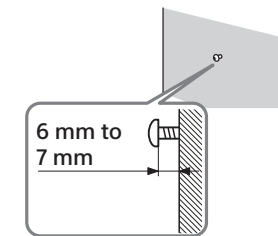

3 Hang the surround speaker on the screw.

Align the hole on the rear of the surround speaker with the screw, then hang the surround speaker on the screw.

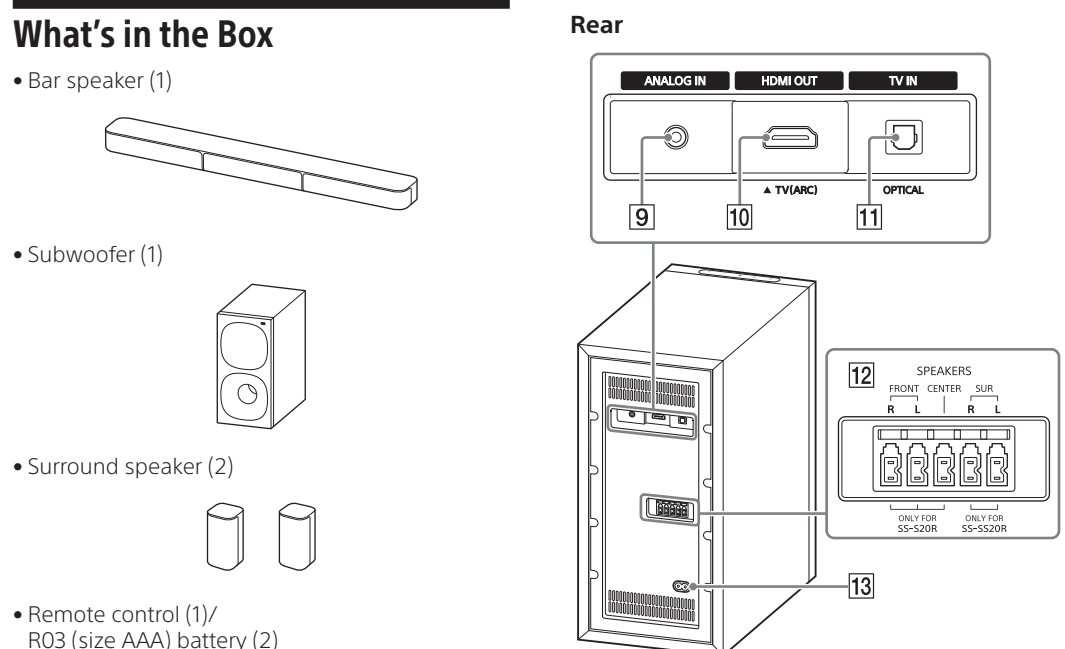
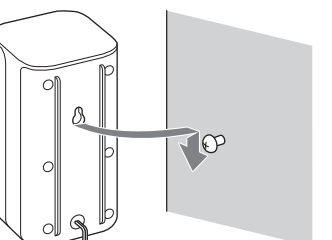

- 9** ANALOG IN jack  
**10** HDMI OUT (TV (ARC)) jack  
Connect a TV that has an HDMI input jack with an HDMI cable. The system is compatible with Audio Return Channel (ARC), ARC is the function that sends TV sound to an AV device such as the system from the TV's HDMI jack.
- 11** TV IN (OPTICAL) jack  
**12** SPEAKERS jacks  
**13** AC inlet

### Remote Control

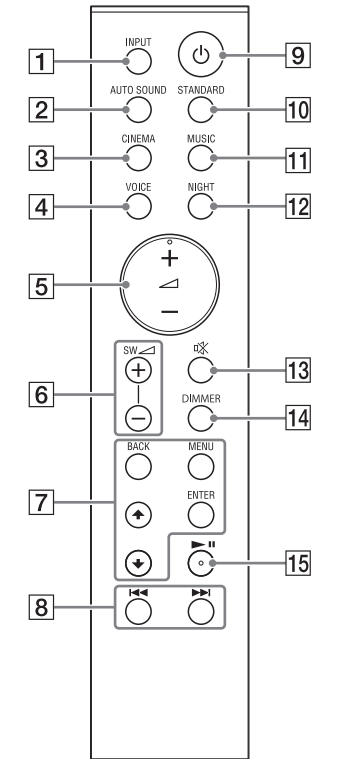

- 1 **INPUT**  
Selects the input source. Each time you press INPUT, the input source changes cyclically as follows. [TV] → [ANALOG] → [BT] → [USB]
- 2 **AUTO SOUND**  
Selects AUTO SOUND for the sound mode.
- 3 **CINEMA**  
Selects CINEMA for the sound mode.
- 4 **VOICE**  
Turns on/off the voice mode.
- 5 **[volume] +/-**  
Adjusts the volume.
- 6 **SW [subwoofer volume] +/-**  
Adjusts the subwoofer volume.
- 7 **MENU**  
Turns on/off the menu in the front panel display.

- 8 **[M] (mute)**  
Selects the menu items. Selects the content on the TV screen for USB playback.
- 9 **ENTER**  
Enters the selection. Plays the content that is selected by **[M]** for USB playback.
- 10 **BACK**  
Returns to the previous display. Stops USB playback.
- 11 **[REPEAT]** (previous/next)  
Selects the previous/next track or file. Hold down to search backward or forward for USB playback.
- 12 **[power]**  
Turns on the system or sets it to standby mode.
- 13 **STANDARD**  
Selects STANDARD for the sound mode.
- 14 **MUSIC**  
Selects MUSIC for the sound mode.
- 15 **NIGHT**  
Turns on/off the night mode.
- 16 **[Muting]**  
Mutes the sound temporarily. Pressing the button while muting cancels muting.
- 17 **DIMMER**  
Adjusts the brightness of the front panel display and BLUETOOTH indicator. Each time you press DIMMER, the brightness setting changes cyclically as follows. [BRIGHT] → [DARK] → [OFF].
- 18 **[play/pause]**  
Plays, pauses, or resumes playback. The **[play/pause]** and **[play/pause]** buttons have a tactile dot. Use it as a guide during operation.

## Guide to Parts and Controls

### Subwoofer

#### Front

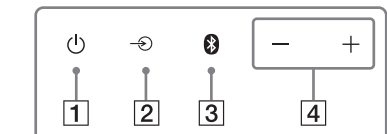

- 1 **[power]** button  
Turns on the system or sets it to standby mode.
- 2 **[input select]** button  
3 **BLUETOOTH** button  
4 **+/- (volume)** buttons  
5 **BLUETOOTH** indicator  
– Lights in blue: BLUETOOTH connection has been established.  
– Flashes slowly in blue repeatedly: BLUETOOTH connection is being attempted.  
– Flashes twice in blue repeatedly: During pairing standby status.
- 6 **Front panel display**  
7 **[USB]** port  
8 **Remote control sensor**  
Point the remote control at the remote control sensor to operate the system.

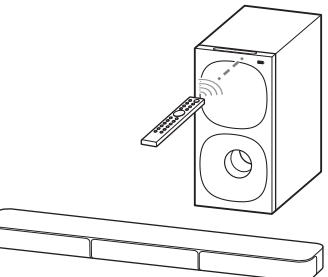

**About the replacement of batteries for the remote control**  
When the system does not respond by operating with the remote control, replace two batteries with new batteries. Use R03 (size AAA) manganese batteries for replacement.

## Listening to Music/Sound

### Listening to a TV

You can listen to TV sound on the system.

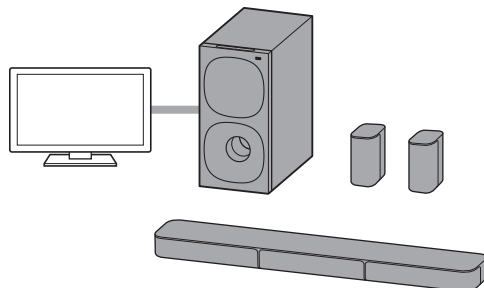

### When Connecting to a TV with an HDMI Cable (ARC) or Optical Digital Cable

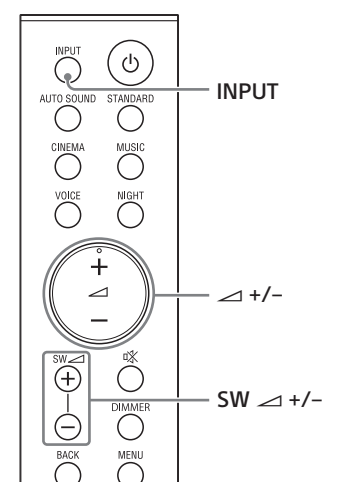

- 1 Press **INPUT** repeatedly to select [TV] in the front panel display.
- 2 Adjust the volume.
- Adjust the volume by pressing **[+/-]** on the remote control.
  - Adjust the subwoofer volume by pressing **SW +/-** on the remote control.

**Notes**

- When you connect the TV to both the HDMI OUT (TV (ARC)) and TV IN (OPTICAL) jacks, the jack for audio input is selected depending on which audio signal is input first.
- When the input source does not contain much bass sound, such as in TV programs, the bass sound from the subwoofer may be difficult to hear.

**Tip**  
You can also select the input by pressing **[input select]** on the subwoofer.

### When Connecting to a TV with a Stereo Mini Cable

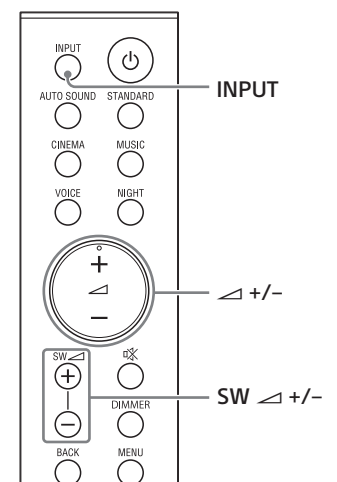

- 1 Press **INPUT** repeatedly to select [ANALOG] in the front panel display.
- 2 Adjust the volume.
- Adjust the volume by pressing **[+/-]** on the remote control.
  - Adjust the subwoofer volume by pressing **SW +/-** on the remote control.

**Note**  
When the input source does not contain much bass sound, such as in TV programs, the bass sound from the subwoofer may be difficult to hear.

**Tip**  
You can also select the input by pressing **[input select]** on the subwoofer.

### Listening to Music on a USB Device

You can play music files stored on a connected USB device.

- Notes**
- To view the USB content list on the TV screen, make sure you connect the system to the TV using an HDMI cable.
  - Change the input of the TV to the input to which the system is connected.

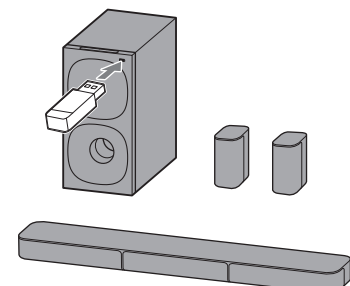

### Listening to Music on a Connected USB Device

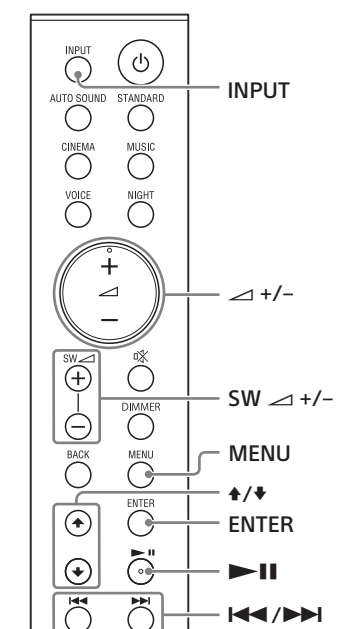

- 1 Connect the USB device to the **[USB]** port.

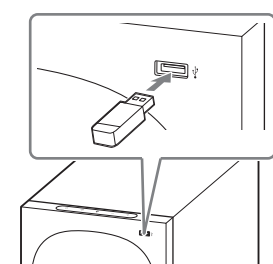

- 2 Press **INPUT** repeatedly to select [USB] in the front panel display.  
[READ] appears in the front panel display and the system starts reading data of the USB device. When the reading of data is completed, the USB content list appears on the TV screen.
- 3 Press **[+/-]** to select the content you want, then press **ENTER**.  
The selected content starts playing.
- 4 Adjust the volume.
- Adjust the volume by pressing **[+/-]** on the remote control.
  - Adjust the subwoofer volume by pressing **SW +/-** on the remote control.

**Note**  
When the input source does not contain much bass sound, such as in TV programs, the bass sound from the subwoofer may be difficult to hear.

**To select the play mode**  
You can select the play mode for USB playback, such as repeat play or random play, from the menu.

- 1 Press **MENU**.  
The menu item appears in the front panel display.
- 2 Select **[USB] - [REPEAT]** by using **[+/-]**/ENTER.
- 3 Select the play mode by using **[+/-]**/ENTER.
- [OFF]: Repeats off. Plays back all tracks.
  - [ONE]: Repeats one track.
  - [FOLDER]: Repeats all tracks in a current folder.
  - [RANDOM]: Repeats all tracks in a current folder in random order.
  - [ALL]: Repeats all tracks.
- 4 Press **MENU** to turn off the menu.

#### Other operations

To	Do this
Pause or resume playback	Press <b>[play/pause]</b> .
Select the previous or next track	Press <b>[REWIND]</b> or <b>[FWD]</b> .
Search backward or forward (rewind/fast forward)	Press and hold <b>[REWIND]</b> or <b>[FWD]</b> .

- Notes**
- Do not remove the USB device during operation. To avoid data corruption or damage to the USB device, turn the system off before connecting or removing the USB device.
  - INVALID USB appears in the front panel display if you connect an unsupported or broken USB device.
  - Depending on the file format, rewind and fast forward may not work.

### Information of USB Device on the TV Screen

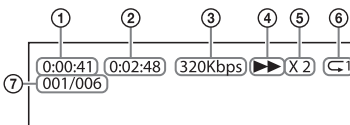

- ① Playing time
- ② Total playing time
- ③ Bit rate
- ④ Playback status
- ⑤ Rewind/fast forward speed
- ⑥ Play mode
- ⑦ Selected file index/Total files in the folder

The following messages appear on the TV screen depending on the status of the USB device.

- [File Unsupported]  
Appears for 2 seconds at the bottom left side when an unsupported file is skipped.
- [Device Not Support]  
– A USB device is not supported.  
– Device inserted is a non-USB device, a bad USB device, or a USB device that has no files on it.
- [No USB]  
No USB device is inserted.
- [Waiting]  
The system is searching the USB device.
- [This device is empty]  
There are no playable files in the USB device.

**Notes**

- Depending on the playback source, some information may not be displayed.
- Depending on the play mode, the information displayed may differ.

### Listening to Music from a Mobile Device with the BLUETOOTH Function

You can listen to music stored on a mobile device such as a smartphone or tablet via a wireless connection by connecting the system and the mobile device with the BLUETOOTH function. When connecting to the mobile device with the BLUETOOTH function, you can operate by simply using the supplied remote control without turning the TV on.

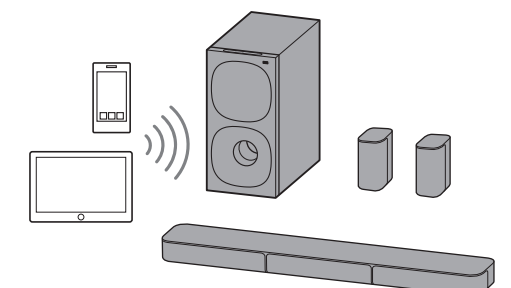

### Pairing with a Mobile Device

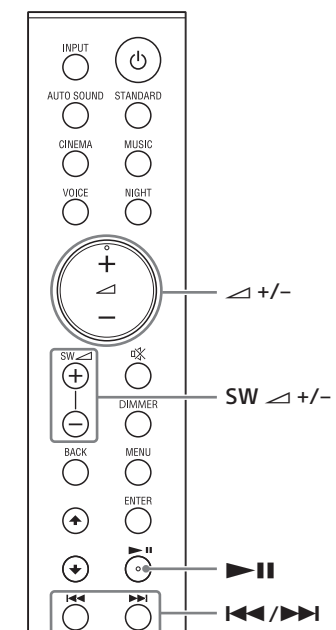

- 1 Press and hold the **BLUETOOTH** button on the subwoofer for 2 seconds.  
The system enters the pairing mode and the BLUETOOTH indicator flashes twice repeatedly.

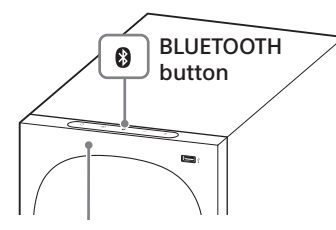

2 On the mobile device, search for the system by performing the pairing operation.  
The list of the BLUETOOTH devices that are searched appears on the screen of the mobile device.

3 Pair the system and mobile device by selecting "HT-S20R" from the list on the screen of the mobile device.  
If a passkey is requested, enter "0000."

4 Make sure that the BLUETOOTH indicator on the subwoofer lights in blue.

5 Start audio playback with the music app on the connected mobile device.  
Sound is output from the system.

- 6 Adjust the volume.
- Adjust the volume by pressing **[+/-]** on the remote control.
  - Adjust the subwoofer volume by pressing **SW +/-** on the remote control.
  - **[play/pause]** and **[play/pause]** on the remote control can be used for the BLUETOOTH function. (Searching backward or forward by holding down **[REWIND]** or **[FWD]** does not work.)

**Notes**

- You can pair up to 10 BLUETOOTH devices. If an 11th BLUETOOTH device is paired, the oldest connected device will be replaced by the new one.
- Perform pairing for the second and subsequent mobile devices.
- When the input source does not contain much bass sound, such as in TV programs, the bass sound from the subwoofer may be difficult to hear.

**Tips**

- You can check the connection status of the BLUETOOTH function by checking the BLUETOOTH indicator status.
- While the BLUETOOTH input is being selected, the system enters the pairing mode by pressing the BLUETOOTH button on the subwoofer shortly.

### Listening to Music of the Paired Mobile Device

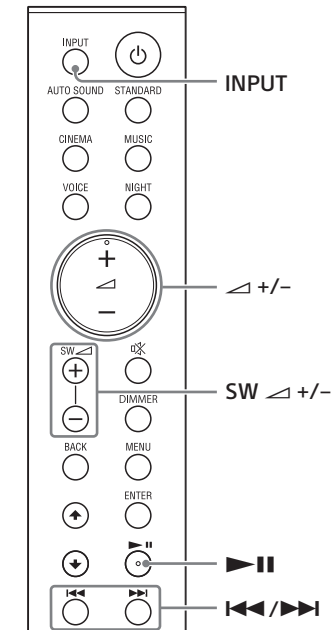

- 1 Turn the BLUETOOTH function of the mobile device to on.
- 2 Press **INPUT** repeatedly to select [BT] or press the BLUETOOTH button on the subwoofer shortly.  
The BLUETOOTH indicator flashes and the system automatically reconnects to the BLUETOOTH device it was most recently connected to.
- 3 Make sure that the BLUETOOTH indicator lights in blue.  
A connection between the system and mobile device has been established.
- 4 Start audio playback with the music app on the connected mobile device.  
Sound is output from the system.
- 5 Adjust the volume.
- Adjust the volume by pressing **[+/-]** on the remote control.
  - Adjust the subwoofer volume by pressing **SW +/-** on the remote control.
  - **[play/pause]** and **[play/pause]** on the remote control can be used for the BLUETOOTH function. (Searching backward or forward by holding down **[REWIND]** or **[FWD]** does not work.)

**Note**  
When the input source does not contain much bass sound, such as in TV programs, the bass sound from the subwoofer may be difficult to hear.

## Adjusting the Sound

### Enjoying the Sound Effect that is Tailored to Sound Sources (Sound Mode)

You can easily enjoy pre-programmed sound effects that are tailored to different kinds of sound sources.

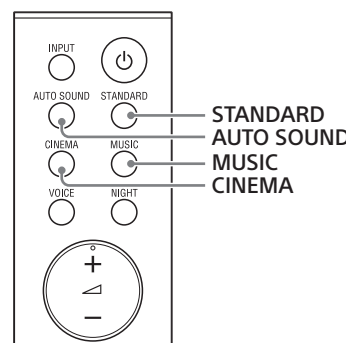

Press **AUTO SOUND**, **CINEMA**, **MUSIC**, or **STANDARD** to select the sound mode. The selected sound mode appears in the front panel display.

Front panel display	Explanation
[AUTO SOUND]	You can enjoy the sound with Sony-recommended sound mode. The sound mode is automatically optimized according to playback content and function.
[STANDARD]	Sound effects are optimized for the individual source.
[CINEMA]	Sounds are played back with surround effects, and they are realistic and powerful, making them suitable for movies.
[MUSIC]	Sound effects are optimized for listening to music.

### Making Dialogs Clearer (VOICE)

You can make dialogs clearer by setting the voice mode.

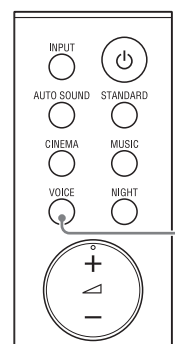

Press **VOICE** to set the function to on or off.

Front panel display	Explanation
[Vo.ON]	The sound of voice is emphasized.
[Vo.OFF]	Off.

### Enjoying Clear Sound with Low Volume at Midnight (NIGHT)

You can compress sound in accordance with the information contained in the content by setting the night mode to on. Sound is output at low volume with minimum loss of fidelity and clarity of dialog.

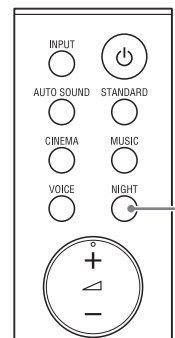

Press **NIGHT** to set the function to on or off.

Front panel display	Explanation
[N.ON]	The sound is compressed in accordance with the information contained in the content.
[N.OFF]	Off.

**Note**  
When you turn the system off, the night mode is set to off automatically.

### Checking the Current Sound Settings

You can check the settings of the sound, night, and voice modes and current stream information.

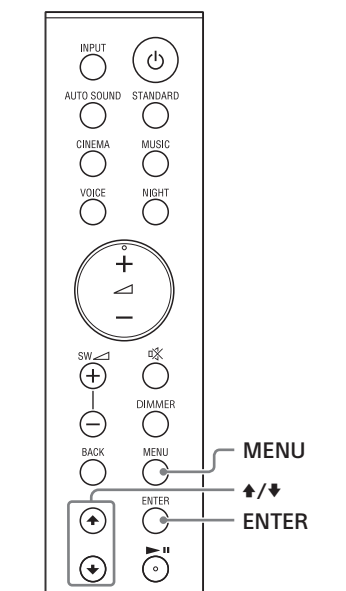

- 1 Press **MENU** to turn on the menu in the front panel display.
- 2 Press **[+/-]** to select [CURRENT STATUS], then press **ENTER**.
- 3 Press **[+]** repeatedly to select the item you want.  
The current setting appears in the following order.  
Sound mode → Voice mode → Night mode → Stream Information  
The current setting appears in the reverse order by pressing **[+]**.
- 4 Press **MENU** to turn off the menu.



## Changing the Settings

You can set the following items on the menu. Your settings are retained even if you disconnect the AC power cord (mains lead).

- Press **MENU** to turn on the menu in the front panel display.
- Press **◀/▶/ENTER** repeatedly to select the item and setting you want. To return to the upper layer, press **BACK**.
- Press **MENU** to turn off the menu.

**Note** You can also turn off the menu by performing an operation other than a menu operation such as pressing ↶/↷, **SW**, ↶/↷, **⏏**, etc.

#### Menu List

The default settings are underlined. They may differ depending on the area.

Items		Function
<b>[CURRENT STATUS]</b>	[AUTO SOUND]/[STANDARD]/[CINEMA]/[MUSIC]	These items are not the setting menu items. You can check the settings of the sound, night, and voice modes and current stream information.
	[Vo. ON]/[Vo. OFF]	For details about operation, see “Checking the Current Sound Settings.”
	[N. ON]/[N. OFF]	
	[NO INFO.]/[LPCM]/[DOLBY DIGITAL]	
<b>[SPEAKER]</b>	[MULTI SPEAKER]	You can set the output of the speakers of the system. <ul style="list-style-type: none"><li><b>[ON]</b>: The sound is output from all the speakers, regardless of the number of audio channels for the playback source.</li> <li><b>[OFF]</b>: The sound is output from the speakers that correspond to the audio channel for the playback source.</li></ul>
	[SUR.L.DISTANCE]/[SUR.R.DISTANCE]	[3.0M]: Adjusts the distance from the seating position to the surround speaker (left or right) from 1.0 meter to 6.0 meters (0.1 meter intervals).
	[SUR.L.LEVEL]/[SUR.R.LEVEL]	[0.0]: Adjusts the sound level of the surround speaker (left or right) from −6.0 dB to +6.0 dB (0.5 dB intervals).
	[TEST TONE]	<b>Note</b> Be sure to set [TEST TONE] to [ON] for easy adjustment. <ul style="list-style-type: none"><li><b>[ON]</b>: The test tone is output from each speaker in sequence.</li> <li><b>[OFF]</b>: Turns off the test tone.</li></ul>
		<b>Note</b> The test tone is not output even though [TEST TONE] is set to [ON] while [USB] input is selected. Select an input other than [USB].
<b>[AUDIO]</b>	[DRC] (Dynamic range control)	Useful for enjoying movies at low sound volume. DRC applies to Dolby Digital sources. <ul style="list-style-type: none"><li><b>[ON]</b>: Compresses sound according to the information in the content.</li> <li><b>[OFF]</b>: Sound is not compressed.</li></ul>
	[AVOL.] (Auto volume)	You can adjust the volume automatically depending on the input level from a connected device. <ul style="list-style-type: none"><li><b>[ON]</b>: Adjusts the volume automatically.</li> <li><b>[OFF]</b>: Off.</li></ul>
	[DUAL] (Dual mono)	You can enjoy multiplex broadcast sound when the system receives a Dolby Digital multiplex broadcast signal. <ul style="list-style-type: none"><li><b>[MAIN]</b>: Sound of the main language will be output.</li> <li><b>[SUB]</b>: Sound of the sub language will be output.</li> <li><b>[M/S]</b>: Mixed sound of both the main and sub languages will be output.</li></ul>
		<b>Note</b> To receive a Dolby Digital signal, you need to connect a TV or other device to the TV IN (OPTICAL) jack with an optical digital cable or the HDMI OUT (TV ARC) jack with an HDMI cable.
<b>[HDMI]</b>	[CONTROL FOR HDMI]	<b>[ON]</b> : The Control for HDMI function is enabled. Devices connected with an HDMI cable can operate each other. <ul style="list-style-type: none"><li><b>[OFF]</b>: Off.</li></ul>
	[TV AUDIO]	You can set whether the playback sound that is input from an HDMI cable or optical digital cable. <ul style="list-style-type: none"><li><b>[AUTO]</b>: Plays the sound that is detected from either an HDMI cable or optical digital cable. When you connect either an HDMI cable or optical digital cable, the system plays by selecting the connected cable for the TV input.</li> <li><b>[OPTICAL]</b>: Plays the sound from the TV IN (OPTICAL) jack for the TV input.</li></ul>
<b>[BT]</b>	[POWER]	You can turn the BLUETOOTH function on or off. <ul style="list-style-type: none"><li><b>[ON]</b>: Turns the BLUETOOTH function on.</li> <li><b>[OFF]</b>: Turns the BLUETOOTH function off.</li></ul>
		<b>Note</b> When the BLUETOOTH function is set to off, the BLUETOOTH input is skipped while selecting input by pressing <b>INPUT</b> .
	[STANDBY]	When the system has pairing information, you can turn the system on and listen to music from a BLUETOOTH device, even when the system is in standby mode, by setting the BLUETOOTH standby mode to on. <ul style="list-style-type: none"><li><b>[ON]</b>: BLUETOOTH standby mode is enabled.</li> <li><b>[OFF]</b>: BLUETOOTH standby mode is disabled.</li></ul>
		<b>Note</b> While the BLUETOOTH standby mode is on, standby power consumption increases.
<b>[USB]</b>	[REPEAT]	<b>[OFF]</b> : Repeats off. Plays back all tracks. <ul style="list-style-type: none"><li><b>[ONE]</b>: Repeats one track.</li> <li><b>[FOLDER]</b>: Repeats all tracks in a current folder.</li> <li><b>[RANDOM]</b>: Repeats all tracks in a current folder in random order.</li> <li><b>[ALL]</b>: Repeats all tracks.</li></ul>
<b>[SYSTEM]</b>	[AUTO STANDBY]	<b>[ON]</b> : Turns on the auto standby function. When you do not operate the system for about 20 minutes, the system enters standby mode automatically. <ul style="list-style-type: none"><li><b>[OFF]</b>: Off.</li></ul>
	[VERSION]	The current firmware version information appears in the front panel display.
<b>[RESET]</b>	[ALL RESET]	You can reset the system settings to the factory default. For details, see “Resetting the System.”
<b>[UPDATE]</b>	[START]	Start the software update after connecting the USB memory on which the software update file is stored to the system. For information about the software updates, visit the following website: https://www.sony-asia.com/software/support
		<b>Note</b> You can update the software of the system by pressing and holding <span>↶</span> and BLUETOOTH on the subwoofer for 7 seconds.
	[CANCEL]	Cancels the software update.

## Using the Control for HDMI Function

Connecting a device such as a TV or Blu-ray Disc player compatible with the Control for HDMI function\* using an HDMI cable enables you to easily operate the device by using a TV or Blu-ray Disc player remote control.

**Note** These functions may work with devices other than those manufactured by Sony, but operation is not guaranteed. \* Control for HDMI is a standard used by CEC (Consumer Electronics Control) for allowing HDMI (High-Definition Multimedia Interface) devices to control each other.

#### Preparing to Use the Control for HDMI Function

Set [HDMI] – [CONTROL FOR HDMI] to [ON]. The default setting is [ON].

Enable the Control for HDMI function settings of the TV and other device connected to the TV.

**Tip** If you enable the Control for HDMI function when using a TV manufactured by Sony, the Control for HDMI function of the system is also enabled automatically.

#### System Power Off Function

When you turn off the TV, the system will turn off automatically.

#### System Audio Control Function

If you turn on the system while you are watching the TV, the TV sound will be output from the speakers of the system. The volume of the system can be adjusted using the TV remote control. If the TV sound was output from the speakers of the system the previous time you watched the TV, the system will be turned on automatically when you turn on the TV again.

Operations can also be made by the TV’s menu. For details, refer to the operating instructions of your TV.

- Sound** is only output from the TV if other than [TV] input is selected when using the Twin Picture function on the TV. When you disable the Twin Picture function, the sound is output from the system.
  - The number for the system’s volume level is displayed on the TV screen depending on the TV. The volume number displayed on the TV may differ from the number on the front panel display of the system.
  - Depending on the settings of the TV, the System Audio Control function may not be available. For details, refer to the operating instructions of your TV.
  - Depending on the TV, if the TV sound was output from the speakers of the TV the previous time you watched the TV, the system may not turn on by interlocking with the TV power even if the TV is turned on.

#### Audio Return Channel (ARC)

If the system is connected to a TV’s HDMI IN jack compatible with Audio Return Channel, you can listen to TV sound from the speakers of the system without connecting an optical digital cable.

**Note** If the TV is not compatible with Audio Return Channel, an optical digital cable needs to be connected (refer to the supplied StartUp Guide).

#### One-Touch Play Function

When you play content on a device (Blu-ray Disc player, “PlayStation™4”, etc.) connect to the TV, the system and TV are turned on automatically, the input of the system is switched to the TV input, and sound is output from the speakers of the system.

#### Notes

- If the TV sound was output from the speakers of the TV the previous time you watched the TV, the system may not turn on and the sound and picture may be output from the TV even if device content is played.
- Depending on the TV, the beginning part of content being played may not play correctly.

## Notes on HDMI Connections

- Use an HDMI-authorized cable.
- Use a Sony High Speed HDMI cable with the Cable Type Logo.
- We do not recommend using an HDMI-DVI conversion cable.
- Check the setup of the connected device if an image is poor or the sound is not coming out of the device connected via the HDMI cable.
- Audio signals (sampling frequency, bit length, etc.) transmitted from an HDMI jack may be suppressed by the connected device.

## Saving Power Consumption

To use the system with saving power consumption, change the following settings.

#### Turning the System Off by Detecting the Using State

When you set the auto standby function to on, the system enters standby mode automatically when you do not operate the system for about 20 minutes and the system is not receiving an input signal.

Set [SYSTEM] – [AUTO STANDBY] to [ON]. The default setting is [OFF].

#### Saving Power in Standby Mode

To save power consumption during the standby mode, set [BT] – [STANDBY] and [HDMI] - [CONTROL FOR HDMI] to [OFF]. The default settings for them are [ON].

## Resetting the System

If the system does not operate properly, reset the system as follows.

- Press **MENU** to turn on the menu in the front panel display.
- Press **◀/▶** to select [RESET], then press **ENTER**.
- Press **◀/▶** to select [ALL RESET], then press **ENTER**.
- Press **◀/▶** to select [START], then press **ENTER**. All the settings return to their initial status.

#### To cancel resetting

Select [CANCEL] in step 4.

#### If You Cannot Perform Resetting Using the Subwoofer

Press and hold ↶ and – (volume) on the subwoofer for more than 5 seconds. All the settings return to their initial status.

**Tip** The default settings are underlined on each feature description.

## Troubleshooting

If the system does not work properly, handle it in the following order.

- Search for the cause and solution of the issue using this troubleshooting.**

- Reset the system.**

All the settings of the system return to their initial status. For details, see “Resetting the System.”

Should any problems persist, consult your nearest Sony dealer.

#### Power

**The system does not power up.**

- Check that the AC power cord (mains lead) is connected securely.
- Disconnect the AC power cord (mains lead) from the wall outlet (mains), and then reconnect after several minutes.

**The system is turned off automatically.**

- The auto standby function is working. Set [SYSTEM] – [AUTO STANDBY] to [OFF].

**The system does not turn on even when the TV is turned on.**

• Set [HDMI] – [CONTROL FOR HDMI] to [ON]. The TV must support the Control for HDMI function. For details, refer to the operating instructions of your TV.

• Check the speaker settings of the TV. The system power syncs with the speaker settings of the TV. For details, refer to the operating instructions of your TV.

• Depending on the TV, if the sound was output from the speakers of the TV the previous time, the system may not turn on by interlocking with the TV even when the TV is turned on.

**The system turns off when the TV is turned off.**

- Check the setting of the Control for HDMI function. When the Control for HDMI function is set to on and the input of the system is the TV input, the system turns off automatically when you turn off the TV.

**The system does not turn off even when the TV is turned off.**

- Check the setting of the Control for HDMI function. When you turn off the TV, the system turns off automatically only if the input of the system is TV input. The TV must support the Control for HDMI function. For details, refer to the operating instructions of your TV.

#### Picture

**There is no picture or the picture is not output correctly.**

- Select the appropriate input.
- When there is no picture while TV input is selected, select the TV channel that you want when the TV remote control.
- Disconnect an HDMI cable, then connect it again. Make sure that the cable is firmly inserted.

#### Sound

**No TV sound is output from the system.**

- Check the type and connection of an HDMI cable or optical digital cable that is connected to the system and the TV (refer to the supplied StartUp Guide).
- Disconnect the cables that are connected between the TV and the system, then connect them firmly again. Disconnect the AC power cords (mains leads) of the TV and the system from the AC outlets (mains), then connect them again.
- When the system and TV are connected with an HDMI cable, check the following.
  - The HDMI jack of the connected TV is labeled with “ARC”.
  - The Control for HDMI function of the TV is set to on.
  - On the system, the Control for HDMI function is set to on.

- If your TV is not compatible with Audio Return Channel, connect the optical digital cable (refer to the supplied StartUp Guide). If the TV is not compatible with Audio Return Channel, TV sound will not be output from the system even if the system is connected to the TV’s HDMI IN jack.
- If the sound of the device that is connected to the optical input jack of the TV is not output, try the following.
  - Connect the cable box or satellite box directly to the TV IN (OPTICAL) jack of the system.
- Press **INPUT** repeatedly to select the TV input.
- Increase the volume on the TV or cancel muting.
- Depending on the order in which you turn on the TV and the system, the system may be muted. If this happens, turn on the TV first, then the system.

- Set the speakers setting of the TV (BRAVIA) to Audio System. Refer to the operating instructions of your TV regarding how to set the TV.
- Check the sound output of the TV. Refer to the operating instructions of the TV for the TV settings.
- The system supports the Dolby Digital and PCM audio formats. When you play back an unsupported format, set the digital audio out setting of the TV (BRAVIA) to “PCM.” For details, refer to the operating instructions of your TV.

**The sound is output from both the system and the TV.**

- Change the audio output setting of the TV so that the TV sound is output from the external speaker.
- Set the TV volume to minimum.

**No sound or only a very low-level sound is heard from the subwoofer.**

- Make sure the AC power cord (mains lead) of the subwoofer is connected properly (refer to the supplied StartUp Guide).
- Press **SW** ↶ + to increase the subwoofer volume.
- A subwoofer is for reproducing bass sound. If the input sources contain very little bass sound components (i.e., a TV broadcast), the sound from the subwoofer may be difficult to hear.
- When you play content compatible with copyright protection technology (HDCP), it is not output from the subwoofer.

**No sound or only a very low-level sound of the device connected to the system is heard from the system.**

- Press ↶ + and check the volume level.
- Press ⏏ or ↶ + to cancel the muting function.
- Make sure the input source is selected correctly. You should try other input sources by pressing **INPUT** repeatedly.
- Check that all the cables and cords of the system and the connected device are firmly inserted.
- If the connected device supports the up-sampling feature, you need to turn it off.
- No sound or only very low-level sound is heard from the surround speakers.**
  - Make sure that the cables of the surround speakers are connected properly to the subwoofer (refer to the supplied StartUp Guide).
  - Check that [SPEAKER] – [MULTI SPEAKER] is set to [ON]. If [SPEAKER] – [MULTI SPEAKER] is set to [OFF], the sound is not output from the surround speakers when playing the sound of 2-channel source.
- Multi-channel sound which has not been recorded as surround sound is not output from the surround speakers.

**The surround effect cannot be obtained.**

- Depending on the input signal and the sound mode setting, surround sound processing may not work effectively. The surround effect may be subtle, depending on the program or disc.
- To play multi channel audio, check the digital audio output setting on the device connected to the system. For details, refer to the operating instructions supplied with the connected device.

#### USB Device Connection

**The USB device is not recognized.**

- Try the following:
  - ⊗ Turn the system off.
  - ⊗ Remove and reconnect the USB device.
  - ⊗ Turn the system on.
- Make sure that the USB device is securely connected to the ↕ (USB) port.
- Check to see if the USB device or a cable is damaged.
- Make sure that the USB device is on.
- If the USB device is connected via a USB hub, disconnect it and connect the USB device directly to the subwoofer.

#### Mobile Device Connection

**BLUETOOTH connection cannot be completed.**

- Make sure that the BLUETOOTH indicator on the subwoofer is lit.
- Make sure the BLUETOOTH device to be connected is turned on and the BLUETOOTH function is enabled.
- Bring the BLUETOOTH device close to the subwoofer.
- Pair this system and the BLUETOOTH device again. You may need to cancel the pairing with this system using your BLUETOOTH device first.
- If [BT] – [POWER] is set to [OFF], set to [ON].

**Pairing cannot be achieved.**

• Bring the BLUETOOTH device close to the subwoofer.

- Make sure this system is not receiving interference from a wireless LAN device, other 2.4 GHz wireless devices, or a microwave oven. If a device that generates electromagnetic radiation is nearby, move the device away from this system.

- Pairing may not be possible if other BLUETOOTH devices are present around the system. In this case, turn off the other BLUETOOTH devices.

**Sound of the connected BLUETOOTH mobile device is not output from the system.**

- Make sure that the BLUETOOTH indicator on the subwoofer is lit.
- Bring the BLUETOOTH device close to the subwoofer.
- If a device that generates electromagnetic radiation, such as a wireless LAN device, other BLUETOOTH devices, or a microwave oven is nearby, move the device away from this system.
- Move the USB 3.0 device and its cable away from this system.

- Remove any obstacle between this system and the BLUETOOTH device or move this system away from the obstacle.

- Reposition the connected BLUETOOTH device.
  - Switch the wireless LAN frequency of any nearby wireless LAN router or PC to 5 GHz range.
- Increase the volume on the connected BLUETOOTH device.

**The sound is not in sync with the image.**

- When you are watching movies, you may hear the sound with a slight delay from the image.

#### Remote Control

**The remote control of this system does not function.**

- Point the remote control at the remote control sensor on the subwoofer.
- Remove any obstacles in the path between the remote control and the subwoofer.
- Replace both batteries in the remote control with new ones, if they are weak.
- Make sure you are pressing the correct button on the remote control.

**The TV remote control does not work.**

- Install the bar speaker so that it does not obstruct the remote control sensor of the TV.

#### Others

**The Control for HDMI function does not work properly.**

- Check the connection with the system (refer to the supplied StartUp Guide).
- Enable the Control for HDMI function on the TV. For details, refer to the operating instructions of your TV.
- Wait a while, and then try again. If you unplug the system, it will take a while before operations can be made. Wait for 15 seconds or longer, and then try again.
- Make sure the devices connected to the system support the Control for HDMI function.
- Enable the Control for HDMI function of the devices connected to the system. For details, refer to the operating instructions of your device.
  - The type and number of devices that can be controlled by the Control for HDMI function is restricted by the HDMI CEC standard as follows:
    - Recording devices (Blu-ray Disc recorder, DVD recorder, etc.): up to 3 devices
    - Playback devices (Blu-ray Disc player, DVD player, etc.): up to 3 devices
    - Tuner-related devices: up to 4 devices
    - Audio system (receiver/ headphone): up to 1 device (used by this system)

**[PROTECT] appears in the front panel display of the subwoofer, the sound is muted, and buttons on the remote control or subwoofer other than ↶ (power) do not work.**

- The protection feature is activated. Press ↶ (power) to turn the system off and disconnect the AC power cord (mains lead) and check the items below.
  - Make sure that the ventilations of the subwoofer are not covered and turn on the system after a while.
  - When the system is using the USB connection, remove the USB device and turn on the system. If the system operates properly, the current of the connected USB device is over the maximum output current of the system (500 mA, or the USB device may have an abnormality).

**The front panel display of the subwoofer is not lit.**

- Press **DIMMER** to set the brightness to [BRIGHT] or [DARK] if set to [OFF].

**Sensors of the TV do not work properly.**

- The bar speaker may block some sensors (such as the brightness sensor), the remote control receiver of your TV or the emitter for 3D glasses (infrared transmission) of a 3D TV that supports the infrared 3D glass system, or wireless communication. Move the bar speaker away from the TV within a range that allows those parts to operate properly. For the locations of the sensors and remote control receiver, refer to the operating instructions supplied with the TV.

**The system does not work properly ([.DEMO] appears in the front panel display).**

- The system is in demo mode. To cancel demo mode, reset the system. Press and hold ↶ (power) and – (volume) on the subwoofer for more than 5 seconds.

**When you change to the TV input from the USB input by pressing INPUT, the message appears.**

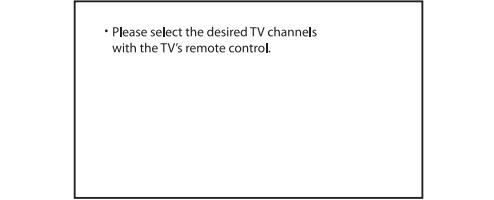

- \* This screen is an example for English.
- Select the TV program by using the TV remote control.

## Specifications

#### Subwoofer (SA-WS20R)

**Amplifier section**  
**POWER OUTPUT** (rated)  
Front R: 45 W + 45 W (at 4 ohms, 1kHz, 1% THD)  
**POWER OUTPUT** (reference)  
Front L/Front/Surround L/Surround R/Center: 67 W (per channel at 4 ohms, 1kHz)  
Subwoofer: 65 W (at 4 ohms, 100 Hz)

**Input**  
TV IN (OPTICAL)  
USB  
ARC/DIG IN

Output  
HDMI OUT (TV ARC)

**HDMI Section**  
Connector  
Type A (19pin)

**USB section**  
↕ (USB) port:

**BLUETOOTH section**  
Communication system  
BLUETOOTH Specification version 5.0  
Output  
BLUETOOTH Specification Power Class 1  
Maximum communication range  
Line of sight approx. 10 m\*  
Frequency band  
2.4 GHz band (2-4000 Hz - 2.4835 GHz)  
Modulation method  
FHSS (Frequency Hopping Spread Spectrum)  
Compatible BLUETOOTH profiles\*  
A2DP (Advanced Audio Distribution Profile)  
AVRCP (Audio Video Remote Control Profile)  
Supported Codes\*\*  
SBC\*  
Transmission range (A2DP)  
20 Hz - 20,000 Hz (Sampling frequency 32 kHz, 44.1 kHz, 48 kHz)  
\* The actual range will vary depending on factors such as obstacles between devices, magnetic fields around a microwave oven, static electricity, cordless phone use, reception sensitivity, the operating system, software applications, etc.  
\*\* BLUETOOTH standard profiles indicate the purpose of BLUETOOTH communication between devices.

◆ Codes: Audio signal compression and conversion format  
◆ Abbreviation for Subband Codec.

**Speaker system**

Speaker system  
Subwoofer system, Bass reflex  
Speaker

160 mm cone type

#### General

Power requirements  
Models for Middle East and Africa:  
120 V ~ 240 V AC, 50 Hz/60 Hz  
Models for other countries/regions:  
220 V ~ 240 V AC, 50 Hz/60 Hz  
Power consumption  
On: 40 W  
Standby mode: 0.5 W or less (Power Saving mode)  
When [CONTROL FOR HDMI] = [HDMI] and [STANBY] in [BT] are set to [OFF]  
Standby modes: 2 W or less\*  
(When [CONTROL FOR HDMI] = [HDMI] and [STANBY] in [BT] are set to [ON])  
\* The system will automatically enter Power saving mode when there is no HDMI connection and no BLUETOOTH pairing history.

Dimensions (approx.) (w/h/d)  
192 mm × 387 mm × 342 mm  
\* Not including projection portion  
Mass (approx.)  
7.0 kg

#### Bar Speaker (SS-S20R)

Speaker system

Full range speaker system, Bass reflex

Speaker

65 mm cone type

Dimensions (approx.) (w/h/d)

88 mm × 117 mm × 86 mm

\* Not including projection portion

Mass (approx.)

0.6 kg

Design and specifications are subject to change without notice.

## Playable Types of Files (USB Input)

Codec	Extension
MP3 (MPPEG-1 Audio Layer III)	.mp3
WMA9 Standard	.wma
LPCM (2ch)	.wav