

Data Projector

Safety Regulations

Before operating the unit, please read this manual thoroughly and retain it for future reference.

When using the product, do not use it for purposes other than those described in the instruction manual.

Manuals supplied

Safety Regulations (this document)

Explains the safety precautions for this unit.

Help Guide (Web operating instructions)

Explains the features of the unit and how to use in detail.

You can view the Help Guide on a smartphone or computer.

<https://rd1.sony.net/help/vpl/gtz380/en/>



For the customers in the U.S.A.

Please read "Risk Group 3 Safety for the Customers in the U.S.A." in the Help Guide as well.

VPL-GTZ380

© 2020 Sony Corporation Printed in Japan



5023480110

WARNING

To reduce the risk of fire or electric shock, do not expose this apparatus to rain or moisture.

To avoid electrical shock, do not open the cabinet. Refer servicing to qualified personnel only.

WARNING

This apparatus must be earthed.

WARNING

When installing the unit, incorporate a readily accessible disconnect device in the fixed wiring, or connect the power plug to an easily accessible socket-outlet near the unit. If a fault should occur during operation of the unit, operate the disconnect device to switch the power supply off, or disconnect the power plug.

CAUTION

For safety, do not connect the connector for peripheral device wiring that might have excessive voltage to the following port:

- LAN

WARNING

- Use the approved Power Cord (3-core mains lead) / Appliance Connector / Plug with earthing-contacts that conforms to the safety regulations of each country/region if applicable.
- Use the Power Cord (3-core mains lead) / Appliance Connector / Plug conforming to the proper ratings (Voltage, Ampere).

If you have questions on the use of the above Power Cord / Appliance Connector / Plug, please consult a qualified service personnel.

CAUTION

- Danger of explosion if battery is incorrectly replaced. Replace only with the same or equivalent type recommended by the manufacturer.

- When you dispose of the battery or the product, you must obey the law in the corresponding area or country. Do not dispose of the battery or the product in a fire or a hot oven, or mechanically crush or cut the battery. It may explode or cause a fire. Do not subject the battery to extremely low air pressure that may result in an explosion or the leakage of flammable liquid or gas.
- Do not place the battery in a high temperature place, such as under direct sunlight or near fire. It may ignite, explode, or cause a fire. Do not immerse or wet the battery in water or seawater. This may cause an electric shock.

CAUTION

The following size and number of batteries are required for the remote control.

- Size: AA (R6)
- Number of battery(ies): Two pieces

To avoid risk of explosion, use only the following type of battery.

- Manganese or alkaline batteries

For the customers in the U.S.A.

This equipment has been tested and found to comply with the limits for a Class B digital device, pursuant to part 15 of the FCC Rules. These limits are designed to provide reasonable protection against harmful interference in a residential installation. If this equipment generates, uses and can radiate radio frequency energy and, if not installed and used in accordance with the instructions, may cause harmful interference to radio communications. However, there is no guarantee that interference will not occur in a particular installation. If this equipment does cause harmful interference to radio or television reception, which can be determined by turning the equipment off and on, the user is encouraged to try to correct the interference by one or more of the following measures:

- Reorient or relocate the receiving antenna.
- Increase the separation between the equipment and receiver.
- Connect the equipment into an outlet on a circuit different from that to which the receiver is connected.
- Consult the dealer or an experienced radio/TV technician for help.

You are cautioned that any changes or modifications not expressly approved in this manual could void your authority to operate this equipment.

All interface cables used to connect the equipment to peripherals must be shielded type to comply with EMC standard(s) and to prevent undesired operation due to radiated emissions. When cables are supplied, always use them for this purpose.

If you have any questions about this product, you may call: Sony Customer Information Service Center 1-800-222-7669 or <http://www.sony.com/>

Supplier's Declaration of Conformity	
Trade Name:	SONY
Model:	VPL-GTZ380
Responsible party:	Sony Electronics Inc.
Address:	16535 Via Esprillo, San Diego, CA 92127 U.S.A.
Telephone Number:	858-942-2230
This device complies with part 15 of the FCC Rules. Operation is subject to the following two conditions: (1) This device may not cause harmful interference, and (2) this device must accept any interference received, including interference that may cause undesired operation.	

For the customers in Canada

CAN ICES-3 (B)/NMB-3(B)

For kundene i Norge

Dette utstyret kan kobles til et IT-strømfordelingssystem.

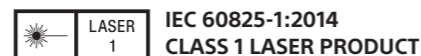

WARNING

LASER ENERGY EXPOSURE NEAR APERTURE MAY CAUSE BURNS

CAUTION

Do not look into the lens while in use.

CAUTION

Use of controls or adjustments or performance of procedures other than those specified herein may result in hazardous radiation exposure.

CAUTION

The use of optical instruments with this product will increase eye hazard.

This product according to the IEC 62471-5:2015 becomes Risk Group 3 (RG3).

WARNING

- No direct exposure to the beam shall be permitted.
- Operators shall control access to the beam within the hazard distance or install the product at the height that will prevent spectators' eyes from being in the hazard distance.

CAUTION

Only personnel authorized by Sony are allowed to install and operate this product or perform services for this product.

For details, consult with your local Sony Authorized Dealer or qualified Sony personnel.

For secure installation

- The product should be installed by professionals authorized by Sony.
- The product should be installed in an area secured with locks or other security systems.

For the customers in the U.S.A.

When installing the product in non-cinema theaters:

- The product should be installed in a location where the lowest tip of the Hazard area is no lower than 3 m measured vertically above the floor.
- Horizontal clearance to the Hazard area should be 2.5 m measured horizontally and/or installed with physical barriers to avoid unintentional access to the area so that no one enters the Hazard area.

For the customers in other countries

The product should be installed in a location where a sufficient height (2.5 m or higher) is ensured above floor level and/or installed with physical barriers to avoid unintentional access to the area so that no one enters the Hazard Area.

For secure operation

- The product should be operated by administrators authorized by Sony.
- Administrators should limit access of people to the Hazard Area.
- If someone unavoidably enters the Hazard Area, turn off the product, cut off the image, or perform other operations to avoid eye injuries.

For secure service

- Services for this product should be performed by qualified service personnel authorized by Sony.

För kunderna i Sverige

Denna produkt, enligt IEC 62471-5:2015, tillhör riskgrupp 3 (RG3).

WARNING

- Ingen direktexponering för strålen får tillåtas.
- Operatörer ska kontrollera åtkomst till strålen inom riskavståndet eller installera produkten på en höjd som förhindrar att åskådares ögon befinner sig inom riskavståndet.

FÖRSIKTIGHET

Endast personal som auktoriserats av Sony får installera och använda denna produkt eller utföra service på produkten.

Rådfråga din lokala behöriga Sony-återförsäljare eller kvalificerade Sony-personal för mer information.

För säker installation

- Produkten bör installeras av yrkesmän som godkänts av Sony.
- Produkten bör installeras på en plats som är säkrad med lås eller andra säkerhetssystem.
- Produkten bör installeras på en plats som är tillräckligt högt (minst 2,5 m) ovanför golvnivån och/eller installeras med fysiska barriärer för att undvika oavsiktlig åtkomst till riskområdet.

För säker manövrering

- Produkten bör manövreras av administratörer som godkänts av Sony.
- Administratörer bör begränsa åtkomst till riskområdet för andra personer.
- Om någon person oundvikligen träder in i riskområdet ska produkten stängas av, bilden brytas eller andra åtgärder utföras för att undvika ögonskador.

För säker service

- Service på denna produkt bör utföras av behörig personal som auktoriserats av Sony.

Hazard Distance and Area

Top view

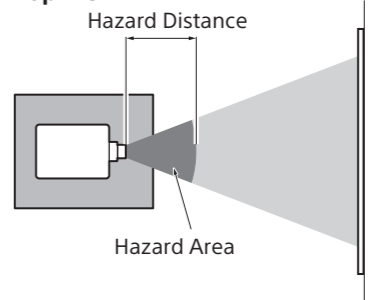

For the customers in the U.S.A.

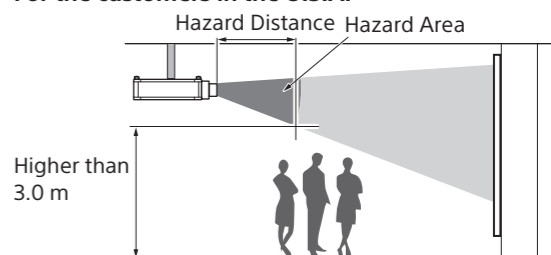

For the customers in other countries

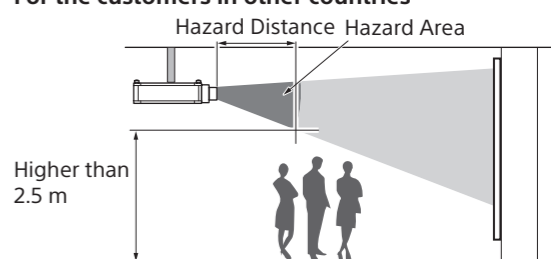

Hazard Distance values of each interchangeable lenses of this product

For the customers in the U.S.A.

✓: permitted —: prohibited

Lens type	Throw ratio ^{*1}	Hazard Distance Unit: m (inches)	Table Top Installation	Ceiling Installation
VPLL-Z8008	0.8-1.02	Not available (RG2)	✓	✓
VPLL-Z8014	1.4	1.7 (66 15/16) (RG3)	—	✓
	1.4-1.6	1.8 (70 7/8) (RG3)	—	✓
	1.6-1.8	1.9 (74 13/16) (RG3)	—	✓
	1.8-2.2	2.0 (78 3/4) (RG3)	—	✓
	2.2-2.73	2.1 (82 11/16) (RG3)	—	✓

For the customers in other countries

✓: permitted —: prohibited

Lens type	Throw ratio ^{*1}	Hazard Distance Unit: m (inches)	Table Top Installation	Ceiling Installation
VPLL-Z8008	0.8-1.02	Not available (RG2)	✓	✓
VPLL-Z8014	1.4-1.6	Not available (RG2)	✓	✓
	1.6-1.7	1.1 (43 5/16) (RG3)	—	✓
	1.7-1.9	1.2 (47 1/4) (RG3)	—	✓
	1.9-2.1	1.3 (51 3/16) (RG3)	—	✓
	2.1-2.3	1.4 (55 1/8) (RG3)	—	✓
	2.3-2.5	1.5 (59 1/16) (RG3)	—	✓
	2.5-2.73	1.6 (63) (RG3)	—	✓

*1 Value dividing screen size (H) by projection distance
The throw ratio is determined depending on the projector with which each lens is used.

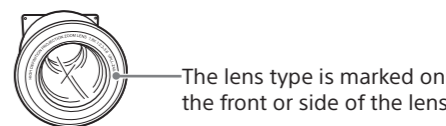

Riskavstånd och -område

Vy ovanifrån

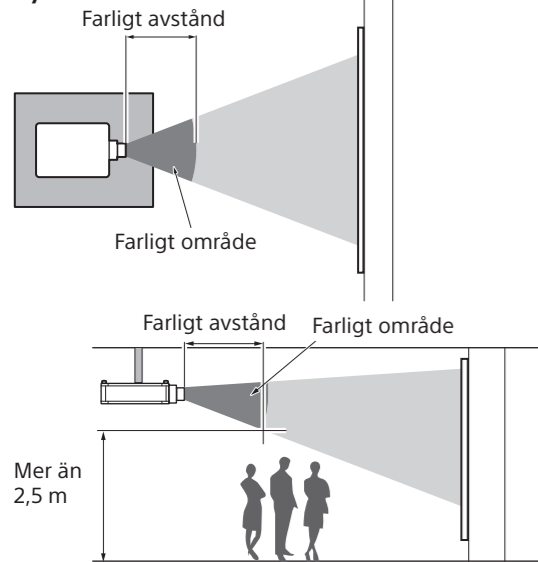

Riskavståndets värden när det gäller denna produkts utbytbara objektiv

✓: tillåtet —: förbjudet

Objektiv-typ	Projicerings-förhållande ¹	Farligt avstånd Måttenhet: m	Bords-installation	Tak-installation
VPLL-Z8008	0,8-1,02	Ej tillgängligt (RG2)	✓	✓
VPLL-Z8014	1,4-1,6	Ej tillgängligt (RG2)	✓	✓
	1,6-1,7	1,1 (RG3)	—	✓
	1,7-1,9	1,2 (RG3)	—	✓
	1,9-2,1	1,3 (RG3)	—	✓
	2,1-2,3	1,4 (RG3)	—	✓
	2,3-2,5	1,5 (RG3)	—	✓
	2,5-2,73	1,6 (RG3)	—	✓

¹ Värdet är skärmstorlek (H) delat med projiceringsavstånd. Projiceringsförhållandet avgörs beroende på vilken projektor som objektivet används tillsammans med.

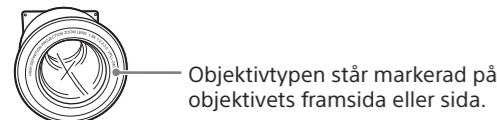

Objektivtypen står markerad på objektivets framsida eller sida.

Location information of the labels

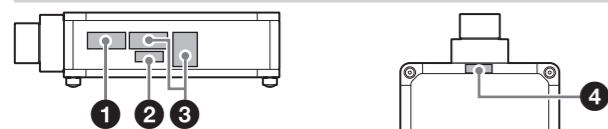

1 LABEL (for service personnel)

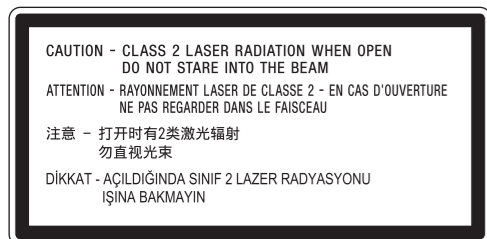

2 CLASS 1 LABEL

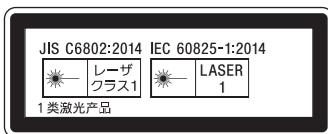

3 RG LABEL

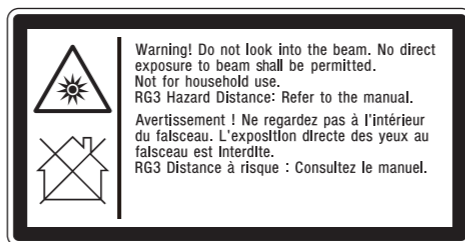

4 BURNS WARNING LABEL



Light source specifications

5.2 W laser diodes × 96 (Wavelength: 449 - 461 nm)

4.2 W laser diodes × 24 (Wavelength: 459 - 471 nm)

1.8 W laser diodes × 48 (Wavelength: 635 - 647 nm)

Beam divergence angle from lens of this unit

Lens	Zoom maximum: α	Zoom minimum: α
VPLL-Z8008	64°	52°
VPLL-Z8014	39°	21°

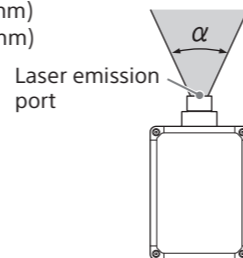

The distance L' between the front of the lens (center) and the front of the cabinet

Unit: mm (inches)

Lens	L'
VPLL-Z8008	175 (6 7/8) (Tele) to 184 (7 1/4) (Wide)
VPLL-Z8014	173 (6 13/16)

Türkiye'deki müşteriler için AEEE Yönetmeliğine Uygundur

For the customers in the U.S.A. SONY LIMITED WARRANTY - Please visit <http://www.sony.com/psa/warranty> for important information and complete terms and conditions of Sony's limited warranty applicable to this product.

For the customers in Canada SONY LIMITED WARRANTY - Please visit <http://www.sonybiz.ca/pro/lang/en/ca/article/resources-warranty> for important information and complete terms and conditions of Sony's limited warranty applicable to this product.

For the customers in Europe Sony Professional Solutions Europe - Standard Warranty and Exceptions on Standard Warranty. Please visit https://pro.sony/en_GB/support-services/warranty/support-professional-solutions-europe-standard-product-warranty for important information and complete terms and conditions.

For the customers in Korea SONY LIMITED WARRANTY - Please visit <http://bpeng.sony.co.kr/handler/BPAS-Start> for important information and complete terms and conditions of Sony's limited warranty applicable to this product.

Precautions

On safety

- Check that the operating voltage of your unit is identical with the voltage of your local power supply.
- Should any liquid or solid object fall into the cabinet, unplug the unit and have it checked by qualified personnel before operating it further.
- Unplug the unit from the wall outlet if it is not to be used for several days.
- To disconnect the cord, pull it out by the plug. Never pull the cord itself.
- The wall outlet should be near the unit and easily accessible.

- The unit is not disconnected to the AC power source (mains) as long as it is connected to the wall outlet, even if the unit itself has been turned off.
- Do not look into the lens while in use.
- Do not place your hand or objects near the ventilation holes. The air coming out is hot.
- When attaching or removing the lens, be sure to consult with qualified Sony personnel.

On preventing internal heat build-up

After you turn off the power with the I/⏻ (On/Standby) button, do not disconnect the unit from the wall outlet while the cooling fan is still running.

Caution

This unit is equipped with ventilation holes (intake/exhaust). Do not block or place anything near these holes, or internal heat build-up may occur, causing picture degradation or damage to the unit.

On repacking

Save the original shipping carton and packing material; they will come in handy if you ever have to ship your unit. For maximum protection, repack your unit as it was originally packed at the factory.

On watching 3D video images

Safety precautions

- If you observe flickering or flashing, turn off the lighting in the room.
- Not for use by children without proper adult supervision.

On inspection of light source related parts

Since the unit uses a laser, when adjusting or inspecting the light source related parts, particular attention and a safe environment are necessary. Be sure to consult with qualified Sony personnel (charged).

On heat dissipation

The temperature of the projector cabinet may increase during or immediately after use; however, this is not a malfunction.

Notes on Installation and Usage

Unsuitable installation

Do not place the unit in the following situations, which may cause malfunction or damage to the unit.

Near walls

To maintain the performance and reliability of the unit, leave space between walls and the unit as illustrated.

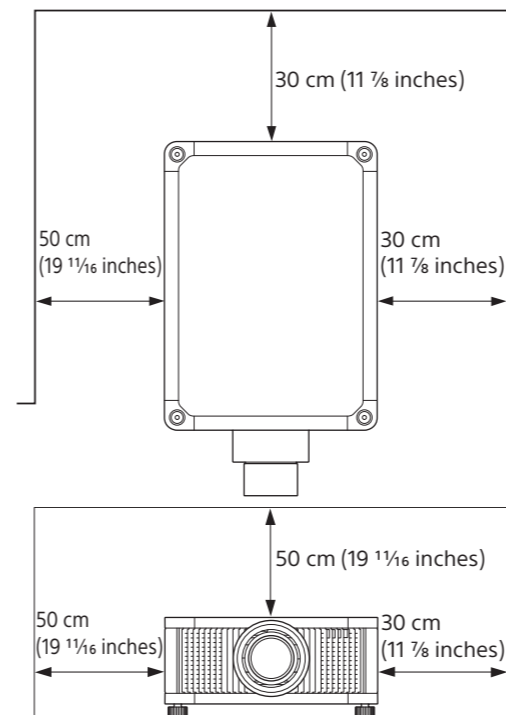

Note that the wall on the ventilation holes side may become hot.

Air from air conditioners or the ventilation holes of this unit or other devices, may cause oscillation on the screen. Be sure not to install this unit in the area where the air from air conditioners or the ventilation holes of these devices reach to the front side of this unit.

Poorly ventilated location

Leave space of more than 30 cm (11 7/8 inches) from the top or front of the unit.

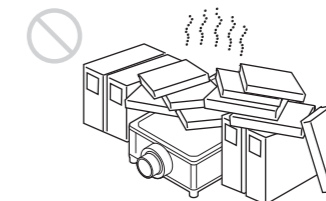

Hot and humid

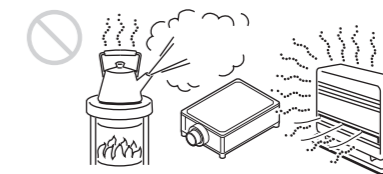

Locations subject to direct cool or warm air from an air-conditioner

Installing the unit in such a location may cause a malfunction of the unit due to moisture condensation or rise in temperature.

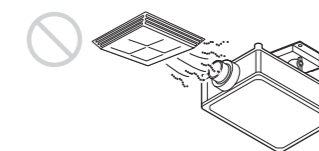

Near a heat or smoke sensor

Malfunction of the sensor may occur.

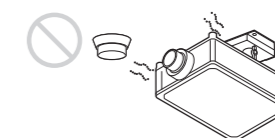

Very dusty and extremely smoky locations

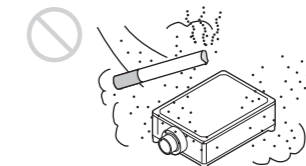

Unsuitable Conditions

Do not do any of the following while using the unit.

Blocking the ventilation holes (intake or exhaust)

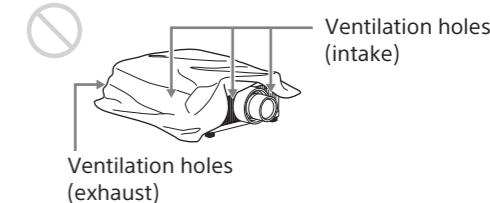

When installing the unit at high altitudes

When using the unit in a location at an altitude of 1,000 m (approx. 3,280 feet) or higher, appropriately set "High Altitude Mode" in the Setup menu. Failing to do so could have adverse effects, such as reducing the reliability of certain components.

Safety precautions for installing the unit on a ceiling

- Never mount the projector on the ceiling or move it by yourself. Be sure to consult with qualified Sony personnel (charged).
- When installing the unit on a ceiling, be sure to use a safety wire, etc., to prevent the unit from falling. Entrust the installation to an experienced contractor or installer.

For dealers

- When the projector is mounted on the ceiling, a Sony bracket or recommended equivalent must be used for installation.
- Be sure to secure the cabinet cover firmly when installing to the ceiling firmly.